



Aswath Damodaran

VALUATION: ART, SCIENCE OR MAGIC?

Aswath Damodaran
www.damodaran.com

Some Initial Thoughts

" One hundred thousand lemmings cannot be wrong"

Graffiti

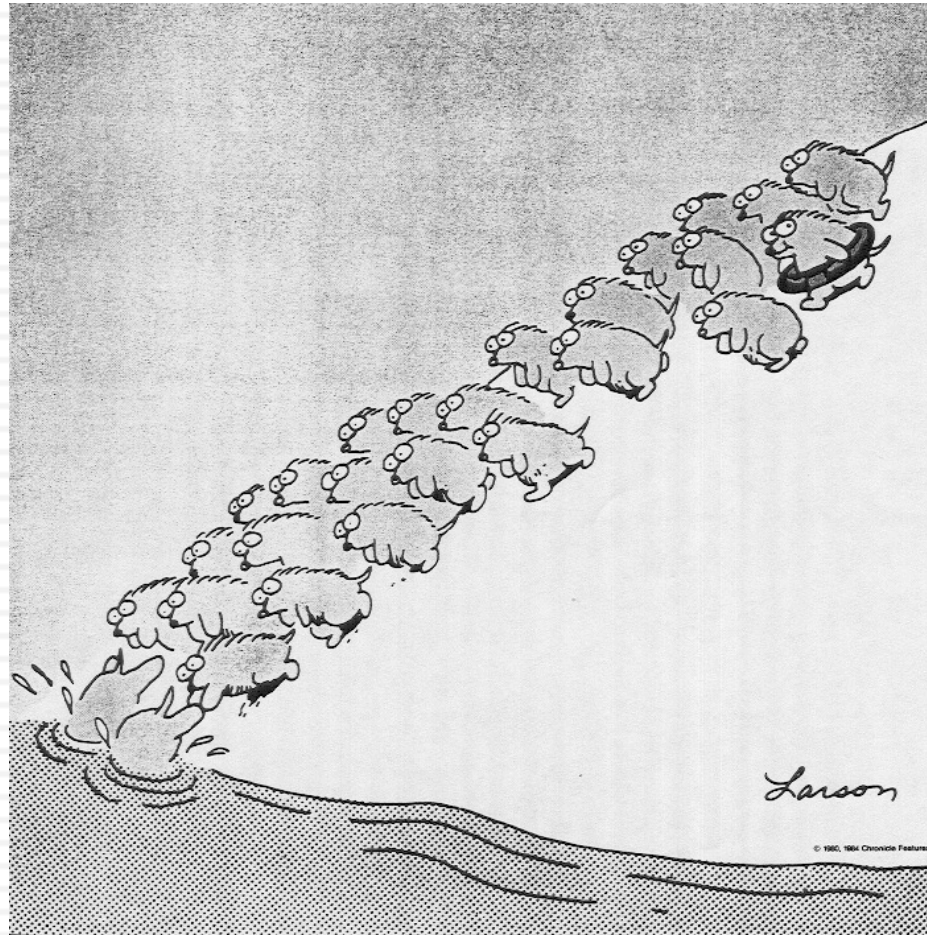

Aswath Damodaran

Theme 1: Characterizing Valuation as a discipline

- In a science, if you get the inputs right, you should get the output right. The laws of physics and mathematics are universal and there are no exceptions. **Valuation is not a science.**
- In an art, there are elements that can be taught but there is also a magic that you either have or you do not. The essence of an art is that you are either a great artist or you are not. **Valuation is not an art.**
- A craft is a skill that you learn by doing. The more you do it, the better you get at it. **Valuation is a craft.**

Theme 2: Valuing an asset is not the same as pricing that asset

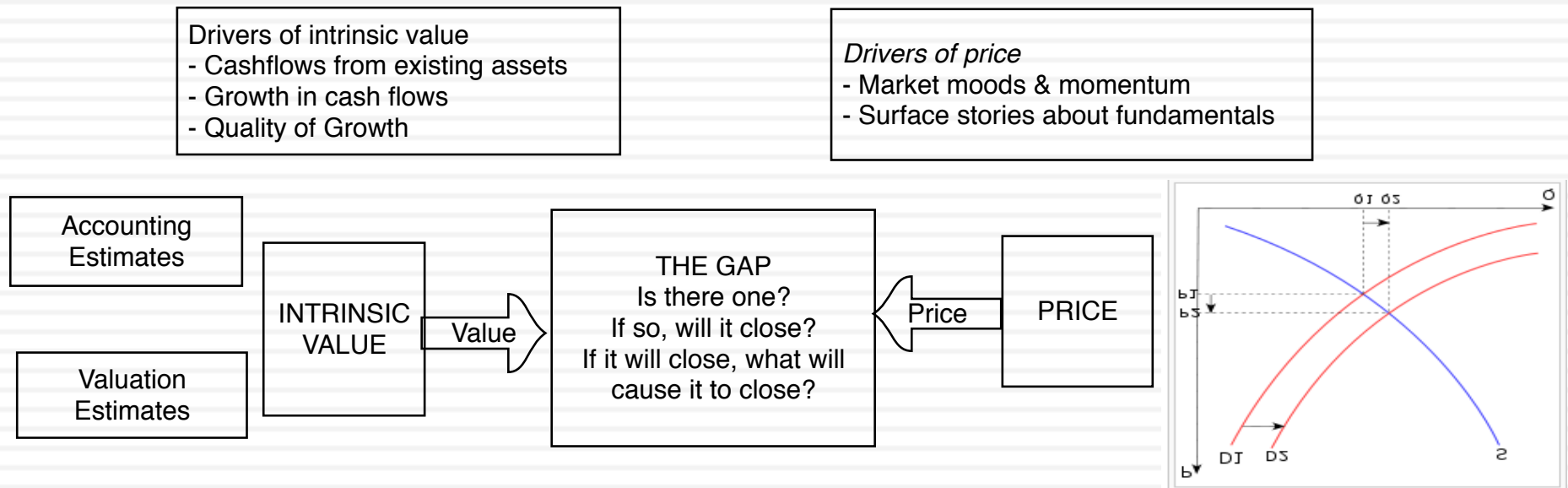

Theme 3: Good valuation = Story + Numbers

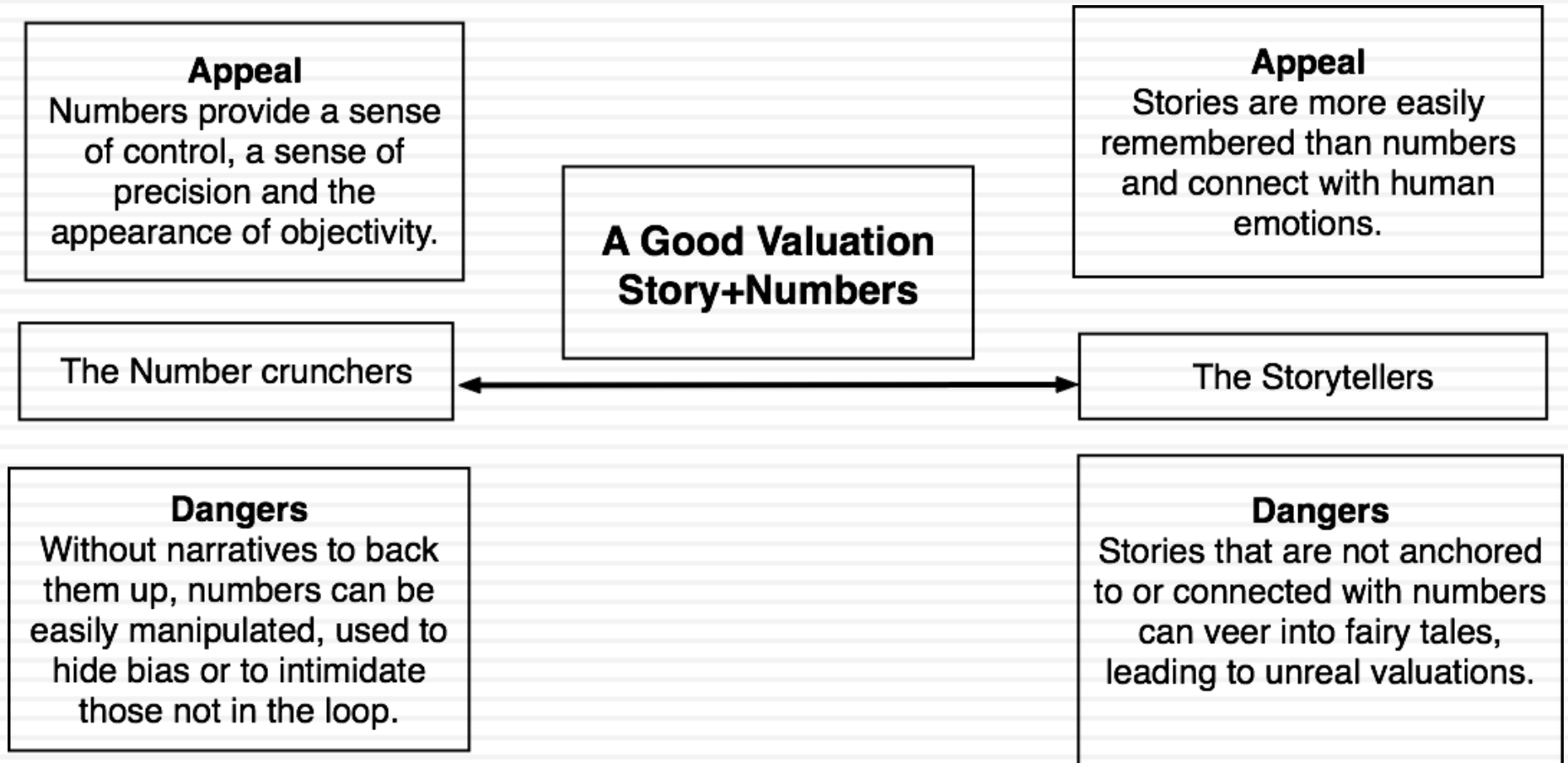

Theme 4: If you value something, you should be willing to act on it..

- What theory? There is very little theory in valuation and I am not sure what an academic valuation would like like and am not sure that I want to find out.
- Pragmatism, not purity: The end game is to estimate a value for an asset. I plan to get there, even if it means taking short cuts and making assumptions that would make purists blanch.
- Faith: To act on your valuations, you have to have faith in
 - ▣ In your own valuation judgments.
 - ▣ In markets: that prices will move towards your value estimates.That faith will have to be earned and will be tested.

Misconceptions about Valuation

- Myth 1: A valuation is an objective search for “true” value
 - Truth 1.1: All valuations are biased. The only questions are how much and in which direction.
 - Truth 1.2: The direction and magnitude of the bias in your valuation is directly proportional to who pays you and how much you are paid.
- Myth 2.: A good valuation provides a precise estimate of value
 - Truth 2.1: There are no precise valuations.
 - Truth 2.2: The payoff to valuation is greatest when valuation is least precise.
- Myth 3: . The more quantitative a model, the better the valuation
 - Truth 3.1: One’ s understanding of a valuation model is inversely proportional to the number of inputs required for the model.
 - Truth 3.2: Simpler valuation models do much better than complex ones.

Approaches to Valuation

- **Intrinsic valuation**, relates the value of an asset to the present value of expected future cashflows on that asset. In its most common form, this takes the form of a discounted cash flow valuation.
- **Relative valuation**, estimates the value of an asset by looking at the pricing of 'comparable' assets relative to a common variable like earnings, cash flows, book value or sales.
- **Contingent claim valuation**, uses option pricing models to measure the value of assets that share option characteristics.

Discounted Cash Flow Valuation

- *What is it:* In discounted cash flow valuation, the value of an asset is the present value of the expected cash flows on the asset.
- *Philosophical Basis:* Every asset has an intrinsic value that can be estimated, based upon its characteristics in terms of cash flows, growth and risk.
- *Information Needed:* To use discounted cash flow valuation, you need
 - ▣ to estimate the life of the asset
 - ▣ to estimate the cash flows during the life of the asset
 - ▣ to estimate the discount rate to apply to these cash flows to get present value
- *Market Inefficiency:* Markets are assumed to make mistakes in pricing assets across time, and are assumed to correct themselves over time, as new information comes out about assets.

Risk Adjusted Value: Three Basic Propositions

- The value of a risky asset can be estimated by discounting the expected cash flows on the asset over its life at a risk-adjusted discount rate:

$$\text{Value of asset} = \frac{E(\text{CF}_1)}{(1+r)} + \frac{E(\text{CF}_2)}{(1+r)^2} + \frac{E(\text{CF}_3)}{(1+r)^3} \dots + \frac{E(\text{CF}_n)}{(1+r)^n}$$

1. *The IT Proposition:* If “it” does not affect the cash flows or alter risk (thus changing discount rates), “it” cannot affect value.
2. *The DUH Proposition:* For an asset to have value, the expected cash flows have to be positive some time over the life of the asset.
3. *The DON'T FREAK OUT Proposition:* Assets that generate cash flows early in their life will be worth more than assets that generate cash flows later; the latter may however have greater growth and higher cash flows to compensate.

DCF Choices: Equity Valuation versus Firm Valuation

Firm Valuation: Value the entire business

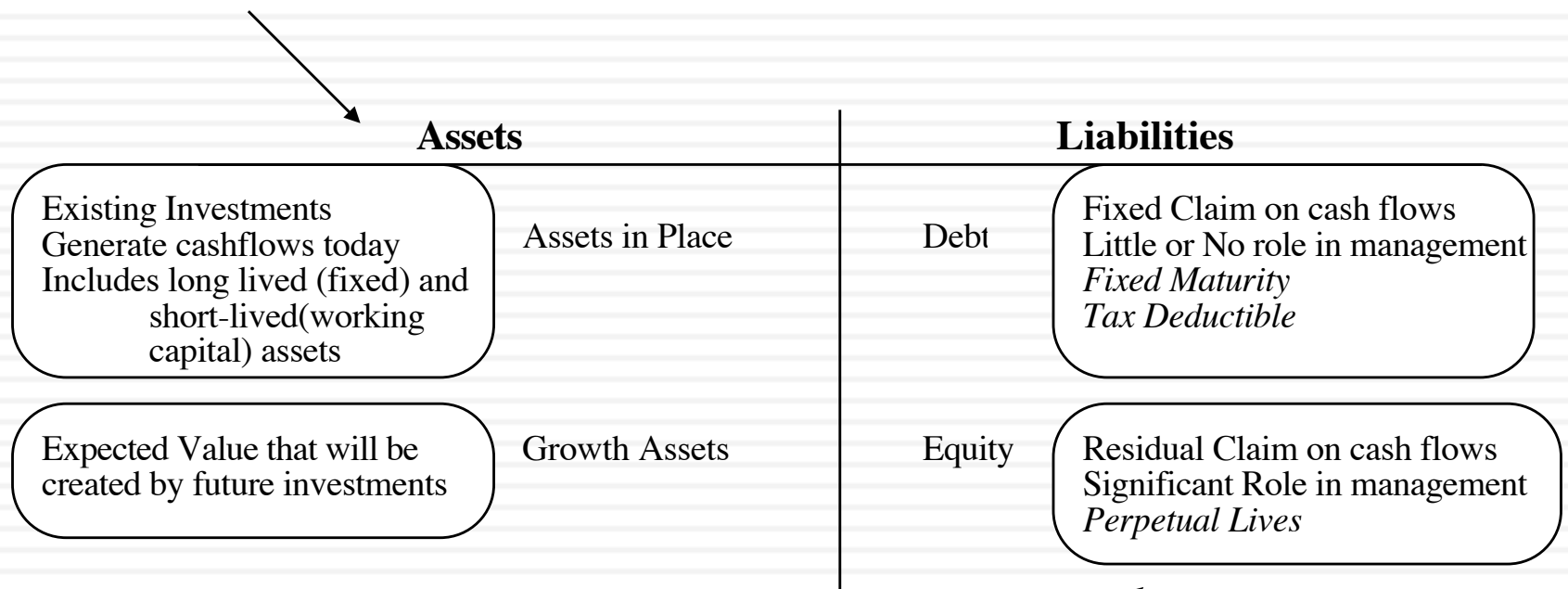

Equity valuation: Value just the equity claim in the business

The Drivers of Value...

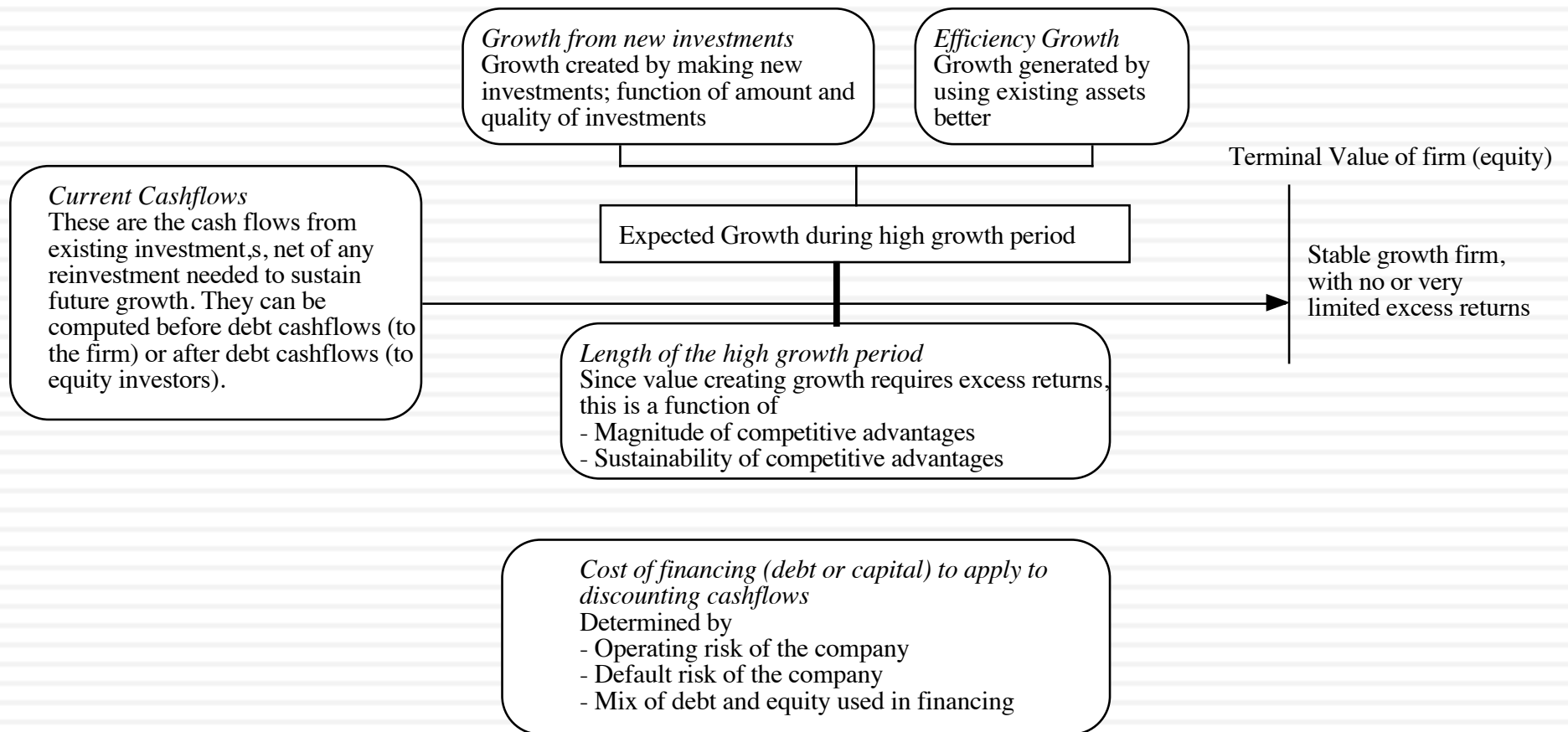

DISCOUNTED CASHFLOW VALUATION

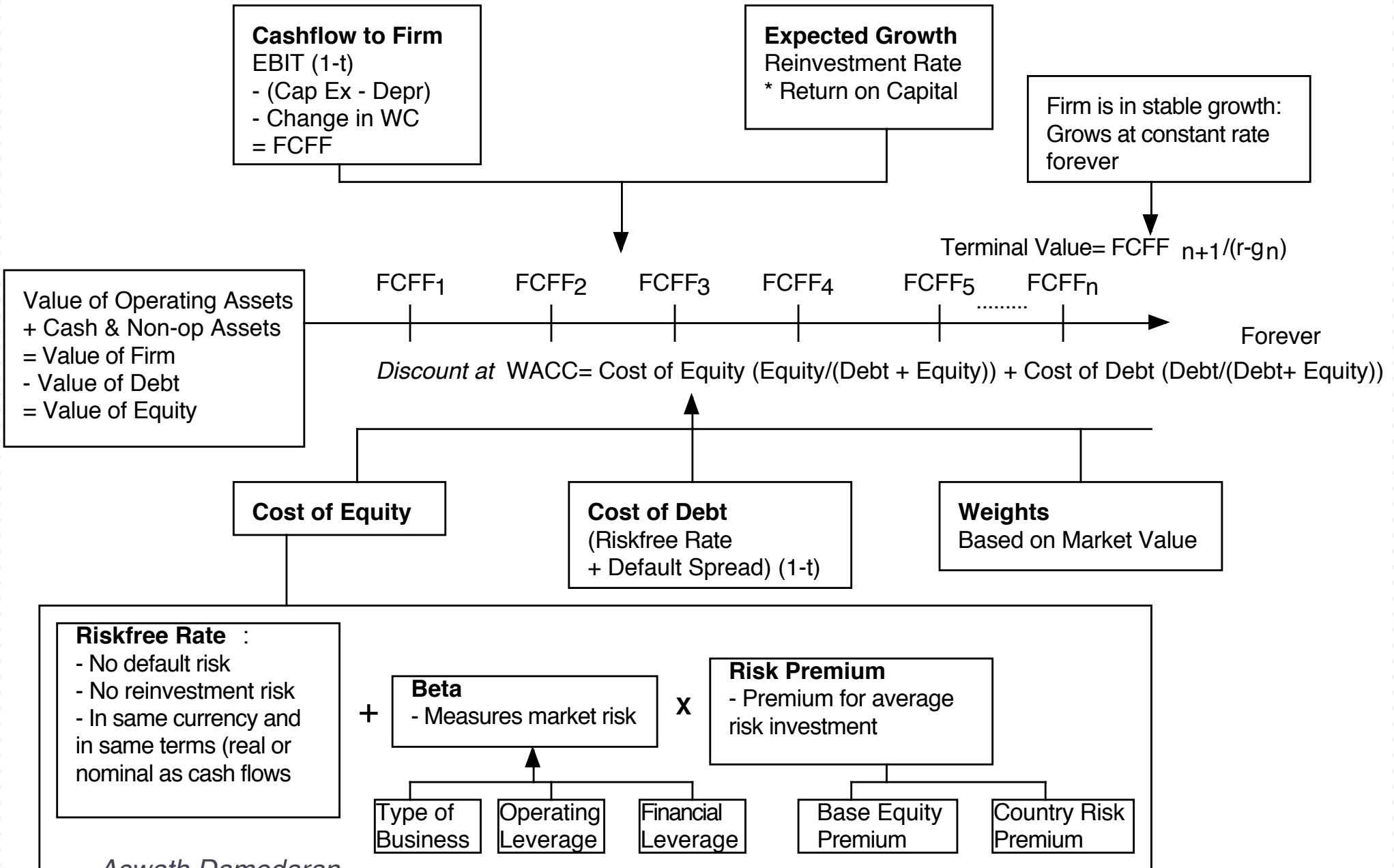

Amgen: Status Quo

Cap Ex = Acc net Cap Ex(255) + Acquisitions (3975) + R&D (2216)

Current Cashflow to Firm
 EBIT(1-t) = $.7336(1-.28) = 6058$
 - Nt CpX = 6443
 - Chg WC 37
 = FCFF - 423
 Reinvestment Rate = $6480/6058 = 106.98\%$
 Return on capital = 16.71%

Reinvestment Rate 60%

Expected Growth in EBIT (1-t)
 $.60 * .16 = .096$
9.6%

Return on Capital 16%

Stable Growth
 g = 4%; Beta = 1.10;
 Debt Ratio = 20%; Tax rate = 35%
 Cost of capital = 8.08%
 ROC = 10.00%;
 Reinvestment Rate = $4/10 = 40\%$

Terminal Value₁₀ = $7300 / (.0808 - .04) = 179,099$

First 5 years

Growth decreases gradually to 4%

Op. Assets 94214
 + Cash: 1283
 - Debt 8272
 = Equity 87226
 - Options 479
 Value/Share \$ 74.33

Year	1	2	3	4	5	6	7	8	9	10
EBIT	\$9,221	\$10,106	\$11,076	\$12,140	\$13,305	\$14,433	\$15,496	\$16,463	\$17,306	\$17,998
EBIT (1-t)	\$6,639	\$7,276	\$7,975	\$8,741	\$9,580	\$10,392	\$11,157	\$11,853	\$12,460	\$12,958
- Reinvestment	\$3,983	\$4,366	\$4,785	\$5,244	\$5,748	\$5,820	\$5,802	\$5,690	\$5,482	\$5,183
= FCFF	\$2,656	\$2,911	\$3,190	\$3,496	\$3,832	\$4,573	\$5,355	\$6,164	\$6,978	\$7,775

Term Yr
 18718
 12167
 4867
 7300

Cost of Capital (WACC) = $11.7\% (0.90) + 3.66\% (0.10) = 10.90\%$

Debt ratio increases to 20%
 Beta decreases to 1.10

On May 1, 2007, Amgen was trading at \$ 55/share

Cost of Equity 11.70%

Cost of Debt
 $(4.78\% + .85\%)(1 - .35) = 3.66\%$

Weights
 E = 90% D = 10%

Riskfree Rate:
 Riskfree rate = 4.78%

+

Beta
 1.73

x

Risk Premium
 4%

Unlevered Beta for Sectors: 1.59

D/E = 11.06%

Tata Motors: April 2010

Average reinvestment rate
from 2005-09: 179.59%;
without acquisitions: 70%

Current Cashflow to Firm

EBIT(1-t) : Rs 20,116
 - Nt CpX Rs 31,590
 - Chg WC Rs 2,732
 = FCFF - Rs 14,205
 Reinv Rate = $(31590+2732)/20116$
 = 170.61%; Tax rate = 21.00%
 Return on capital = 17.16%

Reinvestment Rate
70%

Return on Capital
17.16%

Expected Growth =
 $.70 \times .1716 = 0.1201$

Stable Growth
g = 5%; Beta = 1.00
Country Premium = 3%
Cost of capital = 10.39%
Tax rate = 33.99%
ROC = 10.39%;
Reinvestment Rate = g/ROC
= $5\% / 10.39\% = 48.11\%$

Op. Assets 210,813
 + Cash: 11418
 + Crosshold 140576
 - Debt 109198
 = Equity 253,628
Value/Share Rs 614

Rs Cashflows

Terminal Value = $23493 / (.1039 - .05) = \text{Rs } 435,686$

Year	1	2	3	4	5	6	7	8	9	10
EBIT (1-t)	₹ 22,533	₹ 25,240	₹ 28,272	₹ 31,668	₹ 35,472	₹ 39,236	₹ 42,848	₹ 46,192	₹ 49,150	₹ 51,607
- Reinvestment	₹ 15,773	₹ 17,668	₹ 19,790	₹ 22,168	₹ 24,830	₹ 25,242	₹ 25,138	₹ 24,482	₹ 23,264	₹ 21,503
FCFF	₹ 6,760	₹ 7,572	₹ 8,482	₹ 9,500	₹ 10,642	₹ 13,994	₹ 17,711	₹ 21,710	₹ 25,886	₹ 30,104

45278
21785
23493

Discount at Cost of Capital (WACC) = $14.00\% (.747) + 8.09\% (0.253) = 12.50\%$

Growth declines to 5%
and cost of capital moves
to stable period level.

On April 1, 2010
Tata Motors price = Rs 781

Cost of Equity
14.00%

Cost of Debt
 $(5\% + 4.25\% + 3\%) (1 - .3399)$
= 8.09%

Weights
E = 74.7% D = 25.3%

Riskfree Rate:
Rs Riskfree Rate = 5%

$+$ **Beta** 1.20 \times **Mature market premium** 4.5% $+$ **Lambda** 0.80 \times **Country Equity Risk Premium** 4.50%

Unlevered Beta for Sectors: 0.98 Firm's D/E Ratio: 34%

Country Default Spread 3% \times Rel Equity Mkt Vol 1.50

Henkel: October 2016 (in Euros)

Cash flows from existing assets

	LTM	Last 10 years
Revenues	\$ 18,074	Growth rate = 4.20%
Operating margin	15.25%	Average = 12.80%
Sales/Invested Capital	1.33	Average = 1.52
Return on Invested Capital	15.26%	Average = 14.48%
Effective Tax Rate	24.20%	Average = 25.00%

The Payoff from growth

Revenues will grow 4.2% a year for next 5 years, tapering down to 0.1% growth in year 10

Operating margin (per-tax) will revert to ten-year average of 12.80%

Sales/Invested Capital will stay at ten-year average of 1.52

Stable Growth
 $g = 0.1\%$;
 Cost of capital = 7%
 $ROC = 7\%$;
 Reinvestment Rate = $g/ROC = .03\%/7\% = 0.42\%$

Terminal Value = $2,292 / (.07 - .0003) = 33,214$

Euro Cashflows

	Base year	1	2	3	4	5	6	7	8	9	10	Terminal Yr
Revenue growth rate		4.20%	4.20%	4.20%	4.20%	4.20%	3.38%	2.56%	1.74%	0.92%	0.10%	0.10%
Revenues	€ 18,074	€ 18,833	€ 19,624	€ 20,448	€ 21,307	€ 22,202	€ 22,952	€ 23,540	€ 23,950	€ 24,170	€ 24,194	€ 24,218
EBIT (Operating) margin	15.25%	15.00%	14.76%	14.51%	14.27%	14.02%	13.78%	13.53%	13.29%	13.04%	12.80%	12.80%
EBIT (Operating income)	€ 2,756	€ 2,826	€ 2,896	€ 2,968	€ 3,040	€ 3,114	€ 3,163	€ 3,186	€ 3,183	€ 3,153	€ 3,097	€ 3,100
Tax rate	25.00%	25.00%	25.00%	25.00%	25.00%	25.00%	25.00%	25.00%	25.00%	25.00%	25.00%	25.00%
EBIT(1-t)	€ 2,067	€ 2,119	€ 2,172	€ 2,226	€ 2,280	€ 2,335	€ 2,372	€ 2,390	€ 2,387	€ 2,365	€ 2,323	€ 2,325
- Reinvestment		€ 499	€ 520	€ 542	€ 565	€ 589	€ 494	€ 387	€ 269	€ 145	€ 16	€ 33
FCFF		€ 1,620	€ 1,652	€ 1,684	€ 1,715	€ 1,746	€ 1,878	€ 2,003	€ 2,118	€ 2,220	€ 2,307	€ 2,292

PV(Terminal value)	€ 16,316
PV (CF over next 10 years)	€ 12,741
Value of operating assets =	€ 29,057
- Debt	€ 2,048
- Minority interests	€ 138
+ Cash	€ 2,305
Value of equity	€ 29,176
Number of shares	399.83
Estimated value /share	€ 72.97

Discount at $\$$ Cost of Capital (WACC) = $7.78\% (.958) + 0.72\% (0.042) = 7.48\%$

The Risk in the Cash flows

On October 25, 2016, Henkel was trading at 118 Euros per share

Cost of Equity
7.78%

Cost of Debt
 $(0.03\% + .1\%)(1 - .2965) = 0.72\%$

Weights
E = 95.8% D = 4.2%

Riskfree Rate:
Euro Risk free rate = 0.03%

Beta = 1.01

Firm's D/E
Ratio: 4.4%

Business	Estimated Value	Weight	Unlevered Beta
Chemical (Specialty)	€ 16,276	35.61%	1.03
Household Products	€ 14,486	31.69%	0.96
Cosmetics/Toiletries	€ 14,949	32.70%	0.93
Henkel	€ 45,711		0.98

ERP = 7.71%

Region	Revenues	Weight	ERP
Africa	€ 600	3.34%	11.76%
Asia	€ 3,134	17.45%	7.49%
Central and South America	€ 1,110	6.18%	10.42%
Eastern Europe & Russia	€ 2,695	15.00%	9.65%
Middle East	€ 729	4.06%	7.11%
North America	€ 3,648	20.31%	6.00%
Western Europe	€ 6,045	33.66%	7.16%
Henkel	€ 17,961	100.00%	7.71%



DCF INPUTS

“Garbage in, garbage out”

I. Measure earnings right..

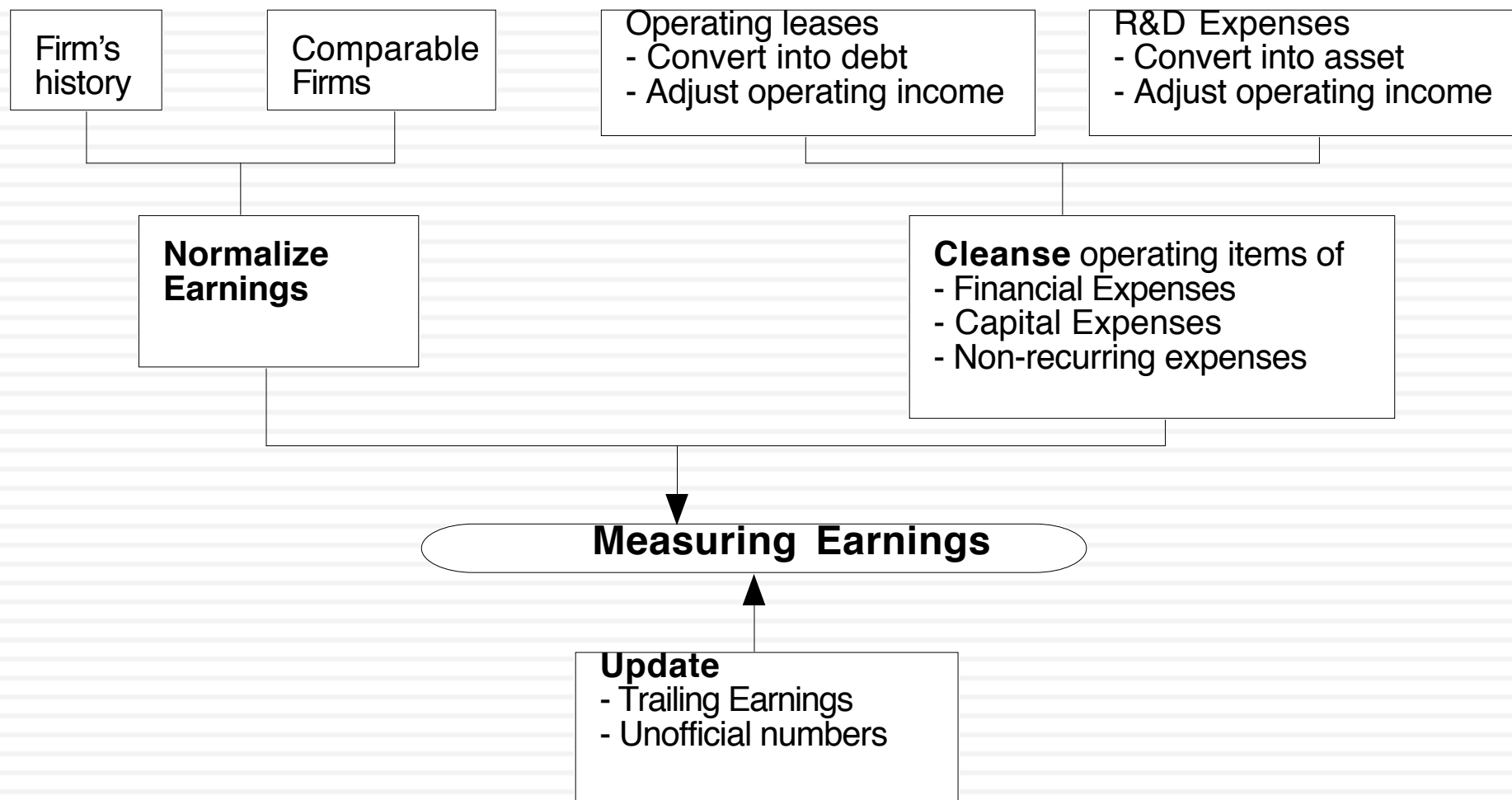

Operating Leases at Amgen in 2007

- Amgen has lease commitments and its cost of debt (based on its A rating) is 5.63%.

Year	Commitment	Present Value
1	\$96.00	\$90.88
2	\$95.00	\$85.14
3	\$102.00	\$86.54
4	\$98.00	\$78.72
5	\$87.00	\$66.16
6-12	\$107.43	\$462.10 (\$752 million prorated)

- Debt Value of leases = \$869.55
- Debt outstanding at Amgen = \$7,402 + \$ 870 = \$8,272 million
- Adjusted Operating Income = Stated OI + Lease expense this year – Depreciation
= 5,071 m + 69 m - 870/12 = \$5,068 million (12 year life for assets)
- Approximate Operating income= stated OI + PV of Lease commitment * Pre-tax cost of debt
= \$5,071 m + 870 m (.0563) = \$ 5,120 million

Capitalizing R&D Expenses: Amgen

- R & D was assumed to have a 10-year life.

Year	R&D Expense	Unamortized portion	Amortization this year	
Current	3366.00	1.00	3366.00	
-1	2314.00	0.90	2082.60	\$231.40
-2	2028.00	0.80	1622.40	\$202.80
-3	1655.00	0.70	1158.50	\$165.50
-4	1117.00	0.60	670.20	\$111.70
-5	865.00	0.50	432.50	\$86.50
-6	845.00	0.40	338.00	\$84.50
-7	823.00	0.30	246.90	\$82.30
-8	663.00	0.20	132.60	\$66.30
-9	631.00	0.10	63.10	\$63.10
-10	558.00	0.00		\$55.80
Value of Research Asset =			\$10,112.80	\$1,149.90

- Adjusted Operating Income = \$5,120 + 3,366 - 1,150 = \$7,336 million

Henkel's Operating History

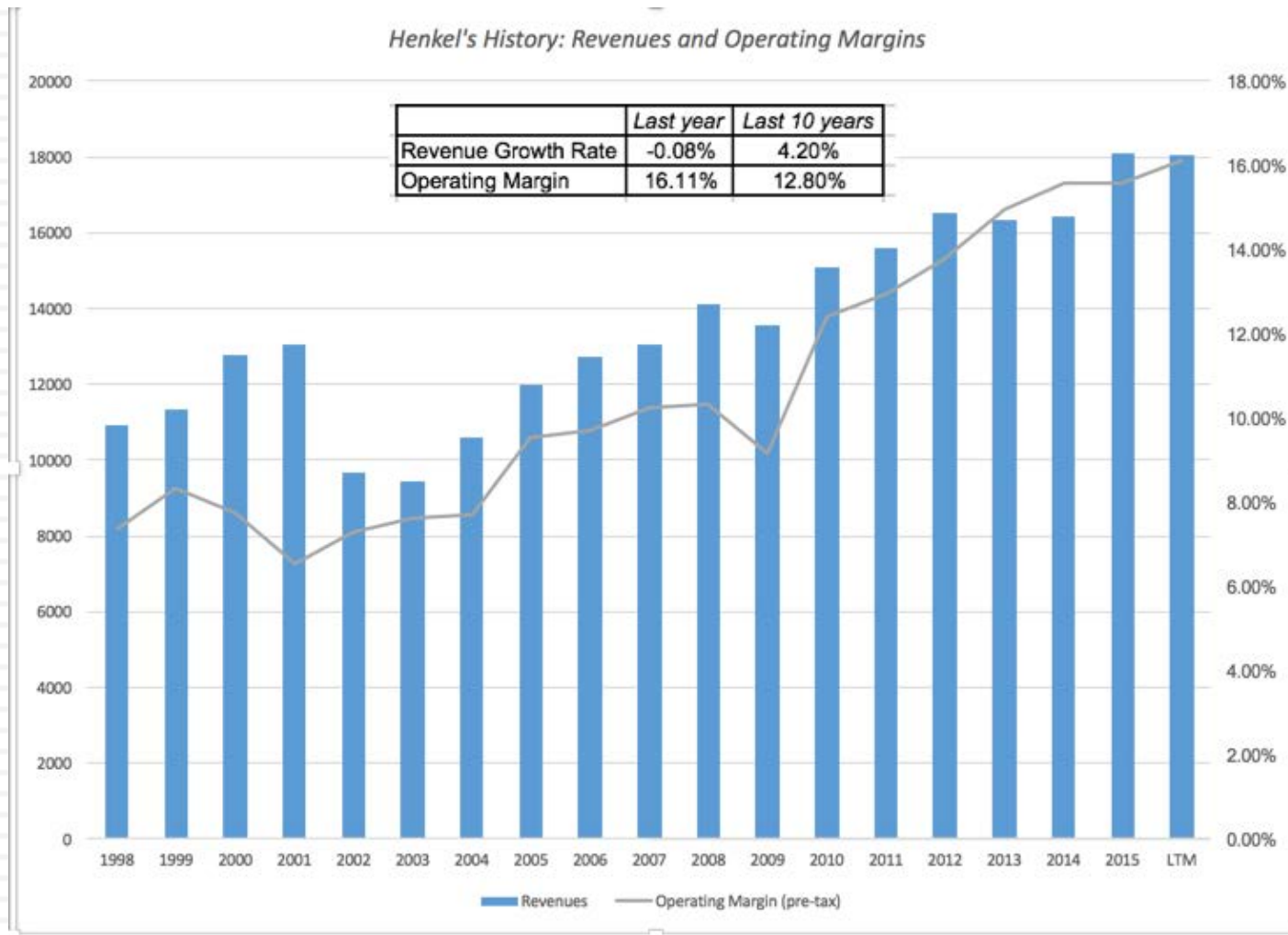

II. Get the big picture (not the accounting one) when it comes to cap ex and working capital

- Capital expenditures should include
 - ▣ Research and development expenses, once they have been re-categorized as capital expenses.
 - ▣ Acquisitions of other firms, whether paid for with cash or stock.
- Working capital should be defined not as the difference between current assets and current liabilities but as the difference between non-cash current assets and non-debt current liabilities.
- On both items, start with what the company did in the most recent year but do look at the company's history and at industry averages.

Amgen's Net Capital Expenditures

- The accounting net cap ex at Amgen is small:
 - Accounting Capital Expenditures = \$1,218 million
 - - Accounting Depreciation = \$ 963 million
 - Accounting Net Cap Ex = \$ 255 million
- We define capital expenditures broadly to include R&D and acquisitions:
 - Accounting Net Cap Ex = \$ 255 million
 - Net R&D Cap Ex = (3366-1150) = \$2,216 million
 - Acquisitions in 2006 = \$3,975 million
 - Total Net Capital Expenditures = \$ 6,443 million
- Acquisitions have been a volatile item. Amgen was quiet on the acquisition front in 2004 and 2005 and had a significant acquisition in 2003.

III. The government bond rate is not always the risk free rate

- When valuing Amgen in US dollars, the US\$ ten-year bond rate of 4.78% was used as the risk free rate. We assumed that the US treasury was default free.
- When valuing Tata Motors in Indian rupees in 2010, the Indian government bond rate of 8% was not default free. Using the Indian government's local currency rating of Ba2 yielded a default spread of 3% for India and a riskfree rate of 5% in Indian rupees.

Risk free rate in Indian Rupees = 8% - 3% = 5%

- To value Henkel in Euros, you need a risk free rate in Euros. Finding a ten-year government bond denominated in Euros is not the problem.. But choosing which one to use might be.

Euro Risk Free Rate?

Euro Government Bond Rates: October 2016

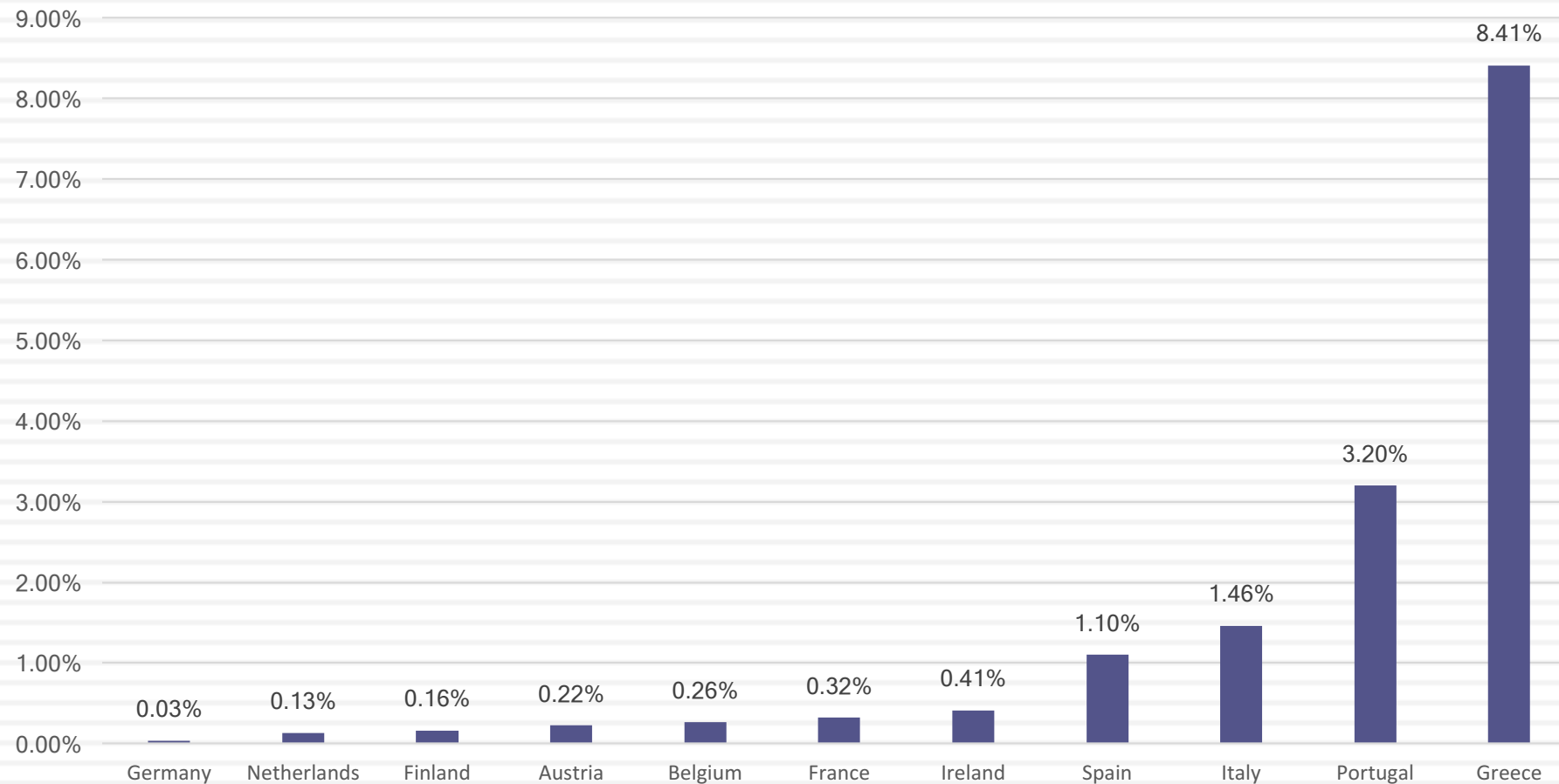

Risk free rates will vary across currencies!

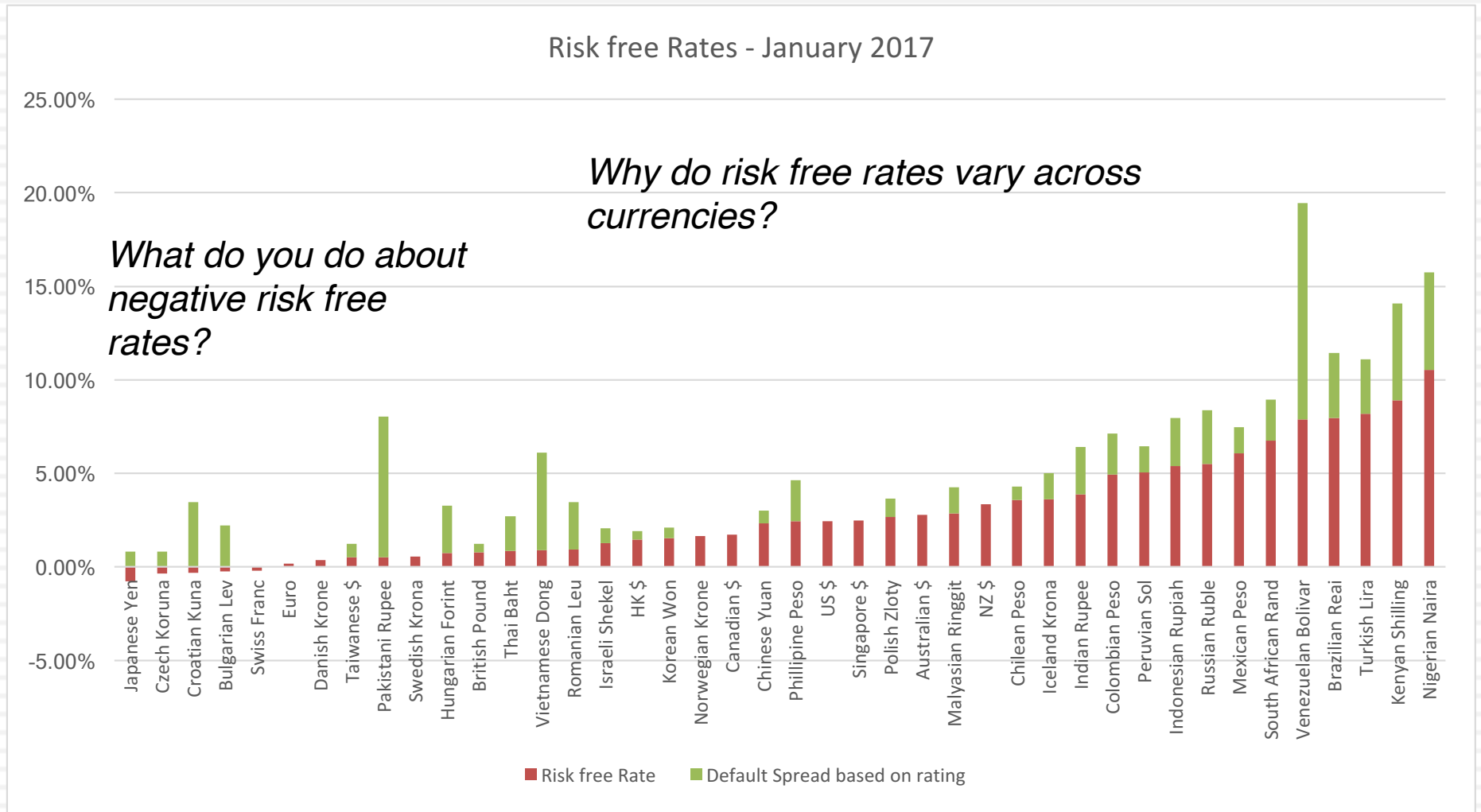

But valuations should not! Valuing Tata Motors

	In Indian Rupees	In US \$
Risk free Rate	5.00%	2.00%
Expected inflation rate	4.00%	1.00%
Cost of capital		
- High Growth	12.50%	9.25%
- Stable Growth	10.39%	7.21%
Expected growth rate		
- High Growth	12.01%	8.78%
- Stable Growth	5.00%	2.00%
Return on Capital		
- High Growth	17.16%	13.78%
- Stable Growth	10.39%	7.21%
Value per share	Rs 614	\$12.79/share (roughly Rs 614 at current exchange rate)

IV. Betas do not come from regressions... and are noisy...

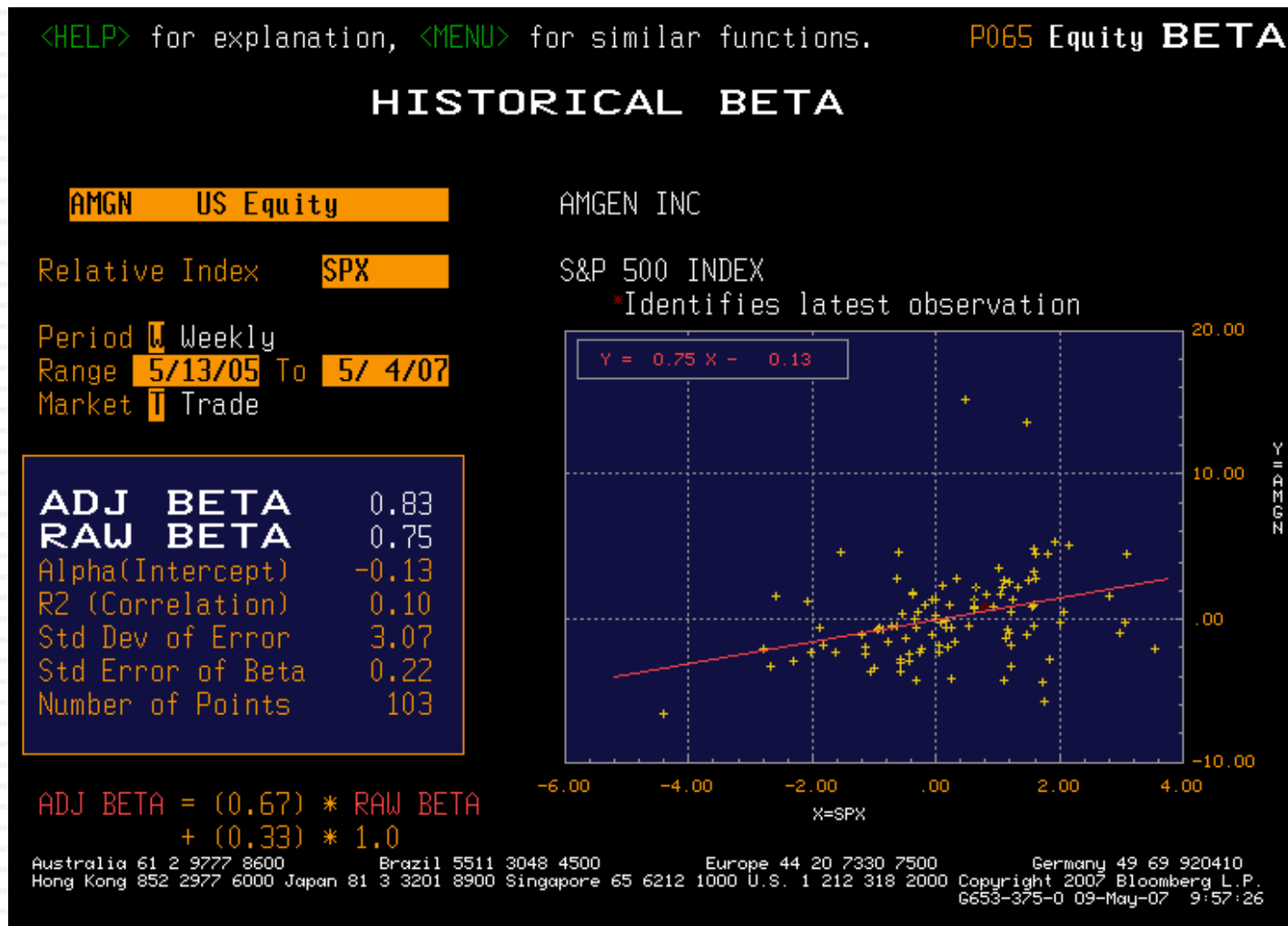

Look better for some companies, but not if run against narrow indices

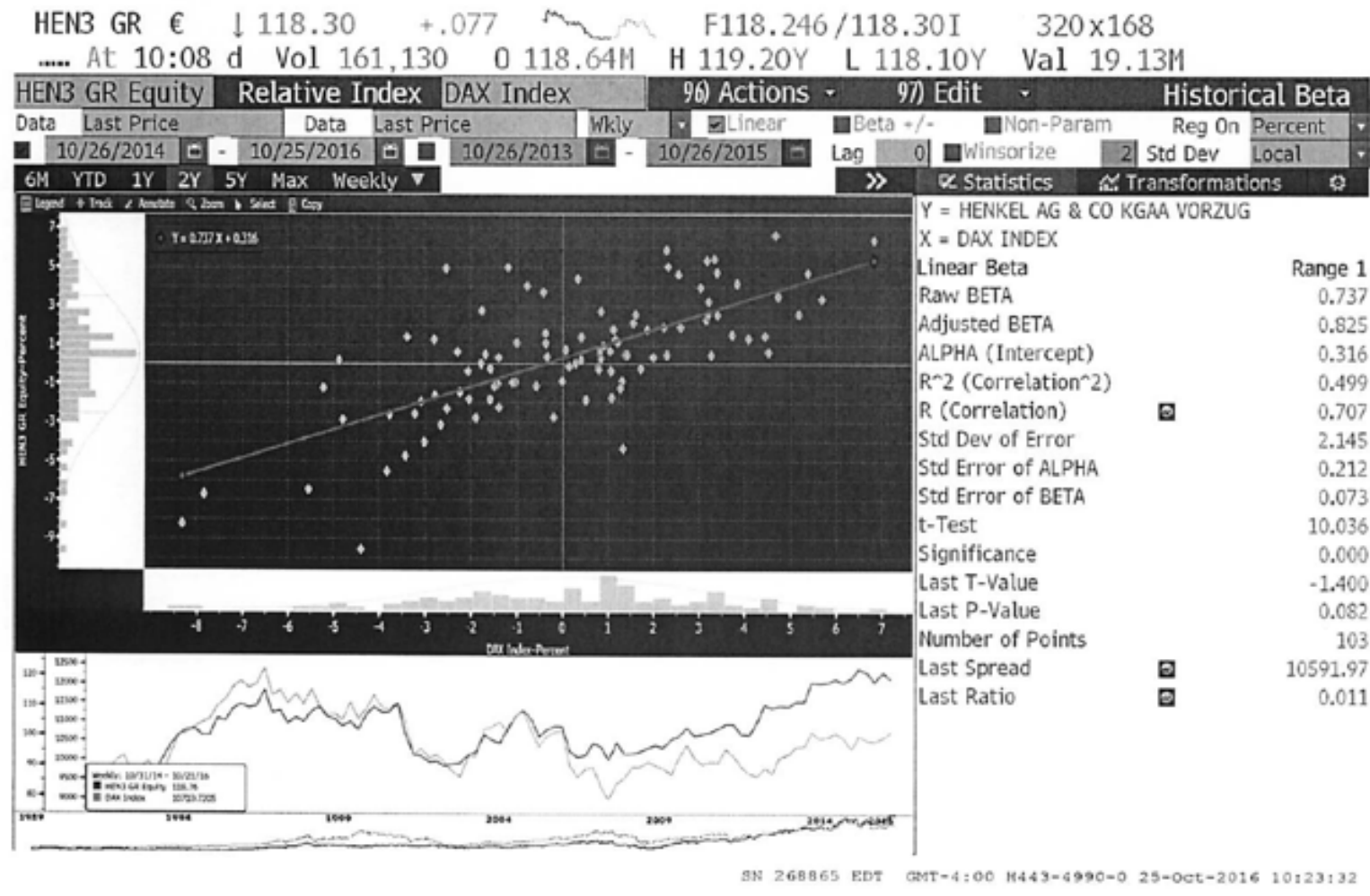

Determinants of Betas

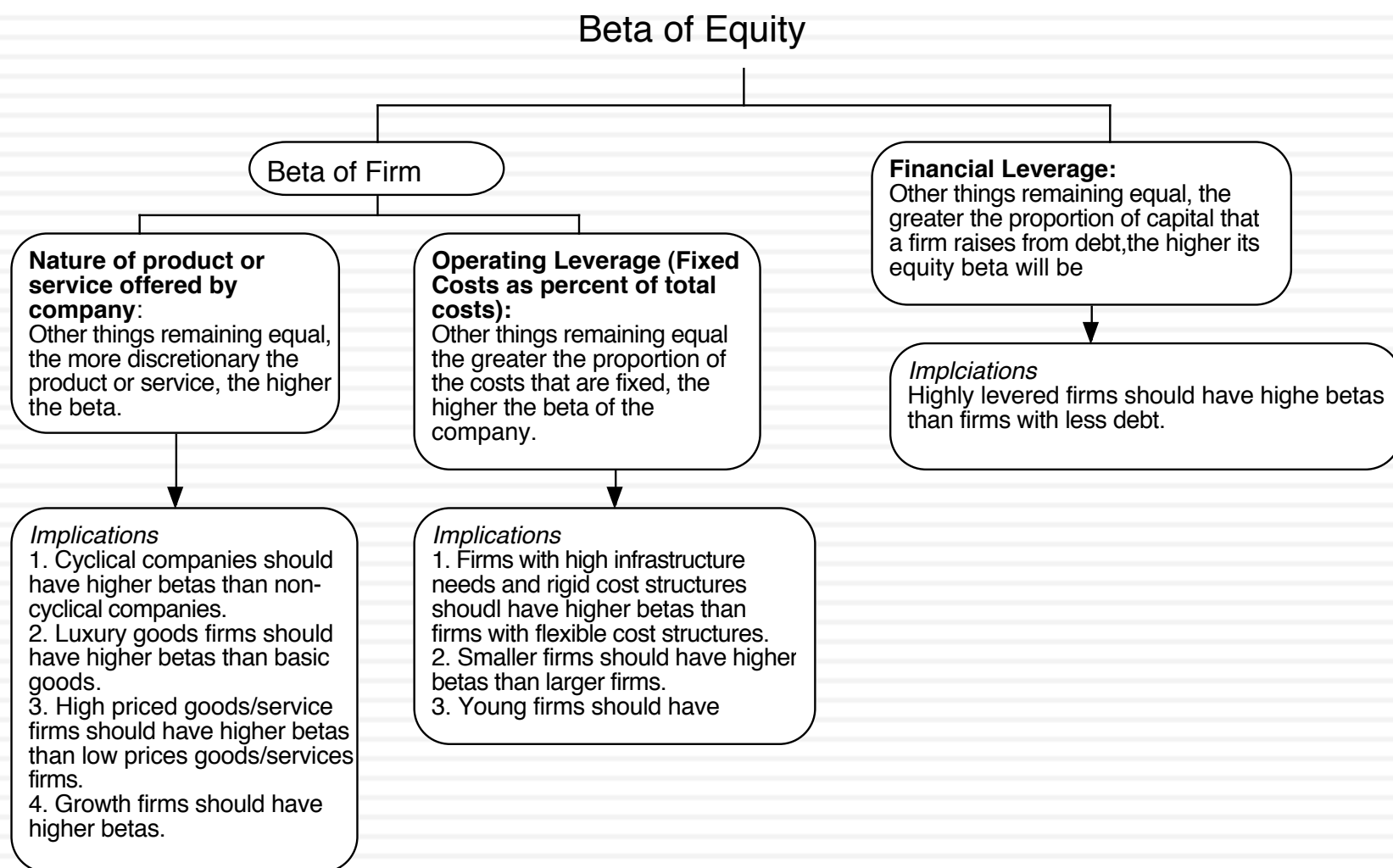

Bottom-up Betas

Step 1: Find the business or businesses that your firm operates in.

Step 2: Find publicly traded firms in each of these businesses and obtain their regression betas. Compute the simple average across these regression betas to arrive at an average beta for these publicly traded firms. Unlever this average beta using the average debt to equity ratio across the publicly traded firms in the sample.
Unlevered beta for business = $\text{Average beta across publicly traded firms} / (1 + (1-t) (\text{Average D/E ratio across firms}))$

Step 3: Estimate how much value your firm derives from each of the different businesses it is in.

Step 4: Compute a weighted average of the unlevered betas of the different businesses (from step 2) using the weights from step 3.
Bottom-up Unlevered beta for your firm = $\text{Weighted average of the unlevered betas of the individual business}$

Step 5: Compute a levered beta (equity beta) for your firm, using the market debt to equity ratio for your firm.
Levered bottom-up beta = $\text{Unlevered beta} (1 + (1-t) (\text{Debt/Equity}))$

Possible Refinements

If you can, adjust this beta for differences between your firm and the comparable firms on operating leverage and product characteristics.

While revenues or operating income are often used as weights, it is better to try to estimate the value of each business.

If you expect the business mix of your firm to change over time, you can change the weights on a year-to-year basis.

If you expect your debt to equity ratio to change over time, the levered beta will change over time.

Three examples...

□ Amgen

- The unlevered beta for pharmaceutical firms is 1.59. Using Amgen's debt to equity ratio of 11%, the bottom up beta for Amgen is

- Bottom-up Beta = $1.59 (1 + (1-.35)(.11)) = 1.73$

□ Tata Motors

- The unlevered beta for automobile firms is 0.98. Using Tata Motor's debt to equity ratio of 33.87%, the bottom up beta for Tata Motors is

- Bottom-up Beta = $0.98 (1 + (1-.3399)(.3387)) = 1.20$

□ Henkel

<i>Business</i>	<i>Estimated Value</i>	<i>Weight</i>	<i>Unlevered Beta</i>
Chemical (Specialty)	€ 16,276	35.61%	1.03
Household Products	€ 14,486	31.69%	0.96
Cosmetics/Toiletries	€ 14,949	32.70%	0.93
Henkel	€ 45,711		0.98

$$\text{Levered Beta} = 0.98 (1 + (1-.2965)(.044)) = 1.01$$

V. And the past is not always a good indicator of the future.

	<i>Arithmetic Average</i>		<i>Geometric Average</i>	
	Stocks - T. Bills	Stocks - T. Bonds	Stocks - T. Bills	Stocks - T. Bonds
1928-2015	7.92%	6.18%	6.05%	4.54%
Std Error	<i>2.15%</i>	<i>2.29%</i>		
1966-2015	6.05%	3.89%	4.69%	2.90%
Std Error	<i>2.42%</i>	<i>2.74%</i>		
2006-2015	7.87%	3.88%	6.11%	2.53%
Std Error	<i>6.06%</i>	<i>8.66%</i>		

- If you are going to use a historical risk premium, make it
 - ▣ Long term (because of the standard error)
 - ▣ Consistent with your risk free rate
 - ▣ A “compounded” average
- No matter which estimate you use, recognize that it is backward looking, is noisy and may reflect selection bias.

But in the future..

34

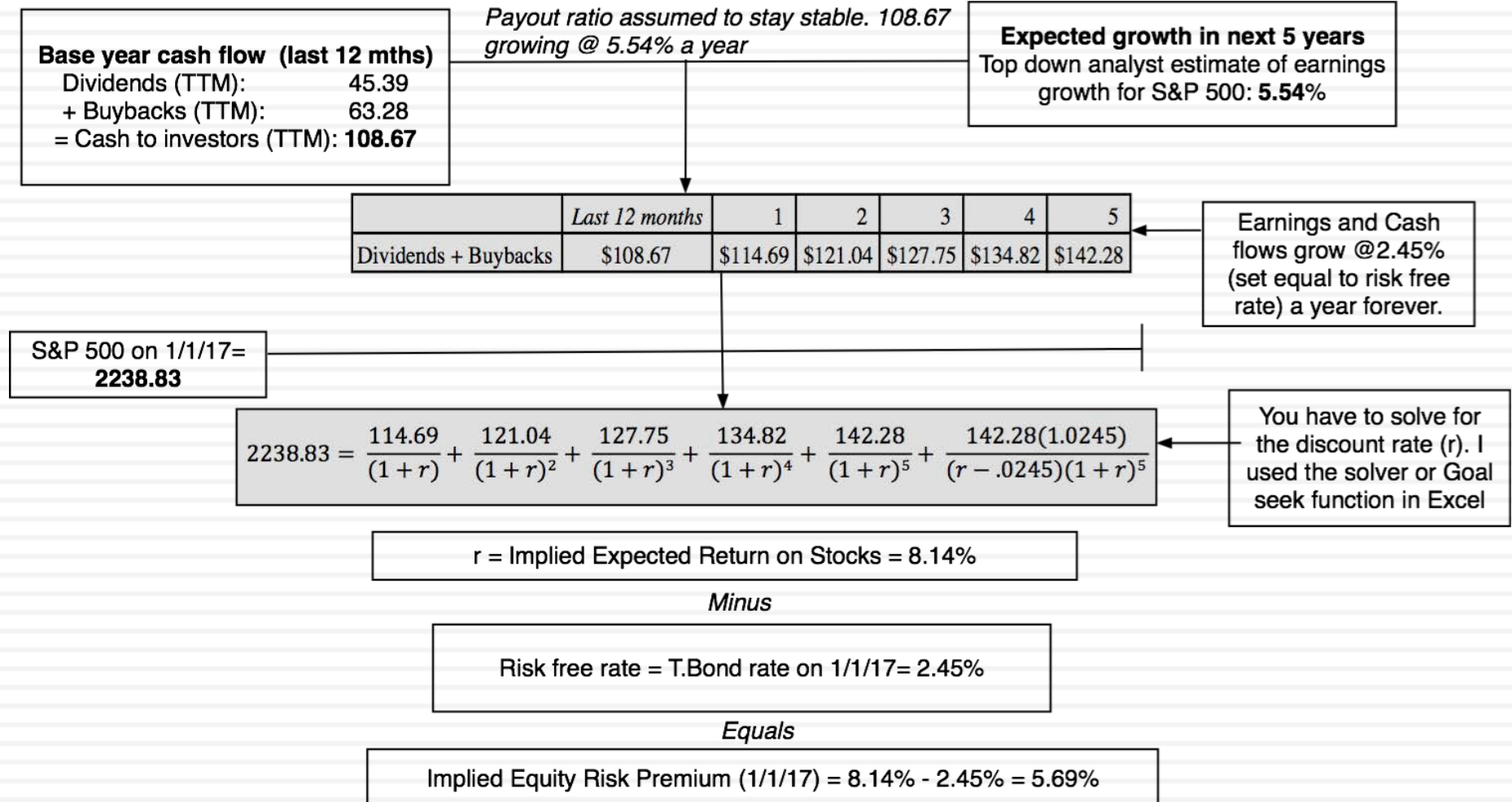

Implied Premiums in the US: 1960-2016

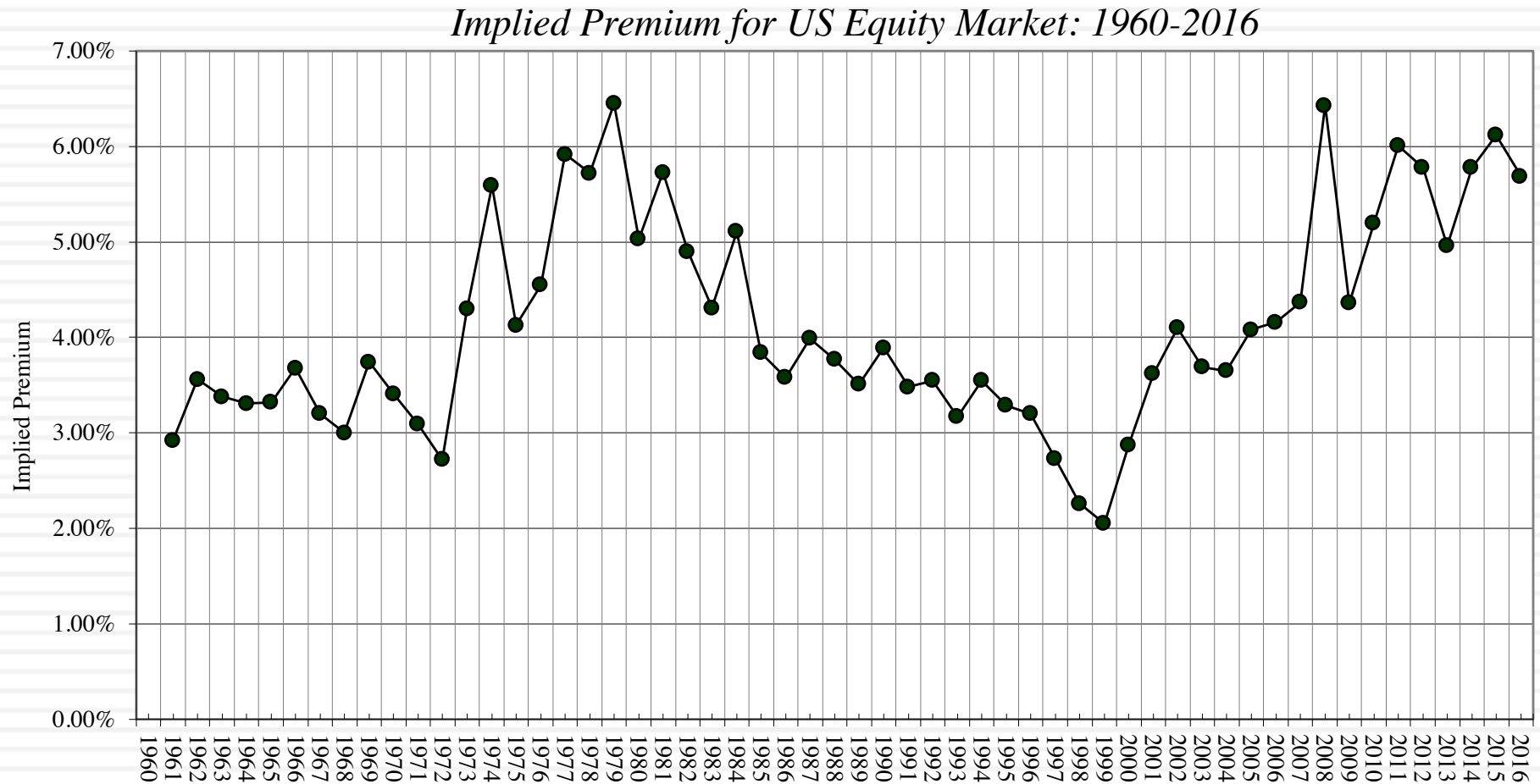

The Anatomy of a Crisis: Implied ERP from September 12, 2008 to January 1, 2009

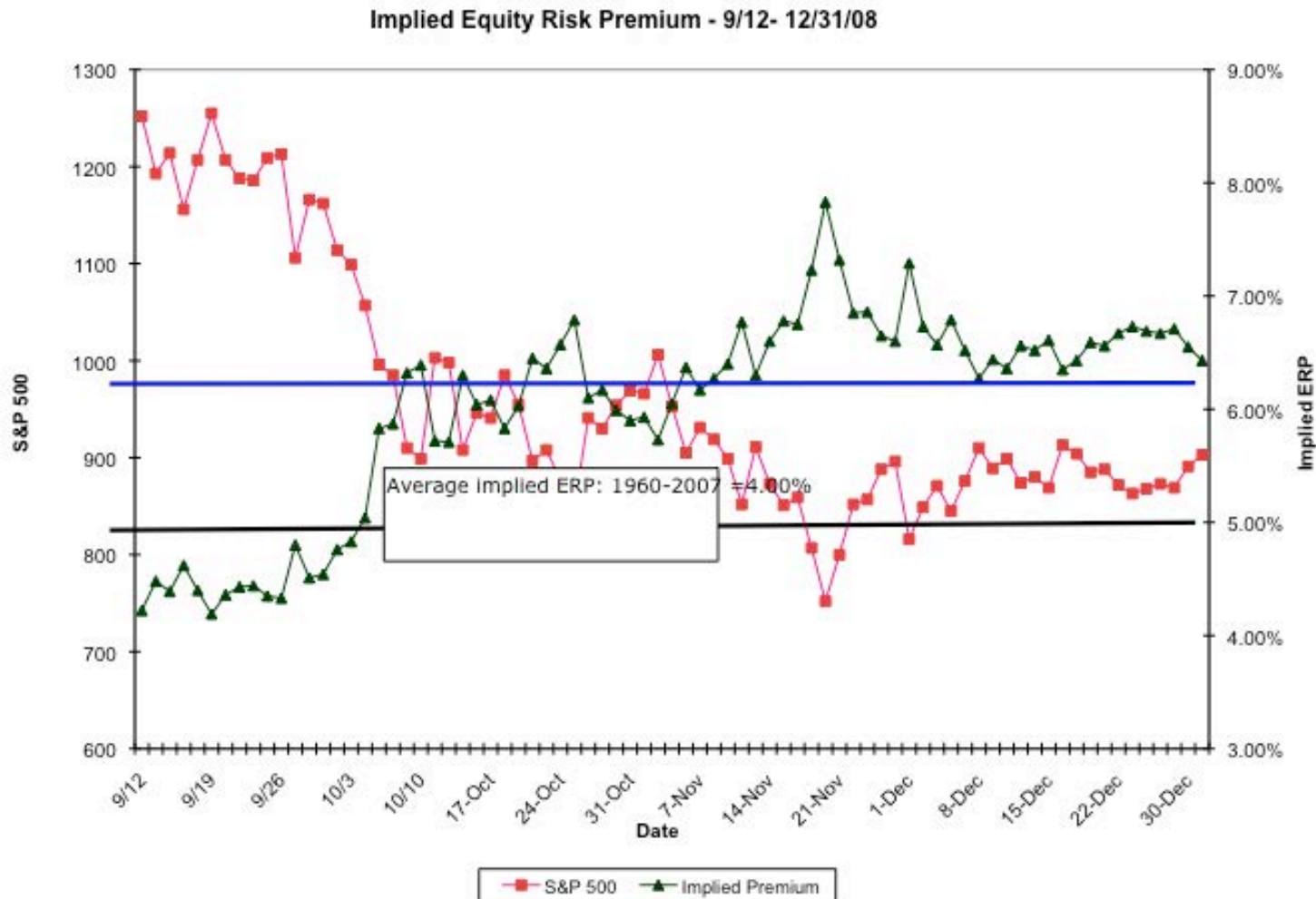

Implied Premium for India using the Sensex: April 2010

- Level of the Index = 17559
- FCFE on the Index = 3.5% (Estimated FCFE for companies in index as % of market value of equity)
- Other parameters
 - Riskfree Rate = 5% (Rupee)
 - Expected Growth (in Rupee)
 - Next 5 years = 20% (Used expected growth rate in Earnings)
 - After year 5 = 5%
- Solving for the expected return:
 - Expected return on Equity = 11.72%
 - Implied Equity premium for India = $11.72\% - 5\% = 6.72\%$

Emerging versus Developed Markets: Implied Equity Risk Premiums

$$PBV = \frac{(\text{Return on equity} - \text{Expected growth rate})}{(\text{Cost of equity} - \text{Expected growth rate})}$$

$$\text{Cost of Equity} = \frac{(\text{ROE} - \text{Expected growth rate})}{PBV} + \text{Expected growth rate}$$

Start of year	PBV Developed	PBV Emerging	ROE Developed	ROE Emerging	US T.Bond rate	Growth Rate Developed	Growth Rate Emerging	Cost of Equity (Developed)	Cost of Equity (Emerging)	Differential ERP
2004	2.00	1.19	10.81%	11.65%	4.25%	3.75%	5.25%	7.28%	10.63%	3.35%
2005	2.09	1.27	11.12%	11.93%	4.22%	3.72%	5.22%	7.26%	10.50%	3.24%
2006	2.03	1.44	11.32%	12.18%	4.39%	3.89%	5.39%	7.55%	10.11%	2.56%
2007	1.67	1.67	10.87%	12.88%	4.70%	4.20%	5.70%	8.19%	10.00%	1.81%
2008	0.87	0.83	9.42%	11.12%	4.02%	3.52%	5.02%	10.30%	12.37%	2.07%
2009	1.20	1.34	8.48%	11.02%	2.21%	1.71%	3.21%	7.35%	9.04%	1.69%
2010	1.39	1.43	9.14%	11.22%	3.84%	3.34%	4.84%	7.51%	9.30%	1.79%
2011	1.12	1.08	9.21%	10.04%	3.29%	2.79%	4.29%	8.52%	9.61%	1.09%
2012	1.17	1.18	9.10%	9.33%	1.88%	1.38%	2.88%	7.98%	8.35%	0.37%
2013	1.56	1.63	8.67%	10.48%	1.76%	1.26%	2.76%	6.02%	7.50%	1.48%
2014	1.95	1.50	9.27%	9.64%	3.04%	2.54%	4.04%	6.00%	7.77%	1.77%
2015	1.88	1.56	9.69%	9.75%	2.17%	1.67%	3.17%	5.94%	7.39%	1.45%
2016	1.89	1.59	9.24%	10.16%	2.27%	1.77%	3.27%	5.72%	7.60%	1.88%

VI. The Downside of Globalization: Dealing with Country Risk

- The Default Spread: Most practitioners estimate the equity risk premium for riskier markets by starting with a base premium for a mature market and adding the default spread for the government in the risky market.

ERP for country = ERP for Mature Market + Default spread for country

ERP for Indonesia = ERP for US + Default Spread for Indonesia
= 6% + 2.44% = 8.44%

- The Melded Default Spread: Equities are riskier than bonds and scaling up the default spread for the higher risk in equities should yield a better estimate of the additional risk for a country:

ERP for country = ERP for Mature Market + Default spread for country * (Std Deviation of Equity_{Country} / Std Deviation of Govt Bond_{Country})

ERP for Indonesia = 6% + 2.44% (15.91%/13.27%) = 8.93%

(Std Deviation in Indonesian Equities = 15.91%; Indonesian Govt Bond = 13.27%)

A Template for Estimating the ERP

ERP Estimation Procedure

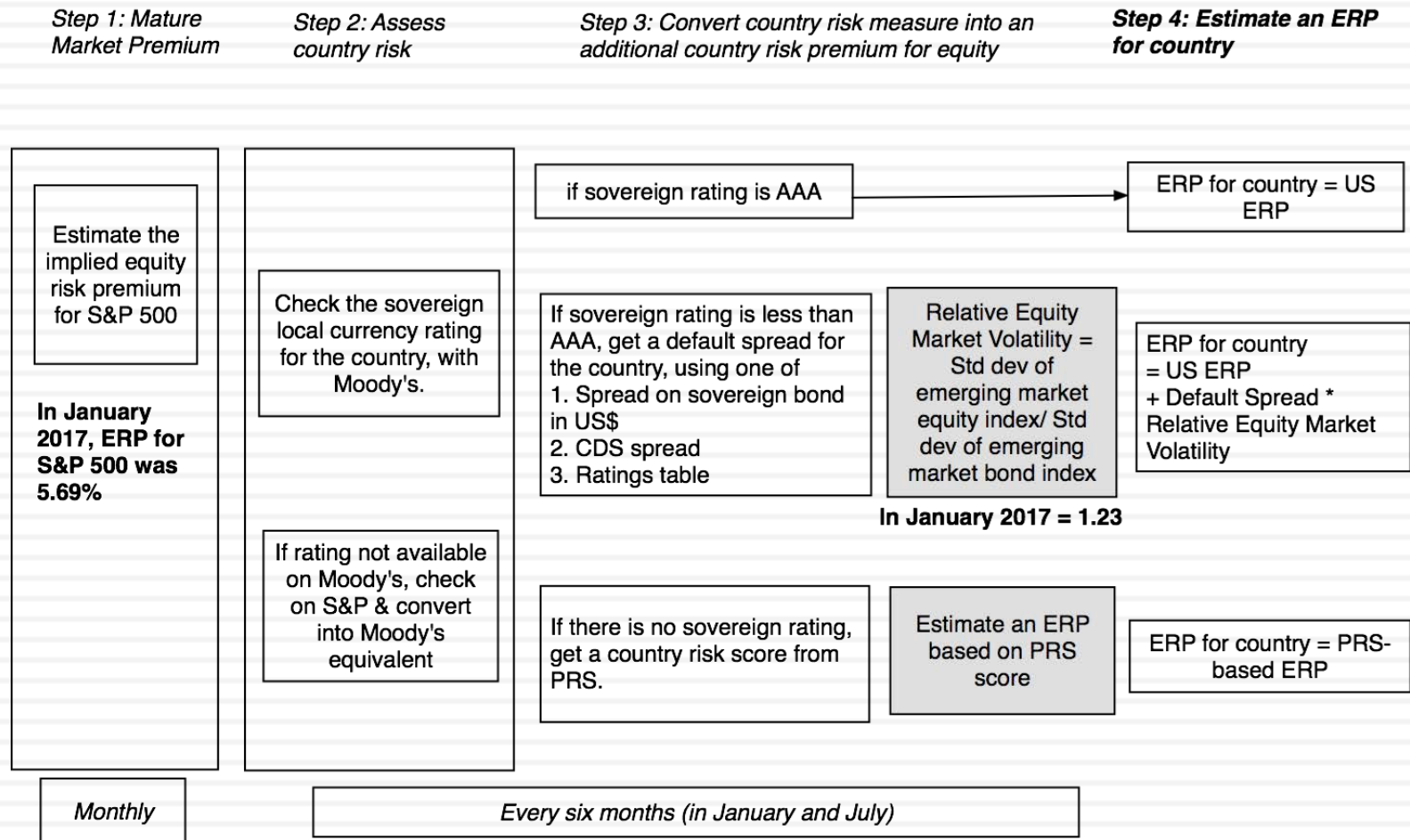

ERP : Jan 2017

Andorra	8.81%	3.12%	Jersey	6.26%	0.57%
Austria	6.26%	0.57%	Liechtenstein	5.69%	0.00%
Belgium	6.55%	0.86%	Luxembourg	5.69%	0.00%
Cyprus	12.09%	6.40%	Malta	7.40%	1.71%
Denmark	5.69%	0.00%	Netherlands	5.69%	0.00%
Finland	6.26%	0.57%	Norway	5.69%	0.00%
France	6.39%	0.70%	Portugal	9.24%	3.55%
Germany	5.69%	0.00%	Spain	8.40%	2.71%
Greece	19.89%	14.20%	Sweden	5.69%	0.00%
Guernsey	6.26%	0.57%	Switzerland	5.69%	0.00%
Iceland	7.40%	1.71%	Turkey	9.24%	3.55%
Ireland	7.40%	1.71%	UK	6.26%	0.57%
Isle of Man	6.26%	0.57%	W.Europe	6.81%	1.12%
Italy	8.40%	2.71%			

Albania	12.09%	6.40%
Armenia	12.09%	6.40%
Azerbaijan	9.24%	3.55%
Belarus	16.34%	10.65%
Bosnia and Her	14.93%	9.24%
Bulgaria	8.40%	2.71%
Croatia	9.96%	4.27%
Czech Republic	6.69%	1.00%
Estonia	6.69%	1.00%
Georgia	10.81%	5.12%
Hungary	8.81%	3.12%
Kazakhstan	8.81%	3.12%
Kyrgyzstan	13.51%	7.82%
Latvia	7.40%	1.71%
Lithuania	7.40%	1.71%
Macedonia	10.81%	5.12%
Moldova	14.93%	9.24%
Montenegro	12.09%	6.40%
Poland	6.90%	1.21%
Romania	8.81%	3.12%
Russia	9.24%	3.55%
Serbia	12.09%	6.40%
Slovakia	6.90%	1.21%
Slovenia	8.81%	3.12%
Ukraine	19.89%	14.20%
E.Europe	9.09%	3.40%

Country	ERP	CRP	Country	ERP	CRP
Algeria	13.72%	7.47%	Malawi	17.24%	10.99%
Brunei	9.75%	3.50%	Mali	13.90%	7.65%
Gambia	13.72%	7.47%	Myanmar	13.72%	7.47%
Guinea	20.00%	13.75%	Niger	17.24%	10.99%
Guinea-Bissau	12.48%	6.23%	Sierra Leone	16.61%	10.36%
Guyana	12.48%	6.23%	Somalia	20.00%	13.75%
Haiti	16.61%	10.36%	Sudan	20.00%	13.75%
Iran	11.22%	4.97%	Syria	20.00%	13.75%
Korea, D.P.R.	17.24%	10.99%	Tanzania	13.90%	7.65%
Liberia	17.24%	10.99%	Togo	13.72%	7.47%
Libya	20.00%	13.75%	Yemen, Republic	17.24%	10.99%
Madagascar	12.48%	6.23%	Zimbabwe	17.24%	10.99%

Canada	5.69%	0.00%
USA	5.69%	0.00%
North America	5.69%	0.00%

Caribbean	13.81%	8.12%
------------------	---------------	--------------

Argentina	14.93%	9.24%
Belize	18.48%	12.79%
Bolivia	10.81%	5.12%
Brazil	9.96%	4.27%
Chile	6.55%	0.86%
Colombia	8.40%	2.71%
Costa Rica	9.24%	3.55%
Ecuador	14.93%	9.24%
El Salvador	14.93%	9.24%
Guatemala	9.24%	3.55%
Honduras	13.51%	7.82%
Mexico	7.40%	1.71%
Nicaragua	13.51%	7.82%
Panama	8.40%	2.71%
Paraguay	9.24%	3.55%
Peru	7.40%	1.71%
Suriname	12.09%	6.40%
Uruguay	8.40%	2.71%
Venezuela	19.89%	14.20%
Latin America	10.11%	4.42%

Angola	12.09%	6.40%
Botswana	6.90%	1.21%
Burkina Faso	14.93%	9.24%
Cameroon	13.51%	7.82%
Cape Verde	13.51%	7.82%
Congo (DR)	14.93%	9.24%
Congo (Rep)	14.93%	9.24%
Côte d'Ivoire	10.81%	5.12%
Egypt	14.93%	9.24%
Ethiopia	12.09%	6.40%
Gabon	12.09%	6.40%
Ghana	14.93%	9.24%
Kenya	12.09%	6.40%
Morocco	9.24%	3.55%
Mozambique	19.89%	14.20%
Namibia	8.81%	3.12%
Nigeria	12.09%	6.40%
Rwanda	13.51%	7.82%
Senegal	12.09%	6.40%
South Africa	8.40%	2.71%
Tunisia	10.81%	5.12%
Uganda	13.51%	7.82%
Zambia	14.93%	9.24%
Africa	11.98%	6.29%

Bahrain	9.96%	4.27%
Iraq	14.94%	9.25%
Israel	6.69%	1.00%
Jordan	12.09%	6.40%
Kuwait	6.40%	0.71%
Lebanon	13.51%	7.82%
Oman	7.96%	2.27%
Qatar	6.40%	0.71%
Ras Al Khaimah	6.90%	1.21%
Saudi Arabia	6.69%	1.00%
Sharjah	7.40%	1.71%
United Arab Emirates	6.40%	0.71%
Middle East	7.50%	1.81%

Bangladesh	10.81%	5.12%
Cambodia	13.51%	7.82%
China	6.55%	0.86%
Fiji	12.09%	6.40%
Hong Kong	6.26%	0.57%
India	8.81%	3.12%
Indonesia	8.81%	3.12%
Japan	6.69%	1.00%
Korea	6.39%	0.70%
Macao	6.55%	0.86%
Malaysia	7.40%	1.71%
Mauritius	7.95%	2.26%
Mongolia	16.34%	10.65%
Pakistan	14.93%	9.24%
Papua New Guinea	13.51%	7.82%
Philippines	8.40%	2.71%
Singapore	5.69%	0.00%
Sri Lanka	12.09%	6.40%
Taiwan	6.55%	0.86%
Thailand	7.95%	2.26%
Vietnam	12.09%	6.40%
Asia	7.12%	1.43%

Australia	5.69%	0.00%
Cook Islands	12.09%	6.40%
New Zealand	5.69%	0.00%
Australia & NZ	5.70%	0.01%

Black #: Total ERP
 Red #: Country risk premium
 AVG: GDP weighted average

VII. And it is not just emerging market companies that are exposed to this risk..

- The “default” approach in valuation has been to assign country risk based upon your country of incorporation. Thus, if you are incorporated in a developed market, the assumption has been that you are not exposed to emerging market risks. If you are incorporated in an emerging market, you are saddled with the entire country risk.
- As companies globalize and look for revenues in foreign markets, this practice will under estimate the costs of equity of developed market companies with significant emerging market risk exposure and over estimate the costs of equity of emerging market companies with significant developed market risk exposure.

One way of dealing with this: Operation-based ERP for Henkel

<i>Region</i>	<i>Revenues in LTM</i>	<i>Weight</i>	<i>ERP</i>
Africa	€ 600	3.34%	11.76%
Asia	€ 3,134	17.45%	7.49%
Central and South America	€ 1,110	6.18%	10.42%
Eastern Europe & Russia	€ 2,695	15.00%	9.65%
Middle East	€ 729	4.06%	7.11%
North America	€ 3,648	20.31%	6.00%
Western Europe	€ 6,045	33.66%	7.16%
Henkel	€ 17,961	100.00%	7.71%

Natural Resource Twists? Royal Dutch

<i>Country</i>	<i>Oil & Gas Production</i>	<i>% of Total</i>	<i>ERP</i>
Denmark	17396	3.83%	6.20%
Italy	11179	2.46%	9.14%
Norway	14337	3.16%	6.20%
UK	20762	4.57%	6.81%
<i>Rest of Europe</i>	<i>874</i>	<i>0.19%</i>	<i>7.40%</i>
Brunei	823	0.18%	9.04%
Iraq	20009	4.40%	11.37%
Malaysia	22980	5.06%	8.05%
Oman	78404	17.26%	7.29%
Russia	22016	4.85%	10.06%
<i>Rest of Asia & ME</i>	<i>24480</i>	<i>5.39%</i>	<i>7.74%</i>
<i>Oceania</i>	<i>7858</i>	<i>1.73%</i>	<i>6.20%</i>
Gabon	12472	2.75%	11.76%
Nigeria	67832	14.93%	11.76%
Rest of Africa	6159	1.36%	12.17%
USA	104263	22.95%	6.20%
Canada	8599	1.89%	6.20%
Brazil	13307	2.93%	9.60%
<i>Rest of Latin America</i>	<i>576</i>	<i>0.13%</i>	<i>10.78%</i>
Royal Dutch Shell	454326	100.00%	8.26%

An alternate way: Estimating a company's exposure to country risk (Lambda)

- **Just as beta measures exposure to macro economic risk, lambda measures exposure just to country risk. Like beta, it is scaled around one.**
- The easiest and most accessible data is on revenues. Most companies break their revenues down by region. One simplistic solution would be to do the following:

$$\text{Lambda} = \% \text{ of revenues domestically}_{\text{firm}} / \% \text{ of revenues domestically}_{\text{average firm}}$$

- In 2008-09, Tata Motors got about 91.37% of its revenues in India and TCS got 7.62%. The average Indian firm gets about 80% of its revenues in India:
 - $\text{Lambda}_{\text{Tata Motors}} = 91\%/80\% = 1.14$
 - The danger of focusing just on revenues is that it misses other exposures to risk (production and operations).

	<i>Tata Motors</i>	<i>TCS</i>
% of production/operations in India	High	High
% of revenues in India	91.37% (in 2009) Estimated 70% (in 2010)	7.62%
Lambda	0.80	0.20
Flexibility in moving operations	Low. Significant physical assets.	High. Human capital is mobile.

VIII. Growth has to be earned (not endowed or estimated): Sustainable Growth

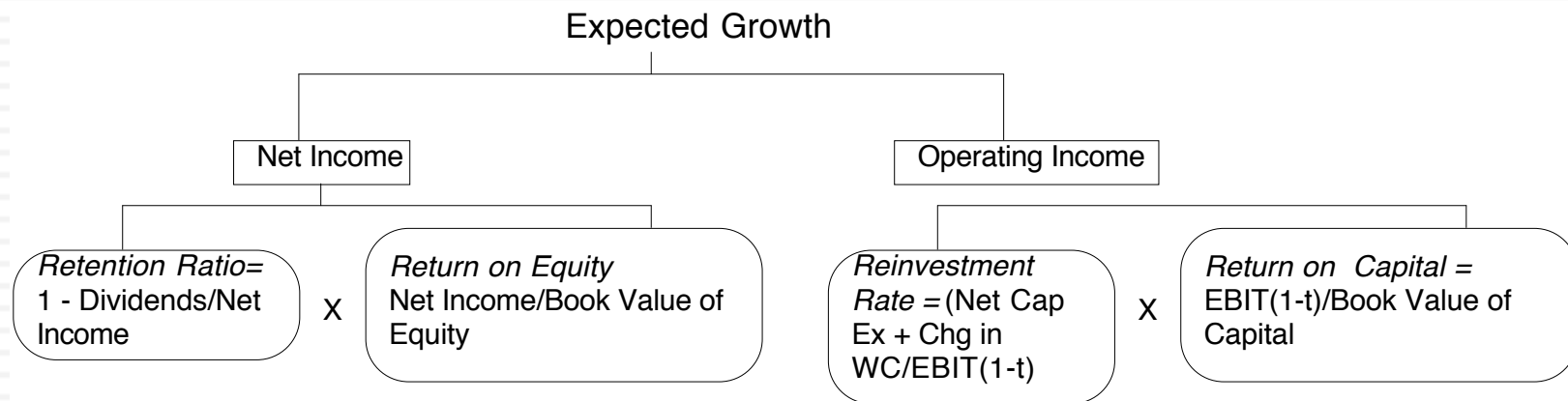

1. No free growth: In the long term, to grow, you have to reinvest.
2. Growth Quality: For a given reinvestment, the higher the return you generate on your reinvestment, the faster you can grow.
3. Scaling up is hard to do.

Measuring Returns: The Quandary

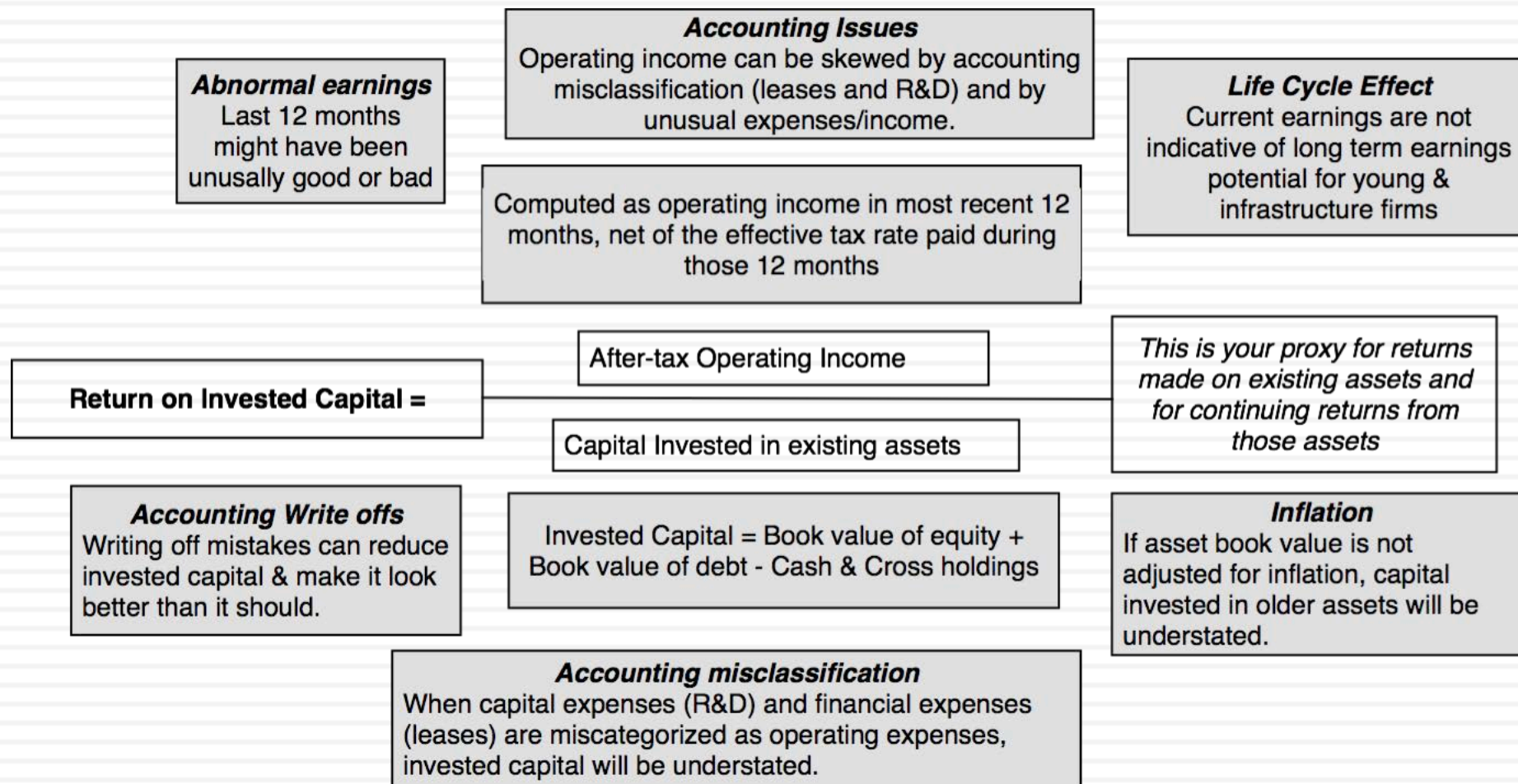

Operating income, Reinvestment & Return on Capital -

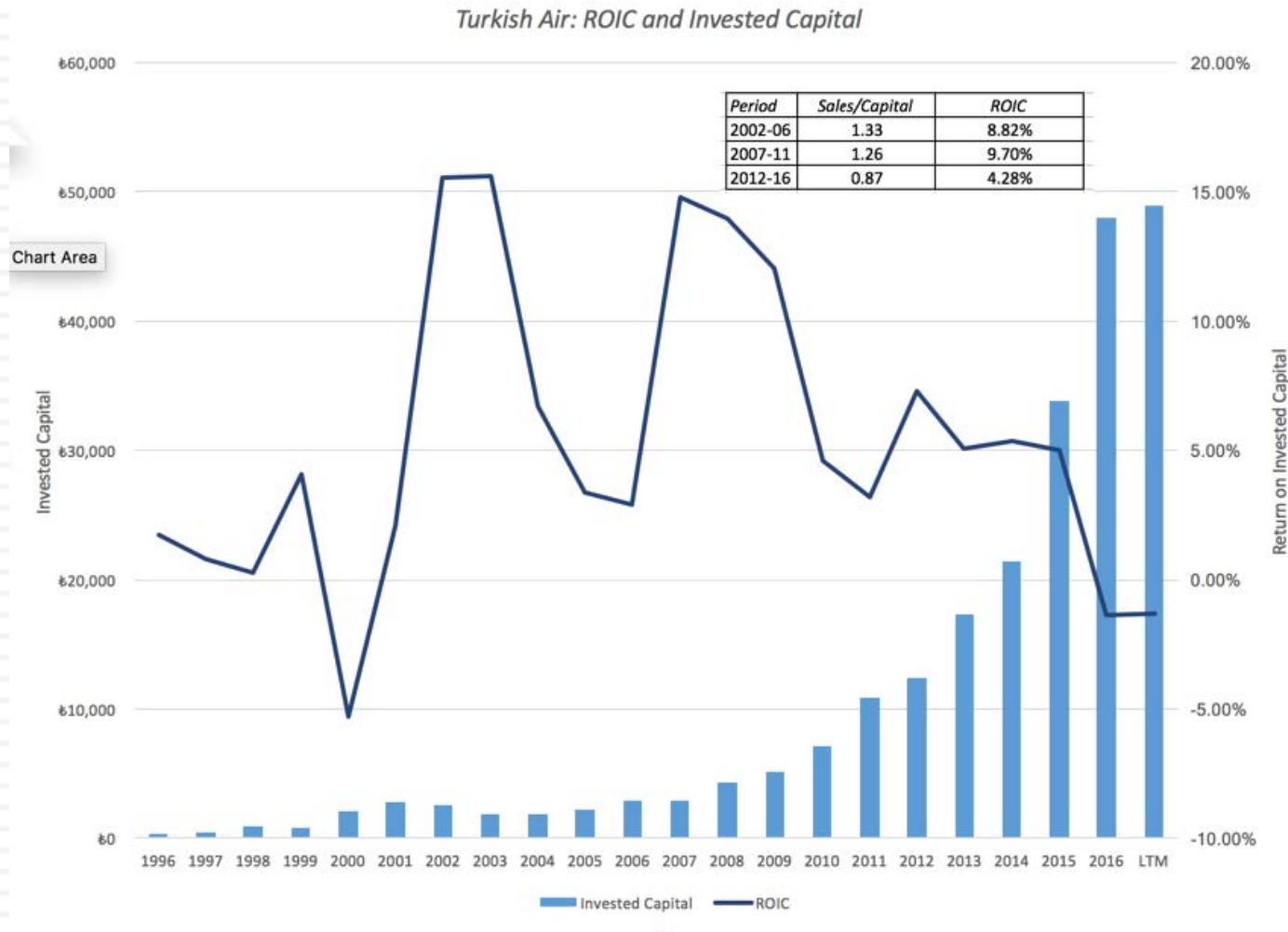

Earn at least your cost of capital! But companies seem to have trouble in practice

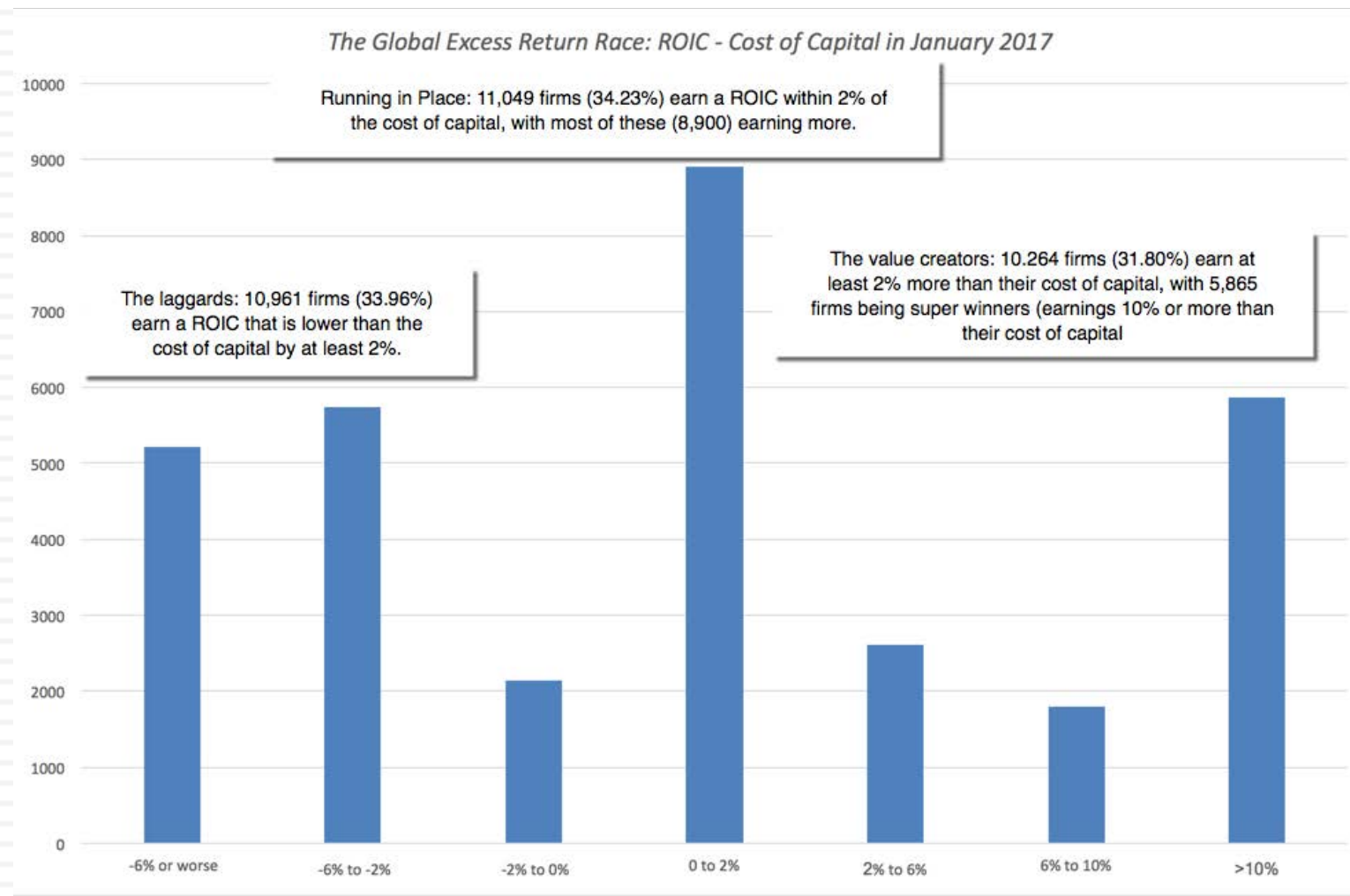

A Regional Breakdown

Sub Group	Number of firms	Cost of Capital	ROIC	ROIC - Cost of Capital	% of firms with ROIC>WACC
Africa and Middle East	1,742	9.38%	7.08%	-2.29%	36.02%
Australia & NZ	1,527	7.67%	4.98%	-2.69%	28.35%
Canada	2,601	7.89%	3.14%	-4.76%	15.88%
China	4,793	8.05%	5.74%	-2.31%	38.84%
EU & Environs	4,812	8.07%	8.88%	0.81%	42.92%
Eastern Europe & Russia	491	9.90%	7.70%	-2.19%	33.98%
India	2,966	9.55%	13.56%	4.01%	39.84%
Japan	3,487	7.83%	7.37%	-0.46%	51.73%
Latin America	748	9.28%	7.90%	-1.38%	42.92%
Small Asia	7,500	9.06%	7.55%	-1.50%	35.18%
UK	1,193	8.04%	8.06%	0.02%	44.42%
United States	6,125	7.54%	10.23%	2.69%	42.40%

A More General Way to Estimate Growth: Top Down Growth

- All of the fundamental growth equations assume that the firm has a return on equity or return on capital it can sustain in the long term.
- When operating income is negative or margins are expected to change over time, we use a three step process to estimate growth:
 - ▣ Estimate growth rates in revenues over time
 - Determine the total market (given your business model) and estimate the market share that you think your company will earn.
 - Decrease the growth rate as the firm becomes larger
 - Keep track of absolute revenues to make sure that the growth is feasible
 - ▣ Estimate expected operating margins each year
 - Set a target margin that the firm will move towards
 - Adjust the current margin towards the target margin
 - ▣ Estimate the capital that needs to be invested to generate revenue growth and expected margins
 - Estimate a sales to capital ratio that you will use to generate reinvestment needs each year.

IX. All good things come to an end..And the terminal value is not an ATM...

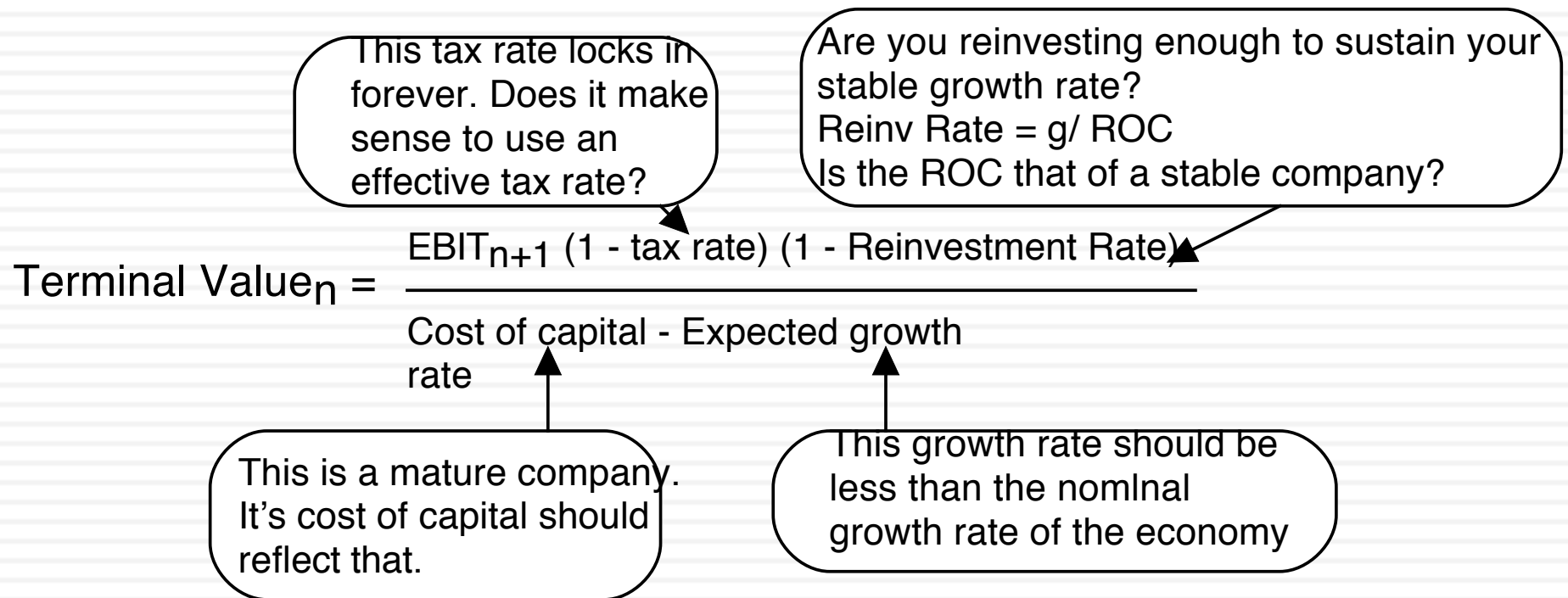

Terminal Value and Growth

Stable Growth Rate	Amgen	Tata Motors	Henkel
0%	\$150,652	₹ 435,686	€33,214
1%	\$154,479	₹ 435,686	€33,214
2%	\$160,194	₹ 435,686	
3%	\$167,784	₹ 435,686	
4%	\$179,099	₹ 435,686	
5%		₹ 435,686	
Risk free Rate	4.78%	5.00%	0.10%
Cost of capital	8.08%	10.39%	7.00%
Return on capital	10.00%	10.39%	7.00%

Just an aside: Don't blame the risk free rate

Henkel: Value per share versus Risk free Rate

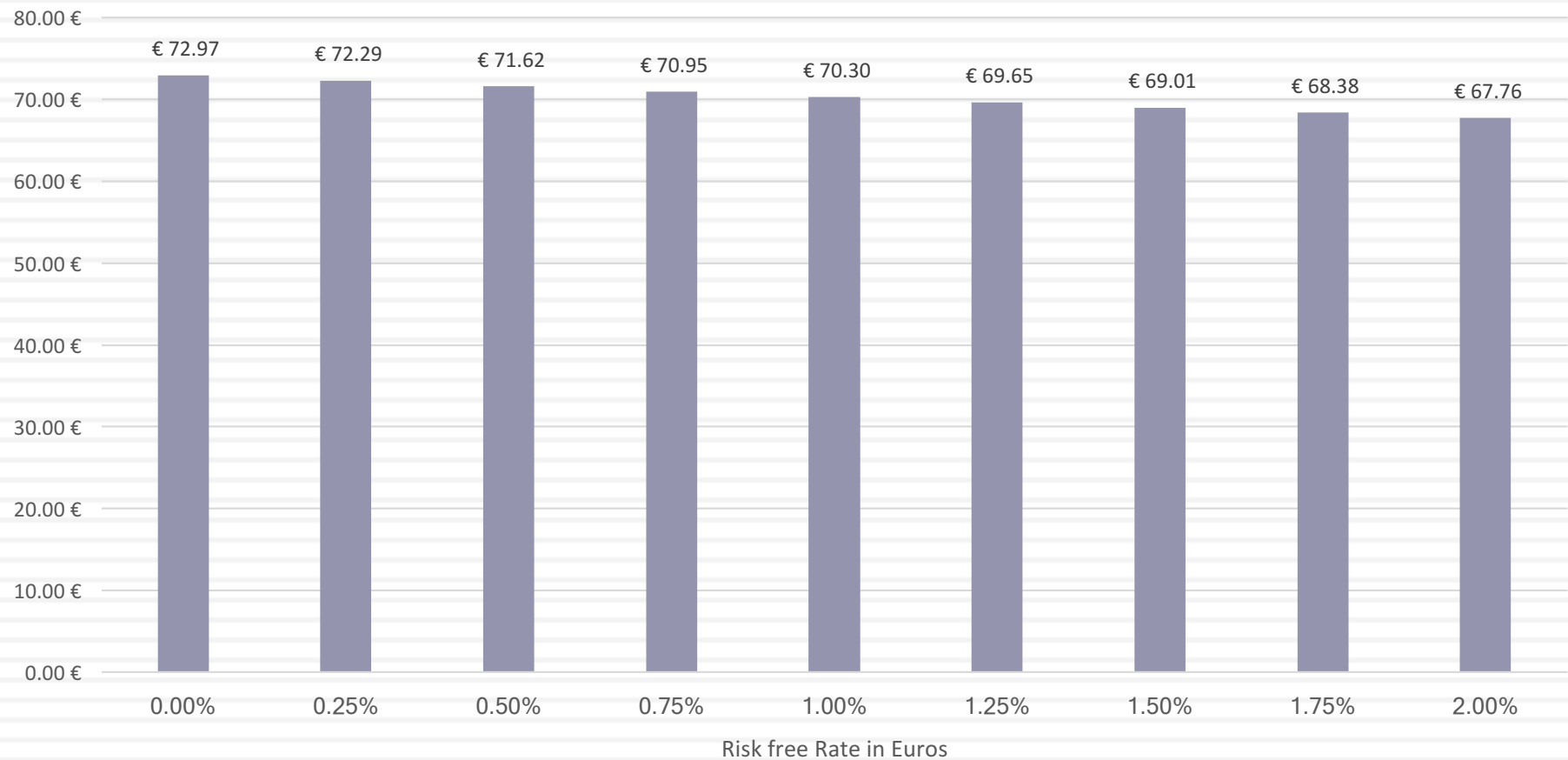



Aswath Damodaran

THE LOOSE ENDS IN VALUATION...

Aswath Damodaran

Getting from DCF to value per share: The Loose Ends

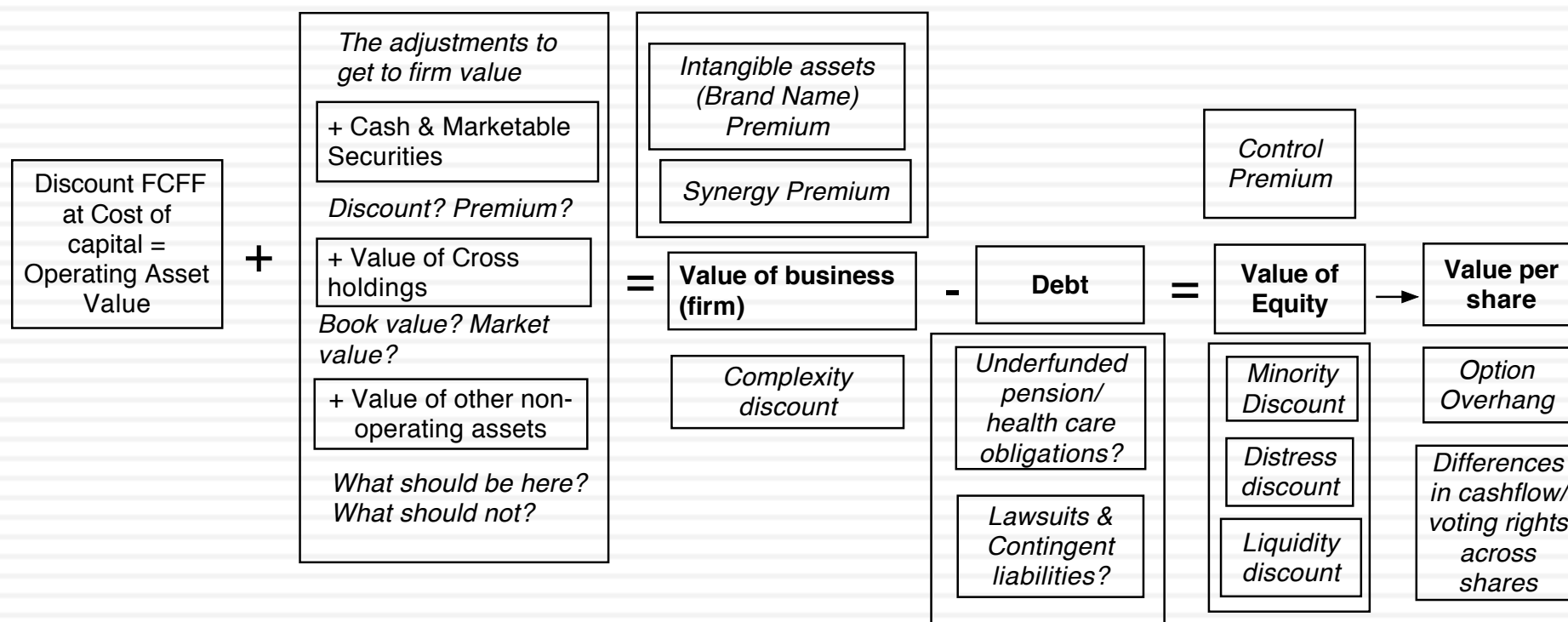

1. The Value of Cash

An Exercise in Cash Valuation

	<i>Company A</i>	<i>Company B</i>	<i>Company C</i>
Enterprise Value	\$ 1 billion	\$ 1 billion	\$ 1 billion
Cash	\$ 100 mil	\$ 100 mil	\$ 100 mil
Return on Capital	10%	5%	22%
Cost of Capital	10%	10%	12%
Trades in	US	US	Argentina

- In which of these companies is cash most likely to trade at face value, at a discount and at a premium?

Cash: Discount or Premium?

*Market Value of \$ 1 in cash:
Estimates obtained by regressing Enterprise Value against Cash Balances*

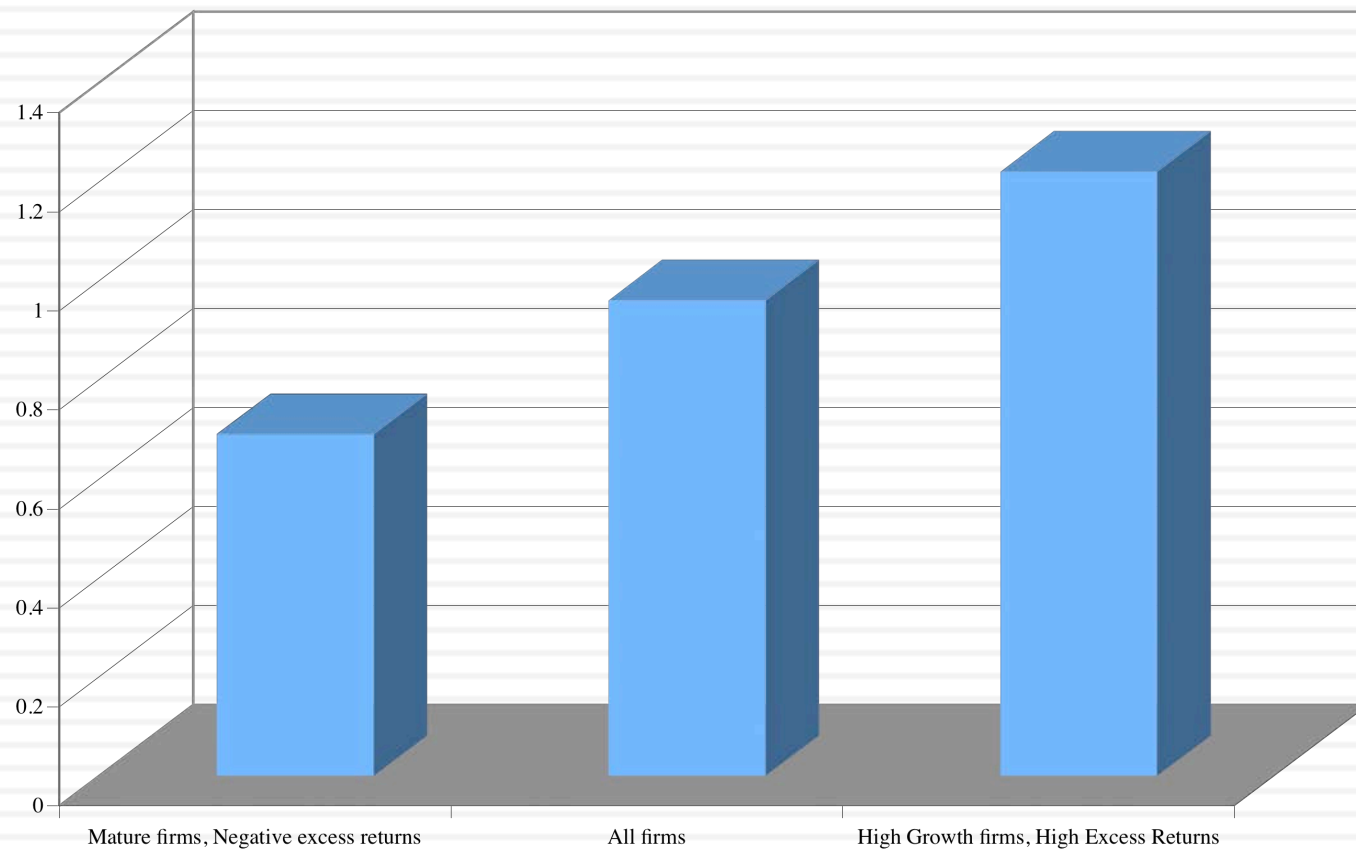

2. Dealing with Holdings in Other firms

- Holdings in other firms can be categorized into
 - Minority passive holdings, in which case only the dividend from the holdings is shown in the balance sheet
 - Minority active holdings, in which case the share of equity income is shown in the income statements
 - Majority active holdings, in which case the financial statements are consolidated.
- We tend to be sloppy in practice in dealing with cross holdings. After valuing the operating assets of a firm, using consolidated statements, it is common to add on the balance sheet value of minority holdings (which are in book value terms) and subtract out the minority interests (again in book value terms), representing the portion of the consolidated company that does not belong to the parent company.

How to value holdings in other firms.. In a perfect world..

- In a perfect world, we would strip the parent company from its subsidiaries and value each one separately. The value of the combined firm will be
 - ▣ Value of parent company + Proportion of value of each subsidiary
- To do this right, you will need to be provided detailed information on each subsidiary to estimate cash flows and discount rates.

Two compromise solutions...

- The market value solution: When the subsidiaries are publicly traded, you could use their traded market capitalizations to estimate the values of the cross holdings. You do risk carrying into your valuation any mistakes that the market may be making in valuation.
- The relative value solution: When there are too many cross holdings to value separately or when there is insufficient information provided on cross holdings, you can convert the book values of holdings that you have on the balance sheet (for both minority holdings and minority interests in majority holdings) by using the average price to book value ratio of the sector in which the subsidiaries operate.

Tata Motor's Cross Holdings

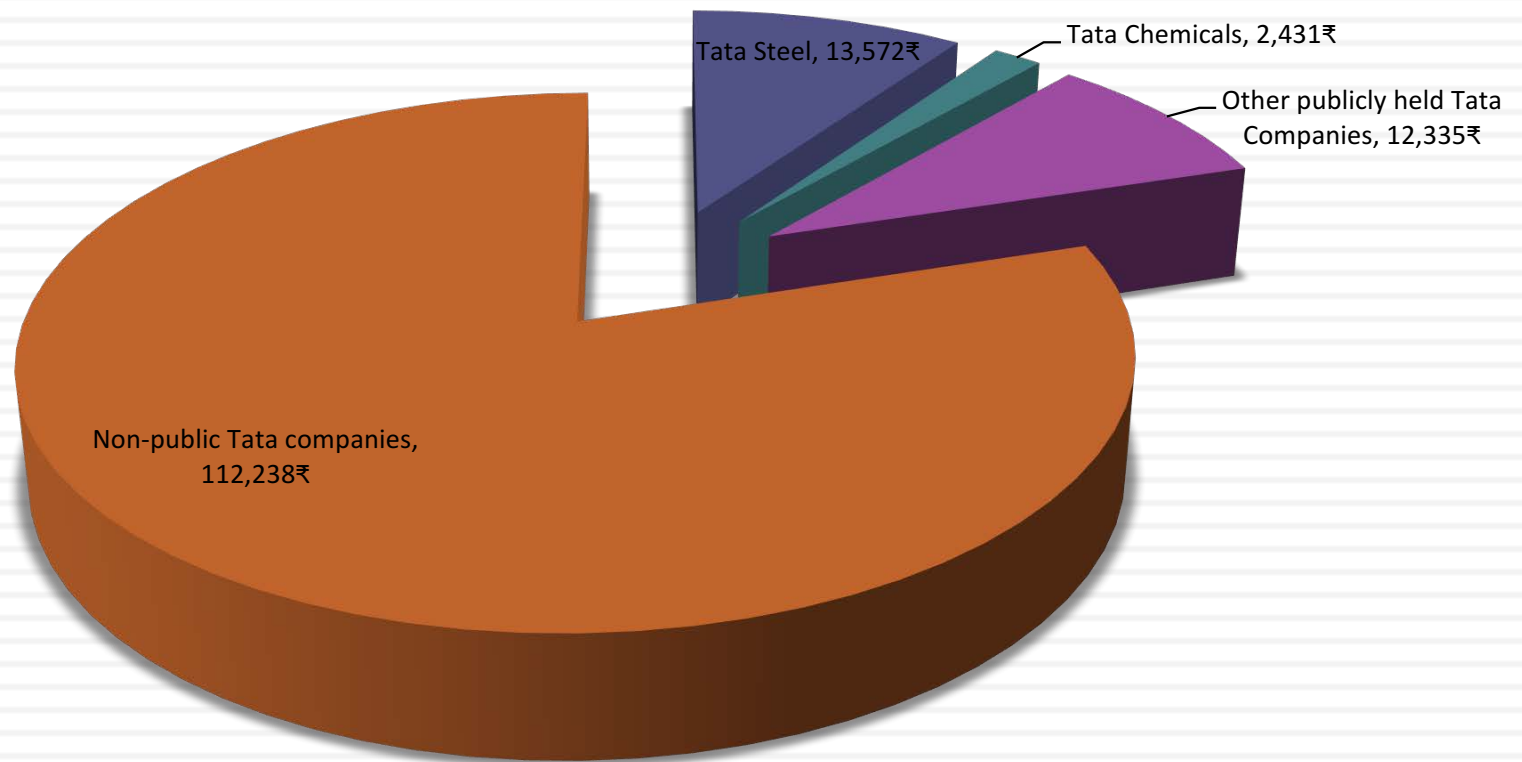

3. Other Assets that have not been counted yet..

- Unutilized assets: If you have assets or property that are not being utilized (vacant land, for example), you have not valued it yet. You can assess a market value for these assets and add them on to the value of the firm.
- Overfunded pension plans: If you have a defined benefit plan and your assets exceed your expected liabilities, you could consider the over funding with two caveats:
 - Collective bargaining agreements may prevent you from laying claim to these excess assets.
 - There are tax consequences. Often, withdrawals from pension plans get taxed at much higher rates.
- **Do not double count an asset.** If you count the income from an asset in your cash flows, you cannot count the market value of the asset in your value.

An Uncounted Asset?

64

Price tag: \$200 million



The longtime home of Playboy magazine founder Hugh Hefner is to be sold to Daren Metropoulos, a principal at private-equity firm Metropoulos & Co. PHOTO: GETTY IMAGES

4. A Discount for Complexity: An Experiment

	Company A	Company B
Operating Income	\$ 1 billion	\$ 1 billion
Tax rate	40%	40%
ROIC	10%	10%
Expected Growth	5%	5%
Cost of capital	8%	8%
Business Mix	Single	Multiple Businesses
Holdings	Simple	Complex
Accounting	Transparent	Opaque

□ Which firm would you value more highly?

Measuring Complexity: Volume of Data in Financial Statements

<i>Company</i>	<i>Number of pages in last 10Q</i>	<i>Number of pages in last 10K</i>
General Electric	65	410
Microsoft	63	218
Wal-mart	38	244
Exxon Mobil	86	332
Pfizer	171	460
Citigroup	252	1026
Intel	69	215
AIG	164	720
Johnson & Johnson	63	218
IBM	85	353

Measuring Complexity: A Complexity Score

Item	Factors	Follow-up Question	Answer	Weighting factor	Gerdau Score	GE Score
Operating Income	1. Multiple Businesses	Number of businesses (with more than 10% of revenues) =	1	2.00	2	30
	2. One-time income and expenses	Percent of operating income =	10%	10.00	1	0.8
	3. Income from unspecified sources	Percent of operating income =	0%	10.00	0	1.2
	4. Items in income statement that are volatile	Percent of operating income =	15%	5.00	0.75	1
Tax Rate	1. Income from multiple locales	Percent of revenues from non-domestic locales =	70%	3.00	2.1	1.8
	2. Different tax and reporting books	Yes or No	No	Yes=3	0	3
	3. Headquarters in tax havens	Yes or No	No	Yes=3	0	0
	4. Volatile effective tax rate	Yes or No	Yes	Yes=2	2	0
Capital Expenditures	1. Volatile capital expenditures	Yes or No	Yes	Yes=2	2	2
	2. Frequent and large acquisitions	Yes or No	Yes	Yes=4	4	4
	3. Stock payment for acquisitions and investments	Yes or No	No	Yes=4	0	4
Working capital	1. Unspecified current assets and current liabilities	Yes or No	No	Yes=3	0	0
	2. Volatile working capital items	Yes or No	Yes	Yes=2	2	2
Expected Growth rate	1. Off-balance sheet assets and liabilities (operating leases and R&D)	Yes or No	No	Yes=3	0	3
	2. Substantial stock buybacks	Yes or No	No	Yes=3	0	3
	3. Changing return on capital over time	Is your return on capital volatile?	Yes	Yes=5	5	5
	4. Unsustainably high return	Is your firm's ROC much higher than industry average?	No	Yes=5	0	0
Cost of capital	1. Multiple businesses	Number of businesses (more than 10% of revenues) =	1	1.00	1	20
	2. Operations in emerging markets	Percent of revenues=	50%	5.00	2.5	2.5
	3. Is the debt market traded?	Yes or No	No	No=2	2	0
	4. Does the company have a rating?	Yes or No	Yes	No=2	0	0
	5. Does the company have off-balance sheet debt?	Yes or No	No	Yes=5	0	5
No-operating assets	Minority holdings as percent of book assets	Minority holdings as percent of book assets	0%	20.00	0	0.8
Firm to Equity value	Consolidation of subsidiaries	Minority interest as percent of book value of equity	63%	20.00	12.6	1.2
Per share value	Shares with different voting rights	Does the firm have shares with different voting rights?	Yes	Yes = 10	10	0
	Equity options outstanding	Options outstanding as percent of shares	0%	10.00	0	0.67
Complexity Score =					48.95	90.55

Dealing with Complexity

□ In Discounted Cashflow Valuation

- The Aggressive Analyst: Trust the firm to tell the truth and value the firm based upon the firm's statements about their value.
- The Conservative Analyst: Don't value what you cannot see.
- The Compromise: Adjust the value for complexity
 - Adjust cash flows for complexity
 - Adjust the discount rate for complexity
 - Adjust the expected growth rate/ length of growth period
 - Value the firm and then discount value for complexity

□ In relative valuation

- In a relative valuation, you may be able to assess the price that the market is charging for complexity:
- With the hundred largest market cap firms, for instance:

$$\text{PBV} = 0.65 + 15.31 \text{ ROE} - 0.55 \text{ Beta} + 3.04 \text{ Expected growth rate} - 0.003 \# \text{ Pages in 10K}$$

5. The Value of Synergy

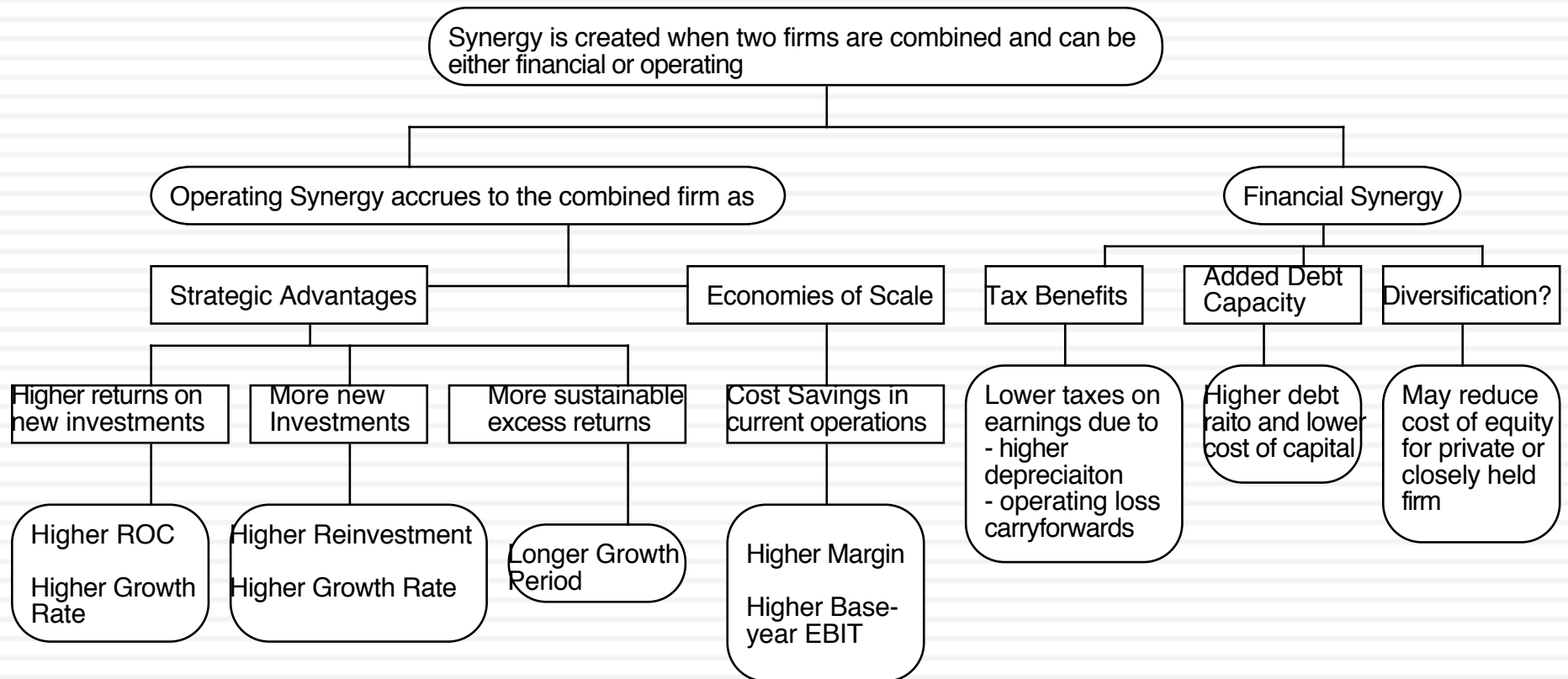

Valuing Synergy

- (1) the firms involved in the merger are valued independently, by discounting expected cash flows to each firm at the weighted average cost of capital for that firm.
- (2) the value of the combined firm, with no synergy, is obtained by adding the values obtained for each firm in the first step.
- (3) The effects of synergy are built into expected growth rates and cashflows, and the combined firm is re-valued with synergy.

Value of Synergy = Value of the combined firm, with synergy - Value of the combined firm, without synergy

Inbev + SAB Miller: Where's the synergy?

	<i>Inbev</i>	<i>SABMiller</i>	<i>Combined firm (status quo)</i>	<i>Combined firm (synergy)</i>
Levered Beta	0.85	0.8289	0.84641	0.84641
Pre-tax cost of debt	3.0000%	3.2000%	3.00%	3.00%
Effective tax rate	18.00%	26.36%	19.92%	19.92%
Debt to Equity Ratio	30.51%	23.18%	29.71%	29.71%
Revenues	\$45,762.00	\$22,130.00	\$67,892.00	\$67,892.00
Operating Margin	32.28%	19.97%	28.27%	30.00%
Operating Income (EBIT)	\$14,771.97	\$4,419.36	\$19,191.33	\$20.368
After-tax return on capital	12.10%	12.64%	11.68%	12.00%
Reinvestment Rate =	50.99%	33.29%	43.58%	50.00%
Expected Growth Rate	6.17%	4.21%	5.09%	6.00%

The value of synergy

	<i>Inbev</i>	<i>SABMiller</i>	<i>Combined firm (status quo)</i>	<i>Combined firm (synergy)</i>
Cost of Equity =	8.93%	9.37%	9.12%	9.12%
After-tax cost of debt =	2.10%	2.24%	2.10%	2.10%
Cost of capital =	7.33%	8.03%	7.51%	7.51%
After-tax return on capital =	12.10%	12.64%	11.68%	12.00%
Reinvestment Rate =	50.99%	33.29%	43.58%	50.00%
Expected growth rate=	6.17%	4.21%	5.09%	6.00%
<i>Value of firm</i>				
PV of FCFF in high growth =	\$28,733	\$9,806	\$38,539	\$39,151
Terminal value =	\$260,982	\$58,736	\$319,717	\$340,175
Value of operating assets =	\$211,953	\$50,065	\$262,018	\$276,610

Value of synergy = 276,610 – 262,018 = 14,592 million 72

6. Brand name, great management, superb product ...Are we short changing intangibles?

- There is often a temptation to add on premiums for intangibles. Here are a few examples.
 - ▣ Brand name
 - ▣ Great management
 - ▣ Loyal workforce
 - ▣ Technological prowess
- There are two potential dangers:
 - ▣ For some assets, the value may already be in your value and adding a premium will be double counting.
 - ▣ For other assets, the value may be ignored but incorporating it will not be easy.

Valuing Brand Name

	Coca Cola	With Cott Margins
Current Revenues =	\$21,962.00	\$21,962.00
Length of high-growth period	10	10
Reinvestment Rate =	50%	50%
Operating Margin (after-tax)	15.57%	5.28%
Sales/Capital (Turnover ratio)	1.34	1.34
Return on capital (after-tax)	20.84%	7.06%
Growth rate during period (g) =	10.42%	3.53%
Cost of Capital during period =	7.65%	7.65%
Stable Growth Period		
Growth rate in steady state =	4.00%	4.00%
Return on capital =	7.65%	7.65%
Reinvestment Rate =	52.28%	52.28%
Cost of Capital =	7.65%	7.65%
Value of Firm =	\$79,611.25	\$15,371.24

Valuing a Franchise: Star Wars

Star Wars Franchise Valuation: December 2015

	Add-on \$ per Box Office \$
Streaming/Video	\$1.20
Toys & Merchandise	\$2.00
Books/eBooks	\$0.20
Gaming	\$0.50
Other	\$0.50

Main Movies
World Box office of \$1.5 billion,
adjusted for 2% inflation.

Spin Off Movies
World Box office is 50% of
main movies.

	Main Star Wars Movies			Star Wars Spin offs		
	Star Wars VII	Star Wars VIII	Star Wars IX	Rogue One	Hans Solo?	Boba Fett?
Years from now	0.0	2.0	4.0	1.0	3.0	5.0
Movies - Revenues	\$2,000	\$2,081	\$2,165	\$1,020	\$1,061	\$1,104
Streaming/Video - Revenues	\$2,400	\$2,497	\$2,598	\$1,224	\$1,273	\$1,325
Toys & Merchandise - Revenues	\$4,000	\$4,162	\$4,330	\$2,040	\$2,122	\$2,208
Books/eBooks - Revenues	\$400	\$416	\$433	\$204	\$212	\$221
Gaming - Revenues	\$1,000	\$1,040	\$1,082	\$510	\$531	\$552
Other - Revenues	\$1,000	\$1,040	\$1,082	\$510	\$531	\$552
Total - Revenues	\$10,800	\$11,236	\$11,690	\$5,508	\$5,731	\$5,962
After-tax Operating Income (movies)	\$ 282	\$ 293	\$ 305	\$ 144	\$ 150	\$ 156
After-tax Operating Income (non-movies)	\$ 924	\$ 961	\$ 1,000	\$ 471	\$ 490	\$ 510
Present Value	\$ 1,206	\$ 1,083	\$ 973	\$ 572	\$ 514	\$ 461
Value of new Star Wars movies =	\$4,809					
Value of continuing income =	\$5,163					
Value of Star Wars =	\$9,972					

Operating Margin
20.14% for movies
15% for non-movies
30% tax rate

Discounted back
@ 7.61% cost of
capital of
entertainment
companies

Assumes that revenues from add ons
continue after 2020, growing at 2% a year,
with 15% operating margin

7. Be circumspect about defining debt for cost of capital purposes...

- General Rule: Debt generally has the following characteristics:
 - ▣ Commitment to make fixed payments in the future
 - ▣ The fixed payments are tax deductible
 - ▣ Failure to make the payments can lead to either default or loss of control of the firm to the party to whom payments are due.
- Defined as such, debt should include
 - ▣ All interest bearing liabilities, short term as well as long term
 - ▣ All leases, operating as well as capital
- Debt should not include
 - ▣ Accounts payable or supplier credit

But should consider other potential liabilities when getting to equity value...

- If you have under funded pension fund or health care plans, you should consider the under funding at this stage in getting to the value of equity.
 - If you do so, you should not double count by also including a cash flow line item reflecting cash you would need to set aside to meet the unfunded obligation.
 - You should not be counting these items as debt in your cost of capital calculations....
- If you have contingent liabilities - for example, a potential liability from a lawsuit that has not been decided - you should consider the expected value of these contingent liabilities
 - Value of contingent liability = Probability that the liability will occur * Expected value of liability

8. The Value of Control

- The value of the control premium that will be paid to acquire a block of equity will depend upon two factors -
 - Probability that control of firm will change: This refers to the probability that incumbent management will be replaced. this can be either through acquisition or through existing stockholders exercising their muscle.
 - Value of Gaining Control of the Company: The value of gaining control of a company arises from two sources - the increase in value that can be wrought by changes in the way the company is managed and run, and the side benefits and perquisites of being in control
 - Value of Gaining Control = Present Value (Value of Company with change in control - Value of company without change in control) + Side Benefits of Control

Increase Cash Flows

Reduce the cost of capital

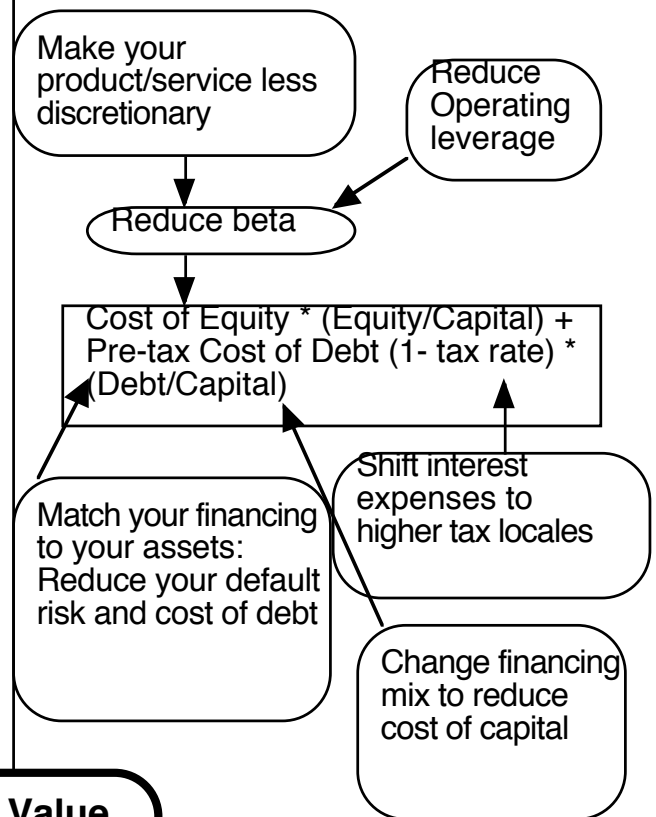
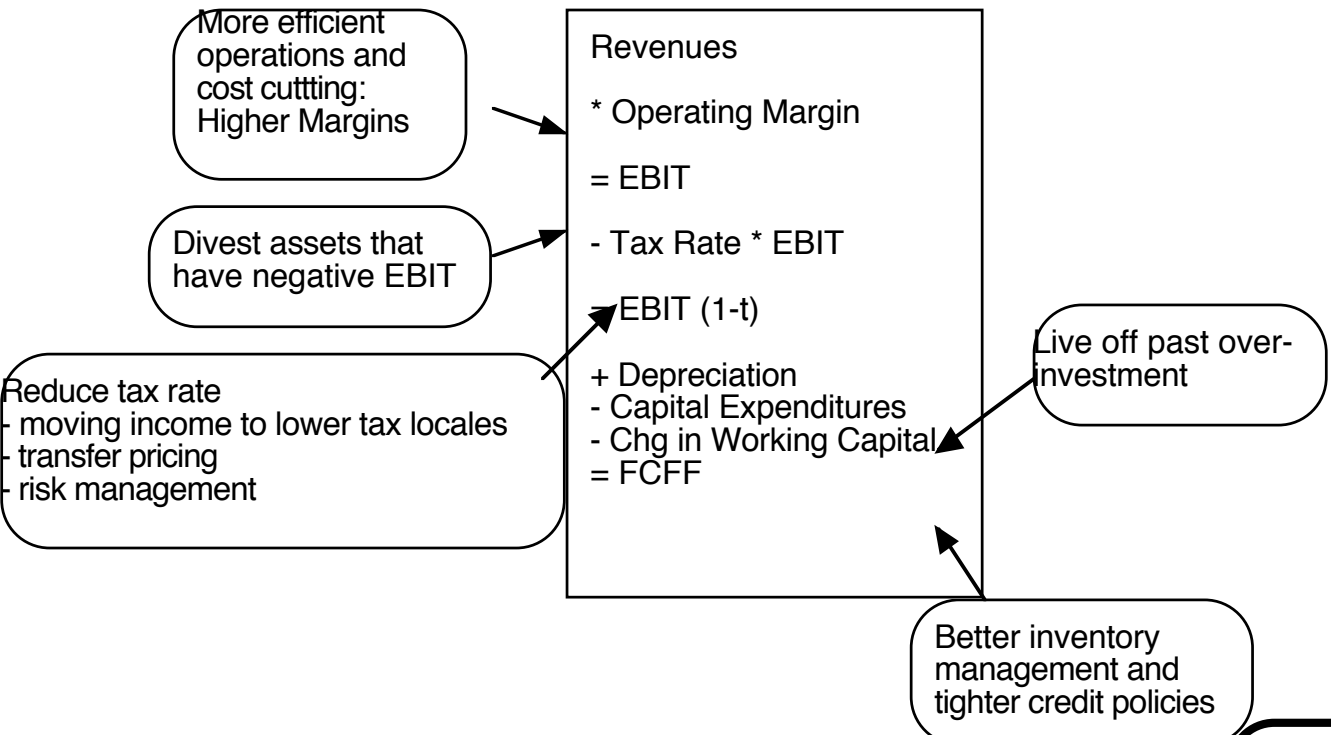

Firm Value

Increase Expected Growth

Increase length of growth period

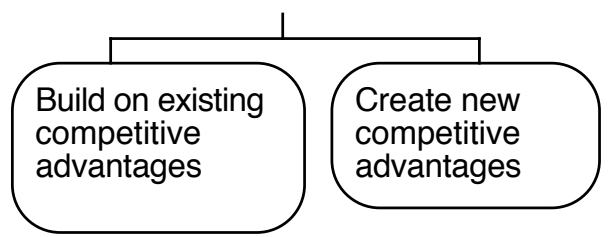
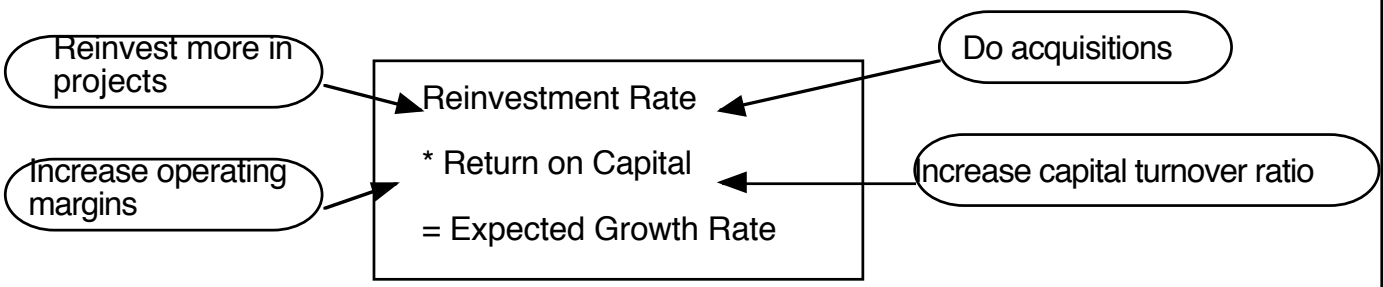

Adris Grupa: 4/2010 (Restructured)

Current Cashflow to Firm
 EBIT(1-t) : 436 HRK
 - Nt CpX 3 HRK
 - Chg WC -118 HRK
 = FCFF 551 HRK
 Reinv Rate= (3-118)/436=-26.35%;
 Tax rate = 17.35%
 Return on capital = 8.72%

Increased ROIC to cost of capital

Reinvestment Rate
70.83%

Expected Growth from new inv.
 $.7083 \times .01054 = 0.00746$
 or 6.86%

Return on Capital
10.54%

Stable Growth
 g = 4%; Beta = 0.80
 Country Premium= 2%
 Cost of capital = 9.65%
 Tax rate = 20.00%
 ROC=9.65%;
 Reinvestment Rate=g/ROC
 $= 4/9.65\% = 41.47\%$

Op. Assets 4545
 + Cash: 1787
 - Debt 141
 - Minority int 465
 =Equity 5,735
 Value/non-voting 334
 Value/voting 362

Year	1	2	3	4	5	Terminal Value
EBIT (1-t)	HRK 469	HRK 503	HRK 541	HRK 581	HRK 623	628
- Reinvestment	HRK 332	HRK 356	HRK 383	HRK 411	HRK 442	246
FCFF	HRK 137	HRK 147	HRK 158	HRK 169	HRK 182	367

Terminal Value₅ = $367 / (.0965 - .04) = 6508$ HRK

Discount at \$ Cost of Capital (WACC) = $11.12\% (.90) + 8.20\% (0.10) = 10.54\%$

Changed mix of debt and equity to optimal

Cost of Equity
11.12%

Cost of Debt
 $(4.25\% + 4\% + 2\%) (1 - .20) = 8.20\%$

Weights
E = 90 % D = 10 %

On May 1, 2010
 AG Pfd price = 279 HRK
 AG Common = 345 HRK

Riskfree Rate:
HRK Riskfree Rate= 4.25%

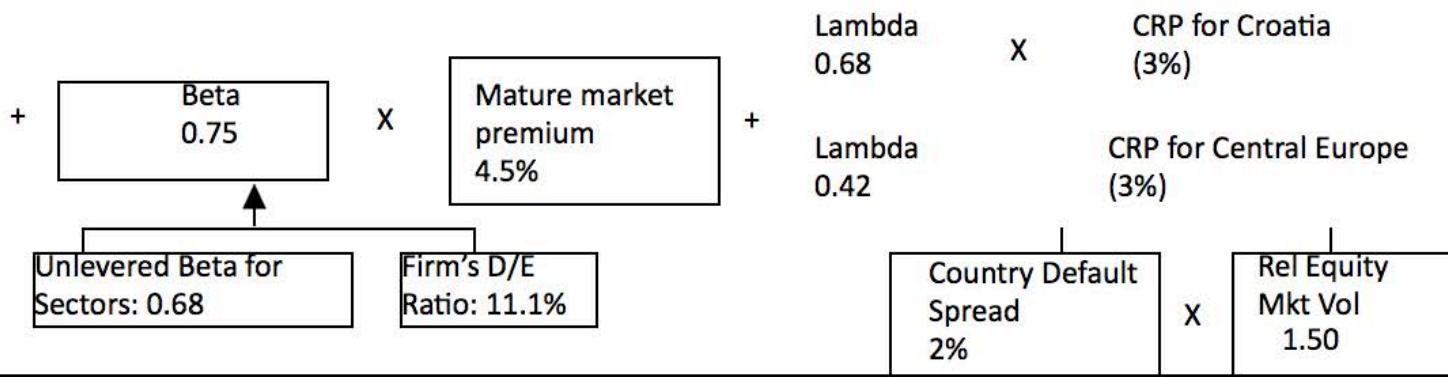

Value of Control and the Value of Voting Rights

- Adris Grupa has two classes of shares outstanding: 9.616 million voting shares and 6.748 million non-voting shares.
- To value a non-voting share, we assume that all non-voting shares essentially have to settle for status quo value. All shareholders, common and preferred, get an equal share of the status quo value.

Status Quo Value of Equity = 5,484 million HKR

Value for a non-voting share = $5484 / (9.616 + 6.748) = 334$ HKR/share

- To value a voting share, we first value control in Adris Grup as the difference between the optimal and the status quo value:

Value of control at Adris Grupa = $5,735 - 5484 = 249$ million HKR

- If you assume a 100% probability of change occurring, the value per voting share can be written as:

Value per voting share = $334 \text{ HKR} + 249 / 9.616 = 362$ HKR

- If the probability of control changing is only 40%, the expected value of control and value per voting share can be written as follows:

- Expected value of control = $249 (.4) = 99.6$ million HKR

- Value per voting share = $334 \text{ HKR} + 99.6 / 9.616 = 344$ HKR

Henkel: Debt Capacity?

Debt Ratio	Beta	Cost of Equity	Bond Rating	Interest rate on debt	Tax Rate	Cost of Debt (after-tax)	WACC
0%	0.9751	7.55%	Aaa/AAA	0.43%	29.65%	0.30%	7.55%
4.2%	1.0052	7.78%	A2	1.03%	29.65%	0.72%	7.48%
10%	1.0565	8.17%	A2	1.03%	29.65%	0.72%	7.43%
20%	1.1522	8.91%	A2	1.03%	29.65%	0.72%	7.27%
30%	1.2753	9.86%	A3	1.28%	29.65%	0.90%	7.17%
40%	1.4395	11.13%	A3	1.28%	29.65%	0.90%	7.04%
50%	1.6692	12.90%	Ba1	2.78%	29.65%	1.96%	7.43%
60%	2.1966	16.96%	B1	4.03%	29.65%	2.84%	8.49%
70%	2.9288	22.61%	C2	7.03%	21.33%	5.53%	10.65%
80%	4.3932	33.89%	Ca2	8.03%	18.55%	6.54%	12.01%
90%	8.7863	67.75%	Ca3	10.03%	11.48%	8.88%	14.77%

Henkel Restructured: October 2016 (in Euros)

Cash flows from existing assets

	LTM	Last 10 years
Revenues	\$ 18,074	Growth rate = 4.20%
Operating margin	15.25%	Average = 12.80%
Sales/Invested Capital	1.33	Average = 1.52
Return on Invested Capital	15.26%	Average = 14.48%
Effective Tax Rate	24.20%	Average = 25.00%

The Payoff from growth

Revenues will grow 5% a year for next 5 years, tapering down to 0.1% growth in year 10

Operating margin (per-tax) will remain at LTM level of 15.26%

Sales/Invested Capital will remain at LTM level of 1.33

Maturity and Closure

Stable Growth
 $g = 0.1\%$;
 Cost of capital = 7%
 $ROC = 7\%$;
 Reinvestment Rate = $g/ROC = 0.03\%/7\% = 0.42\%$

Terminal Value = $2,902 / (.07 - 0.0003) = 41,639$

Euro Cashflows

	Base year	1	2	3	4	5	6	7	8	9	10	Terminal year
Revenue growth rate		5.00%	5.00%	5.00%	5.00%	5.00%	4.01%	3.01%	2.02%	1.02%	0.03%	0.03%
Revenues	€ 18,074	€ 18,978	€ 19,927	€ 20,923	€ 21,969	€ 23,068	€ 23,992	€ 24,714	€ 25,213	€ 25,471	€ 25,479	€ 25,486
EBIT (Operating) margin	15.25%	15.25%	15.25%	15.25%	15.25%	15.25%	15.25%	15.25%	15.25%	15.25%	15.25%	15.25%
EBIT (Operating income)	€ 2,756	€ 2,894	€ 3,038	€ 3,190	€ 3,350	€ 3,517	€ 3,658	€ 3,769	€ 3,845	€ 3,884	€ 3,885	€ 3,886
Tax rate	25.00%	25.00%	25.00%	25.00%	25.00%	25.00%	25.00%	25.00%	25.00%	25.00%	25.00%	25.00%
EBIT(1-t)	€ 2,067	€ 2,170	€ 2,279	€ 2,393	€ 2,512	€ 2,638	€ 2,744	€ 2,826	€ 2,883	€ 2,913	€ 2,914	€ 2,915
- Reinvestment	€ 677	€ 711	€ 747	€ 784	€ 823	€ 863	€ 893	€ 924	€ 949	€ 966	€ 974	€ 974
FCFF		€ 1,493	€ 1,568	€ 1,646	€ 1,728	€ 1,815	€ 1,901	€ 1,985	€ 2,051	€ 2,119	€ 2,198	€ 2,902

Discount at $\$$ Cost of Capital (WACC) = $11.13\% \cdot 0.60 + 0.90\% \cdot 0.40 = 7.04\%$

The Risk in the Cash flows

On October 25, 2016, Henkel was trading at 118 Euros per share

Cost of Equity
11.13%

Cost of Debt
 $(0.03\% + 1.25\%)(1 - 0.2965) = 0.90\%$

Weights
 $E = 60\% \quad D = 40\%$

Riskfree Rate:
Euro Risk free rate = 0.03%

Beta = 1.44

Firm's D/E
Ratio: 66.67%

Business	Estimated Value	Weight	Unlevered Beta
Chemical (Specialty)	€ 16,276	35.61%	1.03
Household Products	€ 14,486	31.69%	0.96
Cosmetics/Toiletries	€ 14,949	32.70%	0.93
Henkel	€ 45,711		0.98

ERP = 7.71%

Region	Revenues	Weight	ERP
Africa	€ 600	3.34%	11.76%
Asia	€ 3,134	17.45%	7.49%
Central and South America	€ 1,110	6.18%	10.42%
Eastern Europe & Russia	€ 2,695	15.00%	9.65%
Middle East	€ 729	4.06%	7.11%
North America	€ 3,648	20.31%	6.00%
Western Europe	€ 6,045	33.66%	7.16%
Henkel	€ 17,961	100.00%	7.71%

Aswath Damodaran



THE DARK SIDE OF VALUATION: VALUING DIFFICULT-TO-VALUE COMPANIES

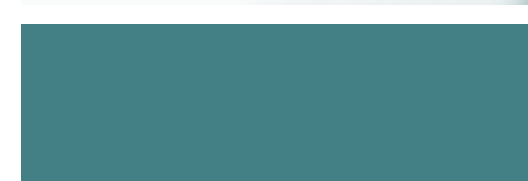

The fundamental determinants of value...

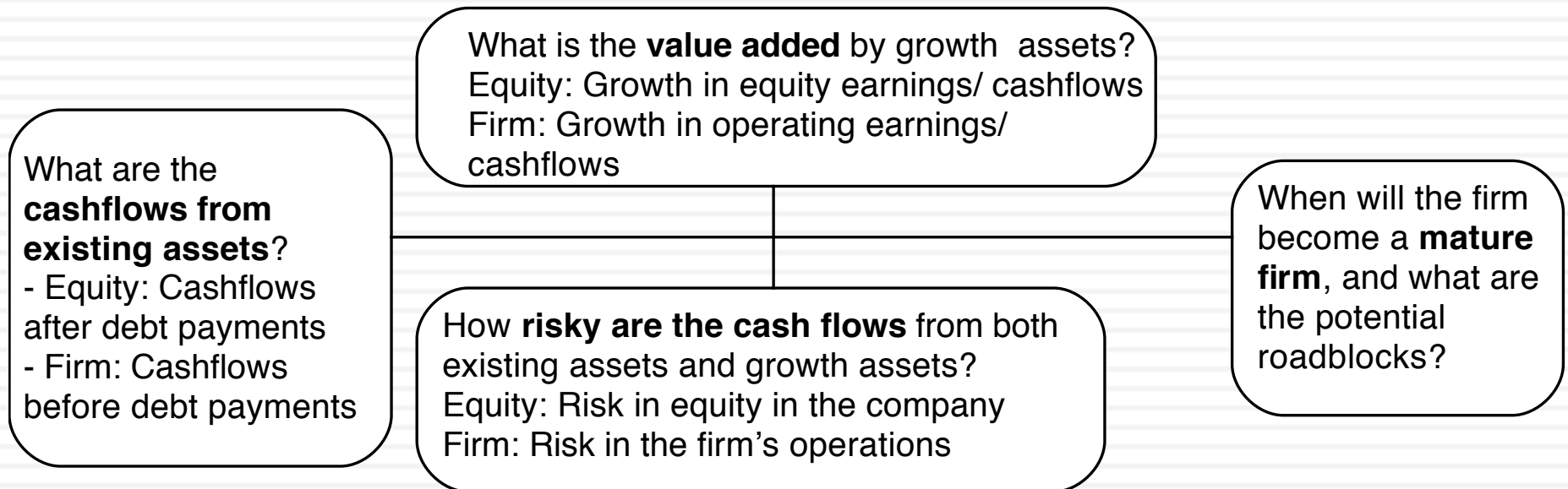

The Dark Side of Valuation...

- Valuing stable, money making companies with consistent and clear accounting statements, a long and stable history and lots of comparable firms is easy to do.
- The true test of your valuation skills is when you have to value “difficult” companies. In particular, the challenges are greatest when valuing:
 - ▣ Young companies, early in the life cycle, in young businesses
 - ▣ Companies that don’t fit the accounting mold
 - ▣ Companies that face substantial truncation risk (default or nationalization risk)

Difficult to value companies...

- Across the life cycle:
 - ▣ Young, growth firms: Limited history, small revenues in conjunction with big operating losses and a propensity for failure make these companies tough to value.
 - ▣ Mature companies in transition: When mature companies change or are forced to change, history may have to be abandoned and parameters have to be reestimated.
 - ▣ Declining and Distressed firms: A long but irrelevant history, declining markets, high debt loads and the likelihood of distress make them troublesome.
- Across sectors
 - ▣ Financial service firms: Opacity of financial statements and difficulties in estimating basic inputs leave us trusting managers to tell us what's going on.
 - ▣ Commodity and cyclical firms: Dependence of the underlying commodity prices or overall economic growth make these valuations susceptible to macro factors.
 - ▣ Firms with intangible assets: Accounting principles are left to the wayside on these firms.
- Across the ownership cycle
 - ▣ Privately owned businesses: Exposure to firm specific risk and illiquidity bedevil valuations.
 - ▣ Venture Capital (VC) and private equity: Different equity investors, with different perceptions of risk.
 - ▣ Closely held public firms: Part private and part public, sharing the troubles of both.

I. The challenge with young companies...

Figure 5.2: Estimation Issues - Young and Start-up Companies

Making judgments on revenues/ profits difficult because you cannot draw on history. If you have no product/ service, it is difficult to gauge market potential or profitability. The company's entire value lies in future growth but you have little to base your estimate on.

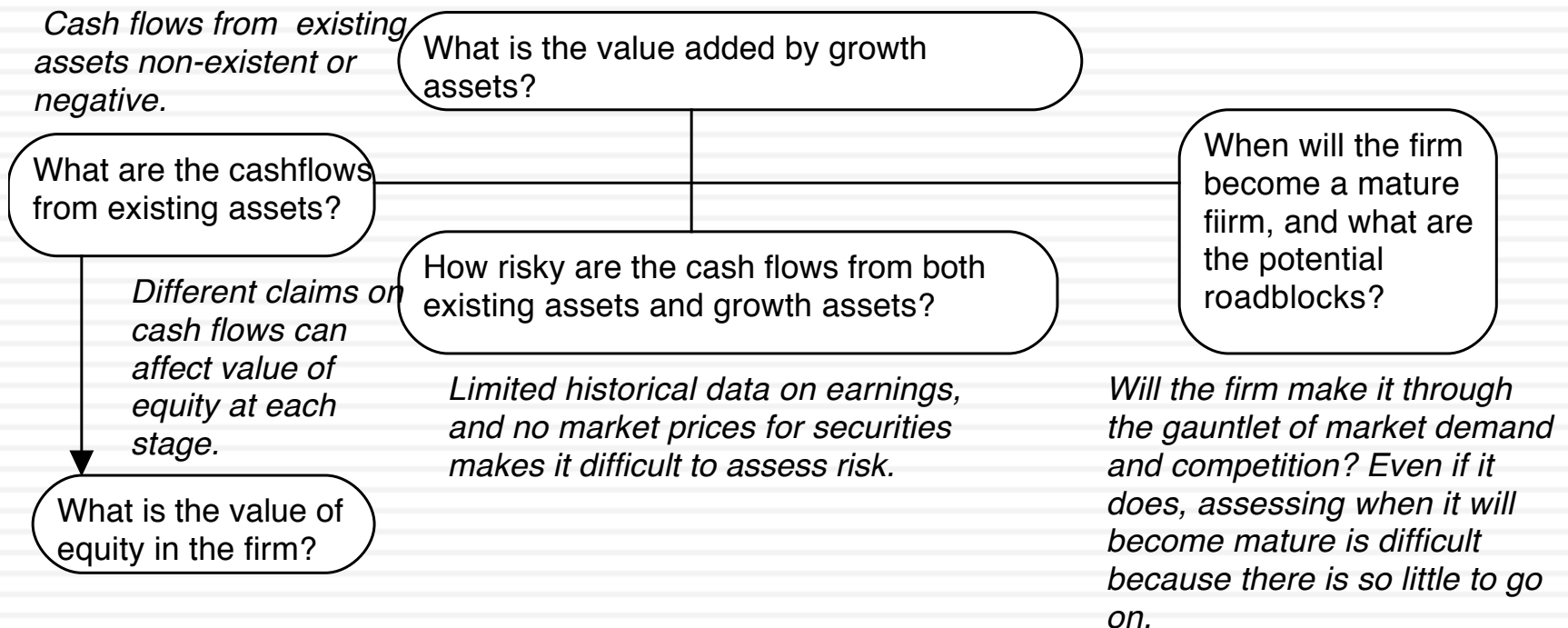

Upping the ante.. Young companies in young businesses...

- When valuing a business, we generally draw on three sources of information
 - ▣ The firm's current financial statement
 - How much did the firm sell?
 - How much did it earn?
 - ▣ The firm's financial history, usually summarized in its financial statements.
 - How fast have the firm's revenues and earnings grown over time?
 - What can we learn about cost structure and profitability from these trends?
 - Susceptibility to macro-economic factors (recessions and cyclical firms)
 - ▣ The industry and comparable firm data
 - What happens to firms as they mature? (Margins.. Revenue growth... Reinvestment needs... Risk)
- It is when valuing these companies that you find yourself tempted by the dark side, where
 - ▣ "Paradigm shifts" happen...
 - ▣ New metrics are invented ...
 - ▣ The story dominates and the numbers lag...

Amazon in January 2000

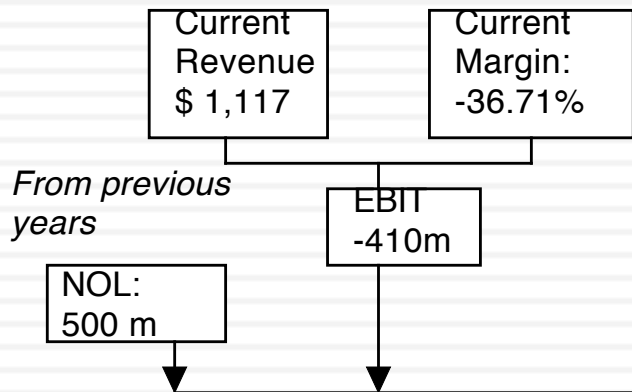

Sales to capital ratio and expected margin are retail industry average numbers

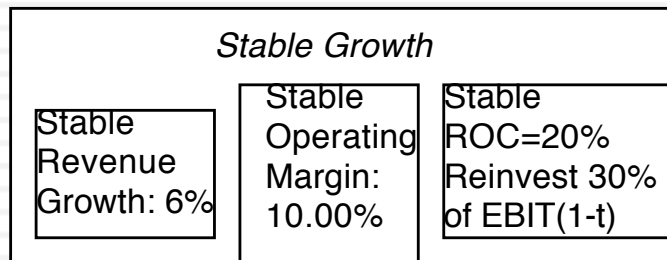
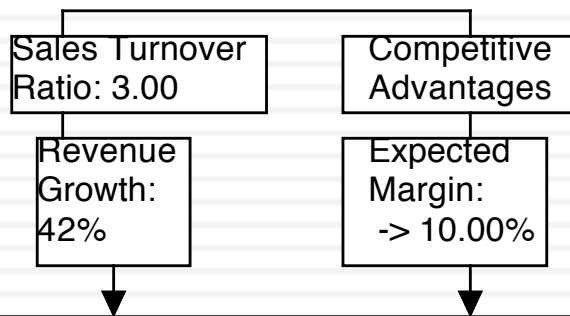

Terminal Value = $1881 / (.0961 - .06)$ = 52,148

Value of Op Assets \$ 15,170

+ Cash \$ 26

= Value of Firm \$15,196

- Value of Debt \$ 349

= Value of Equity \$14,847

- Equity Options \$ 2,892

Value per share \$ 35.08

All existing options valued as options, using current stock price of \$84.

Revenue Growth	150.00%	100.00%	75.00%	50.00%	30.00%	25.20%	20.40%	15.60%	10.80%	6.00%
Revenues	\$ 2,793	\$ 5,585	\$ 9,774	\$ 14,661	\$ 19,059	\$ 23,862	\$ 28,729	\$ 33,211	\$ 36,798	\$ 39,006
Operating Margin	-13.35%	-1.68%	4.16%	7.08%	8.54%	9.27%	9.64%	9.82%	9.91%	9.95%
EBIT	-\$373	-\$94	\$407	\$1,038	\$1,628	\$2,212	\$2,768	\$3,261	\$3,646	\$3,883
EBIT(1-t)	-\$373	-\$94	\$407	\$871	\$1,058	\$1,438	\$1,799	\$2,119	\$2,370	\$2,524
- Reinvestment	\$600	\$967	\$1,420	\$1,663	\$1,543	\$1,688	\$1,721	\$1,619	\$1,363	\$961
FCFF	-\$931	-\$1,024	-\$989	-\$758	-\$408	-\$163	\$177	\$625	\$1,174	\$1,788

Term. Year	6%
	\$ 41,346
	10.00%
	\$4,135
	\$2,688
	\$155
	\$1,881

		1	2	3	4	5	6	7	8	9	10	Forever
Cost of Equity		12.90%	12.90%	12.90%	12.90%	12.90%	12.42%	11.94%	11.46%	10.98%	10.50%	
Cost of Debt		8.00%	8.00%	8.00%	8.00%	8.00%	7.80%	7.75%	7.67%	7.50%	7.00%	
After-tax cost of debt		8.00%	8.00%	8.00%	6.71%	5.20%	5.07%	5.04%	4.98%	4.88%	4.55%	
Cost of Capital		12.84%	12.84%	12.84%	12.83%	12.81%	12.13%	11.62%	11.08%	10.49%	9.61%	

Cost of Equity 12.90%

Used average interest coverage ratio over next 5 years to get BBB rating.

Cost of Debt 6.5%+1.5%=8.0%
Tax rate = 0% -> 35%

Weights Debt= 1.2% -> 15%

Amazon was trading at \$84 in January 2000.

Pushed debt ratio to retail industry average of 15%.

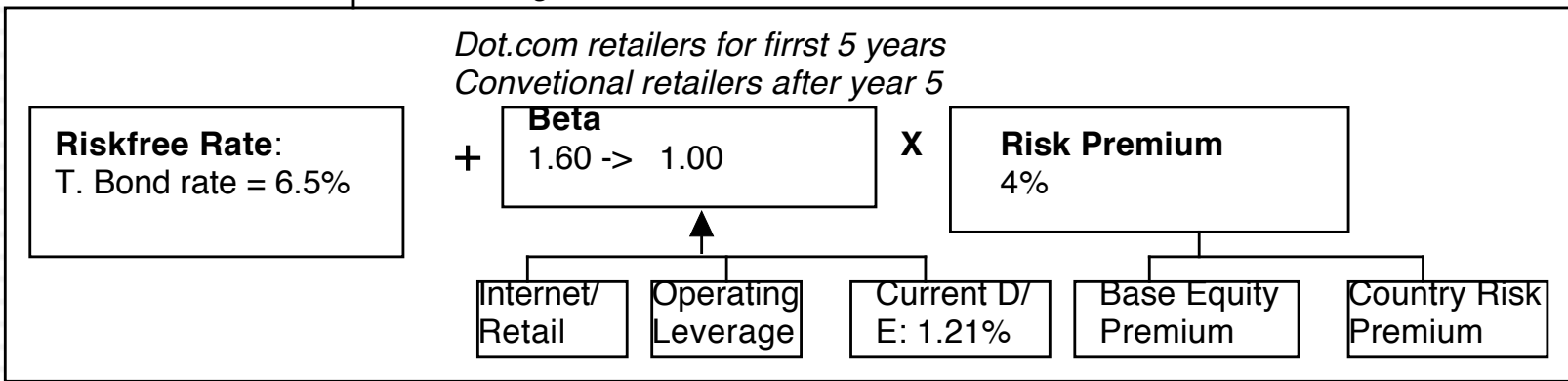

Lesson 1: Don't trust regression betas....

<HELP> for explanation, <MENU> for similar functions.

DG26 Equity **BETA**

HISTORICAL BETA

AMZN

US

AMAZON.COM INC

Relative Index

SPX

S&P 500 INDEX

* Identifies latest observation

Period Weekly

Range 2/27/98 To 2/18/00

Market Trade

ADJ BETA	1.82
RAW BETA	2.23
Alpha (Intercept)	2.60
R2 (Correlation)	.17
Std Dev of Error	13.20
Std Error of Beta	.50
Number of Points	103

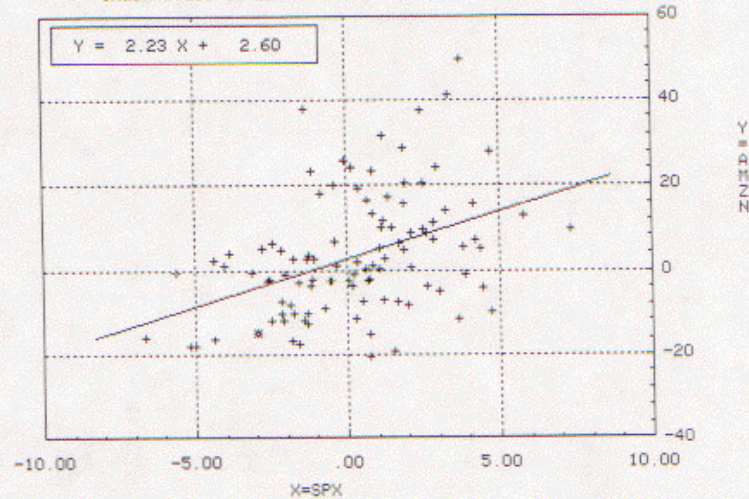

Adj beta = (0.67) * Raw Beta
+ (0.33) * 1.0

Copyright 2000 BLOOMBERG L.P. Frankfurt:69-920410 Hong Kong:2-977-6000 London:171-330-7500 New York:212-318-2000
Princeton:609-279-3000 Singapore:226-3000 Sydney:2-9777-8686 Tokyo:3-3201-8900 Sao Paulo:11-3048-4500
1257-602-0 22-Feb-00 16:21:23

Bloomberg
PROFESSIONAL

Lesson 2: Work backwards and keep it simple...

Year	Revenue Growth	Sales	Operating Margin	EBIT	EBIT (1-t)
Tr 12 mths		\$1,117	-36.71%	-\$410	-\$410
1	150.00%	\$2,793	-13.35%	-\$373	-\$373
2	100.00%	\$5,585	-1.68%	-\$94	-\$94
3	75.00%	\$9,774	4.16%	\$407	\$407
4	50.00%	\$14,661	7.08%	\$1,038	\$871
5	30.00%	\$19,059	8.54%	\$1,628	\$1,058
6	25.20%	\$23,862	9.27%	\$2,212	\$1,438
7	20.40%	\$28,729	9.64%	\$2,768	\$1,799
8	15.60%	\$33,211	9.82%	\$3,261	\$2,119
9	10.80%	\$36,798	9.91%	\$3,646	\$2,370
10	6.00%	\$39,006	9.95%	\$3,883	\$2,524
TY	6.00%	\$41,346	10.00%	\$4,135	\$2,688

Lesson 3: Scaling up is hard to do...

Typically, the revenue growth rate of a newly public company outpaces its industry average for only about five years.

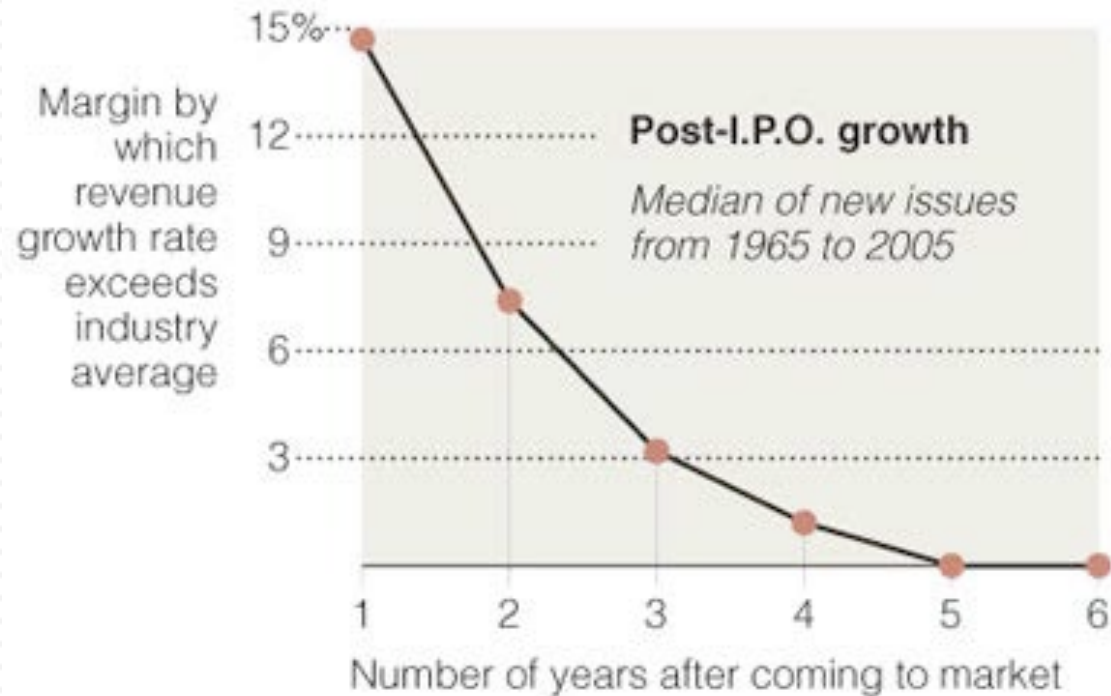

Source: Andrew Metrick

The New York Times

Lesson 4: Don't forget to pay for growth...

Year	Revenues	Δ Revenue	Sales/Cap	Δ Investment	Invested Capital	EBIT (1-t)	Imputed ROC
Tr 12 mths	\$1,117				\$ 487	-\$410	
1	\$2,793	\$1,676	3.00	\$559	\$ 1,045	-\$373	-76.62%
2	\$5,585	\$2,793	3.00	\$931	\$ 1,976	-\$94	-8.96%
3	\$9,774	\$4,189	3.00	\$1,396	\$ 3,372	\$407	20.59%
4	\$14,661	\$4,887	3.00	\$1,629	\$ 5,001	\$871	25.82%
5	\$19,059	\$4,398	3.00	\$1,466	\$ 6,467	\$1,058	21.16%
6	\$23,862	\$4,803	3.00	\$1,601	\$ 8,068	\$1,438	22.23%
7	\$28,729	\$4,868	3.00	\$1,623	\$ 9,691	\$1,799	22.30%
8	\$33,211	\$4,482	3.00	\$1,494	\$ 11,185	\$2,119	21.87%
9	\$36,798	\$3,587	3.00	\$1,196	\$ 12,380	\$2,370	21.19%
10	\$39,006	\$2,208	3.00	\$736	\$ 13,116	\$2,524	20.39%
TY	\$41,346	\$2,340	NA		Assumed to be =		20.00%

Lesson 5: There are always scenarios where the market price can be justified...

		Target pre-tax Operating Margin				
		6%	8%	10%	12%	14%
Compounded annual Revenue Growth rate	30%	\$ (1.94)	\$ 2.95	\$ 7.84	\$ 12.71	\$ 17.57
	35%	\$ 1.41	\$ 8.37	\$ 15.33	\$ 22.27	\$ 29.21
	40%	\$ 6.10	\$ 15.93	\$ 25.74	\$ 35.54	\$ 45.34
	45%	\$ 12.59	\$ 26.34	\$ 40.05	\$ 53.77	\$ 67.48
	50%	\$ 21.47	\$ 40.50	\$ 59.52	\$ 78.53	\$ 97.54
	55%	\$ 33.47	\$ 59.60	\$ 85.72	\$ 111.84	\$ 137.95
	60%	\$ 49.53	\$ 85.10	\$ 120.66	\$ 156.22	\$ 191.77

Lesson 6: Don't forget to mop up...

- Watch out for “other” equity claims: If you buy equity in a young, growth company, watch out for other (often hidden) claims on the equity that don't take the form of common shares. In particular, watch for options granted to managers, employees, venture capitalists and others (you will be surprised...).
 - ▣ Value these options as options (not at exercise value)
 - ▣ Take into consideration expectations of future option grants when computing expected future earnings/cash flows.
- Not all shares are equal: If there are differences in cash flow claims (dividends or liquidation) or voting rights across shares, value these differences.
 - ▣ Voting rights matter even at well run companies

Lesson 7: You will be wrong 100% of the time... and it really is not (always) your fault...

- No matter how careful you are in getting your inputs and how well structured your model is, your estimate of value will change both as new information comes out about the company, the business and the economy.
- As information comes out, you will have to adjust and adapt your model to reflect the information. Rather than be defensive about the resulting changes in value, recognize that this is the essence of risk.
- A test: If your valuations are unbiased, you should find yourself increasing estimated values as often as you are decreasing values. In other words, there should be equal doses of good and bad news affecting valuations (at least over time).

And the market is often “more wrong”

Amazon: Value and Price

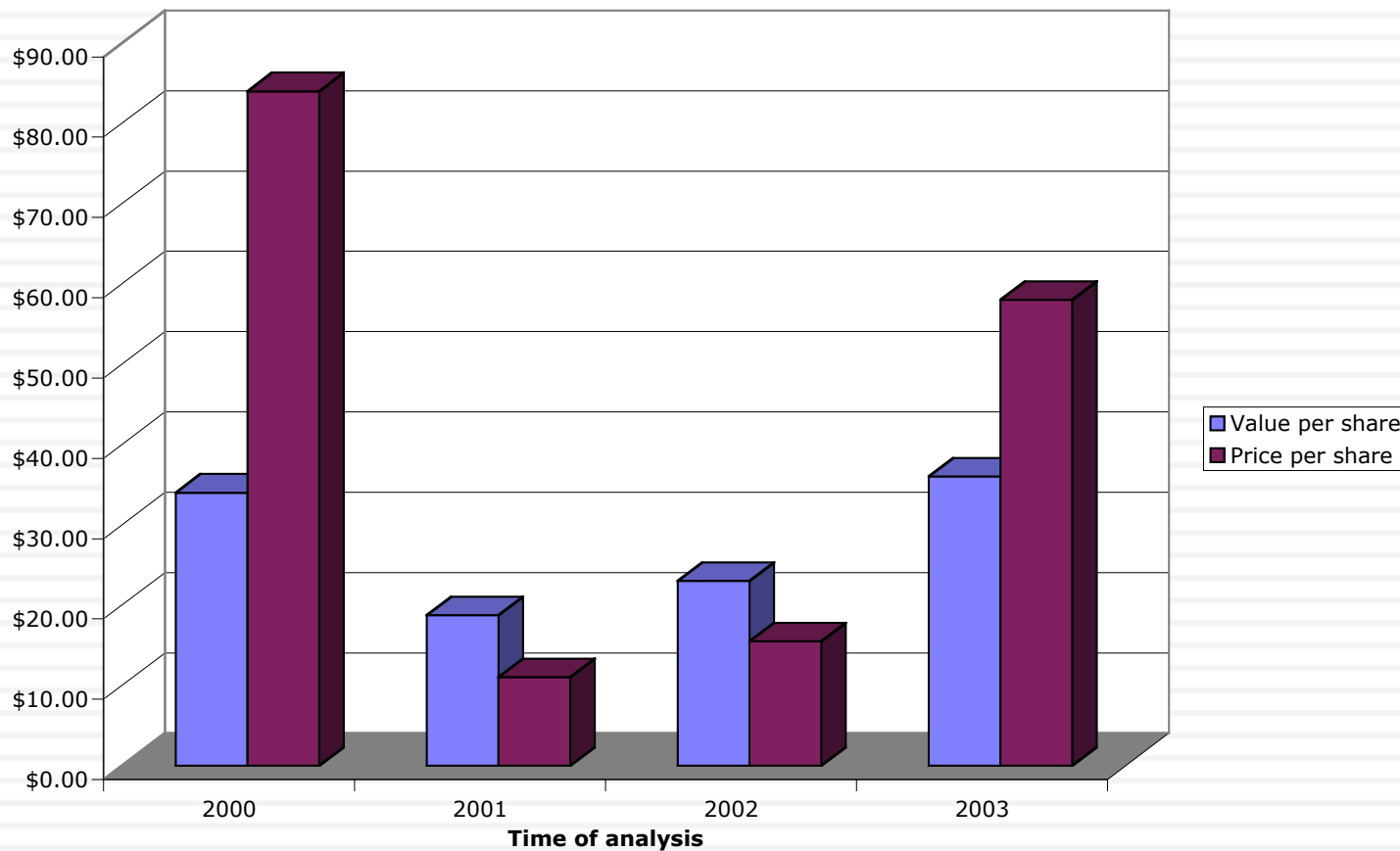

Valuing an IPO

□ Valuation issues:

- Use of the proceeds from the offering: The proceeds from the offering can be held as cash by the firm to cover future investment needs, paid to existing equity investors who want to cash out or used to pay down debt.
- Warrants/ Special deals with prior equity investors: If venture capitalists and other equity investors from earlier iterations of fund raising have rights to buy or sell their equity at pre-specified prices, it can affect the value per share offered to the public.

□ Pricing issues:

- Institutional set-up: Most IPOs are backed by investment banking guarantees on the price, which can affect how they are priced.
- Follow-up offerings: The proportion of equity being offered at initial offering and subsequent offering plans can affect pricing.

Alibaba: Pre-IPO valuation - September 2, 2014 (in US \$)

	T12M	2012-13
Revenues	\$9,268	\$4,821
Operating Income	\$4,702	\$1,777
Effective tax rate	11.92%	
Operating Margin	50.73%	

Revenue growth of 25% a year for 5 years, tapering down to 2.63% in year 10

Pre-tax operating margin decreases to 40% over time & tax rate rises to 25%

Sales to capital ratio maintained at 2.00

Stable Growth
 $g = 2.41\%$
 Cost of capital = 8%
 ROC = 8%;
 Reinvestment Rate = $2.41\%/8\% = 30.125\%$

Terminal Value₁₀ = $10,353 / (.08 - 0.0241) = \$185,198$

	1	2	3	4	5	6	7	8	9	10
Revenue growth rate	25.00%	25.00%	25.00%	25.00%	25.00%	20.48%	15.96%	11.45%	6.93%	2.41%
Revenues	\$ 11,585	\$ 14,481	\$ 18,101	\$ 22,626	\$ 28,283	\$ 34,075	\$ 39,515	\$ 44,038	\$ 47,089	\$ 48,224
EBIT (Operating) margin	49.66%	48.59%	47.51%	46.44%	45.37%	44.29%	43.22%	42.15%	41.07%	40.00%
EBIT (Operating income)	\$ 5,753	\$ 7,035	\$ 8,600	\$ 10,507	\$ 12,831	\$ 15,093	\$ 17,078	\$ 18,560	\$ 19,341	\$ 19,290
Tax rate	11.92%	11.92%	11.92%	11.92%	11.92%	14.54%	17.15%	19.77%	22.38%	25.00%
EBIT(1-t)	\$ 5,067	\$ 6,197	\$ 7,575	\$ 9,255	\$ 11,301	\$ 12,899	\$ 14,149	\$ 14,891	\$ 15,012	\$ 14,467
- Reinvestment	\$ 1,158	\$ 1,448	\$ 1,810	\$ 2,263	\$ 2,828	\$ 2,896	\$ 2,720	\$ 2,261	\$ 1,525	\$ 567
FCFF	\$ 3,908	\$ 4,749	\$ 5,765	\$ 6,992	\$ 8,473	\$ 10,002	\$ 11,429	\$ 12,630	\$ 13,486	\$ 13,900

Term yr	
EBIT (1-t)	\$14,816
- Reinv	4,463
FCFF	10,353

Operating assets	\$137,386
+ Cash	9330
- Debt	10068
+ Equity investments	2,087
+ Alipay provision	3,000
+ IPO Proceeds (est)	20,000
- Options	696
Value of equity	161,039
Value per share	\$65.98

Cost of capital = $8.90\% (.943) + 3.00\% (.057) = 8.56\%$

Cost of capital decreases to 8% from years 6-10

Cost of Equity
8.90%

Cost of Debt
 $4\% (1 - .25) = 3.00\%$

Weights
E = 94.3% D = 5.7%

Riskfree Rate:
Riskfree rate = 2.41%

Beta
1.092

Unlevered Beta: 1.044
(70% advertising, 30% online retailing)

D/E = 6.07%

ERP
5.94%

China	90.29%	5.90%
Global	9.71%	6.35%
Alibaba	100.00%	5.94%

Two days after this valuation, the company (and its bankers) valued itself at about \$155 billion and the shares at \$63 apiece. The offering price was raised to \$69 and the opening price was \$93/share.

II. Mature Companies in transition..

- Mature companies are generally the easiest group to value. They have long, established histories that can be mined for inputs. They have investment policies that are set and capital structures that are stable, thus making valuation more grounded in past data.
- However, this stability in the numbers can mask real problems at the company. The company may be set in a process, where it invests more or less than it should and does not have the right financing mix. In effect, the policies are consistent, stable and bad.
- If you expect these companies to change or as is more often the case to have change thrust upon them,

The perils of valuing mature companies...

Figure 7.1: Estimation Issues - Mature Companies

Lots of historical data on earnings and cashflows. Key questions remain if these numbers are volatile over time or if the existing assets are not being efficiently utilized.

Growth is usually not very high, but firms may still be generating healthy returns on investments, relative to cost of funding. Questions include how long they can generate these excess returns and with what growth rate in operations. Restructuring can change both inputs dramatically and some firms maintain high growth through acquisitions.

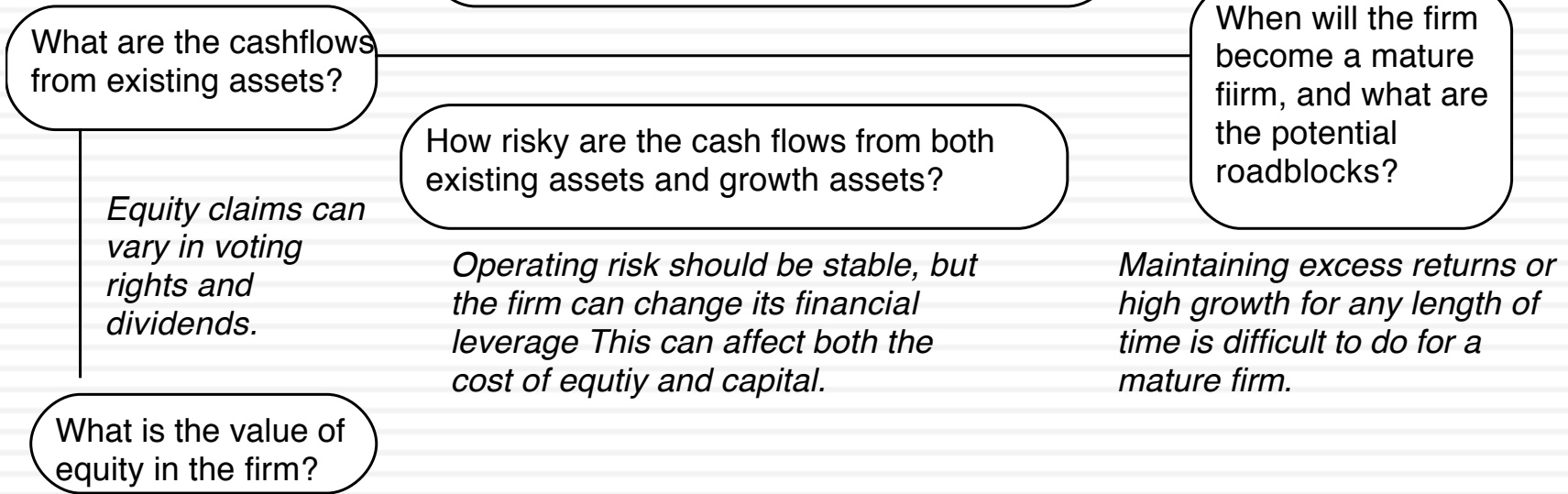

Hormel Foods: The Value of Control Changing

Hormel Foods sells packaged meat and other food products and has been in existence as a publicly traded company for almost 80 years. In 2008, the firm reported after-tax operating income of \$315 million, reflecting a compounded growth of 5% over the previous 5 years.

The Status Quo

Run by existing management, with conservative reinvestment policies (reinvestment rate = 14.34% and debt ratio = 10.4%.

Anemic growth rate and short growth period, due to reinvestment policy

Low debt ratio affects cost of capital

Year	Operating income after taxes	Expected growth rate	ROC	Reinvestment Rate	Reinvestment	FCFF	Cost of capital	Present Value
Trailing 12 months	\$315							
1	\$324	2.75%	14.34%	19.14%	\$62	\$262	6.79%	\$245
2	\$333	2.75%	14.34%	19.14%	\$64	\$269	6.79%	\$236
3	\$342	2.75%	14.34%	19.14%	\$65	\$276	6.79%	\$227
Beyond	\$350	2.35%	7.23%	32.52%	\$114	\$4,840	7.23%	\$3,974
Value of operating assets								\$4,682
(Add) Cash								\$155
(Subtract) Debt								\$491
(Subtract) Management Options								\$53
Value of equity in common stock								\$4,293
Value per share								\$31.91

New and better management

More aggressive reinvestment which increases the reinvestment rate (to 40%) and tlength of growth (to 5 years), and higher debt ratio (20%).

Operating Restructuring (1)

Expected growth rate = $ROC \times \text{Reinvestment Rate}$
 Expected growth rate (status quo) = $14.34\% \times 19.14\% = 2.75\%$
 Expected growth rate (optimal) = $14.00\% \times 40\% = 5.60\%$
 ROC drops, reinvestment rises and growth goes up.

Financial restructuring (2)

Cost of capital = Cost of equity (1-Debt ratio) + Cost of debt (Debt ratio)
 Status quo = $7.33\% (1-.104) + 3.60\% (.104) = 6.79\%$
 Optimal = $7.75\% (1-.20) + 3.60\% (.20) = 6.63\%$
 Cost of equity rises but cost of capital drops.

Year	Operating income after taxes	Expected growth rate	ROC	Reinvestment Rate	Reinvestment	FCFF	Cost of capital	Present Value
Trailing 12 months	\$315							
1	\$333	5.60%	14.00%	40.00%	\$133	\$200	6.63%	\$187
2	\$351	5.60%	14.00%	40.00%	\$141	\$211	6.63%	\$185
3	\$371	5.60%	14.00%	40.00%	\$148	\$223	6.63%	\$184
4	\$392	5.60%	14.00%	40.00%	\$260	\$235	6.63%	\$182
5	\$414	5.60%	14.00%	40.00%	\$223	\$248	6.63%	\$180
Beyond	\$423	2.35%	6.74%	34.87%	\$148	\$6,282	6.74%	\$4,557
Value of operating assets								\$5,475
(Add) Cash								\$155
(Subtract) Debt								\$491
(Subtract) Management Options								\$53
Value of equity in common stock								\$5,085
Value per share								\$37.80

Aswath Damodaran

Probability of management change = 10%
 Expected value = $\$31.91 (.90) + \$37.80 (.10) = \$32.50$

(3)

(4)

Lesson 1: Cost cutting and increased efficiency are easier accomplished on paper than in practice...

Cost-synergy estimation is better, but there are patterns emerging in the errors

Mergers achieving stated percentage of expected cost savings, percent $N = 92$

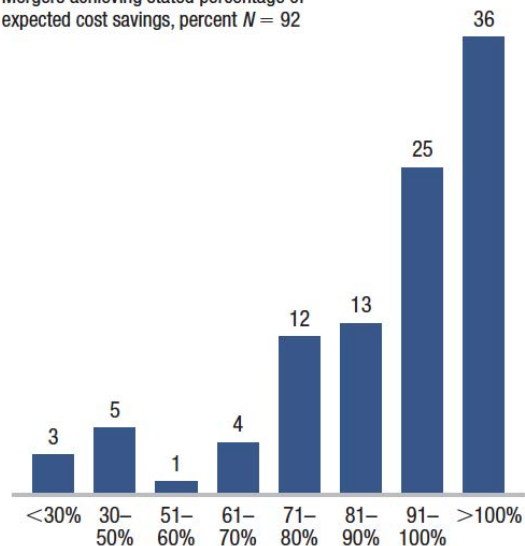

Typical sources of estimation error

- Underestimating one-time costs
- Using benchmarks from noncomparable situations
- Not sanity-checking management estimates against precedent transactions
- Failing to ground estimates in bottom-up analysis (e.g., location-by-location review of overlaps)

Source: McKinsey (2002) Postmerger Management Practice client survey; client case studies

Lesson 2: Increasing growth is not always an option (or at least not a good option)

Modes of organic growth vary in value creation intensity—consumer goods industry

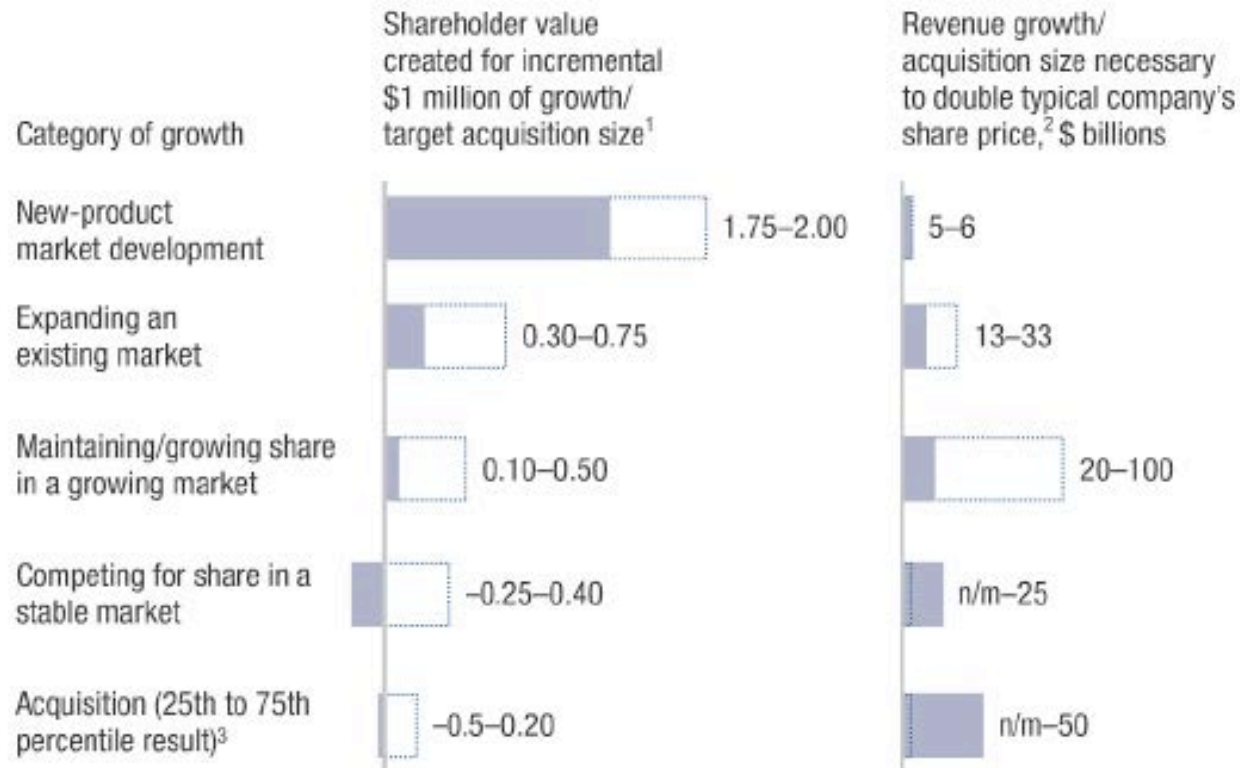

Lesson 3: Financial leverage is a double-edged sword..

Exhibit 7.1: Optimal Financing Mix: Hormel Foods in January 2009

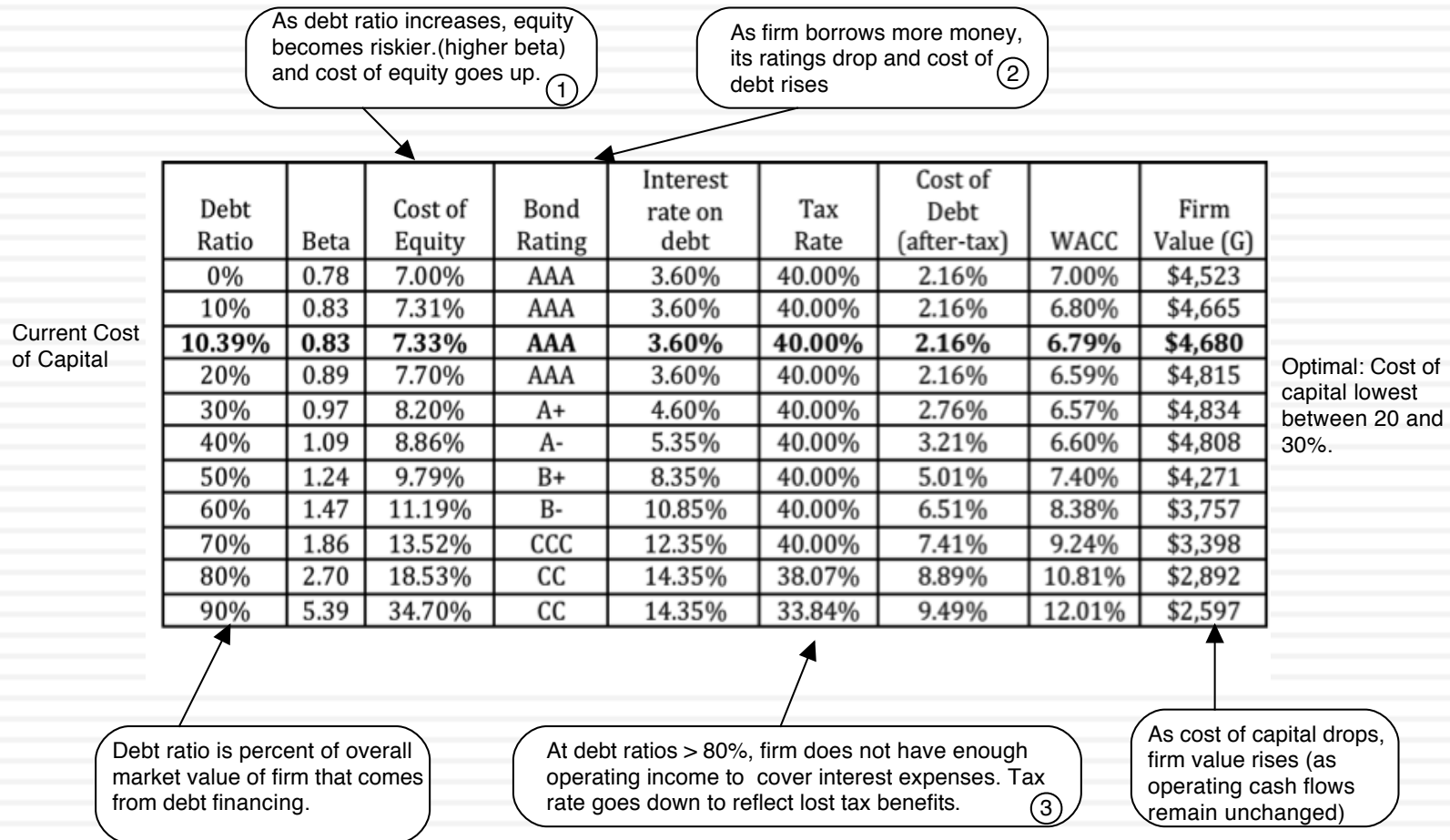

III. Dealing with decline and distress...

Historical data often reflects flat or declining revenues and falling margins. Investments often earn less than the cost of capital.

Growth can be negative, as firm sheds assets and shrinks. As less profitable assets are shed, the firm's remaining assets may improve in quality.

What is the value added by growth assets?

What are the cashflows from existing assets?

Underfunded pension obligations and litigation claims can lower value of equity. Liquidation preferences can affect value of equity

What is the value of equity in the firm?

How risky are the cash flows from both existing assets and growth assets?

Depending upon the risk of the assets being divested and the use of the proceeds from the divestiture (to pay dividends or retire debt), the risk in both the firm and its equity can change.

When will the firm become a mature firm, and what are the potential roadblocks?

There is a real chance, especially with high financial leverage, that the firm will not make it. If it is expected to survive as a going concern, it will be as a much smaller entity.

Dealing with the “downside” of Distress

- A DCF valuation values a firm as a going concern. If there is a significant likelihood of the firm failing before it reaches stable growth and if the assets will then be sold for a value less than the present value of the expected cashflows (a distress sale value), DCF valuations will understate the value of the firm.
- Value of Equity= DCF value of equity (1 - Probability of distress) + Distress sale value of equity (Probability of distress)
- There are three ways in which we can estimate the probability of distress:
 - Use the bond rating to estimate the cumulative probability of distress over 10 years
 - Estimate the probability of distress with a probit
 - Estimate the probability of distress by looking at market value of bonds..
- The distress sale value of equity is usually best estimated as a percent of book value (and this value will be lower if the economy is doing badly and there are other firms in the same business also in distress).

Current Revenue
\$ 4,390

Current Margin:
4.76%

Reinvestment:
Capital expenditures include cost of new casinos and working capital

Stable Growth
Stable Revenue Growth: 3%
Stable Operating Margin: 17%
Stable ROC=10% Reinvest 30% of EBIT(1-t)

EBIT
\$ 209m

Extended reinvestment break, due ot investment in past

Industry average

Expected Margin:
-> 17%

Terminal Value= $758 \cdot (.0743 \cdot .03)$
=\$ 17,129

Revenues	\$4,434	\$4,523	\$5,427	\$6,513	\$7,815	\$8,206	\$8,616	\$9,047	\$9,499	\$9,974	Term. Year \$10,273
Oper margin	5.81%	6.86%	7.90%	8.95%	10%	11.40%	12.80%	14.20%	15.60%	17%	17%
EBIT	\$258	\$310	\$429	\$583	\$782	\$935	\$1,103	\$1,285	\$1,482	\$1,696	\$ 1,746
Tax rate	26.0%	26.0%	26.0%	26.0%	26.0%	28.4%	30.8%	33.2%	35.6%	38.00%	38%
EBIT * (1 - t)	\$191	\$229	\$317	\$431	\$578	\$670	\$763	\$858	\$954	\$1,051	\$1,083
- Reinvestment	-\$19	-\$11	\$0	\$22	\$58	\$67	\$153	\$215	\$286	\$350	\$ 325
FCFF	\$210	\$241	\$317	\$410	\$520	\$603	\$611	\$644	\$668	\$701	\$758
		1	2	3	4	5	6	7	8	9	10
Beta		3.14	3.14	3.14	3.14	3.14	2.75	2.36	1.97	1.59	1.20
Cost of equity		21.82%	21.82%	21.82%	21.82%	21.82%	19.50%	17.17%	14.85%	12.52%	10.20%
Cost of debt		9%	9%	9%	9%	9%	8.70%	8.40%	8.10%	7.80%	7.50%
Debt/ratio		73.50%	73.50%	73.50%	73.50%	73.50%	68.80%	64.10%	59.40%	54.70%	50.00%
Cost of capital		9.88%	9.88%	9.88%	9.88%	9.88%	9.79%	9.50%	9.01%	8.32%	7.43%

Term. Year
\$10,273
17%
\$ 1,746
38%
\$1,083
\$ 325
\$758

Forever

Value of Op Assets \$ 9,793
+ Cash & Non-op \$ 3,040
= Value of Firm \$12,833
- Value of Debt \$ 7,565
= Value of Equity \$ 5,268

Value per share \$ 8.12

Cost of Equity
21.82%

Cost of Debt
 $3\% + 6\% = 9\%$
 $9\% (1 - .38) = 5.58\%$

Weights
Debt= 73.5% ->50%

Riskfree Rate:
T. Bond rate = 3%

+ **Beta**
3.14 -> 1.20

Risk Premium
6%

Casino
1.15

Current
D/E: 277%

Base Equity
Premium

Country Risk
Premium

Las Vegas Sands
Feburary 2009
Trading @ \$4.25

Aswath Damodaran

Adjusting the value of LVS for distress..

- In February 2009, LVS was rated B+ by S&P. Historically, 28.25% of B+ rated bonds default within 10 years. LVS has a 6.375% bond, maturing in February 2015 (7 years), trading at \$529. If we discount the expected cash flows on the bond at the riskfree rate, we can back out the probability of distress from the bond price:

$$529 = \sum_{t=1}^{t=7} \frac{63.75(1 - \Pi_{\text{Distress}})^t}{(1.03)^t} + \frac{1000(1 - \Pi_{\text{Distress}})^7}{(1.03)^7}$$

- Solving for the probability of bankruptcy, we get:
- π_{Distress} = Annual probability of default = 13.54%
 - Cumulative probability of surviving 10 years = $(1 - .1354)^{10} = 23.34\%$
 - Cumulative probability of distress over 10 years = $1 - .2334 = .7666$ or 76.66%
- If LVS is becomes distressed:
 - Expected distress sale proceeds = \$2,769 million < Face value of debt
 - Expected equity value/share = \$0.00
- Expected value per share = $\$8.12 (1 - .7666) + \$0.00 (.7666) = \$1.92$

The “sunny” side of distress: Equity as a call option to liquidate the firm

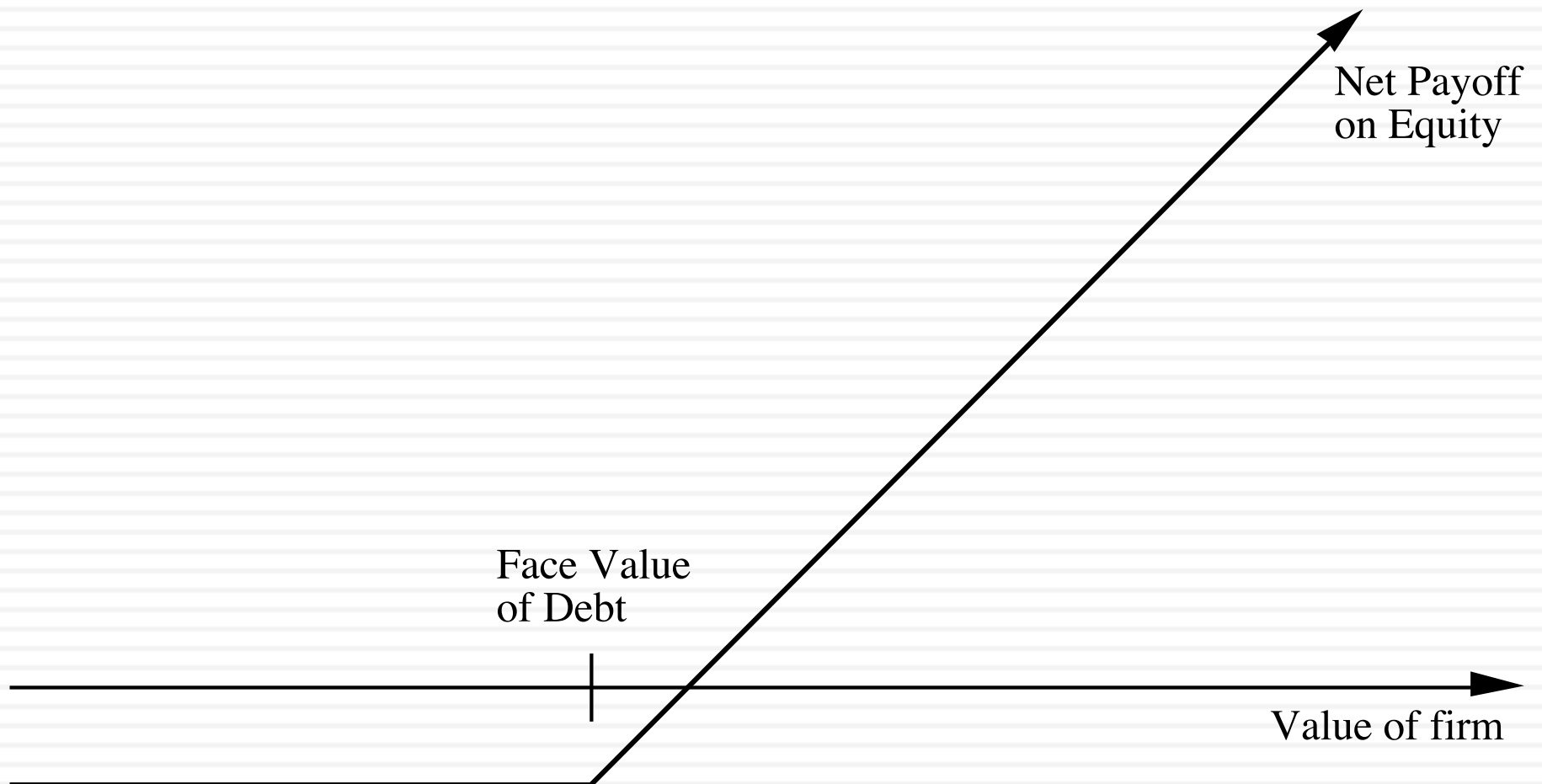

Application to valuation: A simple example

- Assume that you have a firm whose assets are currently valued at \$100 million and that the standard deviation in this asset value is 40%.
- Further, assume that the face value of debt is \$80 million (It is zero coupon debt with 10 years left to maturity).
- If the ten-year treasury bond rate is 10%,
 - ▣ how much is the equity worth?
 - ▣ What should the interest rate on debt be?

Equity value persists .. As firm value declines..

Value of Equity as Firm Value Changes

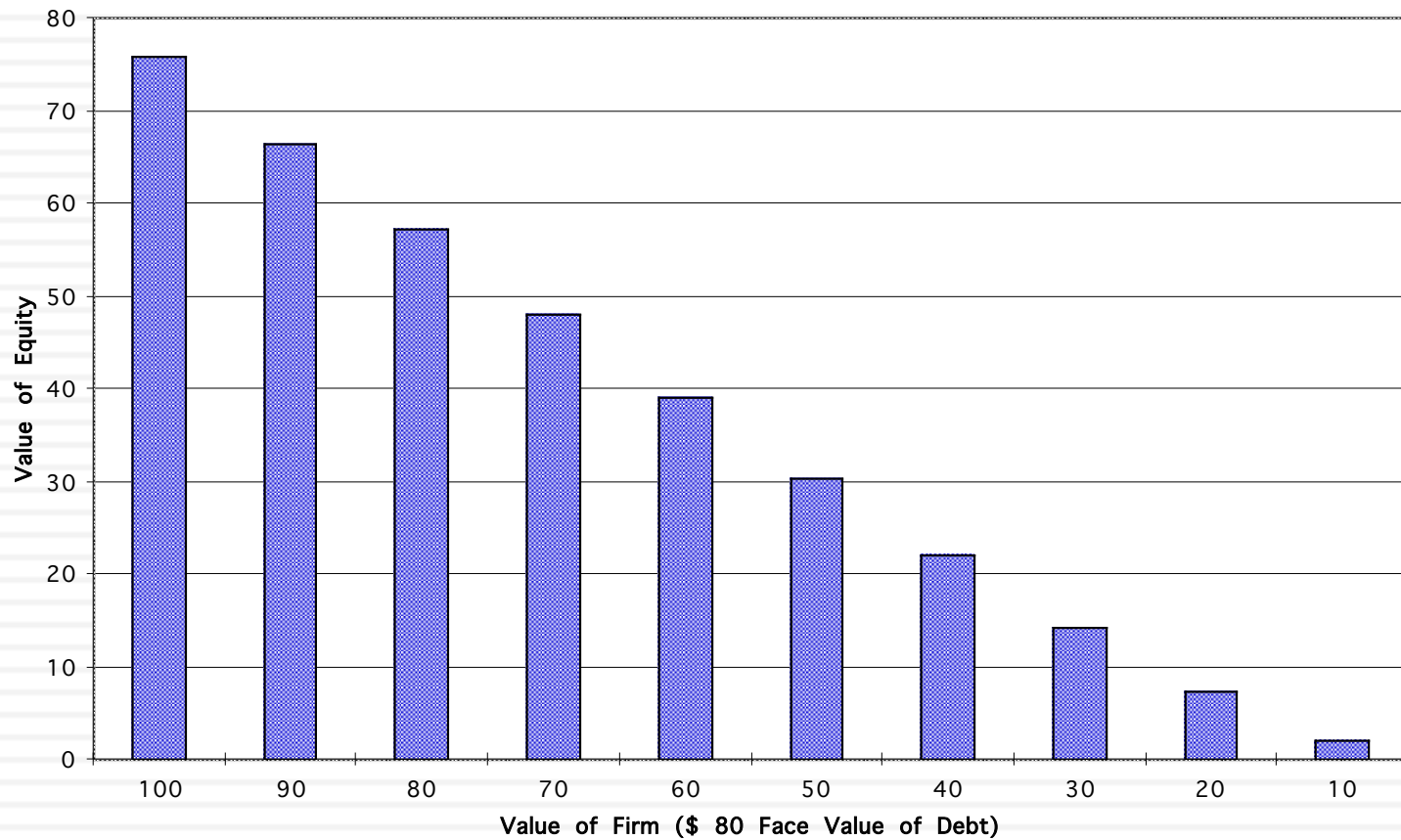

IV. Valuing Financial Service Companies

Existing assets are usually financial assets or loans, often marked to market. Earnings do not provide much information on underlying risk.

Defining capital expenditures and working capital is a challenge. Growth can be strongly influenced by regulatory limits and constraints. Both the amount of new investments and the returns on these investments can change with regulatory changes.

What is the value added by growth assets?

What are the cashflows from existing assets?

When will the firm become a mature firm, and what are the potential roadblocks?

Preferred stock is a significant source of capital.

How risky are the cash flows from both existing assets and growth assets?

What is the value of equity in the firm?

For financial service firms, debt is raw material rather than a source of capital. It is not only tough to define but if defined broadly can result in high financial leverage, magnifying the impact of small operating risk changes on equity risk.

In addition to all the normal constraints, financial service firms also have to worry about maintaining capital ratios that are acceptable to regulators. If they do not, they can be taken over and shut down.

CIB Egypt in December 2015

Valuation in Egyptian Pounds

ROE = 42.48%

Retention Ratio = 75.25%

Dividends
 EPS = 4.04 EGP
 * Payout Ratio 24.75%
 DPS = 1.00 EGP

Expected Growth
 75.25% *
 42.48% = 31.96%

g = 10%: ROE = 25% (= Cost of equity)
 Beta = 0.81
 Payout = (1 - 10/25) = .60

	1	2	3	4	5	6	7	8	9	10
Expected Growth Rate	31.96%	31.96%	31.96%	31.96%	31.96%	27.57%	23.18%	18.79%	14.39%	10.00%
Earnings per share	5.33 ج.م	7.04 ج.م	9.28 ج.م	12.25 ج.م	16.17 ج.م	20.63 ج.م	25.41 ج.م	30.18 ج.م	34.52 ج.م	37.97 ج.م
Payout ratio	24.75%	24.75%	24.75%	24.75%	24.75%	31.80%	38.85%	45.90%	52.95%	60.00%
Dividends per share	1.32 ج.م	1.74 ج.م	2.30 ج.م	3.03 ج.م	4.00 ج.م	6.56 ج.م	9.87 ج.م	13.85 ج.م	18.28 ج.م	22.78 ج.م
Cost of Equity	23.25%	23.25%	23.25%	23.25%	23.25%	23.25%	23.25%	23.25%	23.25%	23.25%
Cumulative Cost of Equity	123.25%	151.90%	187.21%	230.73%	284.37%	350.48%	431.95%	532.37%	656.13%	808.66%
Present Value	1.07 ج.م	1.15 ج.م	1.23 ج.م	1.31 ج.م	1.41 ج.م	1.87 ج.م	2.29 ج.م	2.60 ج.م	2.79 ج.م	2.82 ج.م

Terminal Value
 = $EPS_6 * Payout / (r - g)$
 = $(37.97 * .6) / (.2325 - .10) = 189.20$

Value of Equity per share = PV of Dividends & Terminal value = 41.93 EGP

Discount at Cost of Equity

Forever

Cost of Equity
 $10.53\% + 0.81 (15.70\%) = 23.25\%$

In December 2015, CIB was trading at 36 EGP per share

Riskfree Rate:
 In EGP
 10.53%

US \$ risk free rate (2.27%)
 adjusted for diff inflation
 $(1.0227) * (1.097 / 1.015) - 1$

+

0.81

x

Equity Risk Premium
 15.7%

Average Beta for Banks

100% in Egypt

Lesson 1: Financial service companies are opaque...

- With financial service firms, we enter into a Faustian bargain. They tell us very little about the quality of their assets (loans, for a bank, for instance are not broken down by default risk status) but we accept that in return for assets being marked to market (by accountants who presumably have access to the information that we don't have).
- In addition, estimating cash flows for a financial service firm is difficult to do. So, we trust financial service firms to pay out their cash flows as dividends. Hence, the use of the dividend discount model.

Lesson 2: For financial service companies, book value matters...

- The book value of assets and equity is mostly irrelevant when valuing non-financial service companies. After all, the book value of equity is a historical figure and can be nonsensical. (The book value of equity can be negative and is so for more than a 1000 publicly traded US companies)
- With financial service firms, book value of equity is relevant for two reasons:
 - Since financial service firms mark to market, the book value is more likely to reflect what the firms own right now (rather than a historical value)
 - The regulatory capital ratios are based on book equity. Thus, a bank with negative or even low book equity will be shut down by the regulators.
- From a valuation perspective, it therefore makes sense to pay heed to book value. In fact, you can argue that reinvestment for a bank is the amount that it needs to add to book equity to sustain its growth ambitions and safety requirements:
 - $FCFE = \text{Net Income} - \text{Reinvestment in regulatory capital (book equity)}$

Deutsche Bank: A Crisis Valuation (October 2016)

Risk adjusted assets grows at inflation rate of 1% a year forever.

Tier 1 capital ratio increases to 15.67%, the 75th percentile for all banks

Expected DOJ fine of \$10 billions lower Tier 1 capital today

Common Equity increases in tandem with Tier 1 capital

Cost of equity starts at 10.2% (75th percentile of banks) & decreases after year 5 to 9.44% (median across banks).

	Current	1	2	3	4	5	6	7	8	9	10
Risk Adjusted Assets	\$ 445,570	\$ 450,026	\$ 454,526	\$ 459,071	\$ 463,662	\$ 468,299	\$ 472,982	\$ 477,711	\$ 482,488	\$ 487,313	\$ 492,186
Tier 1 Capital Ratio	12.41%	13.74%	13.95%	14.17%	14.38%	14.60%	14.81%	15.03%	15.24%	15.46%	15.67%
Tier 1 Capital (Risk Adjusted Assets * Tier 1 Capital Ratio)	\$55,282	\$61,834	\$63,427	\$65,045	\$66,690	\$68,361	\$70,059	\$71,784	\$73,537	\$75,317	\$77,126
Change in regulatory capital (Tier 1)		\$6,552	\$1,593	\$1,619	\$1,645	\$1,671	\$1,698	\$1,725	\$1,753	\$1,780	\$1,809
Book Equity	\$64,609	\$71,161	\$72,754	\$74,372	\$76,017	\$77,688	\$79,386	\$81,111	\$82,864	\$84,644	\$86,453
Expected ROE	-13.70%	-7.18%	-2.84%	0.06%	1.99%	5.85%	6.568%	7.286%	8.004%	8.722%	9.440%
Net Income (Book Equity * ROE)	\$ (8,851)	\$ (5,111)	\$ (2,065)	\$ 43	\$ 1,512	\$ 4,545	\$ 5,214	\$ 5,910	\$ 6,632	\$ 7,383	\$ 8,161
- Investment in Regulatory Capital		\$ 6,552	\$ 1,593	\$ 1,619	\$ 1,645	\$ 1,671	\$ 1,698	\$ 1,725	\$ 1,753	\$ 1,780	\$ 1,809
FCFE		\$ (11,663)	\$ (3,658)	\$ (1,576)	\$ (133)	\$ 2,874	\$ 3,516	\$ 4,185	\$ 4,880	\$ 5,602	\$ 6,352
Terminal value of equity											\$87,317
Present value		\$ (10,583)	\$ (3,012)	\$ (1,178)	\$ (90)	\$ 1,768	\$ 1,966	\$ 2,129	\$ 2,262	\$ 2,370	\$ 36,207
Cost of equity	10.20%	10.20%	10.20%	10.20%	10.20%	10.20%	10.048%	9.896%	9.744%	9.592%	9.440%
Cumulative Cost of equity		1.1020	1.2144	1.3383	1.4748	1.6252	1.7885	1.9655	2.1570	2.3639	2.5871
Value of equity today =	\$31,838.74										
Number of shares outstanding =	1386.00										
DCF Value per share =	\$ 22.97										
Probability of equity wipeout	10.00%										
Adjusted value per share =	\$ 20.67										
Stock price on October 3, 2016 =	\$ 13.33										

Value per share adjusted for probability of catastrophic failure (bailout) resulting in complete loss of equity.

Return on equity increases to 5.85% (25th percentile of banks) in year 5 and 9.44% (cost of equity) in year 10

V. Valuing cyclical and commodity companies

Company growth often comes from movements in the economic cycle, for cyclical firms, or commodity prices, for commodity companies.

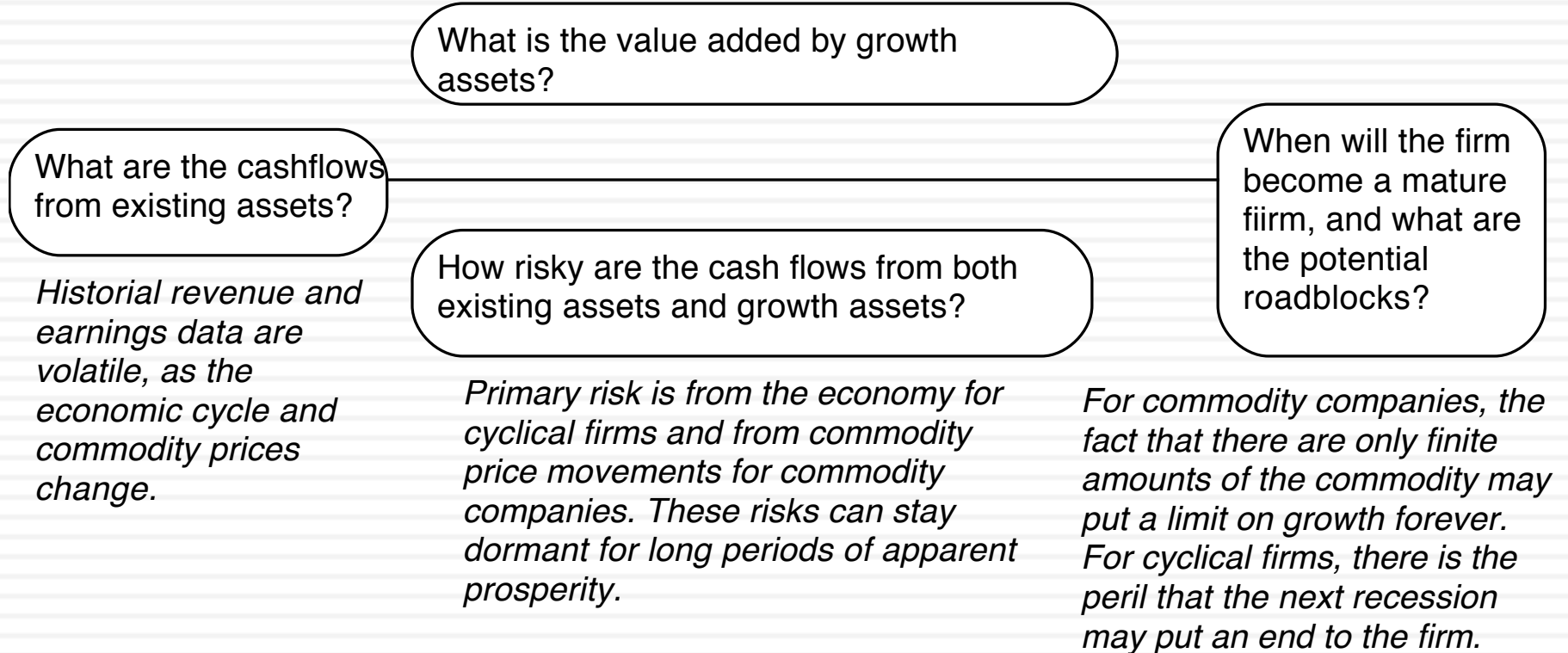

Valuing a Cyclical Company - Toyota in Early 2009

In early 2009, Toyota Motors had the highest market share in the sector. However, the global economic recession in 2008-09 had pulled earnings down.

Year	Revenues	Operating Inco	EBITDA	Operating Marg
FY1 1992	¥10,163,380	¥218,511	¥218,511	2.15%
FY1 1993	¥10,210,750	¥181,897	¥181,897	1.78%
FY1 1994	¥9,362,732	¥136,226	¥136,226	1.45%
FY1 1995	¥8,120,975	¥255,719	¥255,719	3.15%
FY1 1996	¥10,718,740	¥348,069	¥348,069	3.25%
FY1 1997	¥12,243,830	¥665,110	¥665,110	5.43%
FY1 1998	¥11,678,400	¥779,800	¥1,382,950	6.68%
FY1 1999	¥12,749,010	¥774,947	¥1,415,997	6.08%
FY1 2000	¥12,879,560	¥775,982	¥1,430,982	6.02%
FY1 2001	¥13,424,420	¥870,131	¥1,542,631	6.48%
FY1 2002	¥15,106,300	¥1,123,475	¥1,822,975	7.44%
FY1 2003	¥16,054,290	¥1,363,680	¥2,101,780	8.49%
FY1 2004	¥17,294,760	¥1,666,894	¥2,454,994	9.64%
FY1 2005	¥18,551,530	¥1,672,187	¥2,447,987	9.01%
FY1 2006	¥21,036,910	¥1,878,342	¥2,769,742	8.93%
FY1 2007	¥23,948,090	¥2,238,683	¥3,185,683	9.35%
FY1 2008	¥26,289,240	¥2,270,375	¥3,312,775	8.64%
FY 2009 (Estin	¥22,661,325	¥267,904	¥1,310,304	1.18%
		¥1,306,867		7.33%

Normalized Earnings ①

As a cyclical company, Toyota's earnings have been volatile and 2009 earnings reflect the troubled global economy. We will assume that when economic growth returns, the operating margin for Toyota will revert back to the historical average.

Normalized Operating Income = Revenues in 2009 * Average Operating Margin (98--09)
 = 22661 * .0733 = 1660.7 billion yen

Normalized Return on capital and Reinvestment ②

Once earnings bounce back to normal, we assume that Toyota will be able to earn a return on capital equal to its cost of capital (5.09%). This is a sector, where earning excess returns has proved to be difficult even for the best of firms.

To sustain a 1.5% growth rate, the reinvestment rate has to be:
 Reinvestment rate = 1.5%/5.09%
 = 29.46%

Operating Assets	19,640
+ Cash	2,288
+ Non-operating assets	6,845
- Debt	11,862
- Minority Interests	583
Value of Equity	
/ No of shares	/3,448
Value per share	¥4735

$$\text{Value of operating assets} = \frac{1660.7 (1.015) (1 - .407) (1 - .2946)}{(.0509 - .015)} = 19,640 \text{ billion}$$

Normalized Cost of capital ③

The cost of capital is computed using the average beta of automobile companies (1.10), and Toyota's cost of debt (3.25%) and debt ratio (52.9% debt ratio. We use the Japanese marginal tax rate of 40.7% for computing both the after-tax cost of debt and the after-tax operating income

Cost of capital = 8.65% (.471) + 3.25% (1-.407) (.529) = 5.09%

Aswath Damodaran

Stable Growth ④

Once earnings are normalized, we assume that Toyota, as the largest market-share company, will be able to maintain only stable growth (1.5% in Yen terms)

Lesson 1: With “macro” companies, it is easy to get lost in “macro” assumptions...

- With cyclical and commodity companies, it is undeniable that the value you arrive at will be affected by your views on the economy or the price of the commodity.
- Consequently, you will feel the urge to take a stand on these macro variables and build them into your valuation. Doing so, though, will create valuations that are jointly impacted by your views on macro variables and your views on the company, and it is difficult to separate the two.
- The best (though not easiest) thing to do is to separate your macro views from your micro views. Use current market based numbers for your valuation, but then provide a separate assessment of what you think about those market numbers.

Shell's Revenues & Oil Prices

Shell: Revenues vs Oil Price

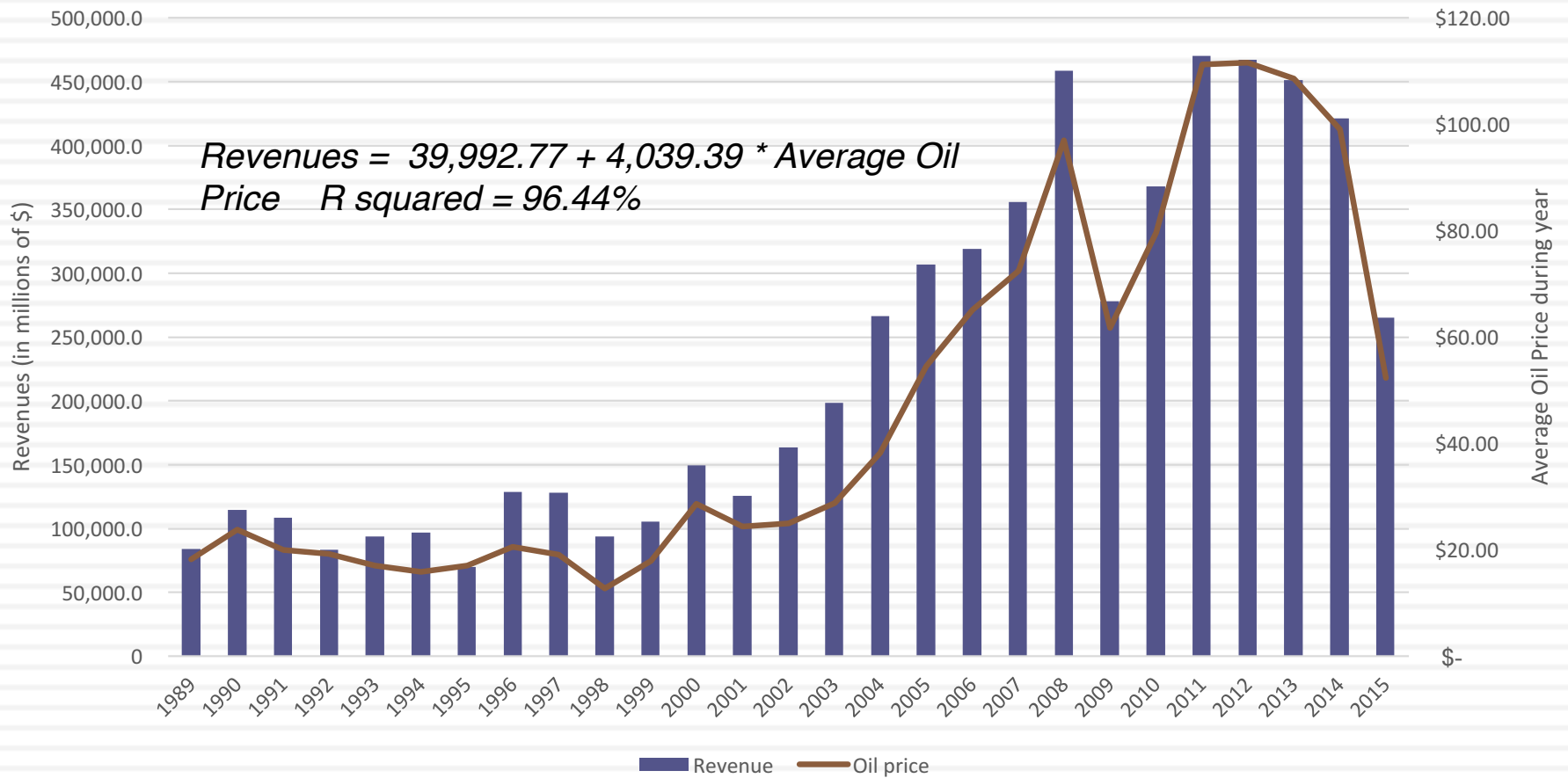

Shell: A "Oil Price" Neutral Valuation: March 2016

Revenue calculated from prevailing oil price of \$40/barrel in March 2016
 Revenue = 39992.77+4039.40*\$40
 = \$201,569

Compounded revenue growth of 3.91% a year, based on Shell's historical revenue growth rate from 2000 to 2015

	Base Year	1	2	3	4	5	Terminal Year
Revenues	\$ 201,569	\$ 209,450	\$ 217,639	\$ 226,149	\$ 234,991	\$ 244,180	\$ 249,063
Operating Margin	3.01%	6.18%	7.76%	8.56%	8.95%	9.35%	9.35%
Operating Income	\$ 6,065.00	\$ 12,942.85	\$ 16,899.10	\$ 19,352.39	\$ 21,040.39	\$ 22,830.80	\$ 23,287.41
Effective tax rate	30.00%	30.00%	30.00%	30.00%	30.00%	30.00%	30.00%
AT Operating Income	\$ 4,245.50	\$ 9,060.00	\$ 11,829.37	\$ 13,546.68	\$ 14,728.27	\$ 15,981.56	\$ 16,301.19
+ Depreciation	\$ 26,714.00	\$ 27,759	\$ 28,844	\$ 29,972	\$ 31,144	\$ 32,361	
- Cap Ex	\$ 31,854.00	\$ 33,099	\$ 34,394	\$ 35,738	\$ 37,136	\$ 38,588	
- Chg in WC		\$ 472.88	\$ 491.37	\$ 510.58	\$ 530.55	\$ 551.29	
FCFF		\$ 3,246.14	\$ 5,788.19	\$ 7,269.29	\$ 8,205.44	\$ 9,203.68	\$ 13,011.34
Terminal Value						\$ 216,855.71	
Return on capital							12.37%
Cost of Capital		9.91%	9.91%	9.91%	9.91%	9.91%	8.00%
Cumulated Discount Factor		1.0991	1.2080	1.3277	1.4593	1.6039	
Present Value		\$ 2,953.45	\$ 4,791.47	\$ 5,474.95	\$ 5,622.81	\$ 140,940.73	
Value of Operating Assets	\$ 159,783.41						
+ Cash	\$ 31,752.00						
+ Cross Holdings	\$ 33,566.00						
- Debt	\$ 58,379.00						
- Minority Interests	\$ 1,245.00						
Value of Equity	\$ 165,477.41						
Number of shares	4209.7						
Value per share	\$ 39.31						

Operating margin converges on Shell's historical average margin of 9.35% from 200-2015

Return on capital reverts and stays at Shell's historic average of 12.37% from 200-2015

Added long term investments in joint ventures and subtracted out minority interest in consolidated holdings.

Lesson 2: Use probabilistic tools to assess value as a function of macro variables...

- If there is a key macro variable affecting the value of your company that you are uncertain about (and who is not), why not quantify the uncertainty in a distribution (rather than a single price) and use that distribution in your valuation.
- That is exactly what you do in a Monte Carlo simulation, where you allow one or more variables to be distributions and compute a distribution of values for the company.
- With a simulation, you get not only everything you would get in a standard valuation (an estimated value for your company) but you will get additional output (on the variation in that value and the likelihood that your firm is under or over valued)

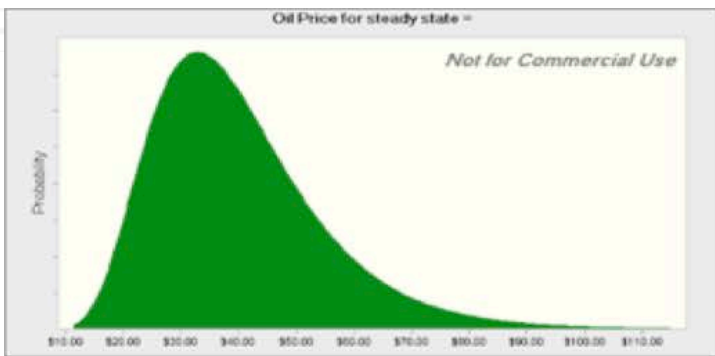

Revenue calculated from the oil price drawn from distribution
 $Revenue = 39992.77 + 4039.40 * \text{Oil Price/Barrel}$

Pre-tax Operating Income based on revenue & selected margin
 $Pre\text{-tax Operating Income} = Revenues * Operating\ Margin$



Value Shell based on operating income, assuming other assumptions (tax rate, revenue growth, cost of capital)

Percentiles:	Forecast values
0%	\$6.55
10%	\$23.90
20%	\$27.73
30%	\$30.89
40%	\$33.88
50%	\$36.99
60%	\$40.28
70%	\$44.22
80%	\$49.24
90%	\$57.49
100%	\$197.11

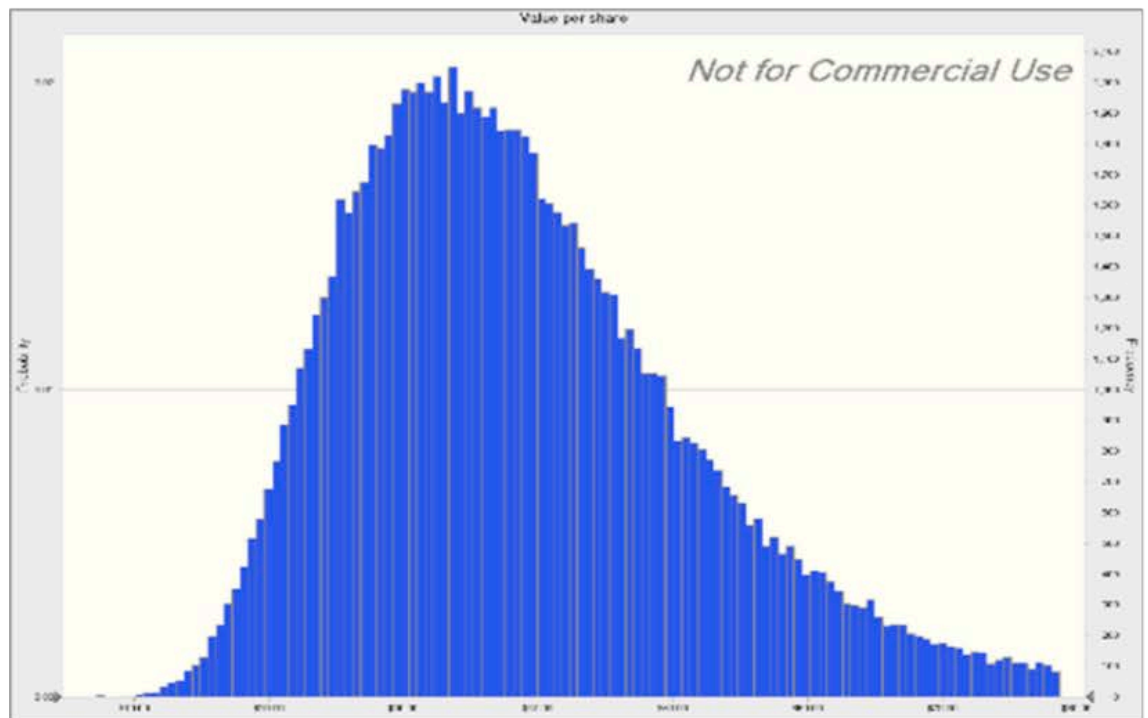

The optionality in commodities: Undeveloped reserves as an option

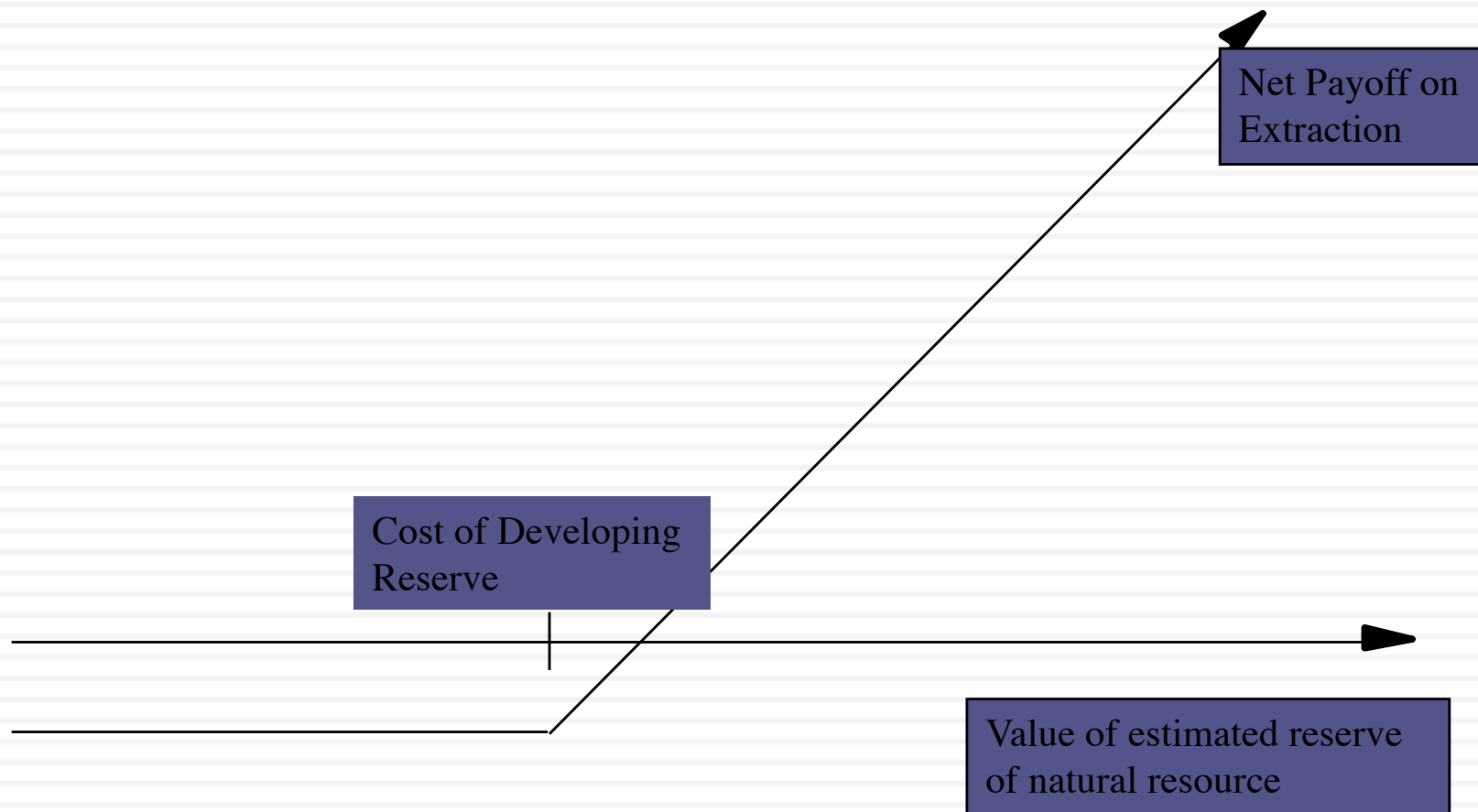

Valuing Gulf Oil

- Gulf Oil was the target of a takeover in early 1984 at \$70 per share (It had 165.30 million shares outstanding, and total debt of \$9.9 billion).
 - It had estimated reserves of 3038 million barrels of oil and the average cost of developing these reserves was estimated to be \$10 a barrel in present value dollars (The development lag is approximately two years).
 - The average relinquishment life of the reserves is 12 years.
 - The price of oil was \$22.38 per barrel, and the production cost, taxes and royalties were estimated at \$7 per barrel.
 - The bond rate at the time of the analysis was 9.00%.
 - Gulf was expected to have net production revenues each year of approximately 5% of the value of the developed reserves. The variance in oil prices is 0.03.

Valuing Undeveloped Reserves

- Inputs for valuing undeveloped reserves
 - ▣ Value of underlying asset = Value of estimated reserves discounted back for period of development lag = $3038 * (\$ 22.38 - \$7) / 1.05^2 = \$42,380.44$
 - ▣ Exercise price = Estimated development cost of reserves = $3038 * \$10 = \$30,380$ million
 - ▣ Time to expiration = Average length of relinquishment option = 12 years
 - ▣ Variance in value of asset = Variance in oil prices = 0.03
 - ▣ Riskless interest rate = 9%
 - ▣ Dividend yield = Net production revenue/ Value of developed reserves = 5%
- Based upon these inputs, the Black-Scholes model provides the following value for the call:
 - ▣ $d1 = 1.6548$ $N(d1) = 0.9510$
 - ▣ $d2 = 1.0548$ $N(d2) = 0.8542$
- Call Value = $42,380.44 \exp^{(-0.05)(12)} (0.9510) - 30,380 (\exp^{(-0.09)(12)} (0.8542)) = \$ 13,306$ million

The composite value...

- In addition, Gulf Oil had free cashflows to the firm from its oil and gas production of \$915 million from already developed reserves and these cashflows are likely to continue for ten years (the remaining lifetime of developed reserves).
- The present value of these developed reserves, discounted at the weighted average cost of capital of 12.5%, yields:
 - ▣ Value of already developed reserves = $915 (1 - 1.125^{-10}) / .125 = \5065.83
- Adding the value of the developed and undeveloped reserves
 - ▣ Value of undeveloped reserves = \$ 13,306 million
 - ▣ Value of production in place = \$ 5,066 million
 - ▣ Total value of firm = \$ 18,372 million
 - ▣ Less Outstanding Debt = \$ 9,900 million
 - ▣ Value of Equity = \$ 8,472 million
 - ▣ Value per share = \$ 8,472 / 165.3 = \$51.25

VII. Valuing Companies across the ownership cycle

Reported income and balance sheet are heavily affected by tax considerations rather than information disclosure requirements. The line between the personal and business expenses is a fine one.

What are the **cashflows from existing assets**?
- Equity: Cashflows after debt payments
- Firm: Cashflows before debt payments

Reversing investment mistakes is difficult to do. The need for and the cost of illiquidity has to be incorporated into current value.

What is the **value added** by growth assets?
Equity: Growth in equity earnings/ cashflows
Firm: Growth in operating earnings/ cashflows

How **risky** are the **cash flows** from both existing assets and growth assets?
Equity: Risk in equity in the company
Firm: Risk in the firm's operations

Different buyers can perceive risk differently in the same private business, largely because what they see as risk will be a function of how diversified they are. The fall back positions of using market prices to extract risk measures does not work.

When will the firm become a **mature firm**, and what are the potential roadblocks?

Many private businesses are finite life enterprises, not expected to last into perpetuity

Kristin's Kandy: Valuation in March 2006

Current Cashflow to Firm
 EBIT(1-t) : 300
 - Nt CpX 100
 - Chg WC 40
 = FCFF 160
 Reinvestment Rate = 46.67%

Reinvestment Rate
 46.67%

Expected Growth in EBIT (1-t)
 $.4667 \times .1364 = .0636$
6.36%

Return on Capital
 13.64%

Stable Growth
 $g = 4\%$; Beta = 3.00;
 ROC = 12.54%
 Reinvestment Rate = 31.90%

Terminal Value₅ = $289 / (.1254 - .04) = 3,403$

Firm Value: 2,571
 + Cash 125
 - Debt: 900
 = Equity 1,796
 - Illiq Discount 12.5%
 Adj Value 1,571

Year	1	2	3	4	5	Term Yr
EBIT (1-t)	\$319	\$339	\$361	\$384	\$408	425
- Reinvestment	\$149	\$158	\$168	\$179	\$191	136
=FCFF	\$170	\$181	\$193	\$205	\$218	289

Discount at Cost of Capital (WACC) = $16.26\% (.70) + 3.30\% (.30) = 12.37\%$

Cost of Equity
16.26%

Cost of Debt
 $(4.5\% + 1.00)(1 - .40) = 3.30\%$
 Synthetic rating = A-

Weights
 E = 70% D = 30%

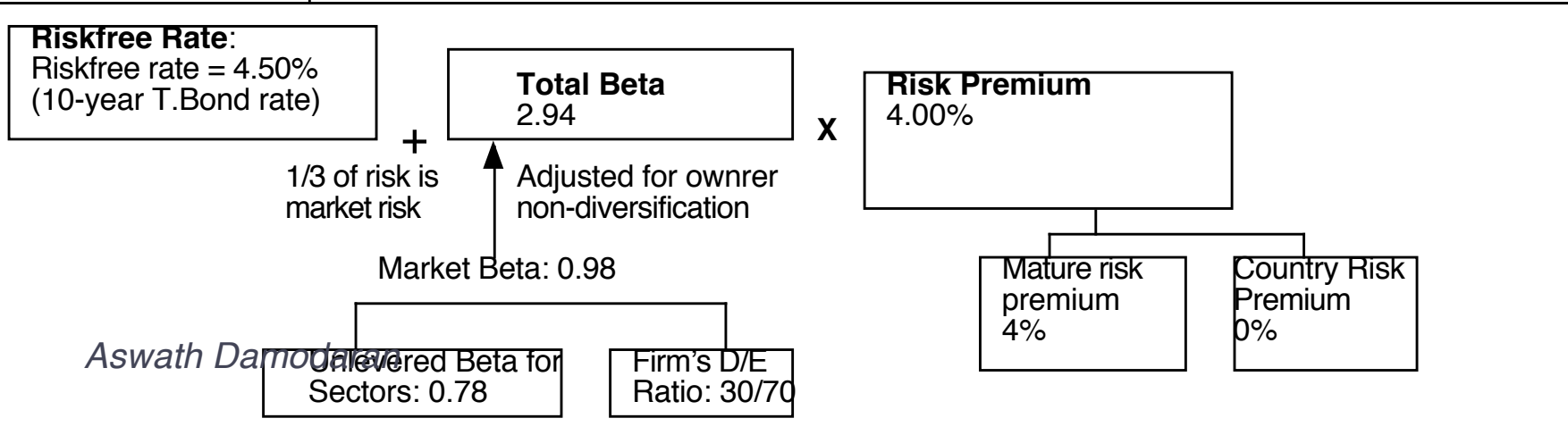

Lesson 1: In private businesses, risk in the eyes of the “beholder” (buyer)

Private business owner with entire wealth invested in the business

Venture capitalist, with multiple holdings in the sector.

Public company investor with diversified portfolio

Exposed to all risk in the company. Total beta measures exposure to total risk. Total Beta = Market Beta/ Correlation of firm with market

Partially diversified. Diversify away some firm specific risk but not all. Beta will fall between total and market beta.

Firm-specific risk is diversified away. Market or macro risk exposure captured in a market beta or betas.

Private Owner versus Publicly Traded Company Perceptions of Risk in an Investment

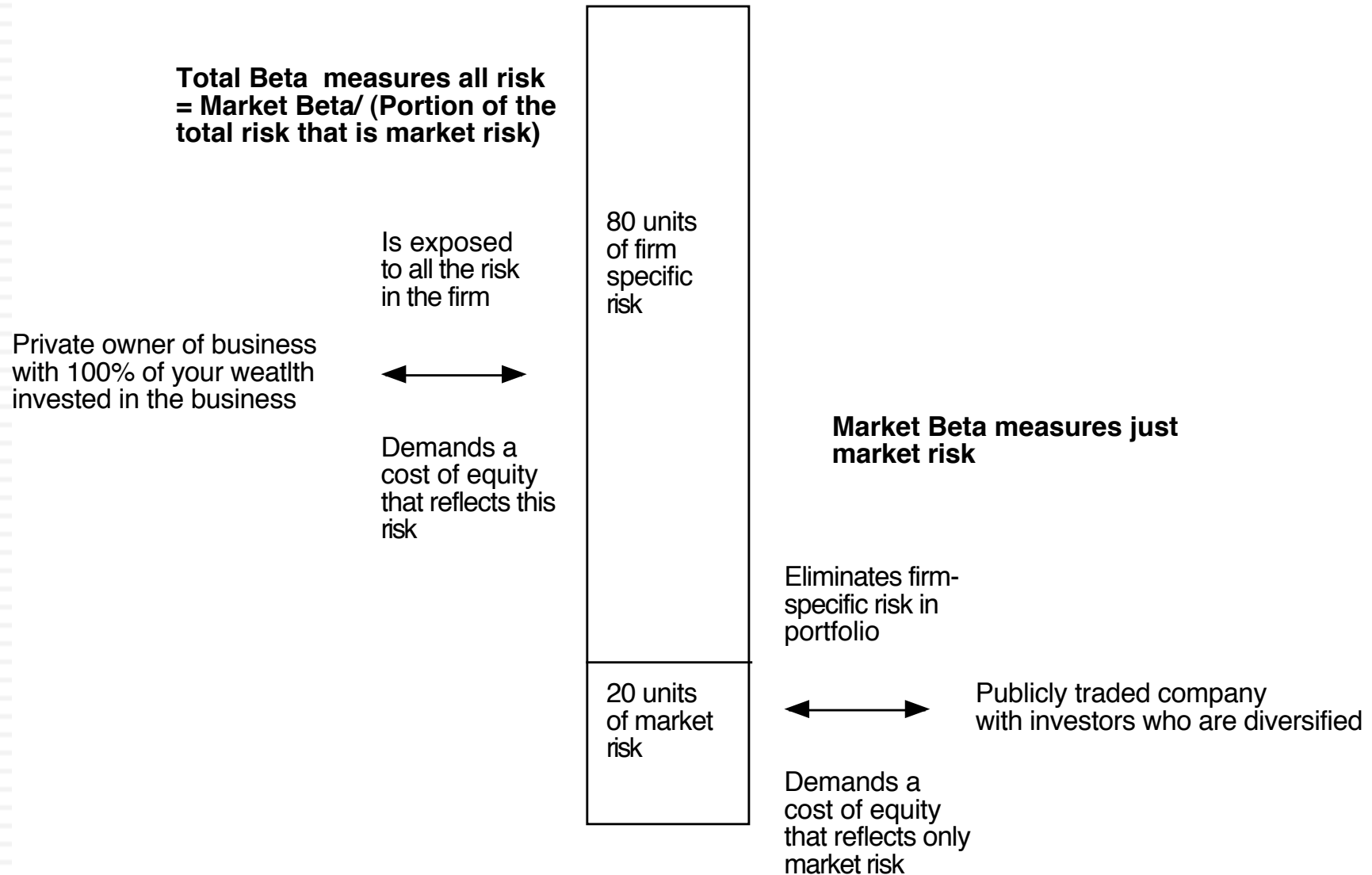

Total Risk versus Market Risk

- Adjust the beta to reflect total risk rather than market risk. This adjustment is a relatively simple one, since the R squared of the regression measures the proportion of the risk that is market risk.
 - Total Beta = Market Beta / Correlation of the sector with the market
- To estimate the beta for Kristin Kandy, we begin with the bottom-up unlevered beta of food processing companies:
 - Unlevered beta for publicly traded food processing companies = 0.78
 - Average correlation of food processing companies with market = 0.333
 - Unlevered total beta for Kristin Kandy = $0.78/0.333 = 2.34$
 - Debt to equity ratio for Kristin Kandy = $0.3/0.7$ (assumed industry average)
 - Total Beta = $2.34 (1 - (1-.40)(30/70)) = 2.94$
 - Total Cost of Equity = $4.50\% + 2.94 (4\%) = 16.26\%$

Lesson 2: With financials, trust but verify..

- Different Accounting Standards: The accounting statements for private firms are often based upon different accounting standards than public firms, which operate under much tighter constraints on what to report and when to report.
- Intermingling of personal and business expenses: In the case of private firms, some personal expenses may be reported as business expenses.
- Separating “Salaries” from “Dividends”: It is difficult to tell where salaries end and dividends begin in a private firm, since they both end up with the owner.
- The Key Person issue: In some private businesses, with a personal component, the cashflows may be intertwined with the owner being part of the business.

Lesson 3: Illiquidity is a clear and present danger..

- In private company valuation, illiquidity is a constant theme. All the talk, though, seems to lead to a rule of thumb. The illiquidity discount for a private firm is between 20-30% and does not vary across private firms.
- But illiquidity should vary across:
 - Companies: Healthier and larger companies, with more liquid assets, should have smaller discounts than money-losing smaller businesses with more illiquid assets.
 - Time: Liquidity is worth more when the economy is doing badly and credit is tough to come by than when markets are booming.
 - Buyers: Liquidity is worth more to buyers who have shorter time horizons and greater cash needs than for longer term investors who don't need the cash and are willing to hold the investment.

And it is not just in private businesses..

- Almarai is a publicly traded company with 600 million shares outstanding but only 175 million of these shares are traded (float). One reason is that Almarai, like most Middle Eastern companies, is controlled by family holdings (Savola Group and Al Saud Sultan Mohamed).
- In addition, the Saudi market is not a very liquid market, with little trading volume and not much non-Saudi investor interests in Saudi stocks.
- Will the lack of liquidity affect your valuation of Almarai?
 - a. Yes
 - b. No



NARRATIVE AND NUMBERS:
VALUATION AS A BRIDGE



Valuation as a bridge

Number Crunchers

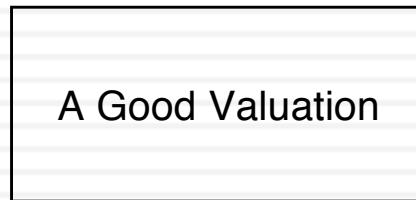
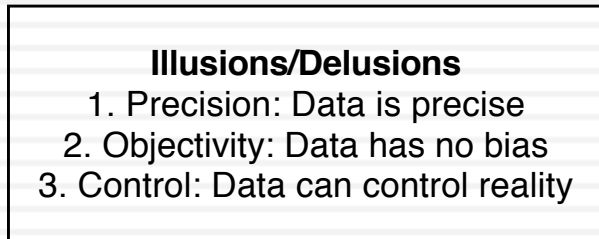
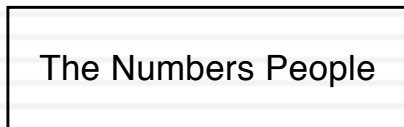
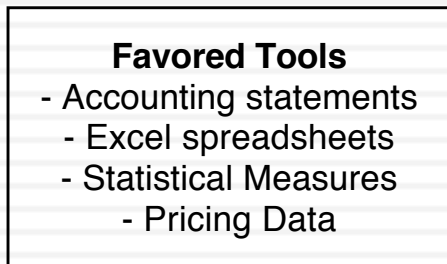

Story Tellers

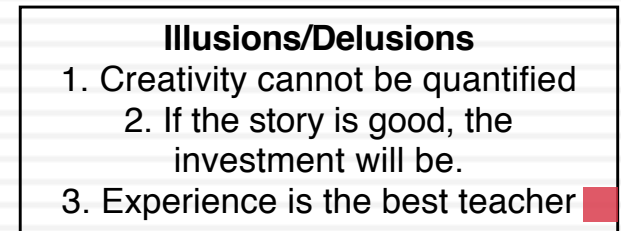
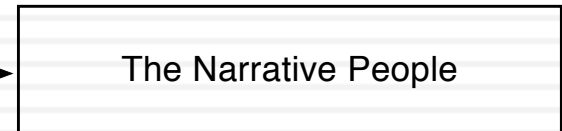
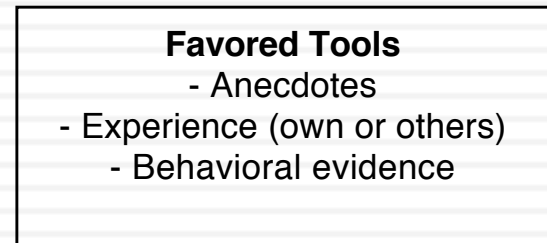

Step 1: Survey the landscape

- Every valuation starts with a narrative, a story that you see unfolding for your company in the future.
- In developing this narrative, you will be making assessments of
 - ▣ Your company (its products, its management and its history).
 - ▣ The market or markets that you see it growing in.
 - ▣ The competition it faces and will face.
 - ▣ The macro environment in which it operates.

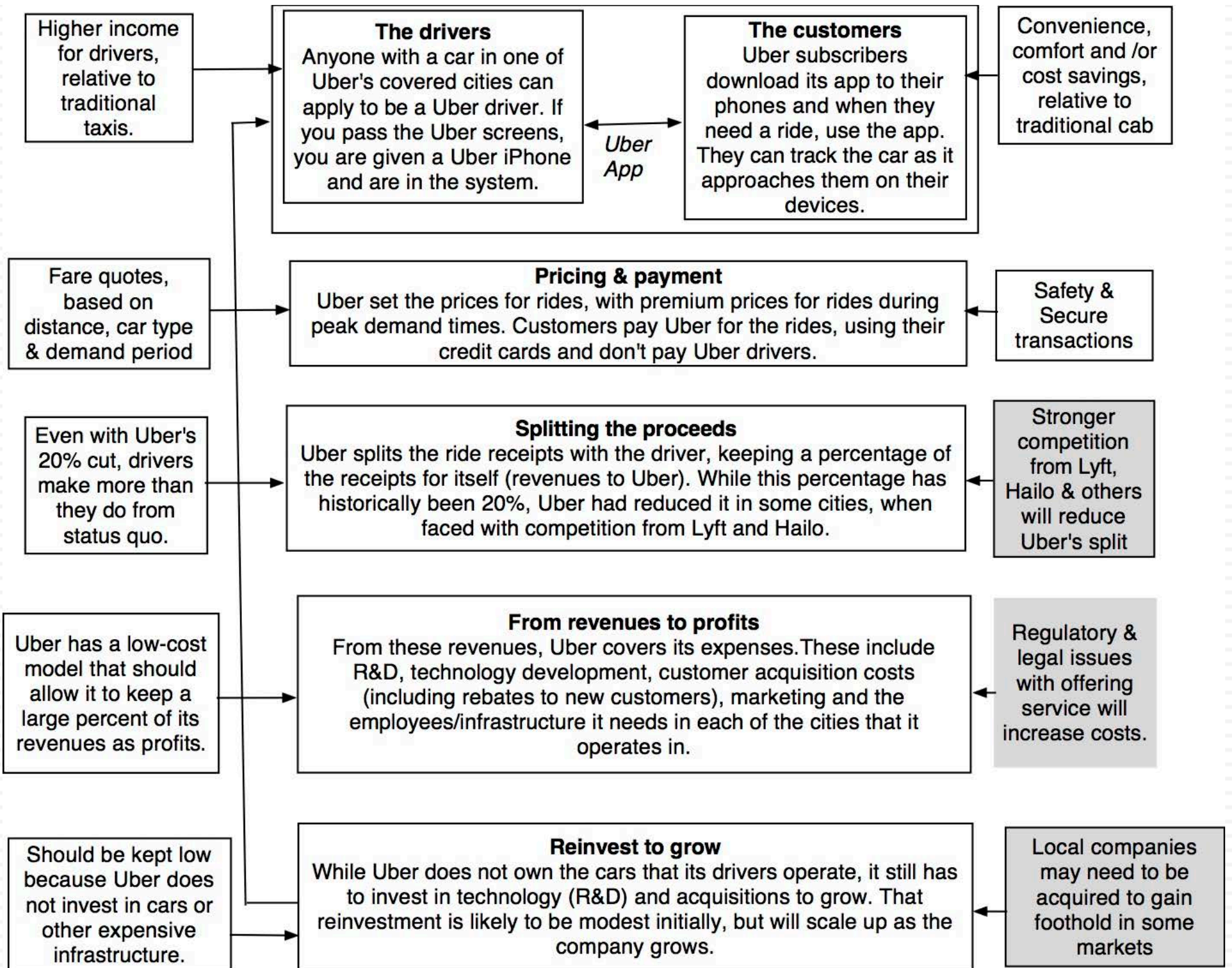

Low Growth

The Auto Business

Low Margins

Year	Revenues (\$)	% Growth Rate
2005	1,274,716.60	
2006	1,421,804.20	11.54%
2007	1,854,576.40	30.44%
2008	1,818,533.00	-1.94%
2009	1,572,890.10	-13.51%
2010	1,816,269.40	15.47%
2011	1,962,630.40	8.06%
2012	2,110,572.20	7.54%
2013	2,158,603.00	2.28%
2014	2,086,124.80	-3.36%
Rounded Average =		5.63%

+

The Automobile Business: Pre-tax Operating Margins in 2015

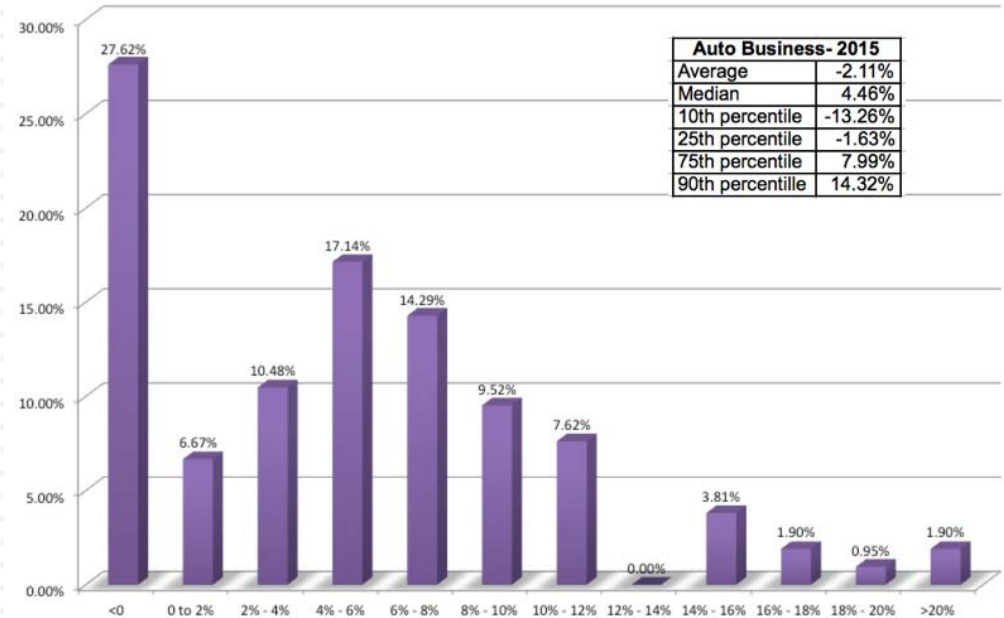

Auto Business-2015	
Average	-2.11%
Median	4.46%
10th percentile	-13.26%
25th percentile	-1.63%
75th percentile	7.99%
90th percentile	14.32%

High & Increasing Reinvestment

Bad Business

The Reinvestment Burden: Investment as % of Sales for Auto Business

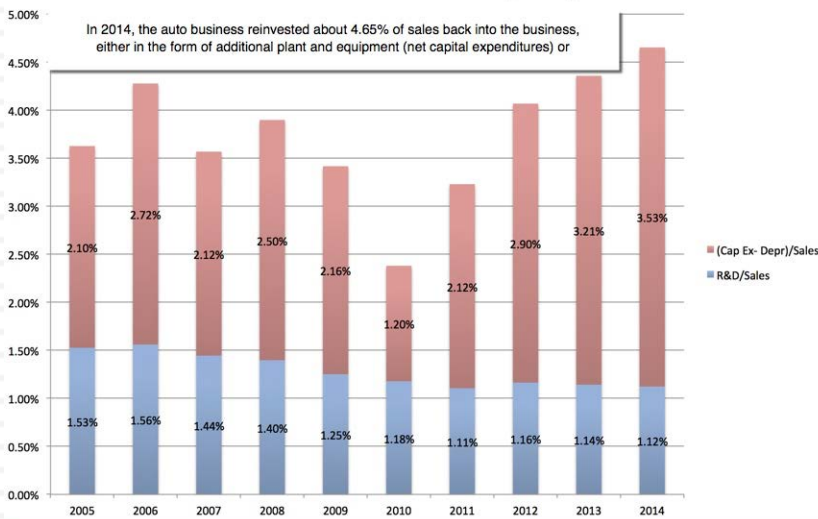

=

	ROIC	Cost of capital	ROIC - Cost of capital
2004	6.82%	7.93%	-1.11%
2005	10.47%	7.02%	3.45%
2006	4.60%	7.97%	-3.37%
2007	7.62%	8.50%	-0.88%
2008	3.48%	8.03%	-4.55%
2009	-4.97%	8.58%	-13.55%
2010	5.16%	8.03%	-2.87%
2011	7.55%	8.15%	-0.60%
2012	7.80%	8.55%	-0.75%
2013	7.83%	8.47%	-0.64%
2014	6.47%	7.53%	-1.06%

Only once in the last 10 years have auto companies collectively earned more than their cost of capital

What makes Ferrari different?

Ferrari sold only 7,255 cars in all of 2014

Ferrari had a profit margin of 18.2%, in the 95th percentile, partly because of its high prices and partly because it spends little on advertising.

Ferrari: Geographical Sales (2014)

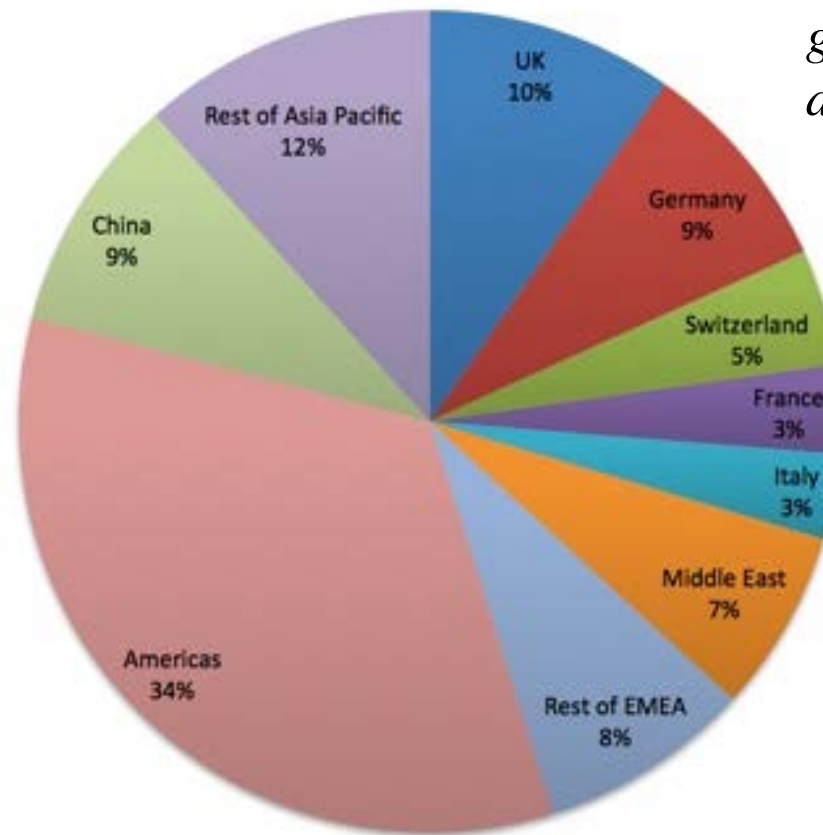

Ferrari sales (in units) have grown very little in the last decade & have been stable

Ferrari has not invested in new plants.

Step 2: Create a narrative for the future

- Every valuation starts with a narrative, a story that you see unfolding for your company in the future.
- In developing this narrative, you will be making assessments of your company (its products, its management), the market or markets that you see it growing in, the competition it faces and will face and the macro environment in which it operates.
 - ▣ Rule 1: Keep it simple.
 - ▣ Rule 2: Keep it focused.

The Uber Narrative

In June 2014, my initial narrative for Uber was that it would be

1. An urban car service business: I saw Uber primarily as a force in urban areas and only in the car service business.
2. Which would expand the business moderately (about 40% over ten years) by bringing in new users.
3. With local networking benefits: If Uber becomes large enough in any city, it will quickly become larger, but that will be of little help when it enters a new city.
4. Maintain its revenue sharing (20%) system due to strong competitive advantages (from being a first mover).
5. And its existing low-capital business model, with drivers as contractors and very little investment in infrastructure.

The Ferrari Narrative

- Ferrari will stay an exclusive auto club, deriving its allure from its scarcity and the fact that only a few own Ferraris.
- By staying exclusive, the company gets three benefits:
 - ▣ It can continue to charge nose bleed prices for its cars and sell them with little or no advertising.
 - ▣ It does not need to invest in new assembly plants, since it does not plan to ramp up production.
 - ▣ It sells only to the super rich, who are unaffected by overall economic conditions or market crises.

Step 3: Check the narrative against history, economic first principles & common sense

150

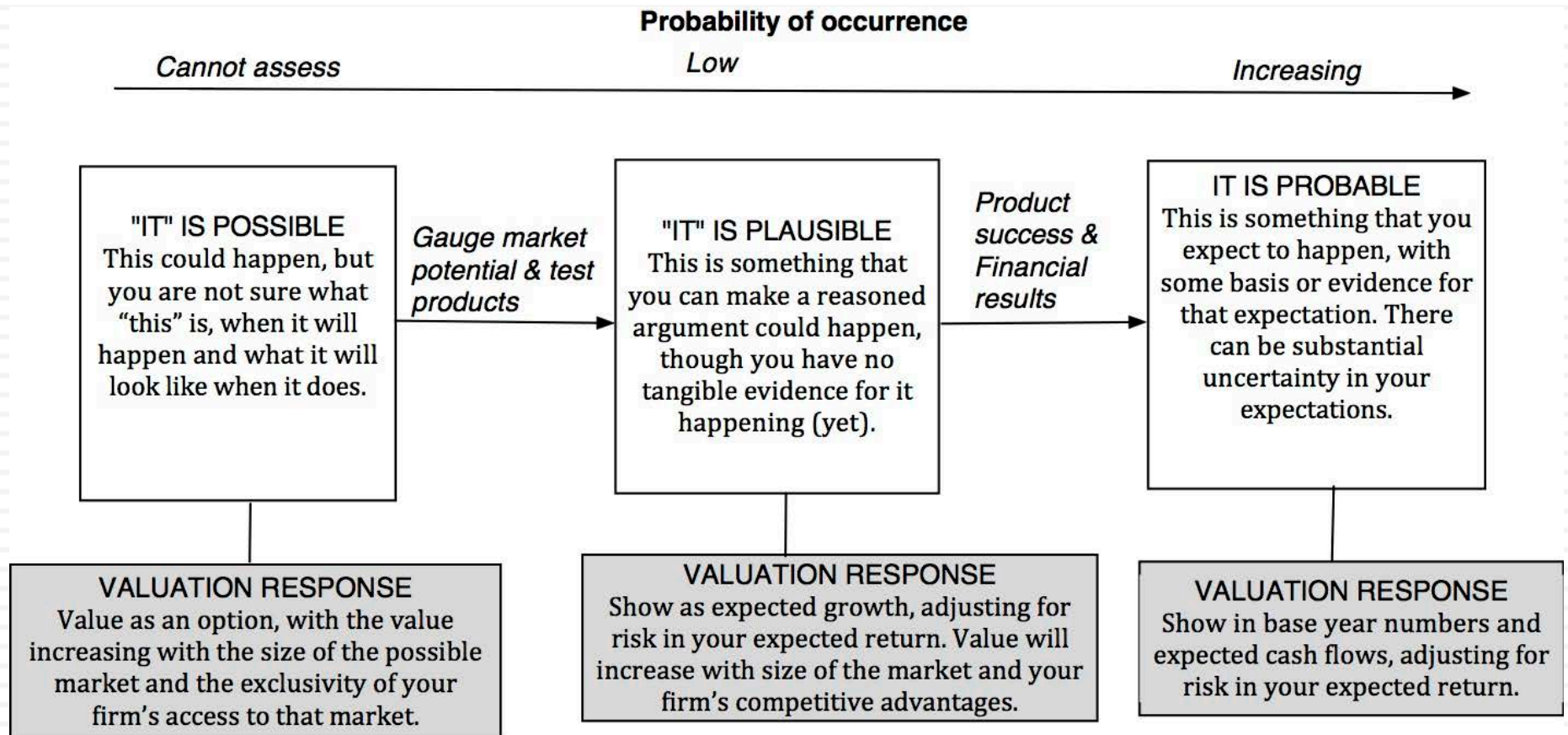

The Impossible, The Implausible and the Improbable

151

The Impossible

Bigger than the economy

Assuming Growth rate for company in perpetuity > Growth rate for economy

Bigger than the total market

Allowing a company's revenues to grow so much that it has more than a 100% market share of whatever business it is in.

Profit margin > 100%

Assuming earnings growth will exceed revenue growth for a long enough period, and pushing margins above 100%

Depreciation without cap ex

Assuming that depreciation will exceed cap ex in perpetuity.

The Implausible

Growth without reinvestment

Assuming growth forever without reinvestment.

Profits without competition

Assuming that your company will grow and earn higher profits, with no competition.

Returns without risk

Assuming that you can generate high returns in a business with no risk.

The Improbable

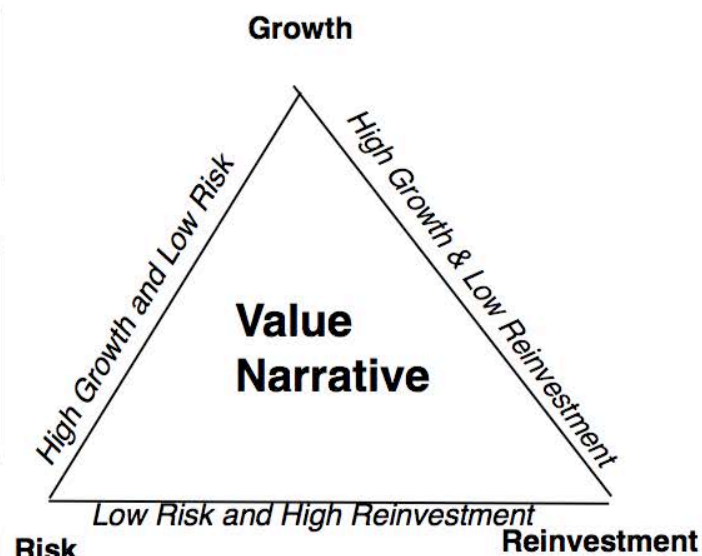

Uber: Possible, Plausible and Probable

Uber (My narrative))

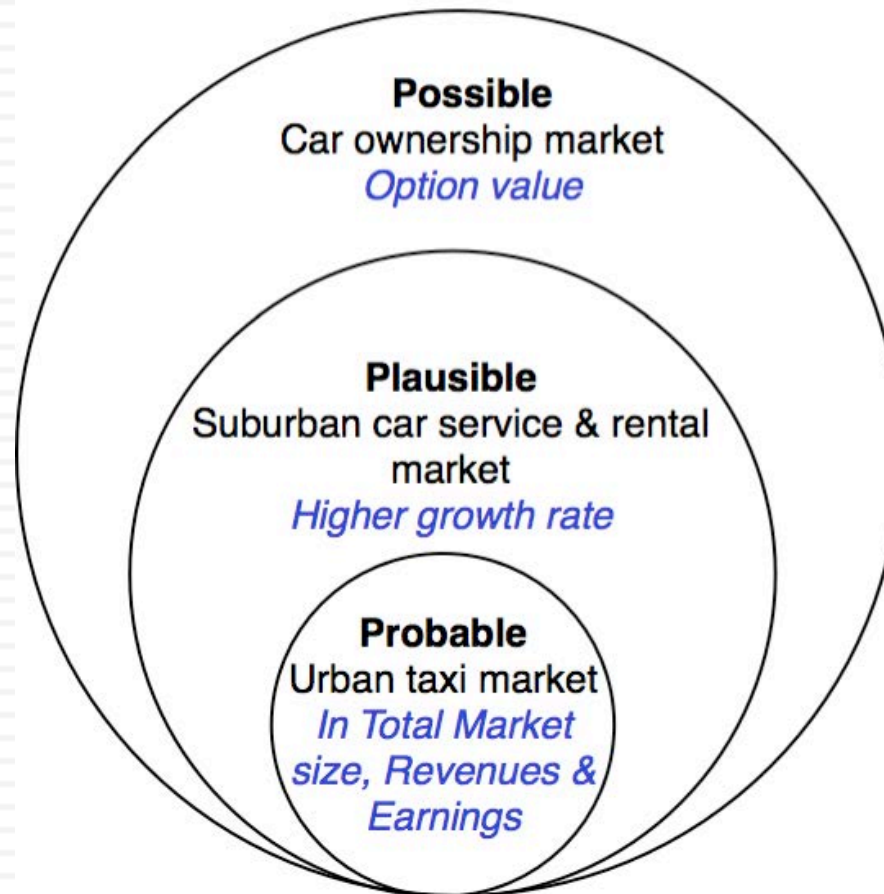

Step 4: Connect your narrative to key drivers of value

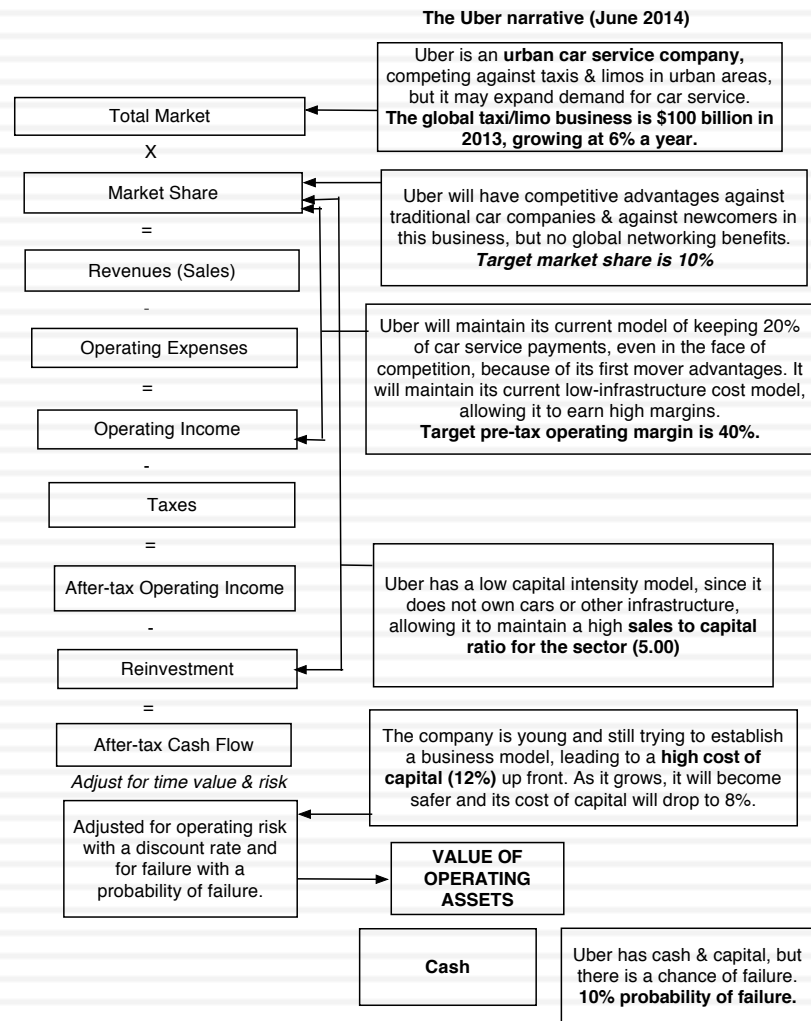

Ferrari: From story to numbers

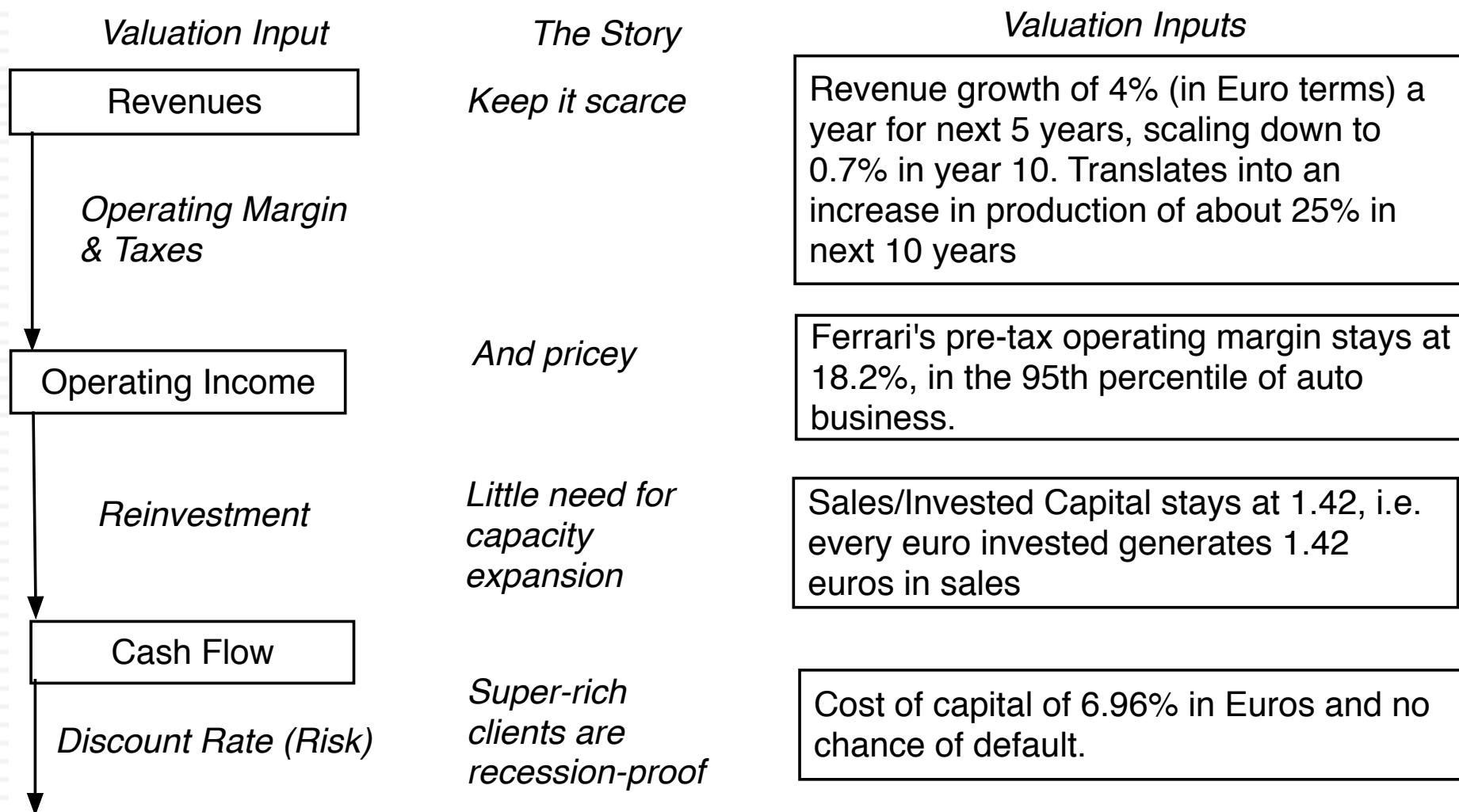

Step 5: Value the company (Uber)

155

Uber: Intrinsic valuation - June 8, 2014 (in US \$)

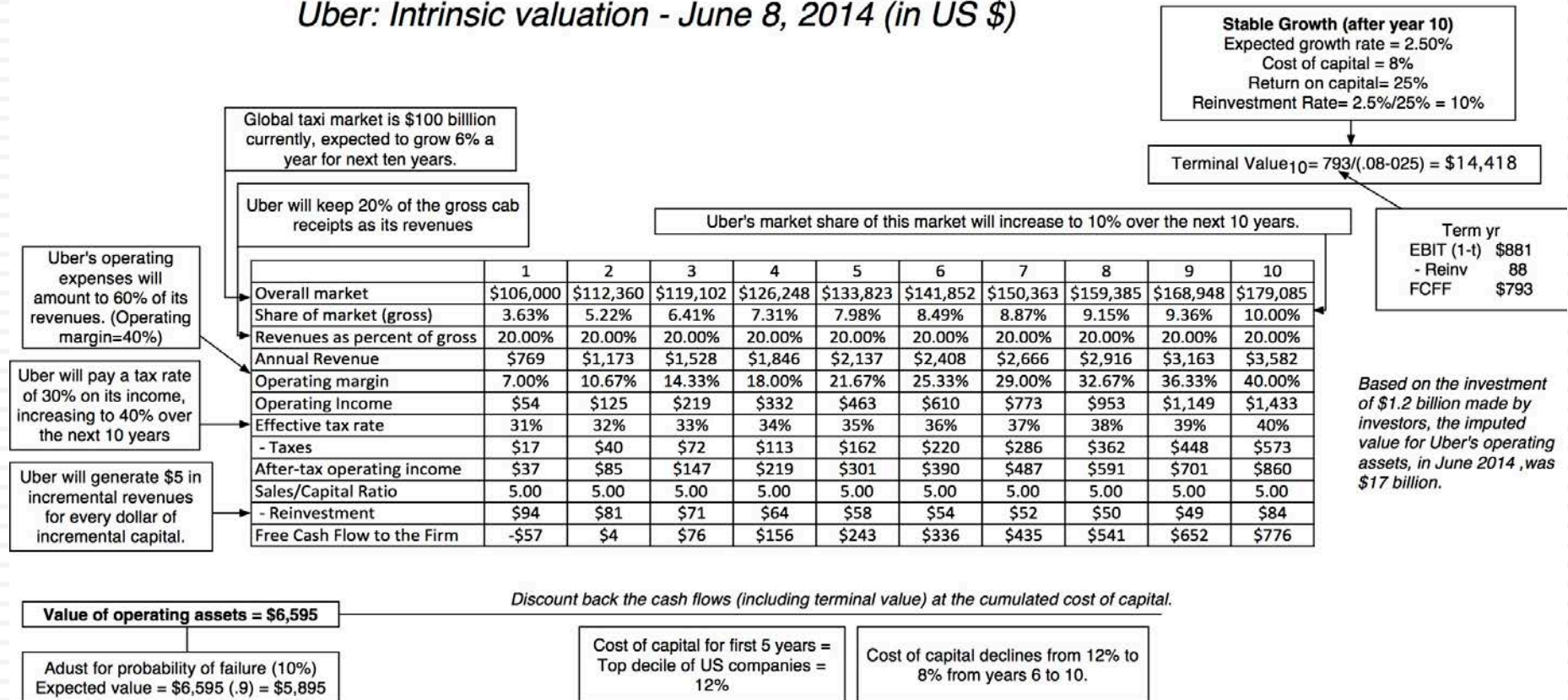

Ferrari: The “Exclusive Club” Value

Stay Super Exclusive: Revenue growth is low

	Base year	1	2	3	4	5	6	7	8	9	10	Terminal year
Revenue growth rate		4.00%	4.00%	4.00%	4.00%	4.00%	3.34%	2.68%	2.02%	1.36%	0.70%	0.70%
Revenues	€ 2,763	€ 2,874	€ 2,988	€ 3,108	€ 3,232	€ 3,362	€ 3,474	€ 3,567	€ 3,639	€ 3,689	€ 3,714	€ 3,740
EBIT (Operating) margin	18.20%	18.20%	18.20%	18.20%	18.20%	18.20%	18.20%	18.20%	18.20%	18.20%	18.20%	18.20%
EBIT (Operating income)	€ 503	€ 523	€ 544	€ 566	€ 588	€ 612	€ 632	€ 649	€ 662	€ 671	€ 676	€ 681
Tax rate	33.54%	33.54%	33.54%	33.54%	33.54%	33.54%	33.54%	33.54%	33.54%	33.54%	33.54%	33.54%
EBIT(1-t)	€ 334	€ 348	€ 361	€ 376	€ 391	€ 407	€ 420	€ 431	€ 440	€ 446	€ 449	€ 452
- Reinvestment		€ 78	€ 81	€ 84	€ 87	€ 91	€ 79	€ 66	€ 51	€ 35	€ 18	€ 22
FCFF		€ 270	€ 281	€ 292	€ 303	€ 316	€ 341	€ 366	€ 389	€ 411	€ 431	€ 431
Cost of capital		6.96%	6.96%	6.96%	6.96%	6.96%	6.96%	6.97%	6.98%	6.99%	7.00%	7.00%
PV(FCFF)		€ 252	€ 245	€ 238	€ 232	€ 225	€ 228	€ 228	€ 227	€ 224	€ 220	
Terminal value	€ 6,835											
PV(Terminal value)	€ 3,485											
PV (CF over next 10 years)	€ 2,321											
Value of operating assets =	€ 5,806											
- Debt	€ 623											
- Minority interests	€ 13											
+ Cash	€ 1,141											
Value of equity	€ 6,311											

High Prices
+ No selling
cost =
Preserve
current
operating
margin

Minimal
Reinvestment
due to low
growth

The super
rich are not
sensitive to
economic
downturns

Step 5: Keep the feedback loop

157

1. Not just car service company.: Uber is a car company, not just a car service company, and there may be a day when consumers will subscribe to a Uber service, rather than own their own cars. It could also expand into logistics, i.e., moving and transportation businesses.
2. Not just urban: Uber can create new demands for car service in parts of the country where taxis are not used (suburbia, small towns).
3. Global networking benefits: By linking with technology and credit card companies, Uber can have global networking benefits.

Valuing Bill Gurley's Uber narrative

	<i>Uber (Gurley)</i>	<i>Uber (Gurley Mod)</i>	<i>Uber (Damodaran)</i>
Narrative	Uber will <u>expand the car service market substantially</u> , bringing in mass transit users & non-users from the suburbs into the market, and use its <u>networking advantage to gain a dominant market share</u> , while maintaining its revenue slice at 20%.	Uber will <u>expand the car service market substantially</u> , bringing in mass transit users & non-users from the suburbs into the market, and use its <u>networking advantage to gain a dominant market share</u> , while cutting prices and margins (to 10%).	Uber will expand the car service market moderately, primarily in urban environments, and use its <u>competitive advantages to get a significant but not dominant market share</u> and maintain its revenue slice at 20%.
Total Market	\$300 billion, growing at 3% a year	\$300 billion, growing at 3% a year	\$100 billion, growing at 6% a year
Market Share	40%	40%	10%
Uber's revenue slice	20%	10%	20%
Value for Uber	\$53.4 billion + Option value of entering car ownership market (\$10 billion+)	\$28.7 billion + Option value of entering car ownership market (\$6 billion+)	\$5.9 billion + Option value of entering car ownership market (\$2-3 billion)

Different narratives, Different Numbers

<i>Total Market</i>	<i>Growth Effect</i>	<i>Network Effect</i>	<i>Competitive Advantages</i>	<i>Value of Uber</i>
A4. Mobility Services	B4. Double market size	C5. Strong global network effects	D4. Strong & Sustainable	\$90,457
A3. Logistics	B4. Double market size	C5. Strong global network effects	D4. Strong & Sustainable	\$65,158
A4. Mobility Services	B3. Increase market by 50%	C3. Strong local network effects	D3. Semi-strong	\$52,346
A2. All car service	B4. Double market size	C5. Strong global network effects	D4. Strong & Sustainable	\$47,764
A1. Urban car service	B4. Double market size	C5. Strong global network effects	D4. Strong & Sustainable	\$31,952
A3. Logistics	B3. Increase market by 50%	C3. Strong local network effects	D3. Semi-strong	\$14,321
A1. Urban car service	B3. Increase market by 50%	C3. Strong local network effects	D3. Semi-strong	\$7,127
A2. All car service	B3. Increase market by 50%	C3. Strong local network effects	D3. Semi-strong	\$4,764
A4. Mobility Services	B1. None	C1. No network effects	D1. None	\$1,888
A3. Logistics	B1. None	C1. No network effects	D1. None	\$1,417
A2. All car service	B1. None	C1. No network effects	D1. None	\$1,094
A1. Urban car service	B1. None	C1. No network effects	D1. None	\$799

The Ferrari Counter Narrative

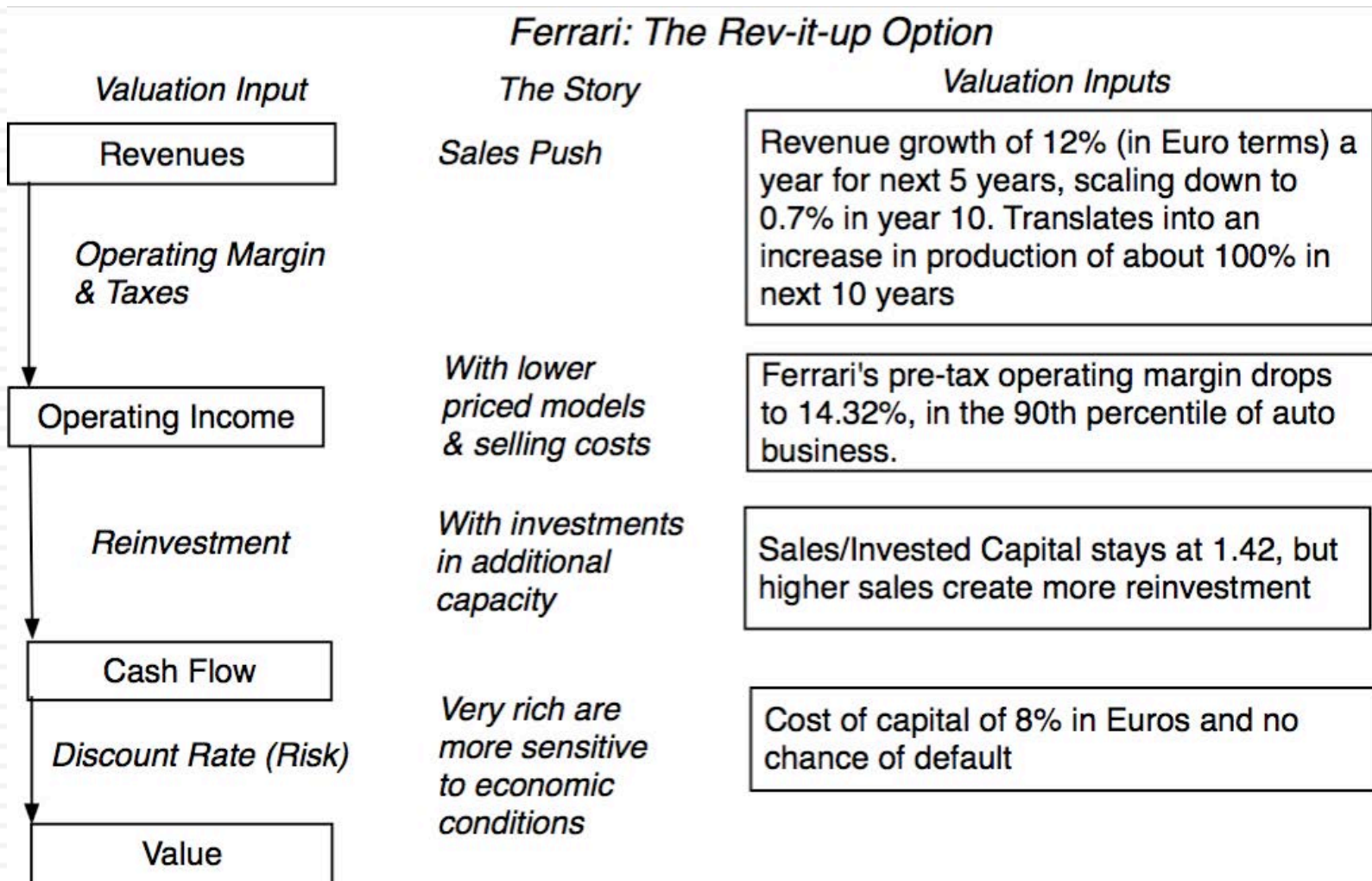

Ferrari: The “Rev-it-up” Alternative

Get less exclusive: Double number of cars sold over next decade

	Base year	1	2	3	4	5	6	7	8	9	10	Terminal year
Revenue growth rate		12.00%	12.00%	12.00%	12.00%	12.00%	9.74%	7.48%	5.22%	2.96%	0.70%	0.70%
Revenues	€ 2,763	€ 3,095	€ 3,466	€ 3,882	€ 4,348	€ 4,869	€ 5,344	€ 5,743	€ 6,043	€ 6,222	€ 6,266	€ 6,309
EBIT (Operating) margin	18.20%	17.81%	17.42%	17.04%	16.65%	16.26%	15.87%	15.48%	15.10%	14.71%	14.32%	14.32%
EBIT (Operating income)	€ 503	€ 551	€ 604	€ 661	€ 724	€ 792	€ 848	€ 889	€ 912	€ 915	€ 897	€ 904
Tax rate	33.54%	33.54%	33.54%	33.54%	33.54%	33.54%	33.54%	33.54%	33.54%	33.54%	33.54%	33.54%
EBIT(1-t)	€ 334	€ 366	€ 401	€ 439	€ 481	€ 526	€ 564	€ 591	€ 606	€ 608	€ 596	€ 600
- Reinvestment		€ 233	€ 261	€ 293	€ 328	€ 367	€ 334	€ 281	€ 211	€ 126	€ 31	€ 35
FCFF		€ 133	€ 140	€ 147	€ 153	€ 159	€ 230	€ 310	€ 395	€ 482	€ 566	€ 565
Cost of capital		8.00%	8.00%	8.00%	8.00%	8.00%	7.90%	7.80%	7.70%	7.60%	7.50%	7.50%
PV(FCFF)		€ 123	€ 120	€ 117	€ 113	€ 108	€ 145	€ 181	€ 215	€ 244	€ 266	
Terminal value	€ 8,315											
PV(Terminal value)	€ 3,906											
PV (CF over next 10 years)	€ 1,631											
Value of operating assets =	€ 5,537											
- Debt	€ 623											
- Minority interests	€ 13											
+ Cash	€ 1,141											
Value of equity	€ 6,042											

Lower Prices +
Some selling
cost = Lower
operating
margin

Reinvestment
reflects
higher sales

The very
rich are
more
sensitive to
economic
conditions

And the world is full of feedback.. My Ferrari afterthought!



Step 6: Be ready to modify narrative as events unfold

163

Narrative Break/End	Narrative Shift	Narrative Change (Expansion or Contraction)
Events, external (legal, political or economic) or internal (management, competitive, default), that can cause the narrative to break or end.	Improvement or deterioration in initial business model, changing market size, market share and/or profitability.	Unexpected entry/success in a new market or unexpected exit/failure in an existing market.
Your valuation estimates (cash flows, risk, growth & value) are no longer operative	Your valuation estimates will have to be modified to reflect the new data about the company.	Valuation estimates have to be redone with new overall market potential and characteristics.
Estimate a probability that it will occur & consequences	Monte Carlo simulations or scenario analysis	Real Options

Uber: The September 2015 Update

<i>Input</i>	<i>June 2014</i>	<i>September 2015</i>	<i>Rationale</i>
Total Market	\$100 billion; Urban car service	\$230 billion; Logistics	Market is broader, bigger & more global than I thought it would be. <u>Uber's</u> entry into delivery & moving businesses is now plausible, perhaps even probable.
Growth in market	Increase market size by 34%; CAGR of 6%.	Double market size; CAGR of 10.39%.	New customers being drawn to car sharing, with more diverse offerings.
Market Share	10% (Local Networking)	25% (Weak Global Networking)	Higher cost of entry will reduce competitors, but remaining competitors have access to capital & in Asia, the hometown advantage.
Slice of gross receipts	20% (Left at status quo)	15%	Increased competition will reduce car service company slice.
Operating margin	40% (Low cost model)	25% (Partial employee model)	Drivers will become partial employees, higher insurance and regulatory costs.
Cost of capital	12% (Ninth decile of US companies)	10% (75 th percentile of US companies)	Business model in place and substantial revenues.
Probability of failure	10%	0%	Enough cash on hand to find off threats to survival.
Value of equity	\$5.9 billion	\$23.4 billion	Value increased more than four fold.

Potential Market	Market size (in millions)
A1. Urban car service	\$100,000
A2. All car service	\$175,000
A3. Logistics	\$230,000
A4. Mobility Services	\$310,000

Growth Effect	CAGR (next 10 years)
B1. None	3.00%
B2. Increase market by 25%	5.32%
B3. Increase market size by 50%	7.26%
B4: Double market size	10.39%

Network Effects	Market Share
C1. No network effects	5%
C2. Weak local network effects	10%
C3. Strong local network effects	15%
C4. Weak global network effects	25%
C5. Strong global network effects	40%

Increases overall market to \$618 billion in year 10

	Base	2016	2017	2018	2019	2020	2021	2022	2023	2024	2025	Assumptions
Overall market	\$230,000	\$253,897	\$280,277	\$309,398	\$341,544	\$377,031	\$416,204	\$459,448	\$507,184	\$559,881	\$618,052	A3 & B4
Share of market (gross)	4.71%	6.74%	8.77%	10.80%	12.83%	14.86%	16.89%	18.91%	20.94%	22.97%	25.00%	C4
Gross Billings	\$10,840	\$17,117	\$24,582	\$33,412	\$43,813	\$56,014	\$70,277	\$86,900	\$106,218	\$128,612	\$154,513	
Revenues as percent of gross	20.00%	19.50%	19.00%	18.50%	18.00%	17.50%	17.00%	16.50%	16.00%	15.50%	15.00%	D3
Annual Revenue	\$2,168	\$3,338	\$4,670	\$6,181	\$7,886	\$9,802	\$11,947	\$14,338	\$16,995	\$19,935	\$23,177	
Operating margin	-23.06%	-18.26%	-13.45%	-8.64%	-3.84%	0.97%	5.77%	10.58%	15.39%	20.19%	25.00%	E2
Operating Income	-\$500	-\$609	-\$628	-\$534	-\$303	\$95	\$690	\$1,517	\$2,615	\$4,026	\$5,794	
Effective tax rate	30.00%	31.00%	32.00%	33.00%	34.00%	35.00%	36.00%	37.00%	38.00%	39.00%	40.00%	
- Taxes	-\$150	-\$189	-\$201	-\$176	-\$103	\$33	\$248	\$561	\$994	\$1,570	\$2,318	
After-tax operating income	-\$350	-\$420	-\$427	-\$358	-\$200	\$62	\$442	\$956	\$1,621	\$2,456	\$3,477	
Sales/Capital Ratio		5.00	5.00	5.00	5.00	5.00	5.00	5.00	5.00	5.00	5.00	F
- Reinvestment		\$234	\$267	\$302	\$341	\$383	\$429	\$478	\$531	\$588	\$648	
Free Cash Flow to the Firm		-\$654	-\$694	-\$660	-\$541	-\$322	\$13	\$478	\$1,090	\$1,868	\$2,828	
Terminal value											\$56,258	
Present value of FCFF		-\$595	-\$573	-\$496	-\$369	-\$200	\$7	\$248	\$520	\$822	\$1,152	
Present value of terminal value											\$22,914	
Cost of capital	10.00%	10.00%	10.00%	10.00%	10.00%	10.00%	9.60%	9.20%	8.80%	8.40%	8.00%	G1

PV of cash flows during next 10 years =	\$515	
PV of terminal value =	\$22,914	
Value of operating assets	\$23,429	
Probability of failure	0.00%	G2
Adjusted value of operating assets	\$23,429	
Less Debt	\$0	
Value of Equity	\$23,429	

Expense Profile	Operating Margin
E1: Independent contractor	40%
E2: Partial employee	25%
E3: Full employee	15%

Capital Intensity
F: Status Quo: Sales/Capital = 5

Competitive Advantages	Slice of Gross Receipts
D1. None	5%
D2. Weak	10%
D3. Semi-strong	15%
D4. Strong & Sustainable	20%

Risk Estimates

- G1. Cost of capital at 75th percentile of US companies = 10%
- G2. Probability of failure in next 10 years= 0%

Uber Valuation: September 2015

Henkel

The Story

Henkel is a stolid (solid and conservatively run) company that has an established presence and brand name power in each of its three markets (industrial adhesives, laundry detergents and household goods) but is unlikely to stray too far (geographically, leverage-wise or business-wise) from its existing domains.

The Assumptions

	Base year	Years 1-5	Years 6-10		After year 10	Link to story
Revenues (a)	\$ 18,074	4.20%	4.2%→2.2%		0.03%	Solid and slow growth
Operating margin (b)	15.25%	15.25%	→ 12.80%		12.80%	Strong presence and brand name
Tax rate	25.00%	25.00%	→ 25.00%		25.00%	Not a risk taker when it comes to taxes
Reinvestment (c)		Sales to capital ratio = 1.52		RIR =	0.43%	Nor with reinvestment
Return on capital	15.26%	Marginal ROIC = 8.37%			7.00%	Global competition will wear on returns
Cost of capital (d)		7.48%	→ 7.00%		7.00%	Or with business & leverage risk

The Cash Flows

	Revenues	Operating Margin	EBIT	EBIT (1-t)	Reinvestment	FCFF
1	\$ 18,833	15.00%	\$ 2,826	\$ 2,119	\$ 499	\$ 1,620
2	\$ 19,624	14.76%	\$ 2,896	\$ 2,172	\$ 520	\$ 1,652
3	\$ 20,448	14.51%	\$ 2,968	\$ 2,226	\$ 542	\$ 1,684
4	\$ 21,307	14.27%	\$ 3,040	\$ 2,280	\$ 565	\$ 1,715
5	\$ 22,202	14.02%	\$ 3,114	\$ 2,335	\$ 589	\$ 1,746
6	\$ 22,949	13.78%	\$ 3,162	\$ 2,372	\$ 492	\$ 1,880
7	\$ 23,530	13.53%	\$ 3,185	\$ 2,389	\$ 382	\$ 2,006
8	\$ 23,930	13.29%	\$ 3,180	\$ 2,385	\$ 263	\$ 2,122
9	\$ 24,137	13.04%	\$ 3,149	\$ 2,361	\$ 136	\$ 2,225
10	\$ 24,144	12.80%	\$ 3,090	\$ 2,318	\$ 5	\$ 2,313
Terminal year	\$ 24,151	12.80%	\$ 3,091	\$ 2,319	\$ 10	\$ 2,309

The Value

Terminal value	\$ 33,122		
PV(Terminal value)	\$ 16,316		
PV (CF over next 10 years)	\$ 12,741		
Value of operating assets =	\$ 29,057		
Adjustment for distress	\$ -	Probability of failure =	0.00%
- Debt & Mnority Interests	\$ 2,186		
+ Cash & Other Non-operating assets	\$ 2,305		
Value of equity	\$ 29,176		
- Value of equity options	\$ -		
Number of shares	399.83		
Value per share	\$ 72.97	Stock was trading at =	\$118.22



Aswath Damodaran

RELATIVE VALUATION (PRICING)

Aswath Damodaran

Relative valuation is pervasive...

- Most asset valuations are relative.
- Most equity valuations on Wall Street are relative valuations.
 - Almost 85% of equity research reports are based upon a multiple and comparables.
 - More than 50% of all acquisition valuations are based upon multiples
 - Rules of thumb based on multiples are not only common but are often the basis for final valuation judgments.
- While there are more discounted cashflow valuations in consulting and corporate finance, they are often relative valuations masquerading as discounted cash flow valuations.
 - The objective in many discounted cashflow valuations is to back into a number that has been obtained by using a multiple.
 - The terminal value in a significant number of discounted cashflow valuations is estimated using a multiple.

The Reasons for the allure...

- “If you think I’ m crazy, you should see the guy who lives across the hall”

Jerry Seinfeld talking about Kramer in a Seinfeld episode

- “ A little inaccuracy sometimes saves tons of explanation”

H.H. Munro

- “ If you are going to screw up, make sure that you have lots of company”

Ex-portfolio manager

Pricing versus Valuation

170

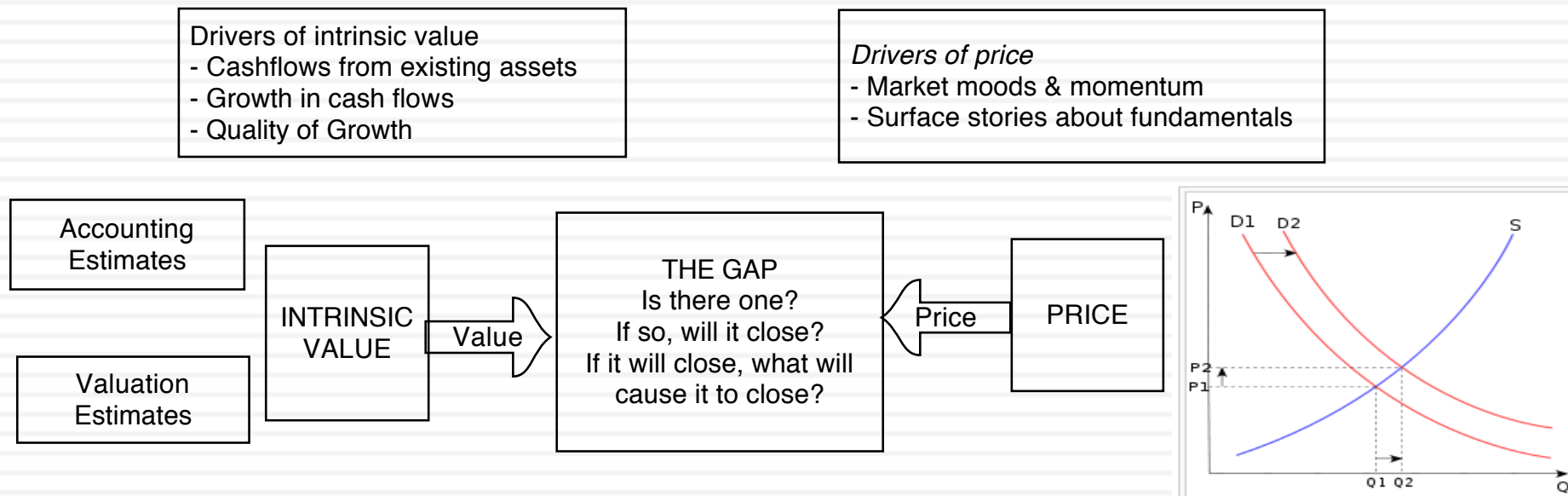

Test 1: Are you pricing or valuing?

171



5369 La Jolla Mesa Dr
La Jolla, CA 92037
Status: Active





\$995,000
Price

3
Beds

2.5
Baths

1,440 Sq. Ft.
\$691 / Sq. Ft.

Built: 1955 **Lot Size:** 3,000 Sq. Ft. **On Redfin:** 12 days

Favorite X-Out Share... Tour Home

[Overview](#) [Property Details](#) [Tour Insights](#) [Property History](#) [Public Records](#) [Activity](#) [Schools](#) [Neighborhood & Offer Insights](#) [Similar Homes](#)



1 of 25  [Play Video](#)

Lisa Padilla
REDFIN Real Estate Agent

★★★★★
47 client reviews

\$8,726 commission refund

[Go Tour This Home](#)

[Ask Lisa a Question](#) or [Start an Offer](#)

1 of 4 Redfin Agents in this area

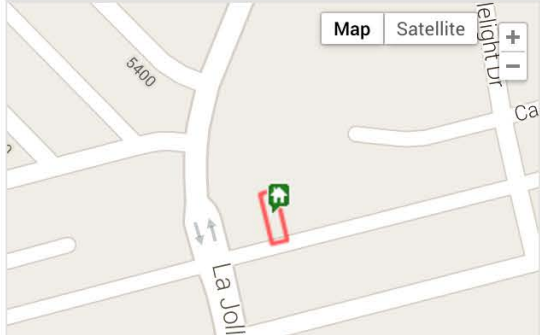

Map Satellite

Test 2: Are you pricing or valuing?

172

Europe
Switzerland

Biotechnology
Biotechnology

Reuters
BION.S

Bloomberg
BION SW

Exchange
SWX
Ticker
BION

Price at 12 Aug 2013 (CHF)	124.00
Price Target (CHF)	164.50
52-week range (CHF)	128.40 - 84.90

Strong sector and stock-picking continue

Impressive performance

Over the past two years, BB Biotech shares have roughly tripled, which could tempt investors to take profits. However, this performance has been well backed by a deserved revival of the biotech industry, encouraging fundamental news, M&A, and increased money flow into health care stocks. In addition, BBB returned to index outperformance by modifying its stock-picking approach. Hence, despite excellent performance, the shares still trade at a 23% discount to the net asset value of the portfolio. Hence, the shares are an attractive value vehicle to capture growth opportunities in an attractive sector.

Biotech industry remains attractive

With the re-rating of the pharma sector, investors have also showed increased interest in biotech stocks. Established biotech stocks have delivered encouraging financial results and approvals, while there has also been substantial industry consolidation, which is not surprising in times of "cheap" money and high liquidity. BB Biotech remains an attractive vehicle to capture the future potential of the biotech sector. In addition, investors benefit from a 23% discount to NAV and attractive cash distribution policy of 5% yield p.a. Hence, we reiterate our Buy on BB Biotech shares.

Key changes

Target Price 106.50 to 164.50 ↑ 54.5%

Source: Deutsche Bank

Price/price relative

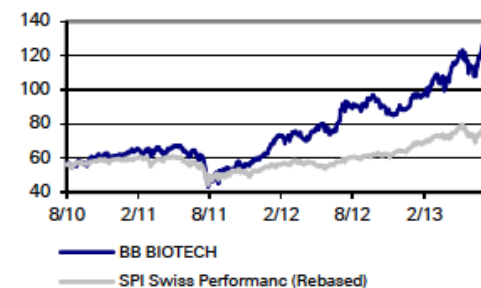

Performance (%)	1m	3m	12m
Absolute	-1.4	5.4	37.4

Test 3: Are you pricing or valuing?

173

	1	2	3	4	5
EBITDA	\$100.00	\$120.00	\$144.00	\$172.80	\$207.36
- Depreciation	\$20.00	\$24.00	\$28.80	\$34.56	\$41.47
EBIT	\$80.00	\$96.00	\$115.20	\$138.24	\$165.89
- Taxes	\$24.00	\$28.80	\$34.56	\$41.47	\$49.77
EBIT (1-t)	\$56.00	\$67.20	\$80.64	\$96.77	\$116.12
+ Depreciation	\$20.00	\$24.00	\$28.80	\$34.56	\$41.47
- Cap Ex	\$50.00	\$60.00	\$72.00	\$86.40	\$103.68
- Chg in WC	\$10.00	\$12.00	\$14.40	\$17.28	\$20.74
FCFF	\$16.00	\$19.20	\$23.04	\$27.65	\$33.18
Terminal Value					\$1,658.88
Cost of capital	8.25%	8.25%	8.25%	8.25%	8.25%
Present Value	\$14.78	\$16.38	\$18.16	\$20.14	\$1,138.35
Value of operating assets today	\$1,207.81				
+ Cash	\$125.00				
- Debt	\$200.00				
Value of equity	\$1,132.81				

The tool for pricing: A multiple

174

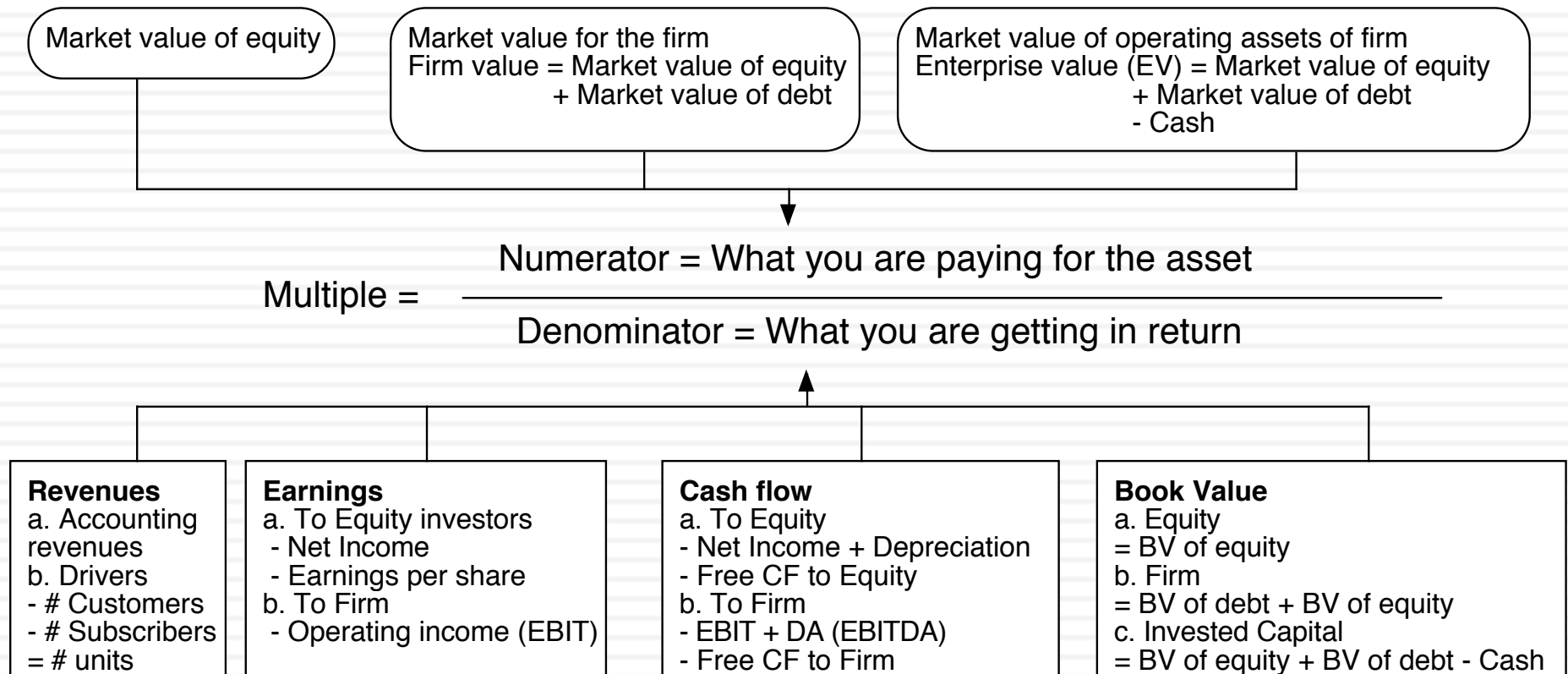

The Pricing Game: Choices

Measure	Choices	Considerations/ Questions
Value	Enterprise, Equity or Firm Value?	<ol style="list-style-type: none"> 1. Is this a financial service business? 2. Are there big differences in leverage?
Scalar	Revenues, Earnings, Cash Flows or Book Value?	<ol style="list-style-type: none"> 1. How are you measuring value? 2. Is the scaling number positive? 3. How (and how much) do accounting choices affect the scaling measure?
Timing & Normalizing	Current, Trailing, Forward or Really Forward?	<ol style="list-style-type: none"> 1. Where are you in the life cycle? 2. How much cyclicity is there in the number? 3. Can you get forecasted values?
Comparable	What is your peer group? (Global or local? Similar size or all firms? ...)	<ol style="list-style-type: none"> 1. How much do companies share in common globally? 2. Does company size affect business economics? 3. How big a sample of firms do you need? 4. How do you plan to control for differences?

The Four Steps to Deconstructing Multiples

- Define the multiple
 - In use, the same multiple can be defined in different ways by different users. When comparing and using multiples, estimated by someone else, it is critical that we understand how the multiples have been estimated
- Describe the multiple
 - Too many people who use a multiple have no idea what its cross sectional distribution is. If you do not know what the cross sectional distribution of a multiple is, it is difficult to look at a number and pass judgment on whether it is too high or low.
- Analyze the multiple
 - It is critical that we understand the fundamentals that drive each multiple, and the nature of the relationship between the multiple and each variable.
- Apply the multiple
 - Defining the comparable universe and controlling for differences is far more difficult in practice than it is in theory.

Definitional Tests

- Is the multiple consistently defined?
 - Proposition 1: Both the value (the numerator) and the standardizing variable (the denominator) should be to the same claimholders in the firm. In other words, the value of equity should be divided by equity earnings or equity book value, and firm value should be divided by firm earnings or book value.
- Is the multiple uniformly estimated?
 - The variables used in defining the multiple should be estimated uniformly across assets in the “comparable firm” list.
 - If earnings-based multiples are used, the accounting rules to measure earnings should be applied consistently across assets. The same rule applies with book-value based multiples.

Example 1: Price Earnings Ratio: Definition

PE = Market Price per Share / Earnings per Share

- There are a number of variants on the basic PE ratio in use. They are based upon how the price and the earnings are defined.

Price: is usually the current price

is sometimes the average price for the year

EPS: EPS in most recent financial year

EPS in trailing 12 months (Trailing PE)

Forecasted EPS next year (Forward PE)

Forecasted EPS in future year

Example 2: Enterprise Value /EBITDA Multiple

- The enterprise value to EBITDA multiple is obtained by netting cash out against debt to arrive at enterprise value and dividing by EBITDA.

$$\frac{\text{Enterprise Value}}{\text{EBITDA}} = \frac{\text{Market Value of Equity} + \text{Market Value of Debt} - \text{Cash}}{\text{Earnings before Interest, Taxes and Depreciation}}$$

- Why do we net out cash from firm value?
- What happens if a firm has cross holdings which are categorized as:
 - ▣ Minority interests?
 - ▣ Majority active interests?

Descriptive Tests

- What is the average and standard deviation for this multiple, across the universe (market)?
- What is the median for this multiple?
 - The median for this multiple is often a more reliable comparison point.
- How large are the outliers to the distribution, and how do we deal with the outliers?
 - Throwing out the outliers may seem like an obvious solution, but if the outliers all lie on one side of the distribution (they usually are large positive numbers), this can lead to a biased estimate.
- Are there cases where the multiple cannot be estimated? Will ignoring these cases lead to a biased estimate of the multiple?
- How has this multiple changed over time?

1. Multiples have skewed distributions...

PE Ratios: US companies in January 2017

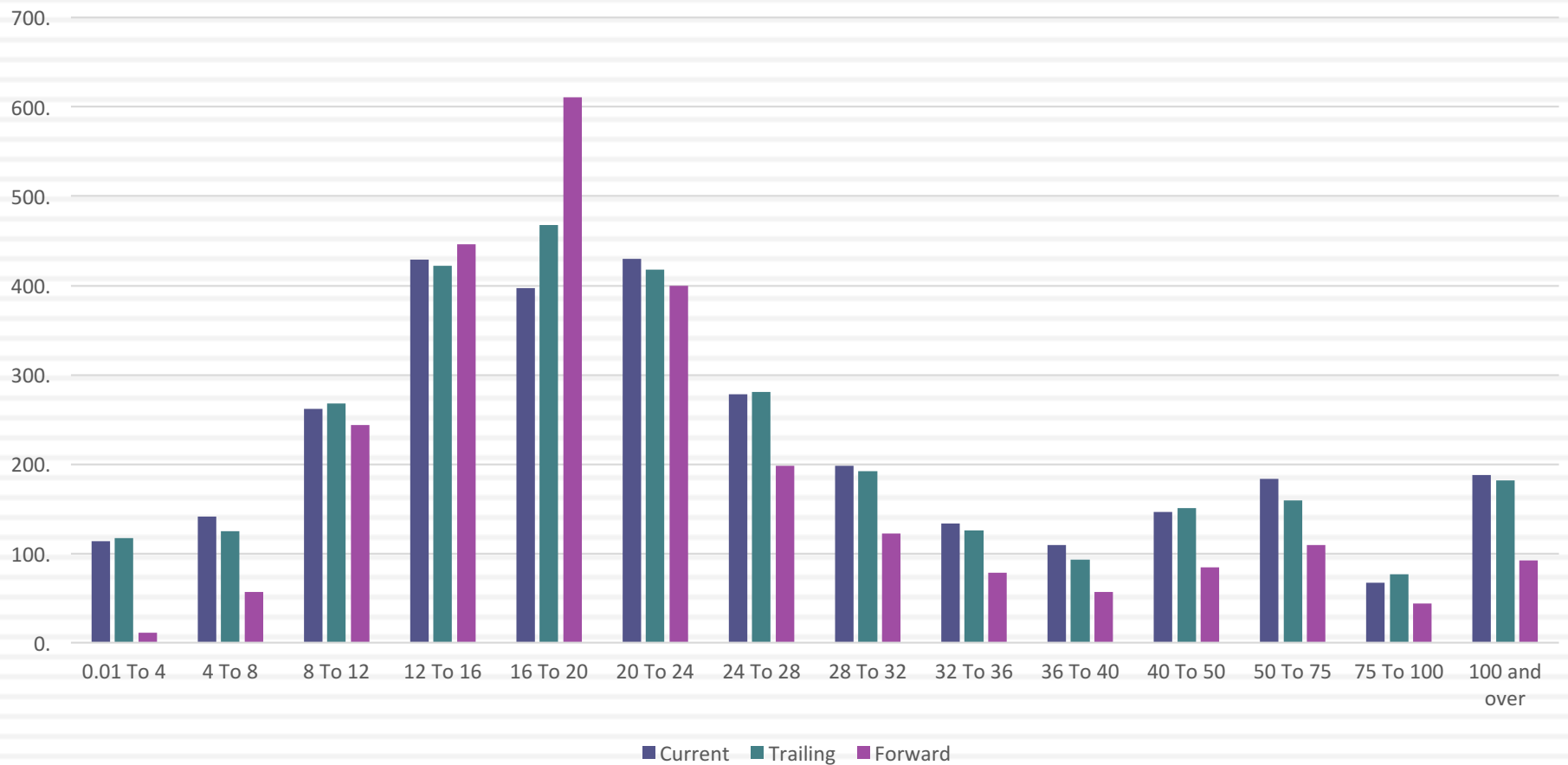

2. Making statistics “dicey”

182

	Current PE	Trailing PE	Forward PE
Number of firms	7330	7330	7330
Number with PE	3,076.	3,081.	2,553.
Average	114.15	77.30	46.11
Median	21.57	21.15	19.25
Minimum	0.05	0.07	0.3
Maximum	134,400.00	62,228.00	28,210.00
Standard deviation	1603.68	769.28	337.16
Standard error	18.73	8.98	3.94
Skewness	80.51	73.51	80.08
25th percentile	14.33	14.40	15.04
75th percentile	33.33	32.39	26.63

US firms in January 2017

3. Markets have a lot in common : Comparing Global PEs

PE Ratios by Region

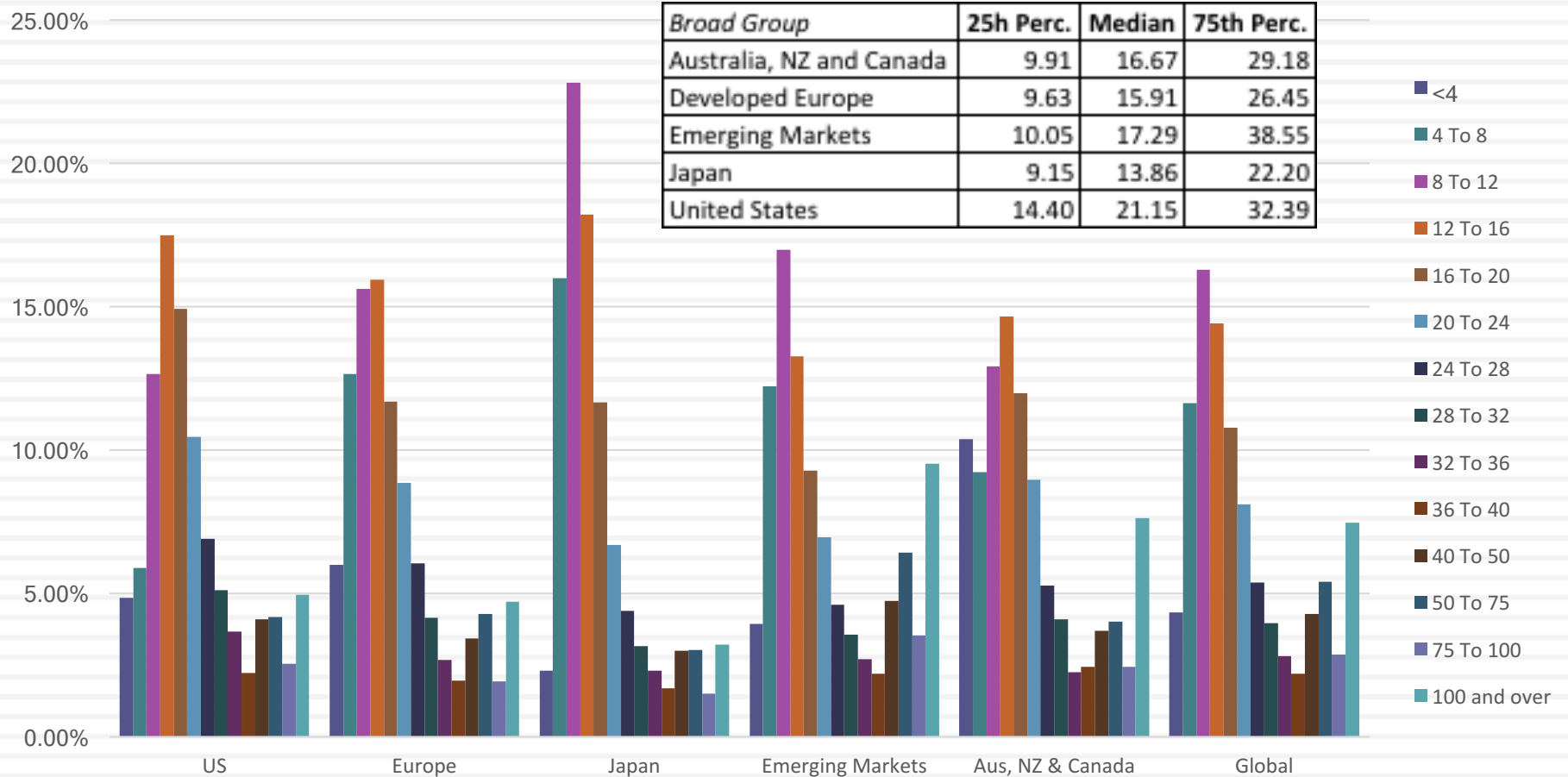

4. Simplistic rules almost always break down...6 times EBITDA may not be cheap...

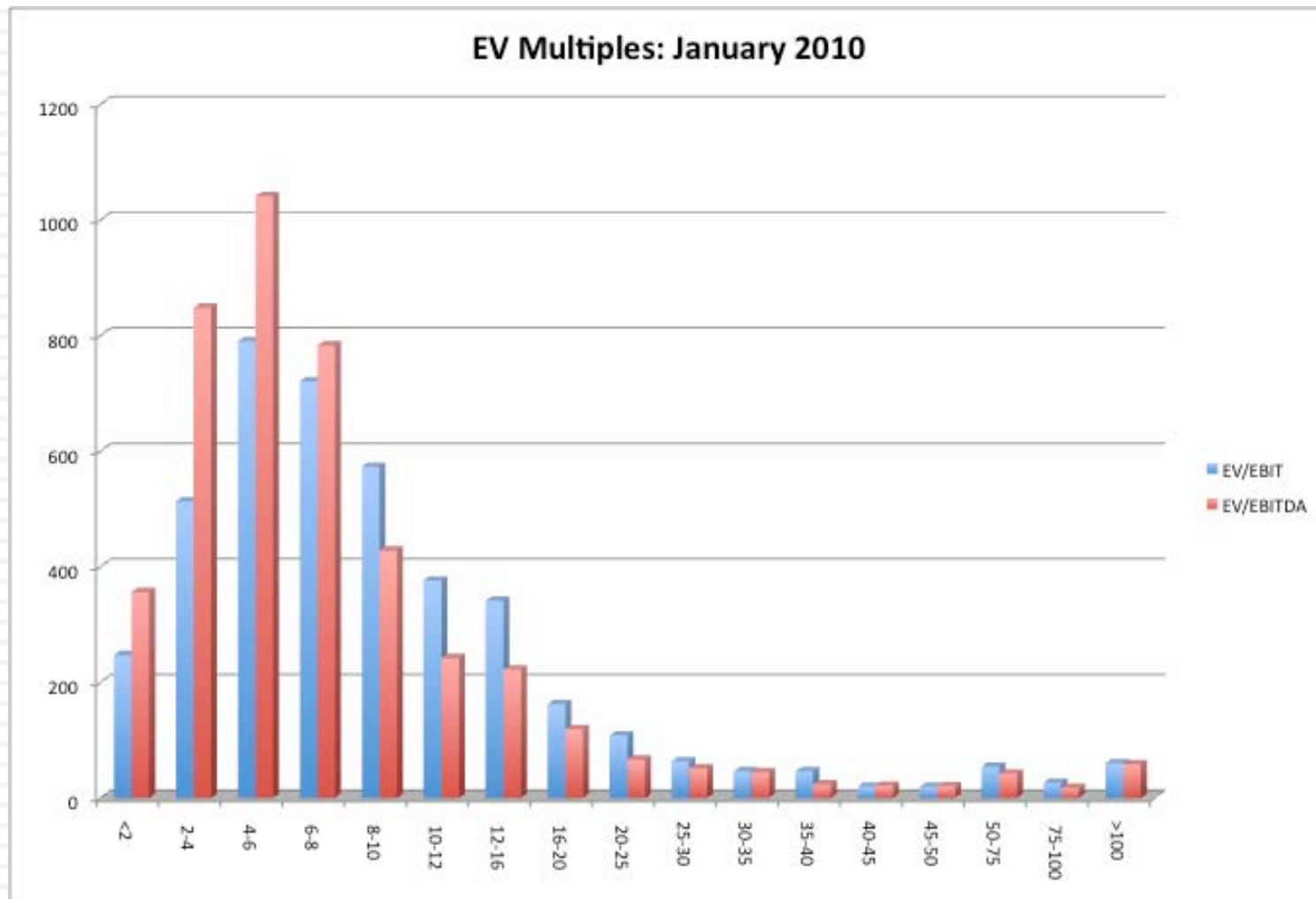

But it may be in 2017, unless you are in Japan!

EV/EBITDA Multiples in January 2017

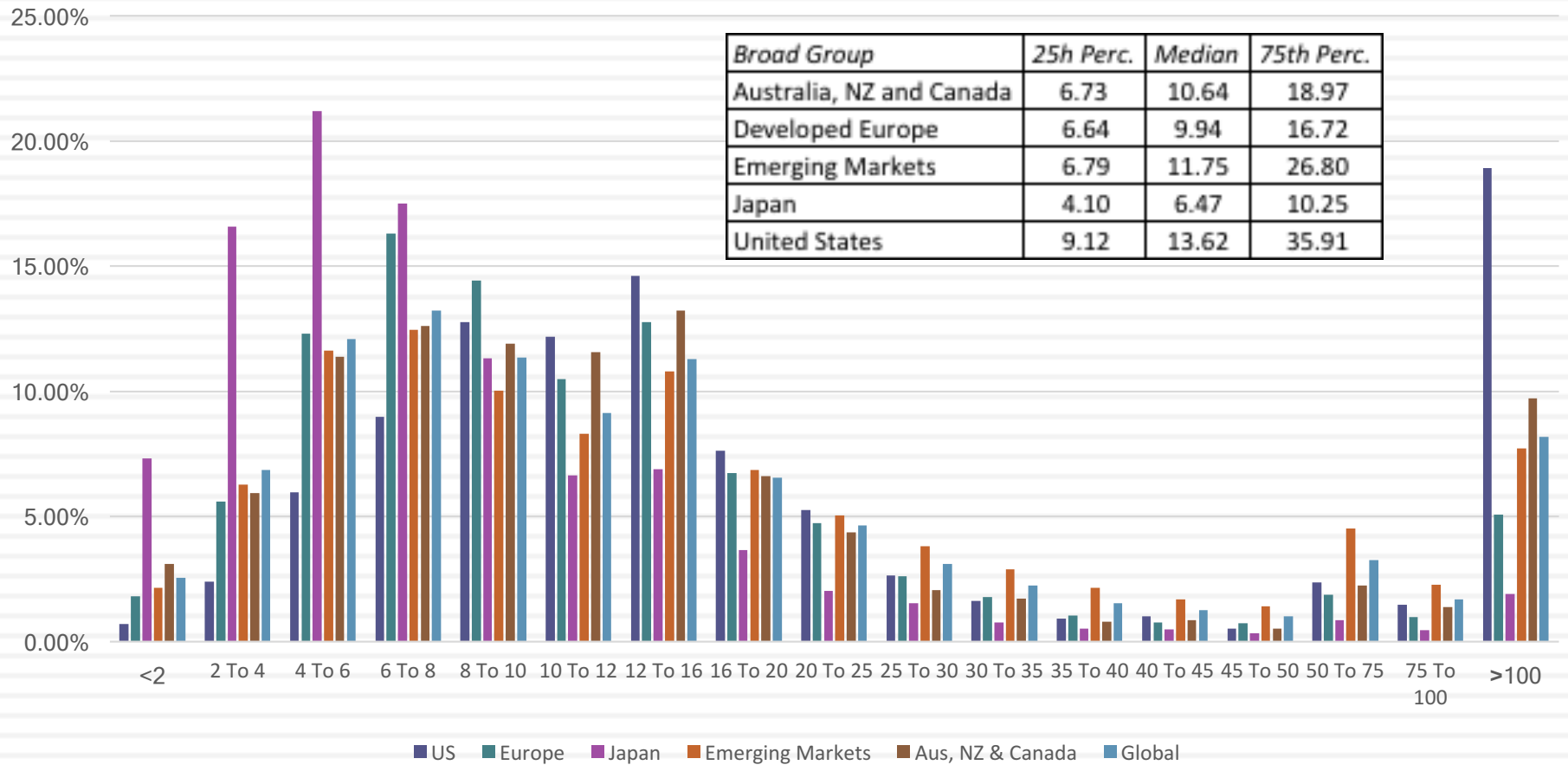

Analytical Tests

- What are the fundamentals that determine and drive these multiples?
 - Proposition 2: Embedded in every multiple are all of the variables that drive every discounted cash flow valuation - growth, risk and cash flow patterns.
 - In fact, using a simple discounted cash flow model and basic algebra should yield the fundamentals that drive a multiple
- How do changes in these fundamentals change the multiple?
 - The relationship between a fundamental (like growth) and a multiple (such as PE) is seldom linear. For example, if firm A has twice the growth rate of firm B, it will generally not trade at twice its PE ratio
 - Proposition 3: It is impossible to properly compare firms on a multiple, if we do not know the nature of the relationship between fundamentals and the multiple.

A Simple Analytical device

187

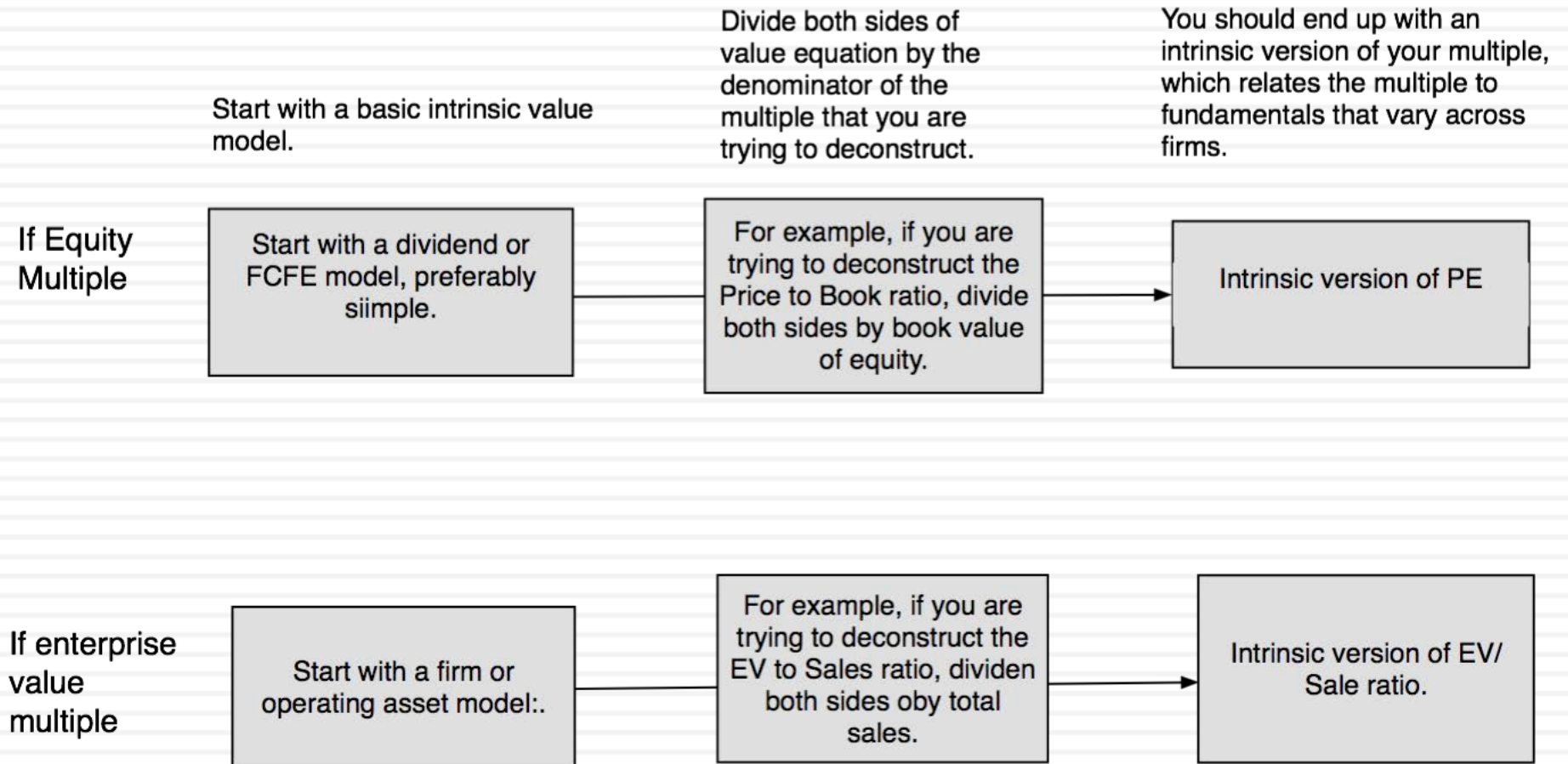

PE Ratio: Understanding the Fundamentals

- To understand the fundamentals, start with a basic equity discounted cash flow model.
- With the dividend discount model,

$$P_0 = \frac{DPS_1}{r - g_n}$$

- Dividing both sides by the current earnings per share,

$$\frac{P_0}{EPS_0} = PE = \frac{\text{Payout Ratio} * (1 + g_n)}{r - g_n}$$

- If this had been a FCFE Model,

$$P_0 = \frac{FCFE_1}{r - g_n}$$

$$\frac{P_0}{EPS_0} = PE = \frac{(FCFE/\text{Earnings}) * (1 + g_n)}{r - g_n}$$

The Determinants of Multiples...

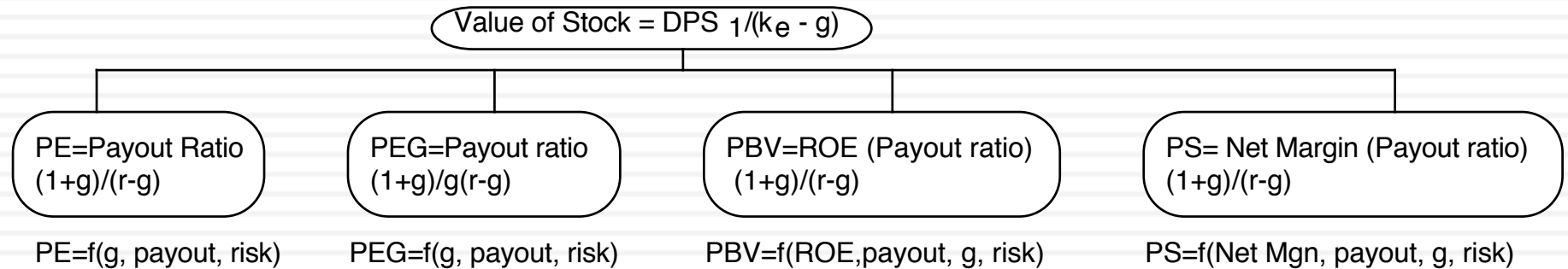

Equity Multiples

Firm Multiples

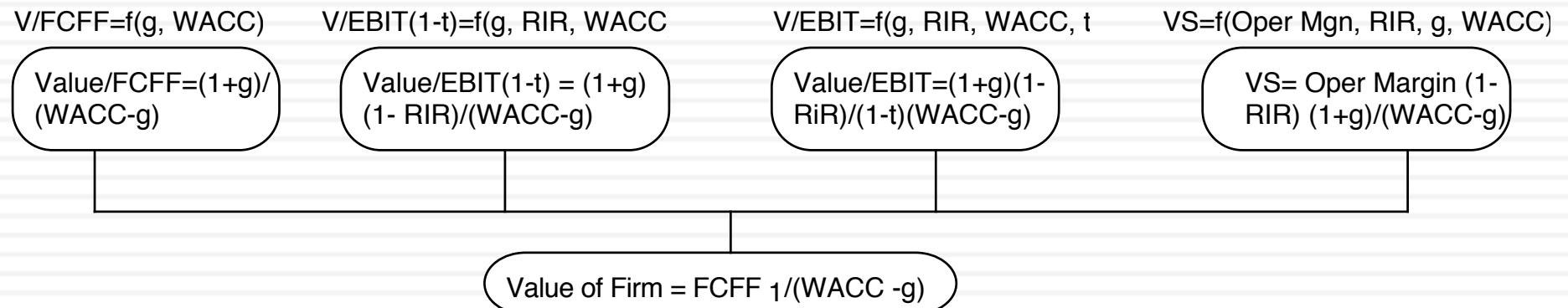

Application Tests

- Given the firm that you are valuing, what is a “comparable” firm?
 - While traditional analysis is built on the premise that firms in the same sector are comparable firms, valuation theory would suggest that a comparable firm is one which is similar to the one being analyzed in terms of fundamentals.
 - Proposition 4: There is no reason why a firm cannot be compared with another firm in a very different business, if the two firms have the same risk, growth and cash flow characteristics.
- Given the comparable firms, how do you adjust for differences across firms on the fundamentals?
 - Proposition 5: It is impossible to find an exactly identical firm to the one you are valuing.

An Example: Comparing PE Ratios across a Sector: PE

<i>Company Name</i>	<i>PE</i>	<i>Growth</i>
<i>PT Indosat ADR</i>	<i>7.8</i>	<i>0.06</i>
<i>Telebras ADR</i>	<i>8.9</i>	<i>0.075</i>
<i>Telecom Corporation of New Zealand ADR</i>	<i>11.2</i>	<i>0.11</i>
<i>Telecom Argentina Stet - France Telecom SA ADR B</i>	<i>12.5</i>	<i>0.08</i>
<i>Hellenic Telecommunication Organization SA ADR</i>	<i>12.8</i>	<i>0.12</i>
<i>Telecomunicaciones de Chile ADR</i>	<i>16.6</i>	<i>0.08</i>
<i>Swisscom AG ADR</i>	<i>18.3</i>	<i>0.11</i>
<i>Asia Satellite Telecom Holdings ADR</i>	<i>19.6</i>	<i>0.16</i>
<i>Portugal Telecom SA ADR</i>	<i>20.8</i>	<i>0.13</i>
<i>Telefonos de Mexico ADR L</i>	<i>21.1</i>	<i>0.14</i>
<i>Matav RT ADR</i>	<i>21.5</i>	<i>0.22</i>
<i>Telstra ADR</i>	<i>21.7</i>	<i>0.12</i>
<i>Gilat Communications</i>	<i>22.7</i>	<i>0.31</i>
<i>Deutsche Telekom AG ADR</i>	<i>24.6</i>	<i>0.11</i>
<i>British Telecommunications PLC ADR</i>	<i>25.7</i>	<i>0.07</i>
<i>Tele Danmark AS ADR</i>	<i>27</i>	<i>0.09</i>
<i>Telekomunikasi Indonesia ADR</i>	<i>28.4</i>	<i>0.32</i>
<i>Cable & Wireless PLC ADR</i>	<i>29.8</i>	<i>0.14</i>
<i>APT Satellite Holdings ADR</i>	<i>31</i>	<i>0.33</i>
<i>Telefonica SA ADR</i>	<i>32.5</i>	<i>0.18</i>
<i>Royal KPN NV ADR</i>	<i>35.7</i>	<i>0.13</i>
<i>Telecom Italia SPA ADR</i>	<i>42.2</i>	<i>0.14</i>
<i>Nippon Telegraph & Telephone ADR</i>	<i>44.3</i>	<i>0.2</i>
<i>France Telecom SA ADR</i>	<i>45.2</i>	<i>0.19</i>
<i>Korea Telecom ADR</i>	<i>71.3</i>	<i>0.44</i>

Henkel: A Relative Valuation

Company Name	Exchange: Ticker	PE	PBV	EV/Sales	EV/EBITDA	EV/ Invested Capital
The Procter & Gamble Company	NYSE:PG	21.14	3.81	3.73	13.96	3.20
Colgate-Palmolive Co.	NYSE:CL	45.20	NA	4.45	15.89	NA
Reckitt Benckiser Group plc	LSE:RB.	29.87	6.47	5.31	18.21	5.38
Henkel AG & Co. KGaA	DB:HEN3	22.88	3.38	2.54	13.66	3.46
Kimberly-Clark Corporation	NYSE:KMB	20.46	136.45	2.63	11.53	6.72
Svenska Cellulosa Aktiebolaget SCA	OM:SCA B	31.56	2.52	1.79	10.88	2.04
The Clorox Company	NYSE:CLX	23.73	51.77	3.00	14.42	7.80
Church & Dwight Co. Inc.	NYSE:CHD	26.85	6.06	3.77	15.96	4.53
Spectrum Brands Holdings, Inc.	NYSE:SPB	27.37	4.58	2.33	13.54	2.15
HRG Group, Inc.	NYSE:HRG	NA	5.48	1.87	9.01	1.60
Energizer Holdings, Inc.	NYSE:ENR	23.42	NA	2.16	11.83	NA
PZ Cussons Plc	LSE:PZC	18.03	2.42	1.68	10.88	2.13
WD-40 Company	NasdaqGS:WDFC	28.86	10.81	4.02	19.68	9.95
Central Garden & Pet Company	NasdaqGS:CEN	26.86	2.21	0.88	9.63	1.74
McBride plc	LSE:MCB	18.93	4.70	0.60	7.70	2.55
Orchids Paper Products Company	AMEX:TIS	16.66	2.01	2.10	10.52	1.59
Oil-Dri Corp. of America	NYSE:ODC	17.80	2.09	0.87	8.29	2.24
Suominen Oyj	HLSE:SUY1V	11.69	1.43	0.52	4.78	1.32
Accrol Group Holdings Plc	AIM:ACRL	17.74	NA	1.28	9.29	NA
Median		23.15	4.20	2.16	11.53	2.39
Henkel versus Median (Under or Over)		-1.16%	-19.54%	17.57%	18.45%	44.70%

Henkel: Controlling for differences

Company Name	Operating Margin	Net Margin	ROIC	ROE	Net Debt/Market Cap	Expected Growth in EPS	Revenue CAGR (Last 5 years)
The Procter & Gamble Company	22.00%	16.27%	14.23%	18.02%	7.60%	6.30%	-4.57%
Colgate-Palmolive Co.	25.17%	9.04%	53.52%	NA	8.40%	6.93%	-0.75%
Reckitt Benckiser Group plc	27.45%	17.17%	21.34%	21.67%	3.79%	11.00%	0.17%
Henkel AG & Co. KGaA	16.11%	11.15%	16.66%	14.75%	-0.91%	8.96%	3.17%
Kimberly-Clark Corporation	18.92%	10.96%	33.53%	666.89%	16.74%	7.20%	-2.59%
Svenska Cellulosa Aktiebolaget SCA	11.20%	4.62%	7.49%	8.00%	20.54%	8.04%	10.80%
The Clorox Company	18.23%	11.25%	31.23%	218.18%	12.48%	7.05%	1.95%
Church & Dwight Co. Inc.	20.64%	13.12%	16.21%	22.57%	7.15%	9.41%	5.64%
Spectrum Brands Holdings, Inc.	13.58%	5.78%	9.72%	16.74%	46.63%	12.20%	10.10%
HRG Group, Inc.	16.19%	-6.49%	9.37%	-60.24%	179.41%	0.00%	13.00%
Energizer Holdings, Inc.	15.97%	8.07%	45.82%	NA	14.16%	5.77%	NA
PZ Cussons Plc	12.82%	8.24%	13.49%	13.44%	12.05%	0.00%	0.01%
WD-40 Company	18.73%	13.82%	33.50%	37.46%	0.89%	10.00%	2.50%
Central Garden & Pet Company	6.80%	2.54%	8.73%	8.24%	28.87%	11.00%	2.42%
McBride plc	5.03%	2.50%	14.15%	24.81%	28.23%	0.00%	-3.47%
Orchids Paper Products Company	12.85%	9.32%	6.48%	12.09%	35.53%	14.30%	13.60%
Oil-Dri Corp. of America	5.87%	5.18%	14.29%	11.76%	-5.53%	0.00%	2.96%
Suominen Oyj	6.71%	3.69%	11.07%	12.19%	21.64%	-0.20%	19.80%
Accrol Group Holdings Plc	10.52%	4.83%	NA	NA	NA	0.00%	NA
Median	15.97%	8.24%	14.26%	15.75%	13.32%	7.05%	2.50%
Henkel versus Median (Under or Over)	0.84%	35.37%	16.81%	-6.32%	-106.83%	27.09%	26.80%

Comparisons to the entire market: Why not?

- In contrast to the 'comparable firm' approach, the information in the entire cross-section of firms can be used to predict PE ratios.
- The simplest way of summarizing this information is with a multiple regression, with the PE ratio as the dependent variable, and proxies for risk, growth and payout forming the independent variables.

PE Ratio: Standard Regression for US stocks - January 2017

196

Model Summary^a

Model	R	R Square	Adjusted R Square	Std. Error of the Estimate
1	.653 ^b	.427	.426	2275.70504

a. Broad Group = United States

b. Predictors: (Constant), Payout Ratio, Beta, Expected growth rate in EPS- Next 5 years

The regression is run with growth and payout entered as decimals, i.e., 25% is entered as 0.25)

Coefficients^{a,b,c}

Model		Unstandardized Coefficients		Standardized Coefficients	t	Sig.
		B	Std. Error	Beta		
1	(Constant)	-3.945	1.838		-2.146	.032
	Beta	3.527	1.607	.043	2.194	.028
	Expected growth rate in EPS- Next 5 years	174.025	5.490	.633	31.699	.000
	Payout Ratio	20.584	1.045	.399	19.692	.000

a. Broad Group = United States

b. Dependent Variable: Trailing PE

c. Weighted Least Squares Regression - Weighted by Market Cap (in US \$)

PE ratio regressions across markets – January 2017

197

Region	Regression – January 2017	R ²
US	PE = 170.55 g_{EPS} + 19.43 Payout – 0.62 Beta	42.6%
Europe	PE = 13.89 + 21.42 g_{EPS} + 14.90 Payout – 2.44 Beta	25.1%
Japan	PE = 5.82+ 46.38 g_{EPS} + 28.73 Payout – 1.52 Beta	32.7%
Emerging Markets	PE = 14.59 + 20.23 g_{EPS} + 10.88 Payout – 1.07 Beta	12.2%
Australia, NZ, Canada	PE = 8.85 + 52.08 g_{EPS} + 14.64 Payout (Beta not significant)	17.1%
Global	PE = 15.21 + 48.98 g_{EPS} + 14.01 Payout – 2.52 Beta	18.2%

g_{EPS} = Expected Growth: Expected growth in EPS or Net Income: Next 5 years

Beta: Regression or Bottom up Beta

Payout ratio: Dividends/ Net income from most recent year. Set to zero, if net income < 0

Choosing Between the Multiples

- As presented in this section, there are dozens of multiples that can be potentially used to value an individual firm.
- In addition, relative valuation can be relative to a sector (or comparable firms) or to the entire market (using the regressions, for instance)
- Since there can be only one final estimate of value, there are three choices at this stage:
 - Use a simple average of the valuations obtained using a number of different multiples
 - Use a weighted average of the valuations obtained using a number of different multiples
 - Choose one of the multiples and base your valuation on that multiple

Picking one Multiple

- This is usually the best way to approach this issue. While a range of values can be obtained from a number of multiples, the “best estimate” value is obtained using one multiple.
- The multiple that is used can be chosen in one of two ways:
 - Use the multiple that best fits your objective. Thus, if you want the company to be undervalued, you pick the multiple that yields the highest value.
 - Use the multiple that has the highest R-squared in the sector when regressed against fundamentals. Thus, if you have tried PE, PBV, PS, etc. and run regressions of these multiples against fundamentals, use the multiple that works best at explaining differences across firms in that sector.
 - Use the multiple that seems to make the most sense for that sector, given how value is measured and created.

Conventional usage...

Sector	Multiple Used	Rationale
Cyclical Manufacturing	PE, Relative PE	Often with normalized earnings
Growth firms	PEG ratio	Big differences in growth rates
Young growth firms w/ losses	Revenue Multiples	What choice do you have?
Infrastructure	EV/EBITDA	Early losses, big DA
REIT	P/CFE (where CFE = Net income + Depreciation)	Big depreciation charges on real estate
Financial Services	Price/ Book equity	Marked to market?
Retailing	Revenue multiples	Margins equalize sooner or later

A closing thought...

