

Aswath Damodaran



VALUATION

Aswath Damodaran
www.damodaran.com

Some Initial Thoughts

" One hundred thousand lemmings cannot be wrong"

Graffiti

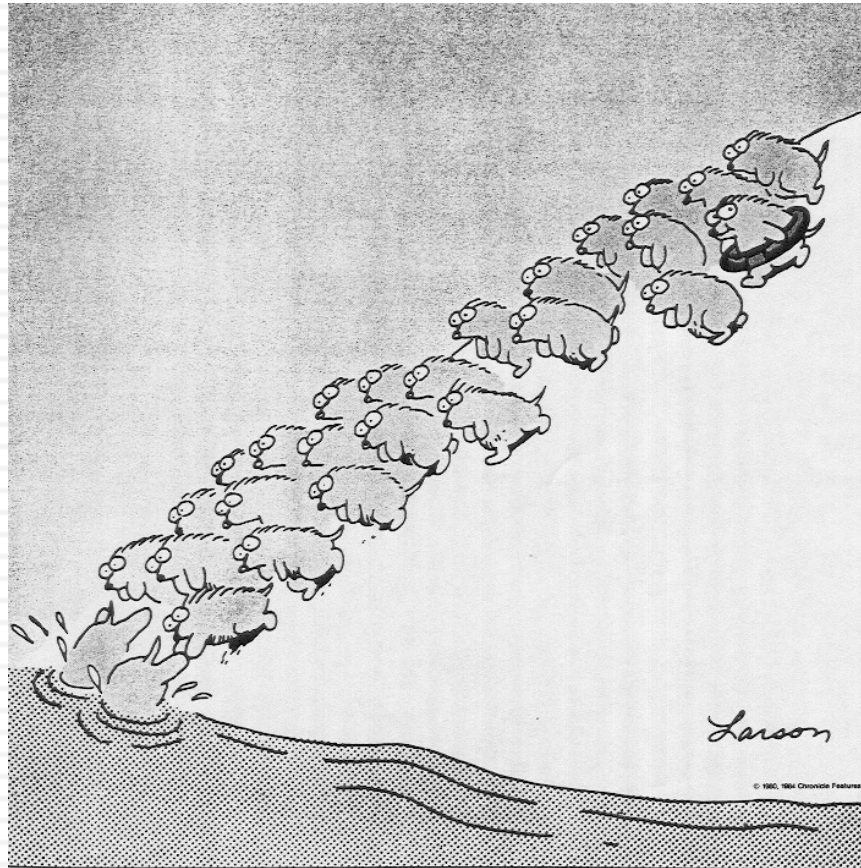

Aswath Damodaran

Theme 1: Characterizing Valuation as a discipline

- In a science, if you get the inputs right, you should get the output right. The laws of physics and mathematics are universal and there are no exceptions. **Valuation is not a science.**
- In an art, there are elements that can be taught but there is also a magic that you either have or you do not. The essence of an art is that you are either a great artist or you are not. **Valuation is not an art.**
- A craft is a skill that you learn by doing. The more you do it, the better you get at it. **Valuation is a craft.**

Theme 2: Valuing an asset is not the same as pricing that asset

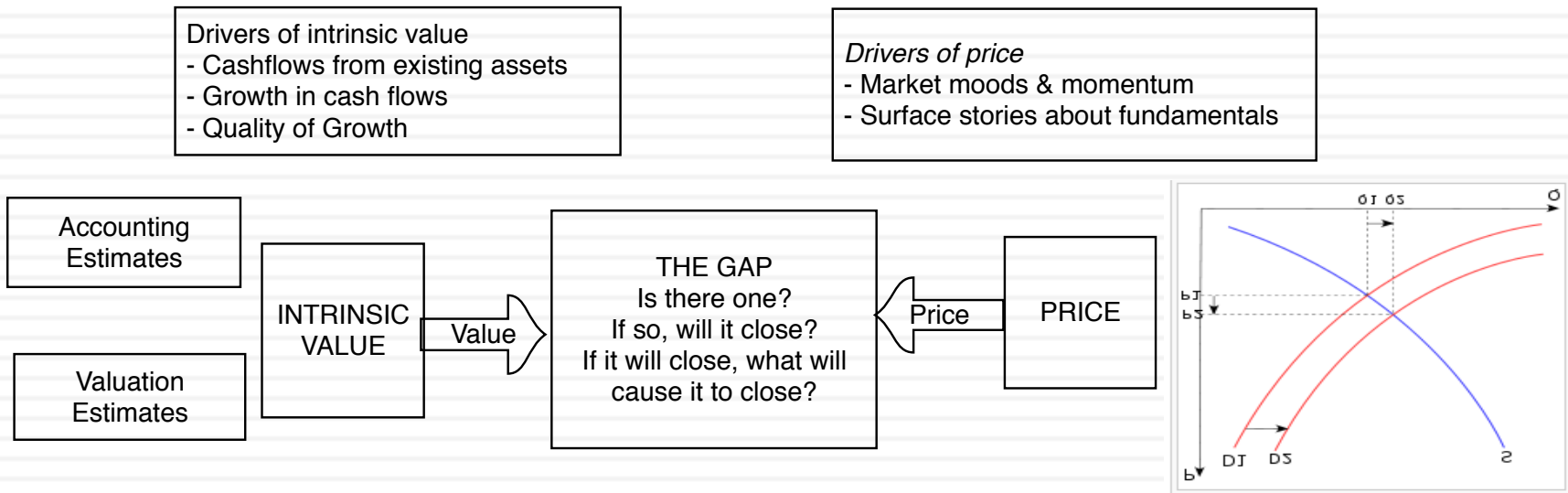

Theme 3: Good valuation = Story + Numbers

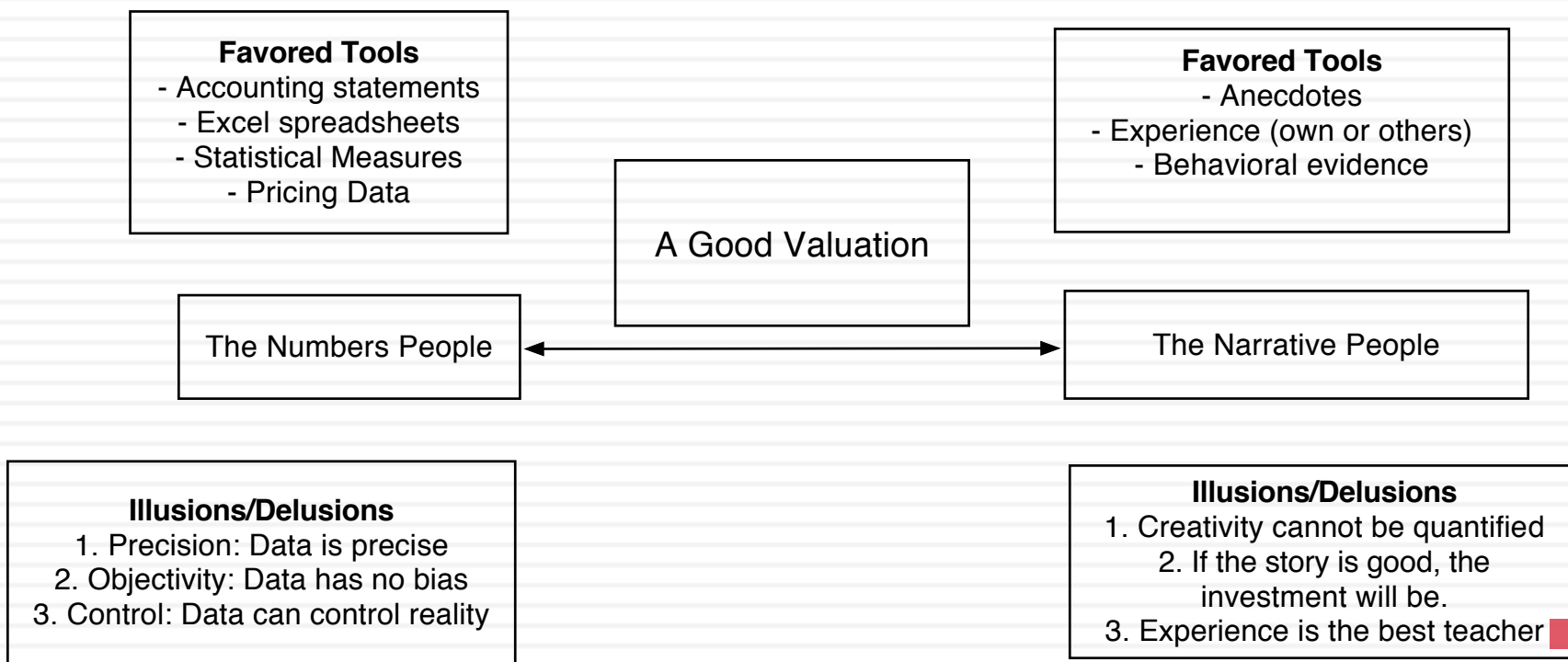

Theme 4: If you value something, you should be willing to act on it..

- There is very little theory in valuation and I am not sure what an academic valuation would like like and am not sure that I want to find out.
- Pragmatism, not purity: The end game is to estimate a value for an asset. I plan to get there, even if it means taking short cuts and making assumptions that would make purists blanch.
- To act on your valuations, you have to have faith in
 - ▣ In your own valuation judgments.
 - ▣ In markets: that prices will move towards your value estimates.That faith will have to be earned.

Misconceptions about Valuation

- Myth 1: A valuation is an objective search for “true” value
 - ▣ Truth 1.1: All valuations are biased. The only questions are how much and in which direction.
 - ▣ Truth 1.2: The direction and magnitude of the bias in your valuation is directly proportional to who pays you and how much you are paid.
- Myth 2.: A good valuation provides a precise estimate of value
 - ▣ Truth 2.1: There are no precise valuations
 - ▣ Truth 2.2: The payoff to valuation is greatest when valuation is least precise.
- Myth 3: . The more quantitative a model, the better the valuation
 - ▣ Truth 3.1: One’ s understanding of a valuation model is inversely proportional to the number of inputs required for the model.
 - ▣ Truth 3.2: Simpler valuation models do much better than complex ones.

Approaches to Valuation

- **Intrinsic valuation**, relates the value of an asset to the present value of expected future cashflows on that asset. In its most common form, this takes the form of a discounted cash flow valuation.
- **Relative valuation**, estimates the value of an asset by looking at the pricing of 'comparable' assets relative to a common variable like earnings, cash flows, book value or sales.
- **Contingent claim valuation**, uses option pricing models to measure the value of assets that share option characteristics.

Discounted Cash Flow Valuation

- *What is it:* In discounted cash flow valuation, the value of an asset is the present value of the expected cash flows on the asset.
- *Philosophical Basis:* Every asset has an intrinsic value that can be estimated, based upon its characteristics in terms of cash flows, growth and risk.
- *Information Needed:* To use discounted cash flow valuation, you need
 - to estimate the life of the asset
 - to estimate the cash flows during the life of the asset
 - to estimate the discount rate to apply to these cash flows to get present value
- *Market Inefficiency:* Markets are assumed to make mistakes in pricing assets across time, and are assumed to correct themselves over time, as new information comes out about assets.

Risk Adjusted Value: Three Basic Propositions

- The value of a risky asset can be estimated by discounting the expected cash flows on the asset over its life at a risk-adjusted discount rate:

$$\text{Value of asset} = \frac{E(\text{CF}_1)}{(1+r)} + \frac{E(\text{CF}_2)}{(1+r)^2} + \frac{E(\text{CF}_3)}{(1+r)^3} \dots + \frac{E(\text{CF}_n)}{(1+r)^n}$$

1. *The IT Proposition:* If “it” does not affect the cash flows or alter risk (thus changing discount rates), “it” cannot affect value.
2. *The DUH Proposition:* For an asset to have value, the expected cash flows have to be positive some time over the life of the asset.
3. *The DON'T FREAK OUT Proposition:* Assets that generate cash flows early in their life will be worth more than assets that generate cash flows later; the latter may however have greater growth and higher cash flows to compensate.

DCF Choices: Equity Valuation versus Firm Valuation

Firm Valuation: Value the entire business

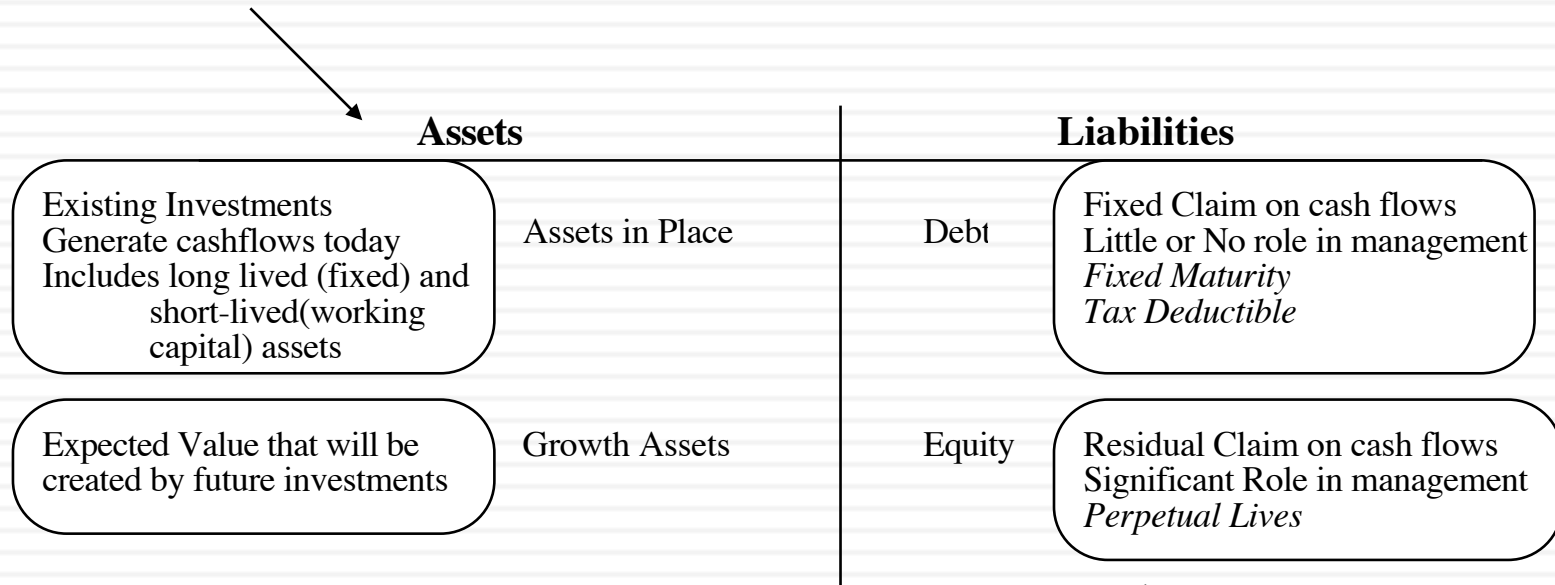

Equity valuation: Value just the equity claim in the business

The Drivers of Value...

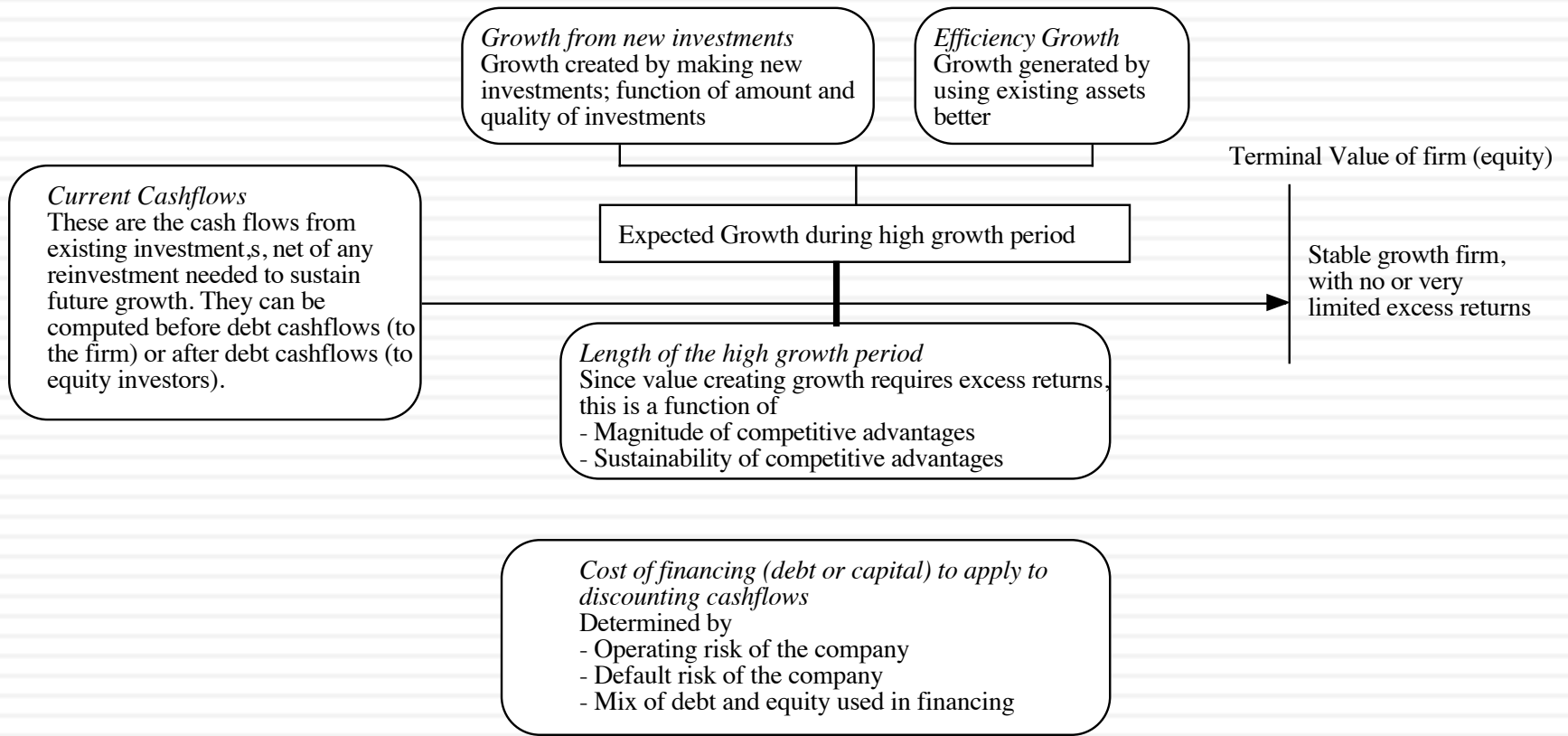

DISCOUNTED CASHFLOW VALUATION

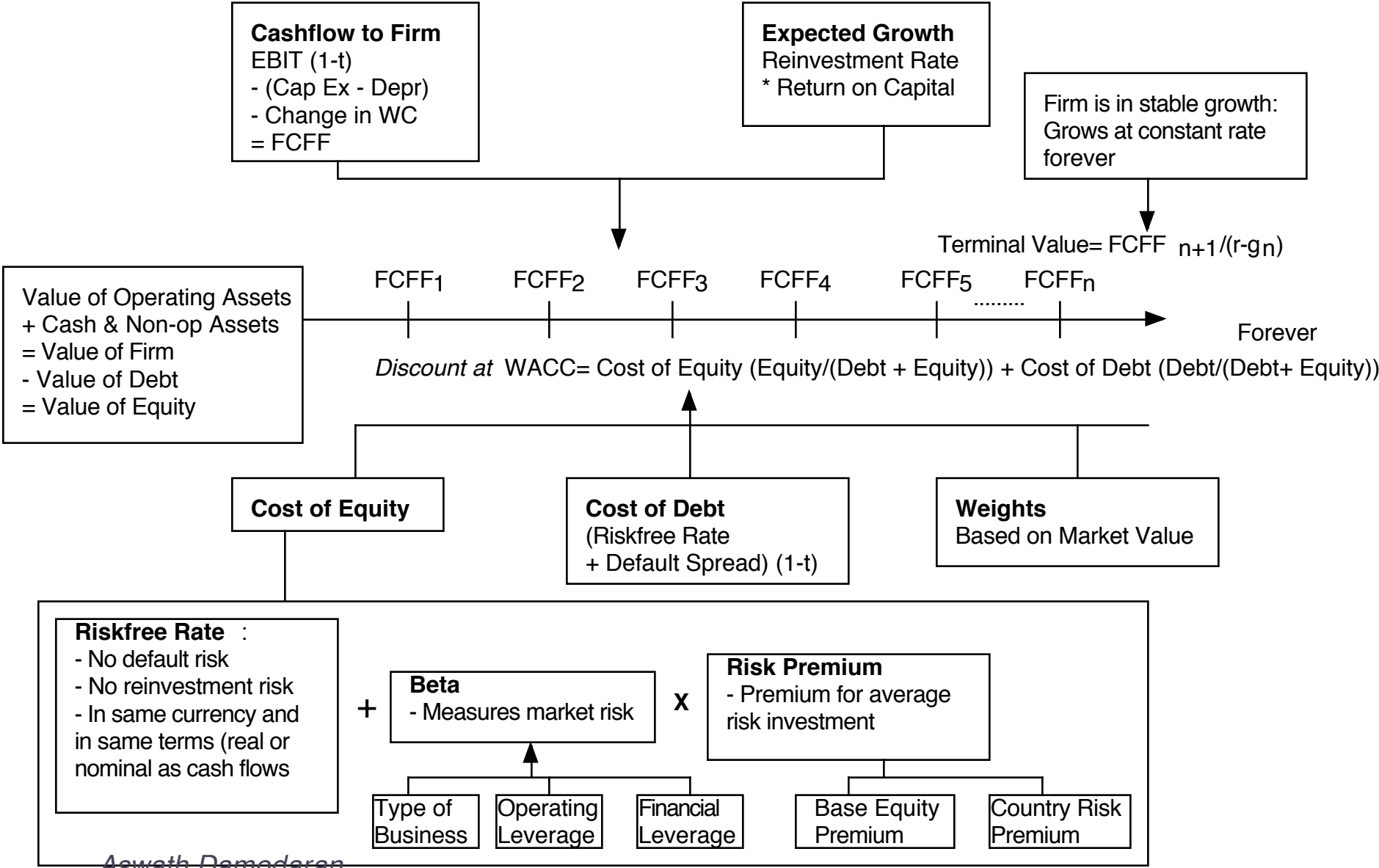

Amgen: Status Quo

Cap Ex = Acc net Cap Ex(255) + Acquisitions (3975) + R&D (2216)

Current Cashflow to Firm
 EBIT(1-t) = :7336(1-.28) = 6058
 - Nt CpX = 6443
 - Chg WC 37
 = FCFF - 423
 Reinvestment Rate = 6480/6058 = 106.98%
 Return on capital = 16.71%

Reinvestment Rate 60%

Expected Growth in EBIT (1-t)
 $.60 * .16 = .096$
9.6%

Return on Capital 16%

Stable Growth
 g = 4%; Beta = 1.10;
 Debt Ratio = 20%; Tax rate = 35%
 Cost of capital = 8.08%
 ROC = 10.00%;
 Reinvestment Rate = 4/10 = 40%

Terminal Value₁₀ = 7300 / (.0808 - .04) = 179,099

First 5 years

Growth decreases gradually to 4%

Op. Assets 94214
 + Cash: 1283
 - Debt 8272
 = Equity 87226
 - Options 479
 Value/Share \$ 74.33

| Year | 1 | 2 | 3 | 4 | 5 | 6 | 7 | 8 | 9 | 10 |
|----------------|---------|----------|----------|----------|----------|----------|----------|----------|----------|----------|
| EBIT | \$9,221 | \$10,106 | \$11,076 | \$12,140 | \$13,305 | \$14,433 | \$15,496 | \$16,463 | \$17,306 | \$17,998 |
| EBIT (1-t) | \$6,639 | \$7,276 | \$7,975 | \$8,741 | \$9,580 | \$10,392 | \$11,157 | \$11,853 | \$12,460 | \$12,958 |
| - Reinvestment | \$3,983 | \$4,366 | \$4,785 | \$5,244 | \$5,748 | \$5,820 | \$5,802 | \$5,690 | \$5,482 | \$5,183 |
| = FCFF | \$2,656 | \$2,911 | \$3,190 | \$3,496 | \$3,832 | \$4,573 | \$5,355 | \$6,164 | \$6,978 | \$7,775 |

Term Yr
 18718
 12167
 4867
 7300

Cost of Capital (WACC) = 11.7% (0.90) + 3.66% (0.10) = 10.90%

Debt ratio increases to 20%
 Beta decreases to 1.10

On May 1, 2007, Amgen was trading at \$ 55/share

Cost of Equity 11.70%

Cost of Debt
 $(4.78\% + .85\%)(1-.35)$
 = 3.66%

Weights
 E = 90% D = 10%

Riskfree Rate:
 Riskfree rate = 4.78%

+ **Beta 1.73** x **Risk Premium 4%**

Unlevered Beta for Sectors: 1.59

D/E = 11.06%

Aswath Damodaran

Tata Motors: April 2010

Current Cashflow to Firm

| | |
|--------------|--------------------|
| EBIT(1-t) : | Rs 20,116 |
| - Nt CpX | Rs 31,590 |
| - Chg WC | Rs 2,732 |
| = FCFF | - Rs 14,205 |
| Reinv Rate = | 170.61% |
| Tax rate = | 21%; ROIC = 17.16% |

Average reinvestment rate from 2005-09: 179.59%; without acquisitions: 70%

Reinvestment Rate = 70%

Expected Growth from new inv.
 $.70 \times .1716 = 0.1201$

Return on Capital 17.16%

Stable Growth
 g = 5%; Beta = 1.00
 Country Premium = 3%
 Cost of capital = 10.39%
 Tax rate = 33.99%
 ROC = 12%;
 Reinvestment Rate = $g/ROC = 5\%/12\% = 41.67\%$

Return on capital = 17.16%

Rs Cashflows

Terminal Value₅ = $26412 / (.1039 - .05) = \text{Rs } 489,813$

| | |
|---------------|---------|
| Op. Assets | 231,914 |
| + Cash: | 11418 |
| + Cross Hold. | 140576 |
| - Debt | 109198 |
| = Equity | 274,710 |
| Value/Share | Rs 614 |

| Year | 1 | 2 | 3 | 4 | 5 | 6 | 7 | 8 | 9 | 10 |
|----------------|-------|-------|-------|-------|-------|-------|-------|-------|-------|-------|
| EBIT (1-t) | 22533 | 25240 | 28272 | 31668 | 35472 | 39236 | 42848 | 46192 | 49150 | 51607 |
| - Reinvestment | 15773 | 17668 | 19790 | 22168 | 24830 | 25242 | 25138 | 24482 | 23264 | 21503 |
| FCFF | 6760 | 7572 | 8482 | 9500 | 10642 | 13994 | 17711 | 21710 | 25886 | 30104 |

45278
18866
26412

Discount at \$ Cost of Capital (WACC) = 14.00% (.747) + 8.09% (0.253) = 12.50%

Growth declines to 5% and cost of capital moves to stable period level.

On April 1, 2010
Tata Motors price = Rs 781

Cost of Equity
14.00%

Cost of Debt
 $(5\% + 4.25\% + 3\%)(1 - .3399) = 8.09\%$

Weights
E = 74.7% D = 25.3%

Riskfree Rate:
Rs Riskfree Rate = 5%

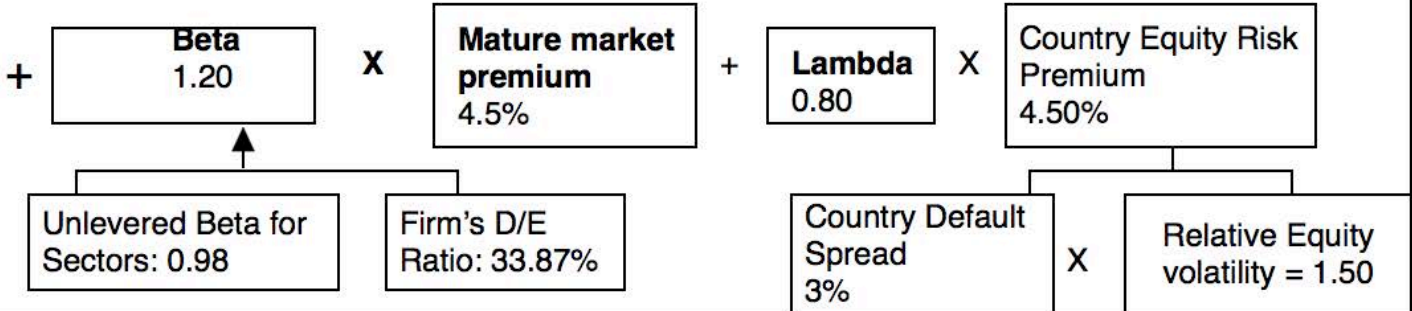

Indofood's revenue growth has been sluggish and its margin decreased slightly in 2015

| | Company | Industry |
|------------------|---------|----------|
| Revenue growth | 2.46% | 7.62% |
| Operating margin | 11.26% | 8.38% |
| Sales to capital | 1.12 | 1.75 |
| ROIC | 9.23% | 12.28% |

Indofood: My valuation (July 2016)

Between 2008 and 2015, Indofoods reported a growth rate of 11.37% in revenues, an average operating margin of 12.6% and an average sales to capital ratio of 1.83.

Stable Growth
 $g = 5.04\%$
 Cost of capital = 9.54%
 ROC = 9.54%;
 Reinvestment Rate = $5.04\%/9.54\% = 52.83\%$

Revenue growth of 11.37% a year for 5 years, tapering down to 5.04% in year 10

Pre-tax operating margin increases to 12.6% over time.

Sales to capital ratio of 1.83 for incremental sales

Terminal Value = $7570 / (.0954 - .0504) = 168,226$

| | Base year | 1 | 2 | 3 | 4 | 5 | 6 | 7 | 8 | 9 | 10 | Terminal year |
|-------------------------|--------------|--------------|--------------|---------------|---------------|---------------|---------------|---------------|---------------|---------------|---------------|---------------|
| Revenue growth rate | | 11.37% | 11.37% | 11.37% | 11.37% | 11.37% | 10.10% | 8.84% | 7.57% | 6.31% | 5.04% | 5.04% |
| Revenues | IDR65,557 | IDR73,011 | IDR81,312 | IDR90,557 | IDR100,854 | IDR112,321 | IDR123,670 | IDR134,600 | IDR144,791 | IDR153,922 | IDR161,680 | IDR169,828 |
| EBIT (Operating) margin | 11.26% | 11.40% | 11.53% | 11.66% | 11.80% | 11.93% | 12.06% | 12.20% | 12.33% | 12.47% | 12.60% | 12.60% |
| EBIT (Operating income) | IDR 7,383.00 | IDR 8,320.14 | IDR 9,374.94 | IDR 10,562.04 | IDR 11,897.89 | IDR 13,400.97 | IDR 14,920.48 | IDR 16,419.25 | IDR 17,856.25 | IDR 19,188.22 | IDR 20,371.64 | IDR 21,398.38 |
| Tax rate | 27.05% | 27.05% | 27.05% | 27.05% | 27.05% | 27.05% | 26.64% | 26.23% | 25.82% | 25.41% | 25.00% | 25.00% |
| EBIT(1-t) | IDR5,386 | IDR6,070 | IDR6,839 | IDR7,705 | IDR8,680 | IDR9,776 | IDR10,946 | IDR12,112 | IDR13,246 | IDR14,312 | IDR15,279 | IDR16,049 |
| - Reinvestment | | IDR4,073 | IDR4,536 | IDR5,052 | IDR5,626 | IDR6,266 | IDR6,202 | IDR5,973 | IDR5,569 | IDR4,989 | IDR4,239 | IDR8,479 |
| FCFF | | IDR1,996 | IDR2,303 | IDR2,653 | IDR3,053 | IDR3,510 | IDR4,744 | IDR6,140 | IDR7,676 | IDR9,323 | IDR11,040 | IDR7,570 |
| Cost of capital | | 11.63% | 11.63% | 11.63% | 11.63% | 11.63% | 11.21% | 10.79% | 10.37% | 9.96% | 9.54% | 9.54% |
| PV(FCFF) | | IDR1,788 | IDR1,848 | IDR1,907 | IDR1,966 | IDR2,025 | IDR2,461 | IDR2,875 | IDR3,257 | IDR3,597 | IDR3,889 | |

| | |
|---------------------------------|-----------|
| Value of operating assets = | IDR84,875 |
| - Debt | IDR27,793 |
| - Minority interests | IDR27 |
| + Cash | IDR13,913 |
| + Non-operating assets | IDR1,821 |
| Value of equity | IDR72,789 |
| - Value of options | IDR7,684 |
| Value of equity in common stock | IDR65,105 |
| Number of shares | 8.78 |
| Estimated value /share | IDR 7,415 |

Cost of capital = $13.76\% (.705) + 6.55\% (.295) = 11.63\%$

Cost of capital decreases to 9.54% from years 6-10

Cost of equity = 13.76%
 Cost of Debt *Rated Baa1* $(5.04\% + 2.44\% + 1.25\%)(1 - .25) = 6.55\%$
 Weights E = 70.5% D = 29.5%

On July 2, 2016, the shares were trading at 7000 IDR/share.

Riskfree Rate:
Riskfree rate = 5.04%

Beta
0.95

Risk Premium
9.18%

D/E = 41.93%

| Business | Weight | Unlevered Beta |
|---------------------|--------|----------------|
| Food Processing | 81.37% | 0.72 |
| Food Wholesalers | 1.99% | 0.49 |
| Farming/Agriculture | 16.63% | 0.76 |
| Indofood | | 0.72 |

| Country | ERP | Weight |
|-------------------|--------|---------|
| Indonesia | 9.28% | 91.17% |
| Saudi Arabia | 6.90% | 1.45% |
| Vietnam | 12.71% | 0.93% |
| Nigeria | 11.37% | 0.79% |
| Singapore | 6.00% | 0.67% |
| Korea | 6.74% | 0.50% |
| Thailand | 8.38% | 0.48% |
| Rest of the World | 7.45% | 4.00% |
| Total | 9.18% | 100.00% |



DCF INPUTS

“Garbage in, garbage out”

I. Measure earnings right..

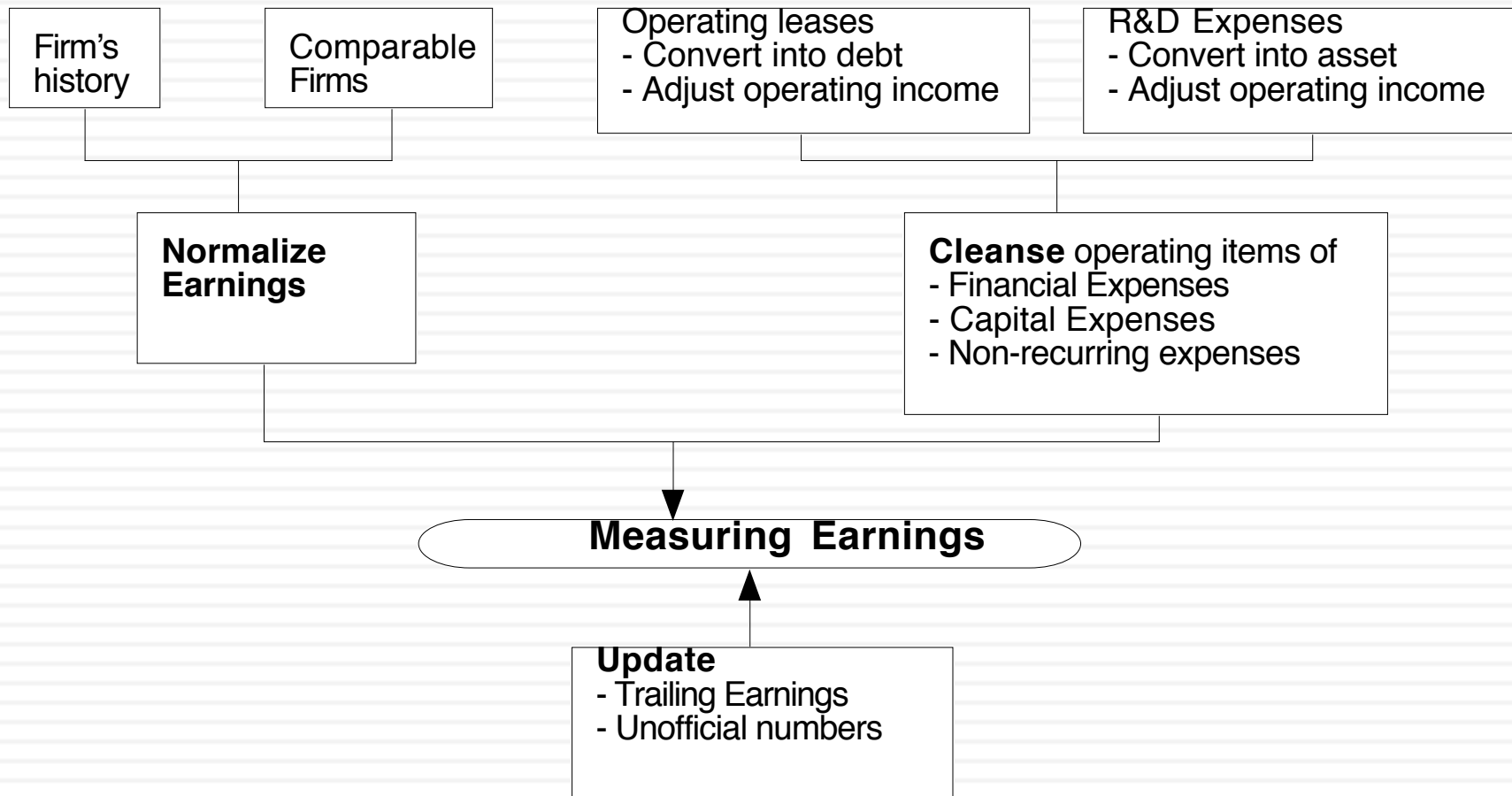

Operating Leases at Amgen in 2007

- Amgen has lease commitments and its cost of debt (based on its A rating) is 5.63%.

| Year | Commitment | Present Value |
|------|------------|-----------------------------------|
| 1 | \$96.00 | \$90.88 |
| 2 | \$95.00 | \$85.14 |
| 3 | \$102.00 | \$86.54 |
| 4 | \$98.00 | \$78.72 |
| 5 | \$87.00 | \$66.16 |
| 6-12 | \$107.43 | \$462.10 (\$752 million prorated) |

- Debt Value of leases = \$869.55
- Debt outstanding at Amgen = \$7,402 + \$ 870 = \$8,272 million
- Adjusted Operating Income = Stated OI + Lease expense this year – Depreciation
= 5,071 m + 69 m - 870/12 = \$5,068 million (12 year life for assets)
- Approximate Operating income= stated OI + PV of Lease commitment * Pre-tax cost of debt
= \$5,071 m + 870 m (.0563) = \$ 5,120 million

Capitalizing R&D Expenses: Amgen

- R & D was assumed to have a 10-year life.

| Year | R&D Expense | Unamortized portion | Amortization this year | |
|---------------------------|-------------|---------------------|------------------------|------------|
| Current | 3366.00 | 1.00 | 3366.00 | |
| -1 | 2314.00 | 0.90 | 2082.60 | \$231.40 |
| -2 | 2028.00 | 0.80 | 1622.40 | \$202.80 |
| -3 | 1655.00 | 0.70 | 1158.50 | \$165.50 |
| -4 | 1117.00 | 0.60 | 670.20 | \$111.70 |
| -5 | 865.00 | 0.50 | 432.50 | \$86.50 |
| -6 | 845.00 | 0.40 | 338.00 | \$84.50 |
| -7 | 823.00 | 0.30 | 246.90 | \$82.30 |
| -8 | 663.00 | 0.20 | 132.60 | \$66.30 |
| -9 | 631.00 | 0.10 | 63.10 | \$63.10 |
| -10 | 558.00 | 0.00 | 0.00 | \$55.80 |
| Value of Research Asset = | | | \$10,112.80 | \$1,149.90 |

- Adjusted Operating Income = $\$5,120 + 3,366 - 1,150 = \$7,336$ million

Indofood's Operating Earnings History

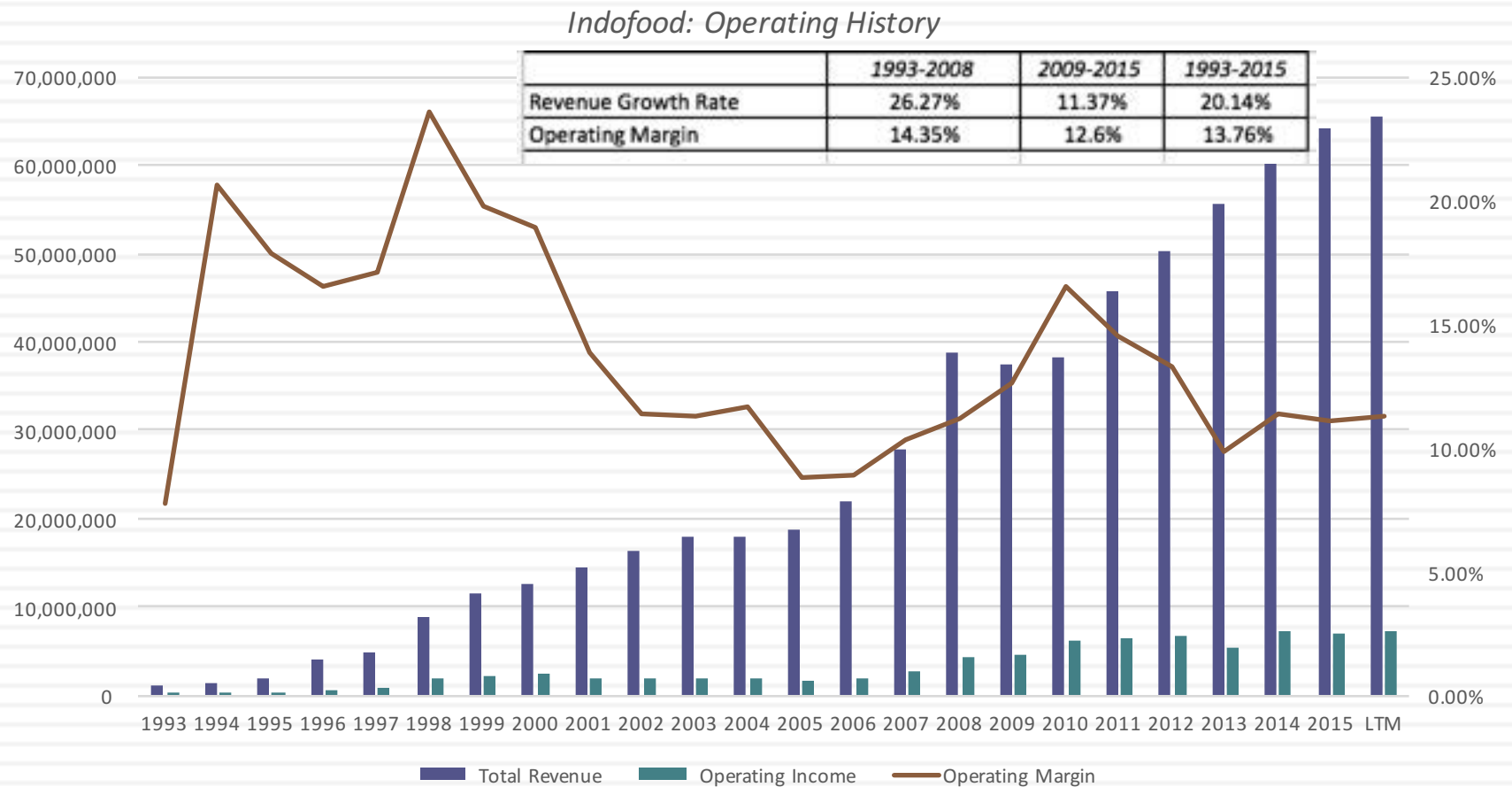

II. Get the big picture (not the accounting one) when it comes to cap ex and working capital

- Capital expenditures should include
 - Research and development expenses, once they have been re-categorized as capital expenses.
 - Acquisitions of other firms, whether paid for with cash or stock.
- Working capital should be defined not as the difference between current assets and current liabilities but as the difference between non-cash current assets and non-debt current liabilities.
- On both items, start with what the company did in the most recent year but do look at the company's history and at industry averages.

Amgen's Net Capital Expenditures

- The accounting net cap ex at Amgen is small:
 - ▣ Accounting Capital Expenditures = \$1,218 million
 - ▣ - Accounting Depreciation = \$ 963 million
 - ▣ Accounting Net Cap Ex = \$ 255 million
- We define capital expenditures broadly to include R&D and acquisitions:
 - ▣ Accounting Net Cap Ex = \$ 255 million
 - ▣ Net R&D Cap Ex = (3366-1150) = \$2,216 million
 - ▣ Acquisitions in 2006 = \$3,975 million
 - ▣ Total Net Capital Expenditures = \$ 6,443 million
- Acquisitions have been a volatile item. Amgen was quiet on the acquisition front in 2004 and 2005 and had a significant acquisition in 2003.

III. The government bond rate is not always the risk free rate

- When valuing Amgen in US dollars, the US\$ ten-year bond rate of 4.78% was used as the risk free rate. We assumed that the US treasury was default free.
- When valuing Tata Motors in Indian rupees in 2010, the Indian government bond rate of 8% was not default free. Using the Indian government's local currency rating of Ba2 yielded a default spread of 3% for India and a riskfree rate of 5% in Indian rupees.

$$\text{Risk free rate in Indian Rupees} = 8\% - 3\% = 5\%$$

- To value Indofoods, you need a risk free rate in Indonesian Rupiah. The Indonesian INR government bond rate on July 1, 2016 was 7.48%. The Indonesian government was rated Baa3 on that day with a default spread of 2.44% associated with it. The risk free rate in INR is:
 - ▣ Risk free Rate in INR = 7.48% - 2.44% = 5.04%

Risk free rates will vary across currencies!

Risk free Rates in Currencies: July 1, 2016

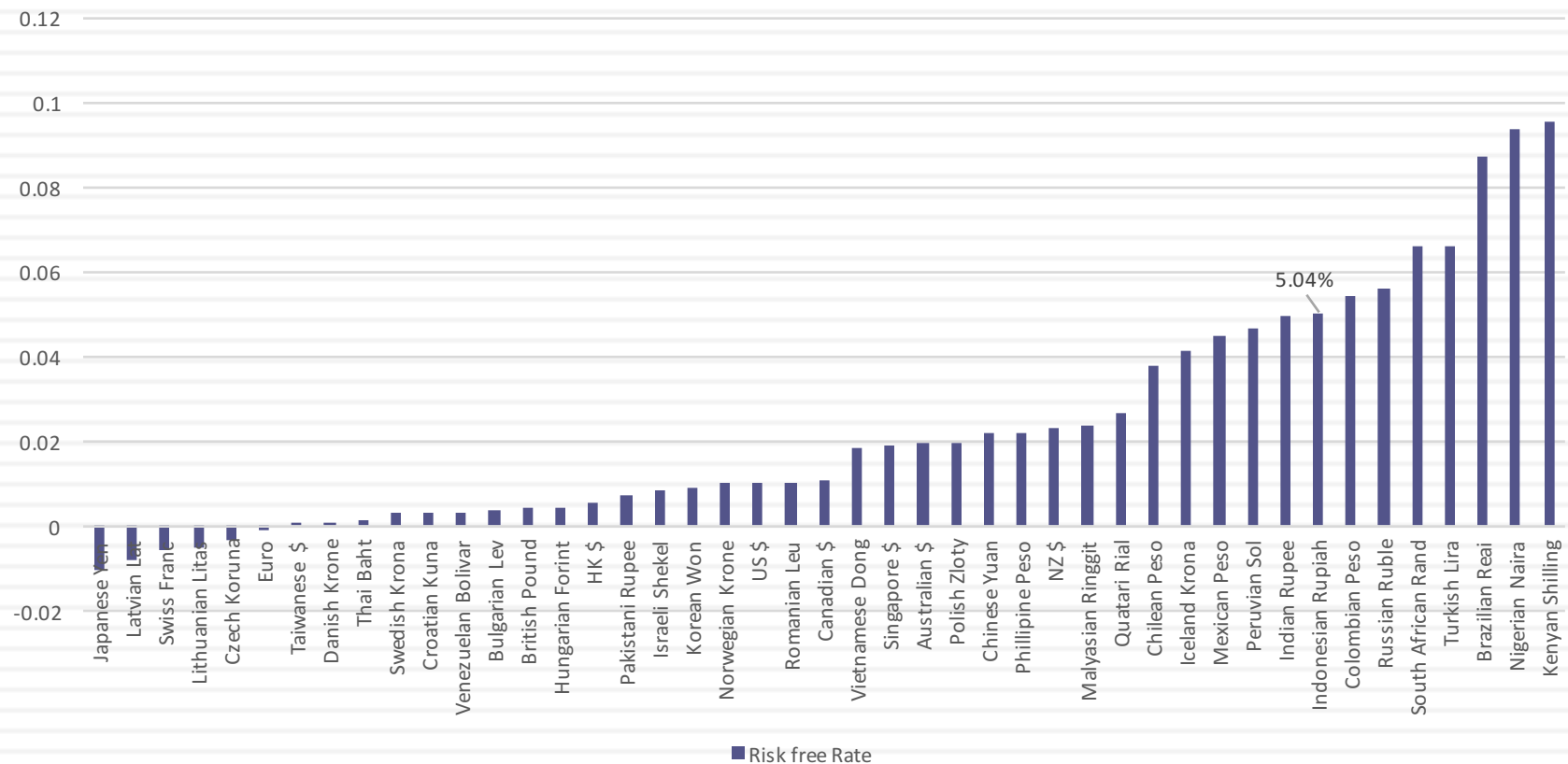

But valuations should not! Valuing Tata Motors

| | In Indian Rupees | In US \$ |
|-------------------------|------------------|---|
| Risk free Rate | 5.00% | 2.00% |
| Expected inflation rate | 4.00% | 1.00% |
| Cost of capital | | |
| - High Growth | 12.50% | 9.25% |
| - Stable Growth | 10.39% | 7.21% |
| Expected growth rate | | |
| - High Growth | 12.01% | 8.78% |
| - Stable Growth | 5.00% | 2.00% |
| Return on Capital | | |
| - High Growth | 17.16% | 13.78% |
| - Stable Growth | 10.39% | 7.21% |
| Value per share | Rs 614 | \$12.79/share (roughly Rs 614 at current exchange rate) |

IV. Betas do not come from regressions... and are noisy...

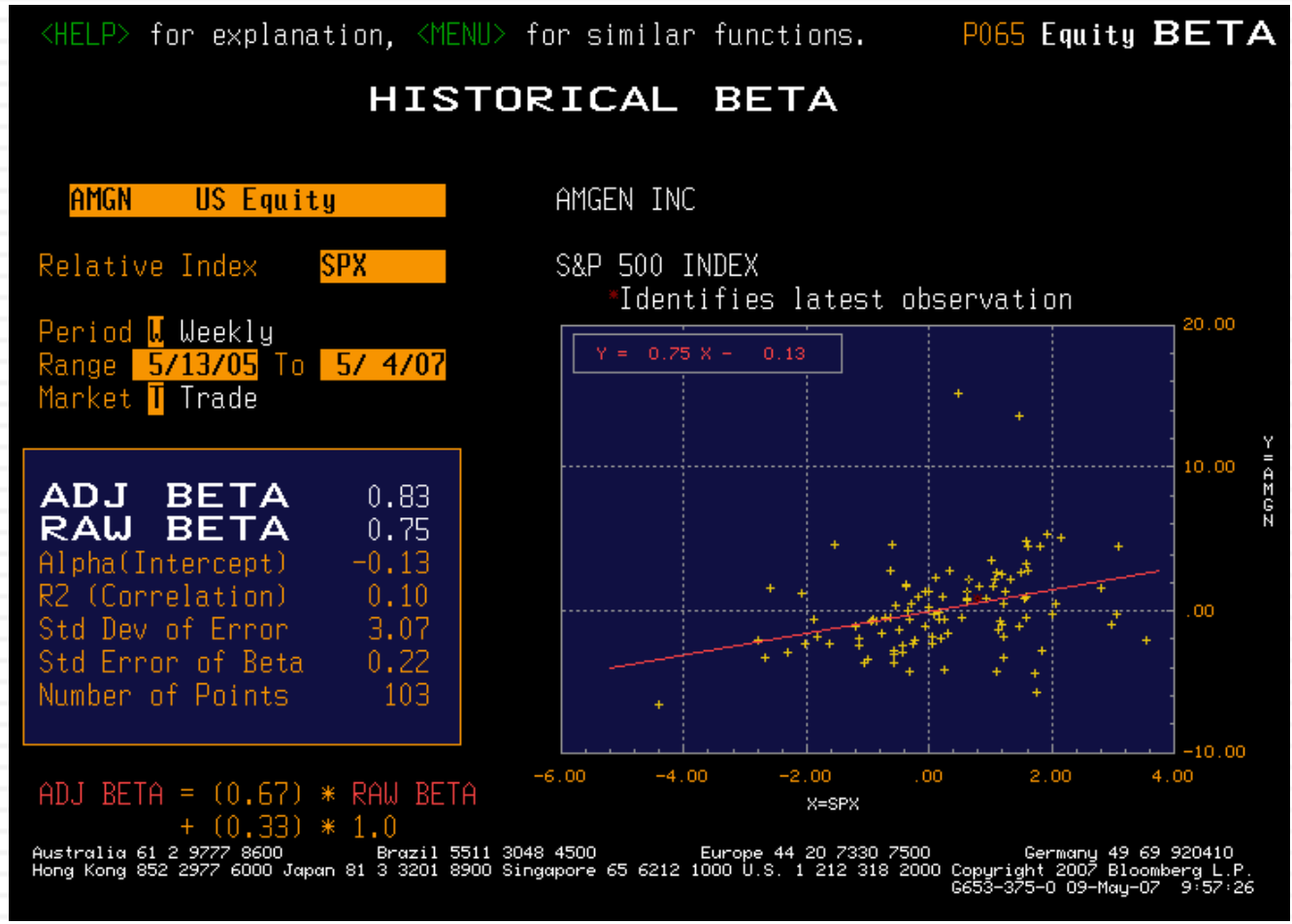

Look better for some companies, but not if run against narrow indices

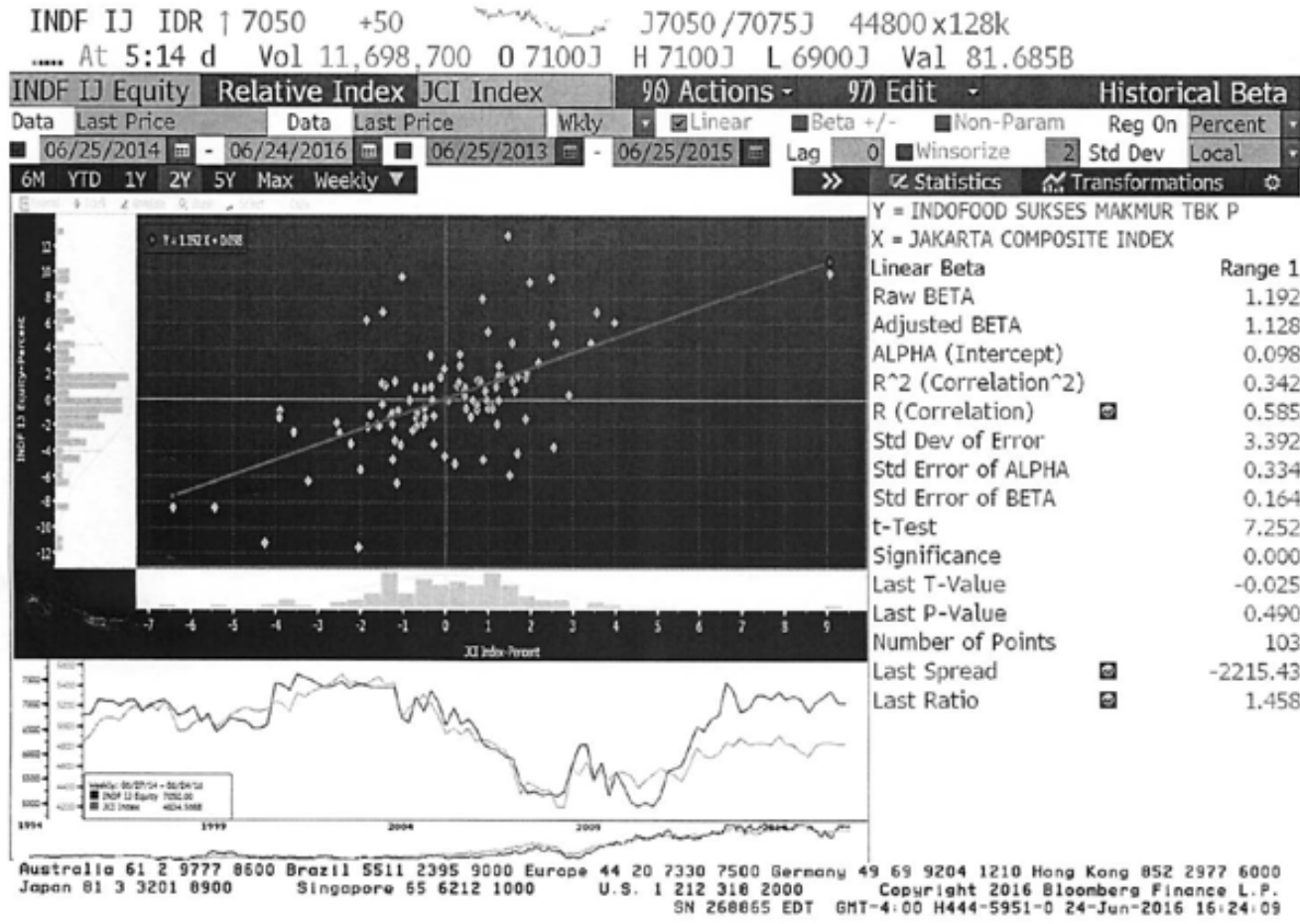

Determinants of Betas

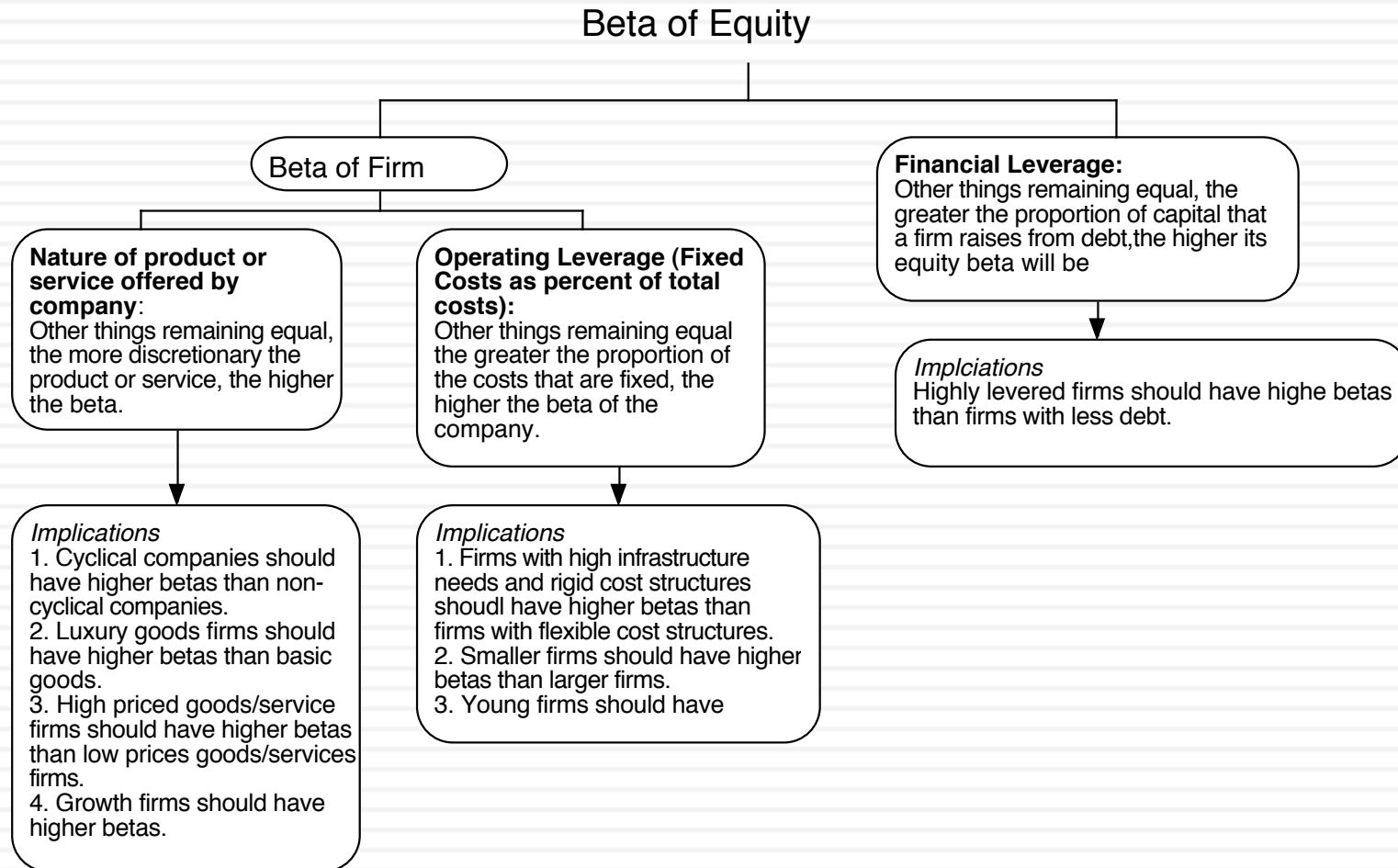

Bottom-up Betas

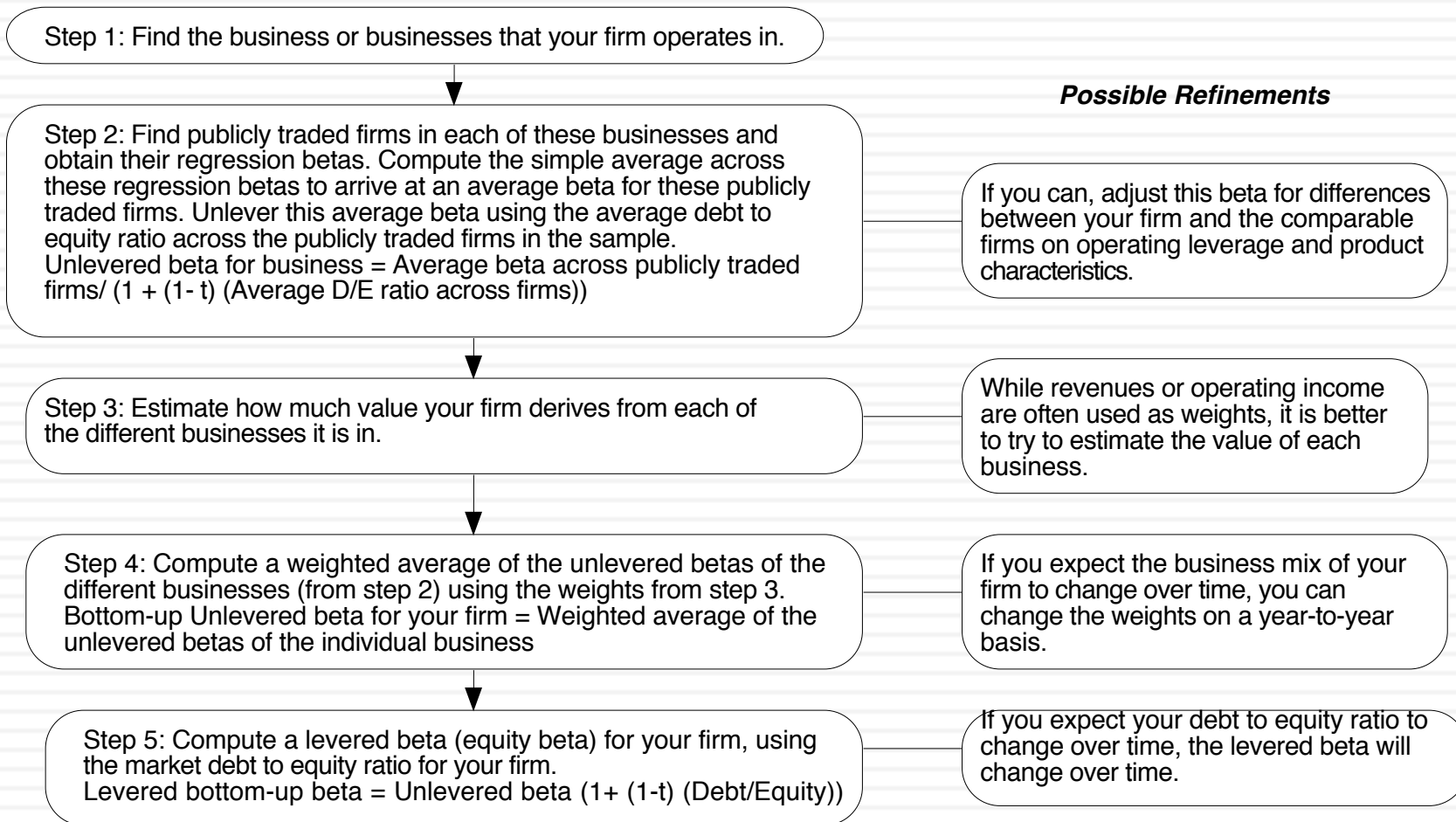

Three examples...

- Amgen

- The unlevered beta for pharmaceutical firms is 1.59. Using Amgen's debt to equity ratio of 11%, the bottom up beta for Amgen is
 - Bottom-up Beta = $1.59 (1 + (1 - .35)(.11)) = 1.73$

- Tata Motors

- The unlevered beta for automobile firms is 0.98. Using Tata Motor's debt to equity ratio of 33.87%, the bottom up beta for Tata Motors is
 - Bottom-up Beta = $0.98 (1 + (1 - .3399)(.3387)) = 1.20$

- Indofoods

| <i>Business</i> | <i>Revenues</i> | <i>EV/Sales</i> | <i>Estimated Value</i> | <i>Weight</i> | <i>Unlevered Beta</i> |
|---------------------|-----------------|-----------------|------------------------|---------------|-----------------------|
| Food Processing | IDR48,119 | 1.6400 | IDR 78,915 | 81.35% | 0.7200 |
| Food Wholesalers | IDR5,113 | 0.3800 | IDR 1,943 | 2.00% | 0.4900 |
| Farming/Agriculture | IDR12,325 | 1.3100 | IDR 16,145 | 16.64% | 0.7600 |
| Company | IDR65,557 | | IDR 97,003 | | 0.7221 |

Aswath Damodaran

Levered Beta = $0.7221 (1 + (1 - .25)(.4193)) = 0.95$

V. And the past is not always a good indicator of the future.

| | <i>Arithmetic Average</i> | | <i>Geometric Average</i> | |
|-----------|---------------------------|-------------------|--------------------------|-------------------|
| | Stocks - T. Bills | Stocks - T. Bonds | Stocks - T. Bills | Stocks - T. Bonds |
| 1928-2015 | 7.92% | 6.18% | 6.05% | 4.54% |
| Std Error | <i>2.15%</i> | <i>2.29%</i> | | |
| 1966-2015 | 6.05% | 3.89% | 4.69% | 2.90% |
| Std Error | <i>2.42%</i> | <i>2.74%</i> | | |
| 2006-2015 | 7.87% | 3.88% | 6.11% | 2.53% |
| Std Error | <i>6.06%</i> | <i>8.66%</i> | | |

- If you are going to use a historical risk premium, make it
 - ▣ Long term (because of the standard error)
 - ▣ Consistent with your risk free rate
 - ▣ A “compounded” average
- No matter which estimate you use, recognize that it is backward looking, is noisy and may reflect selection bias.

But in the future..

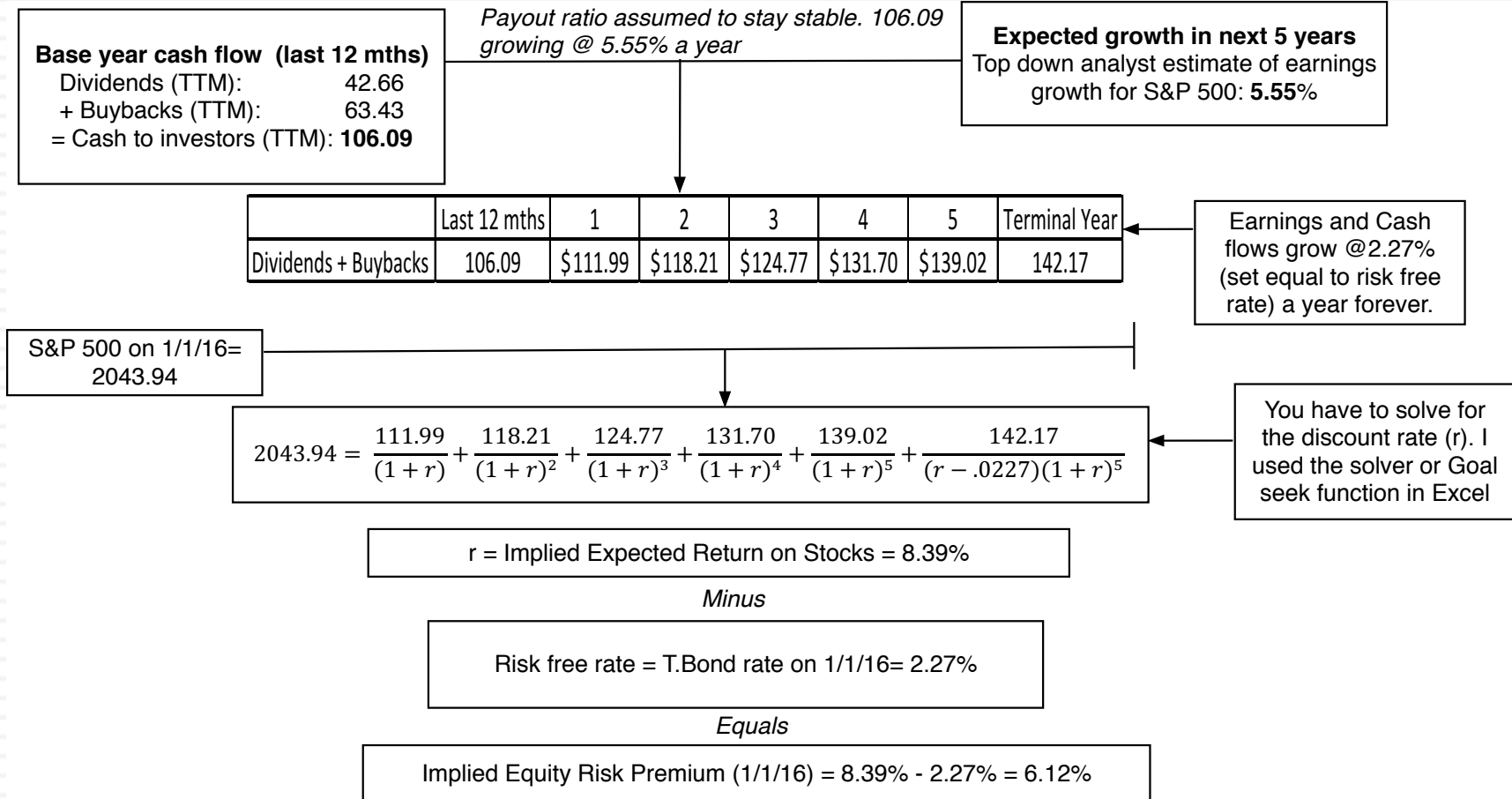

Implied Premiums in the US: 1960-2015

Implied Premium for US Equity Market: 1960-2015

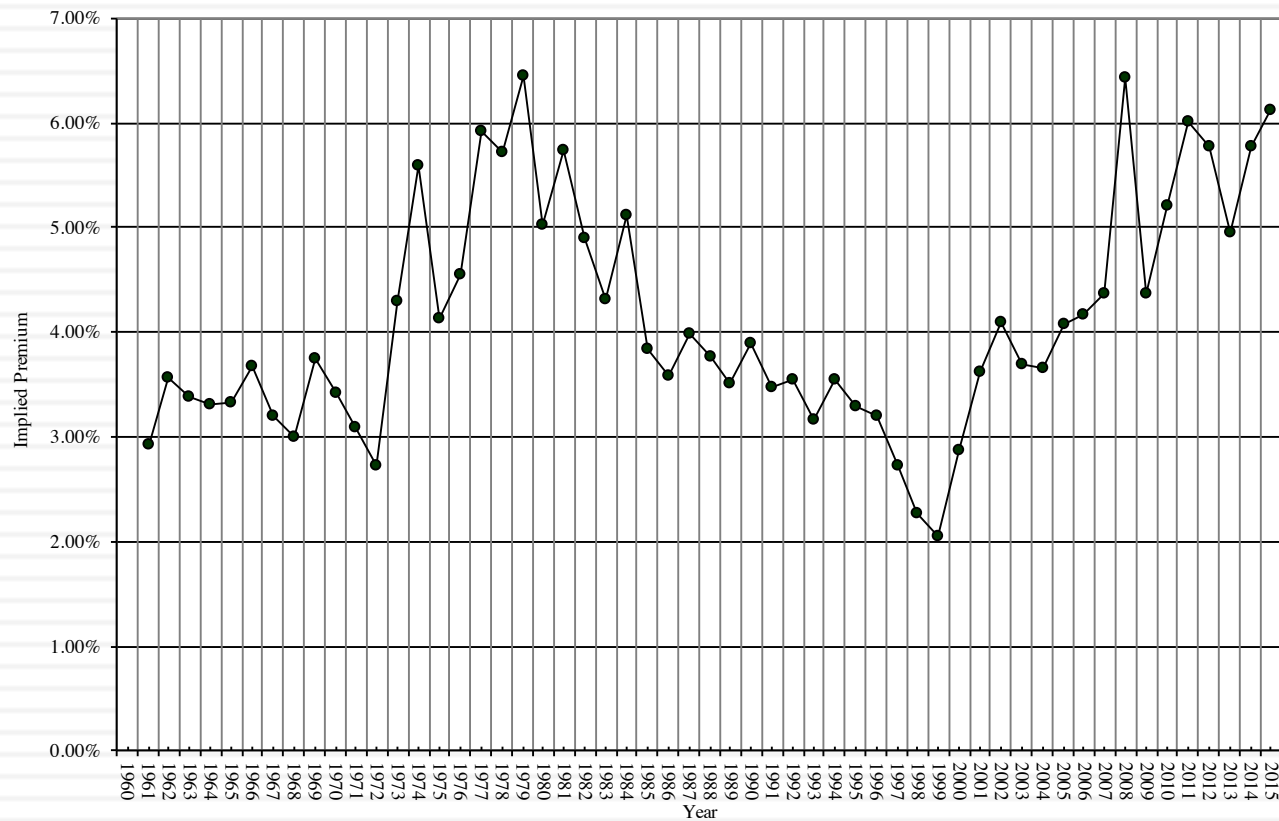

The Anatomy of a Crisis: Implied ERP from September 12, 2008 to January 1, 2009

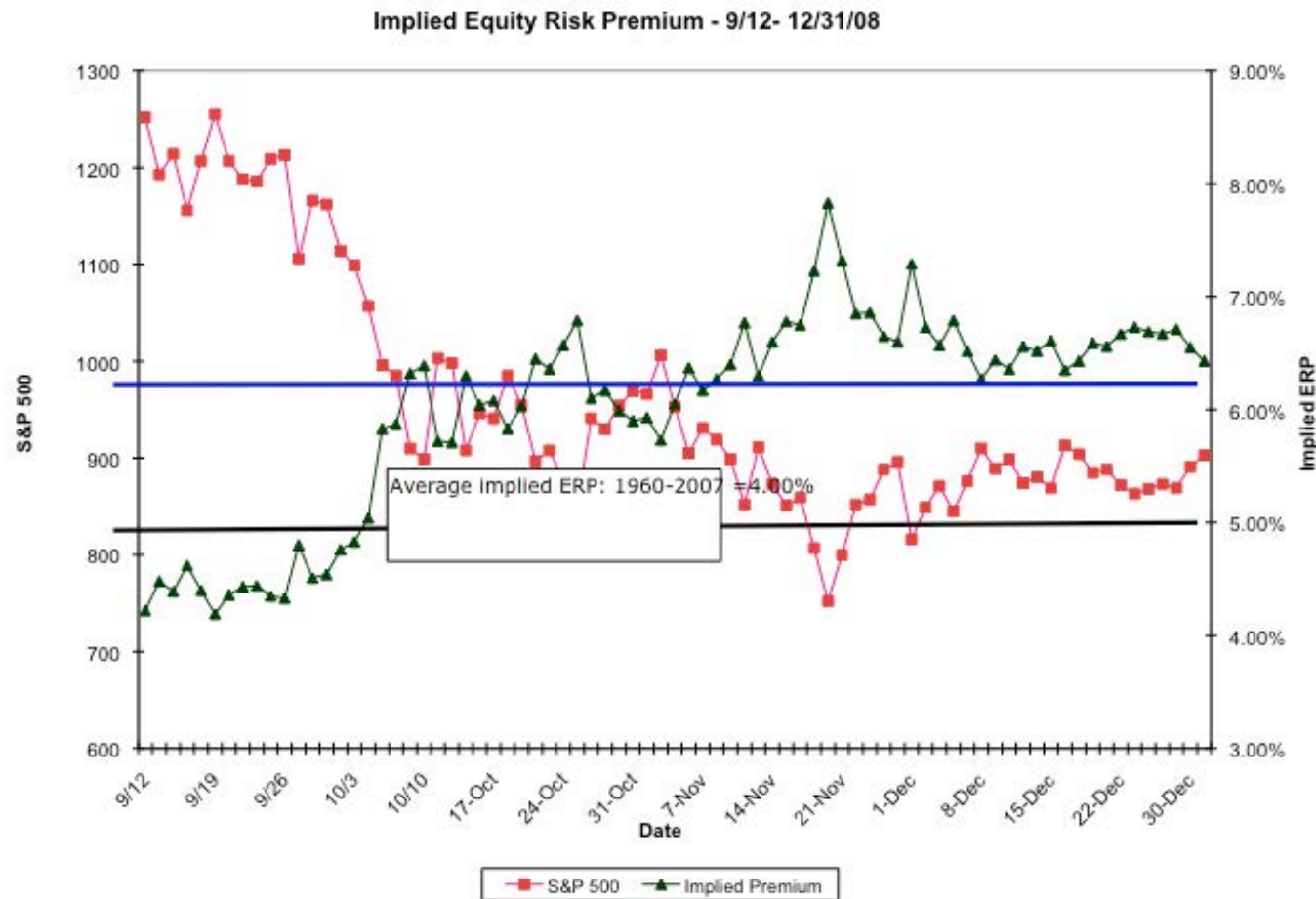

Implied Premium for India using the Sensex: April 2010

- Level of the Index = 17559
- FCFE on the Index = 3.5% (Estimated FCFE for companies in index as % of market value of equity)
- Other parameters
 - Riskfree Rate = 5% (Rupee)
 - Expected Growth (in Rupee)
 - Next 5 years = 20% (Used expected growth rate in Earnings)
 - After year 5 = 5%
- Solving for the expected return:
 - Expected return on Equity = 11.72%
 - Implied Equity premium for India = $11.72\% - 5\% = 6.72\%$

Emerging versus Developed Markets: Implied Equity Risk Premiums

$$PBV = \frac{(\text{Return on equity} - \text{Expected growth rate})}{(\text{Cost of equity} - \text{Expected growth rate})}$$

$$\text{Cost of Equity} = \frac{(\text{ROE} - \text{Expected growth rate})}{PBV} + \text{Expected growth rate}$$

| Start of year | PBV Developed | PBV Emerging | ROE Developed | ROE Emerging | US T.Bond rate | Growth Rate Developed | Growth Rate Emerging | Cost of Equity (Developed) | Cost of Equity (Emerging) | Differential ERP |
|---------------|---------------|--------------|---------------|--------------|----------------|-----------------------|----------------------|----------------------------|---------------------------|------------------|
| 2004 | 2.00 | 1.19 | 10.81% | 11.65% | 4.25% | 3.75% | 5.25% | 7.28% | 10.63% | 3.35% |
| 2005 | 2.09 | 1.27 | 11.12% | 11.93% | 4.22% | 3.72% | 5.22% | 7.26% | 10.50% | 3.24% |
| 2006 | 2.03 | 1.44 | 11.32% | 12.18% | 4.39% | 3.89% | 5.39% | 7.55% | 10.11% | 2.56% |
| 2007 | 1.67 | 1.67 | 10.87% | 12.88% | 4.70% | 4.20% | 5.70% | 8.19% | 10.00% | 1.81% |
| 2008 | 0.87 | 0.83 | 9.42% | 11.12% | 4.02% | 3.52% | 5.02% | 10.30% | 12.37% | 2.07% |
| 2009 | 1.20 | 1.34 | 8.48% | 11.02% | 2.21% | 1.71% | 3.21% | 7.35% | 9.04% | 1.69% |
| 2010 | 1.39 | 1.43 | 9.14% | 11.22% | 3.84% | 3.34% | 4.84% | 7.51% | 9.30% | 1.79% |
| 2011 | 1.12 | 1.08 | 9.21% | 10.04% | 3.29% | 2.79% | 4.29% | 8.52% | 9.61% | 1.09% |
| 2012 | 1.17 | 1.18 | 9.10% | 9.33% | 1.88% | 1.38% | 2.88% | 7.98% | 8.35% | 0.37% |
| 2013 | 1.56 | 1.63 | 8.67% | 10.48% | 1.76% | 1.26% | 2.76% | 6.02% | 7.50% | 1.48% |
| 2014 | 1.95 | 1.50 | 9.27% | 9.64% | 3.04% | 2.54% | 4.04% | 6.00% | 7.77% | 1.77% |
| 2015 | 1.88 | 1.56 | 9.69% | 9.75% | 2.17% | 1.67% | 3.17% | 5.94% | 7.39% | 1.45% |
| 2016 | 1.89 | 1.59 | 9.24% | 10.16% | 2.27% | 1.77% | 3.27% | 5.72% | 7.60% | 1.88% |

VI. There is a downside to globalization...

Damodaran Online: ERP Estimation Procedure

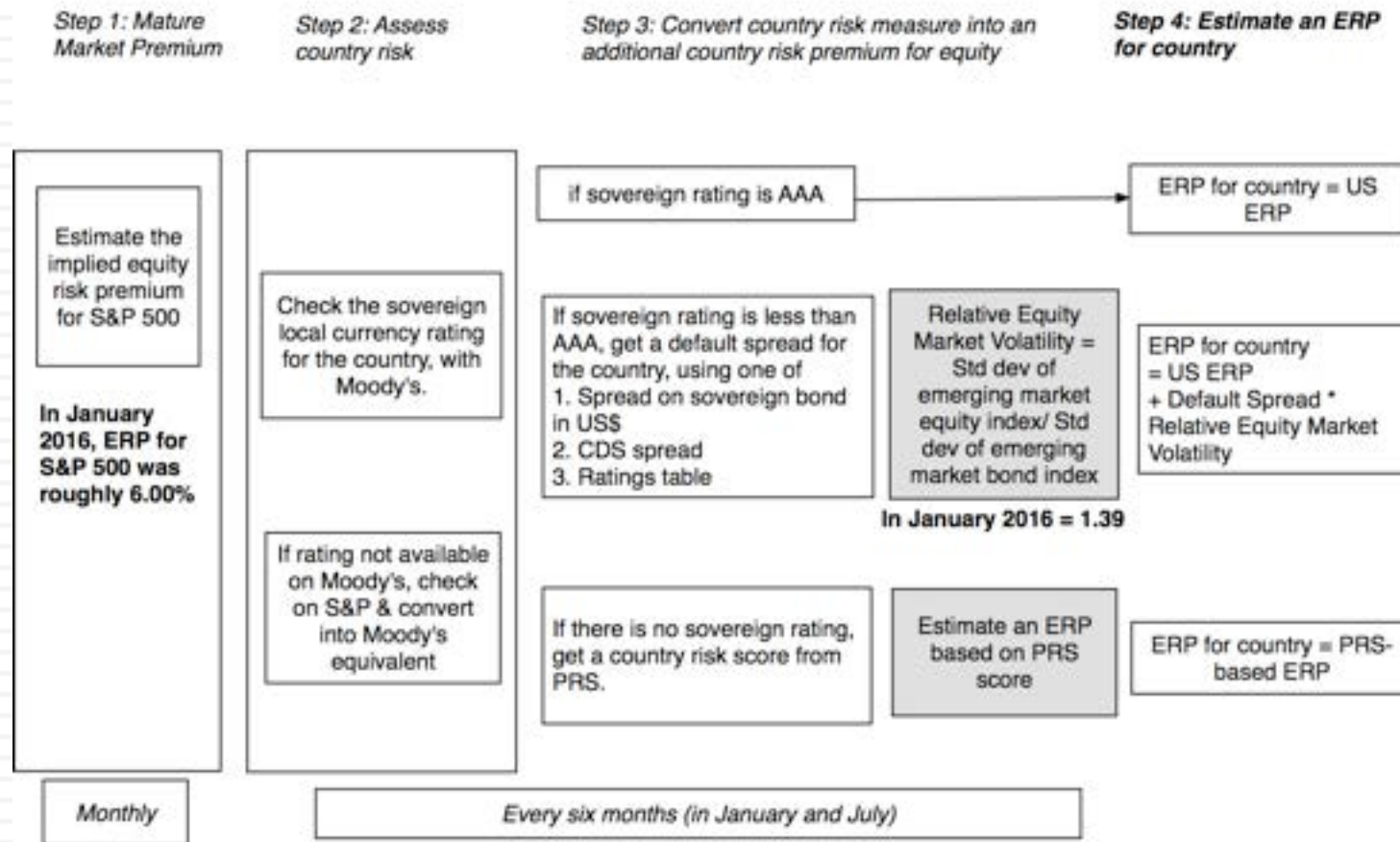

ERP : Jan 2016

| | | | | | |
|-------------|--------|--------|-----------------------|--------------|--------------|
| Andorra | 9.28% | 3.28% | Jersey (States of) | 6.59% | 0.59% |
| Austria | 6.00% | 0.00% | Liechtenstein | 6.00% | 0.00% |
| Belgium | 6.90% | 0.90% | Luxembourg | 6.00% | 0.00% |
| Cyprus | 12.71% | 6.71% | Malta | 7.79% | 1.79% |
| Denmark | 6.00% | 0.00% | Netherlands | 6.00% | 0.00% |
| Finland | 6.00% | 0.00% | Norway | 6.00% | 0.00% |
| France | 6.74% | 0.74% | Portugal | 9.72% | 3.72% |
| Germany | 6.00% | 0.00% | Spain | 8.84% | 2.84% |
| Greece | 20.90% | 14.90% | Sweden | 6.00% | 0.00% |
| Guernsey | 6.59% | 0.59% | Switzerland | 6.00% | 0.00% |
| Iceland | 8.84% | 2.84% | Turkey | 9.28% | 3.28% |
| Ireland | 8.38% | 2.38% | United Kingdom | 6.59% | 0.59% |
| Isle of Man | 6.59% | 0.59% | Western Europe | 7.16% | 1.16% |
| Italy | 8.84% | 2.84% | | | |

| | | |
|------------------------------------|--------------|--------------|
| Albania | 12.71% | 6.71% |
| Armenia | 11.37% | 5.37% |
| Azerbaijan | 9.28% | 3.28% |
| Belarus | 17.17% | 11.17% |
| Bosnia | 15.70% | 9.70% |
| Bulgaria | 8.84% | 2.84% |
| Croatia | 9.72% | 3.72% |
| Czech Republic | 7.05% | 1.05% |
| Estonia | 7.05% | 1.05% |
| Georgia | 11.37% | 5.37% |
| Hungary | 9.72% | 3.72% |
| Kazakhstan | 8.84% | 2.84% |
| Latvia | 7.79% | 1.79% |
| Lithuania | 7.79% | 1.79% |
| Macedonia | 11.37% | 5.37% |
| Moldova | 15.70% | 9.70% |
| Montenegro | 11.37% | 5.37% |
| Poland | 7.26% | 1.26% |
| Romania | 9.28% | 3.28% |
| Russia | 9.72% | 3.72% |
| Serbia | 12.71% | 6.71% |
| Slovakia | 7.26% | 1.26% |
| Slovenia | 9.28% | 3.28% |
| Ukraine | 20.90% | 14.90% |
| Eastern Europe & Russia | 9.65% | 3.65% |

| Frontier Markets (not rated) | | | | | | | |
|------------------------------|------|--------|--------|-----------------|------|--------|--------|
| Algeria | 63.0 | 12.71% | 6.71% | Malawi | 57.0 | 17.17% | 11.17% |
| Brunei | 72.8 | 8.84% | 2.84% | Mali | 62.5 | 12.71% | 6.71% |
| Gambia | 62.0 | 14.20% | 8.20% | Myanmar | 63.3 | 12.71% | 6.71% |
| Guinea | 53.8 | 17.17% | 11.17% | Niger | 51.0 | 17.17% | 11.17% |
| Guinea-Bissau | 62.3 | 12.71% | 6.71% | Sierra Leone | 56.5 | 17.17% | 11.17% |
| Guyana | 63.5 | 12.71% | 6.71% | Somalia | 42.5 | 20.90% | 14.90% |
| Haiti | 57.0 | 17.17% | 11.17% | Sudan | 48.3 | 20.90% | 14.90% |
| Iran | 67.8 | 10.48% | 4.48% | Syria | 35.8 | 25.00% | 19.00% |
| Iraq | 56.0 | 17.17% | 11.17% | Tanzania | 63.0 | 12.71% | 6.71% |
| Korea, D.P.R. | 56.0 | 17.17% | 11.17% | Togo | 63.8 | 12.71% | 6.71% |
| Liberia | 50.5 | 17.17% | 11.17% | Yemen, Republic | 50.3 | 17.17% | 11.17% |
| Libya | 52.8 | 17.17% | 11.17% | Zimbabwe | 54.5 | 17.17% | 11.17% |
| Madagascar | 61.3 | 14.20% | 8.20% | | | | |

| | | |
|----------------------|--------------|--------------|
| Canada | 6.00% | 0.00% |
| US | 6.00% | 0.00% |
| North America | 6.00% | 0.00% |

| | | |
|------------------|---------------|--------------|
| Caribbean | 14.61% | 8.61% |
|------------------|---------------|--------------|

| | | |
|----------------------|---------------|--------------|
| Argentina | 17.17% | 11.17% |
| Belize | 19.42% | 13.42% |
| Bolivia | 11.37% | 5.37% |
| Brazil | 9.28% | 3.28% |
| Chile | 6.90% | 0.90% |
| Colombia | 8.84% | 2.84% |
| Costa Rica | 9.72% | 3.72% |
| Ecuador | 15.70% | 9.70% |
| El Salvador | 11.37% | 5.37% |
| Guatemala | 9.72% | 3.72% |
| Honduras | 15.70% | 9.70% |
| Mexico | 7.79% | 1.79% |
| Nicaragua | 14.20% | 8.20% |
| Panama | 8.84% | 2.84% |
| Paraguay | 9.72% | 3.72% |
| Peru | 7.79% | 1.79% |
| Suriname | 11.37% | 5.37% |
| Uruguay | 8.84% | 2.84% |
| Venezuela | 20.90% | 14.90% |
| Latin America | 10.42% | 4.42% |

| Country | ERP | CRP |
|------------------|---------------|--------------|
| Angola | 10.48% | 4.48% |
| Botswana | 7.26% | 1.26% |
| Burkina Faso | 15.70% | 9.70% |
| Cameroon | 14.20% | 8.20% |
| Cape Verde | 14.20% | 8.20% |
| Congo (DR) | 15.70% | 9.70% |
| Congo (Republic) | 11.37% | 5.37% |
| Côte d'Ivoire | 11.37% | 5.37% |
| Egypt | 15.70% | 9.70% |
| Ethiopia | 12.71% | 6.71% |
| Gabon | 11.37% | 5.37% |
| Ghana | 15.70% | 9.70% |
| Kenya | 12.71% | 6.71% |
| Morocco | 9.72% | 3.72% |
| Mozambique | 14.20% | 8.20% |
| Namibia | 9.28% | 3.28% |
| Nigeria | 11.37% | 5.37% |
| Rwanda | 12.71% | 6.71% |
| Senegal | 12.71% | 6.71% |
| South Africa | 8.84% | 2.84% |
| Tunisia | 11.37% | 5.37% |
| Uganda | 12.71% | 6.71% |
| Zambia | 14.20% | 8.20% |
| Africa | 11.76% | 5.76% |

| | | |
|----------------------|--------------|--------------|
| Abu Dhabi | 6.74% | 0.74% |
| Bahrain | 9.28% | 3.28% |
| Israel | 7.05% | 1.05% |
| Jordan | 12.71% | 6.71% |
| Kuwait | 6.74% | 0.74% |
| Lebanon | 14.20% | 8.20% |
| Oman | 7.05% | 1.05% |
| Qatar | 6.74% | 0.74% |
| Ras Al Khaimah | 7.26% | 1.26% |
| Saudi Arabia | 6.90% | 0.90% |
| Sharjah | 7.79% | 1.79% |
| United Arab Emirates | 6.74% | 0.74% |
| Middle East | 7.11% | 1.11% |

| | | |
|------------------|--------------|--------------|
| Bangladesh | 11.37% | 5.37% |
| Cambodia | 14.20% | 8.20% |
| China | 6.90% | 0.90% |
| Fiji | 12.71% | 6.71% |
| Hong Kong | 6.59% | 0.59% |
| India | 9.28% | 3.28% |
| Indonesia | 9.28% | 3.28% |
| Japan | 7.05% | 1.05% |
| Korea | 6.74% | 0.74% |
| Macao | 6.74% | 0.74% |
| Malaysia | 7.79% | 1.79% |
| Mauritius | 8.38% | 2.38% |
| Mongolia | 14.20% | 8.20% |
| Pakistan | 15.70% | 9.70% |
| Papua New Guinea | 12.71% | 6.71% |
| Philippines | 8.84% | 2.84% |
| Singapore | 6.00% | 0.00% |
| Sri Lanka | 12.71% | 6.71% |
| Taiwan | 6.90% | 0.90% |
| Thailand | 8.38% | 2.38% |
| Vietnam | 12.71% | 6.71% |
| Asia | 7.49% | 1.49% |

| | | |
|---------------------------|--------------|--------------|
| Australia | 6.00% | 0.00% |
| Cook Islands | 12.71% | 6.71% |
| New Zealand | 6.00% | 0.00% |
| Australia & NZ | 6.00% | 0.00% |

Black #: Total ERP
 Red #: Country risk premium
 AVG: GDP weighted average

VII. And it is not just emerging market companies that are exposed to this risk..

- The “default” approach in valuation has been to assign country risk based upon your country of incorporation. Thus, if you are incorporated in a developed market, the assumption has been that you are not exposed to emerging market risks. If you are incorporated in an emerging market, you are saddled with the entire country risk.
- As companies globalize and look for revenues in foreign markets, this practice will under estimate the costs of equity of developed market companies with significant emerging market risk exposure and over estimate the costs of equity of emerging market companies with significant developed market risk exposure.

One way of dealing with this: Operation-based ERP for Indofoods

| Country | Revenues | ERP | Weight | Weighted ERP |
|-------------------|--------------|--------|----------------|--------------|
| Indonesia | 58685 | 9.28% | 91.17% | 8.46% |
| Saudi Arabia | 933 | 6.90% | 1.45% | 0.10% |
| Vietnam | 600 | 12.71% | 0.93% | 0.12% |
| Nigeria | 511 | 11.37% | 0.79% | 0.09% |
| Singapore | 433 | 6.00% | 0.67% | 0.04% |
| Korea | 325 | 6.74% | 0.50% | 0.03% |
| Thailand | 310 | 8.38% | 0.48% | 0.04% |
| Rest of the World | 2575 | 7.45% | 4.00% | 0.30% |
| Total | 64372 | | 100.00% | 9.18% |

An alternate way: Estimating a company's exposure to country risk (Lambda)

- **Just as beta measures exposure to macro economic risk, lambda measures exposure just to country risk. Like beta, it is scaled around one.**
- The easiest and most accessible data is on revenues. Most companies break their revenues down by region. One simplistic solution would be to do the following:

$$\text{Lambda} = \% \text{ of revenues domestically}_{\text{firm}} / \% \text{ of revenues domestically}_{\text{average firm}}$$

- In 2008-09, Tata Motors got about 91.37% of its revenues in India and TCS got 7.62%. The average Indian firm gets about 80% of its revenues in India:
 - ▣ $\text{Lambda}_{\text{Tata Motors}} = 91\%/80\% = 1.14$
 - ▣ The danger of focusing just on revenues is that it misses other exposures to risk (production and operations).

| | <i>Tata Motors</i> | <i>TCS</i> |
|-------------------------------------|---|--------------------------------|
| % of production/operations in India | High | High |
| % of revenues in India | 91.37% (in 2009) Estimated 70% (in 2010) | 7.62% |
| Lambda | 0.80 | 0.20 |
| Flexibility in moving operations | Low. Significant physical assets. | High. Human capital is mobile. |

VIII. Growth has to be earned (not endowed or estimated)

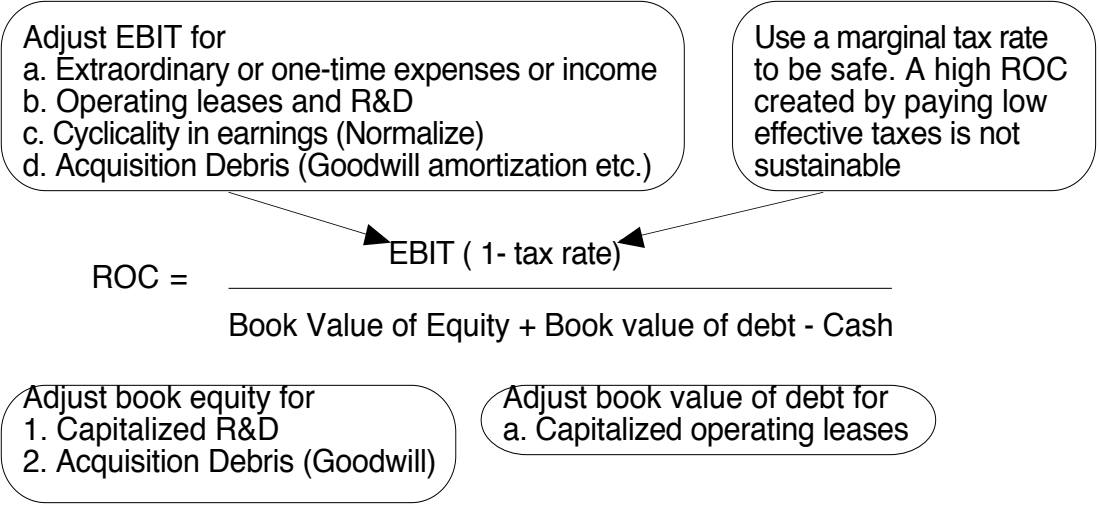
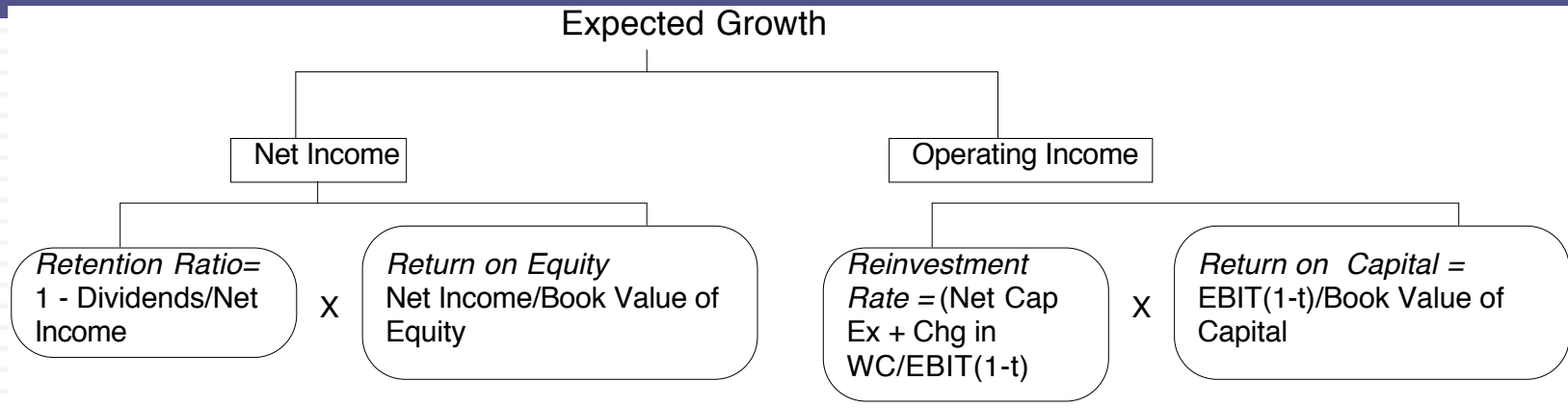

Use end of prior year numbers or average over the year but be consistent in your application

Sounds simple, right? But companies seem to have trouble in practice

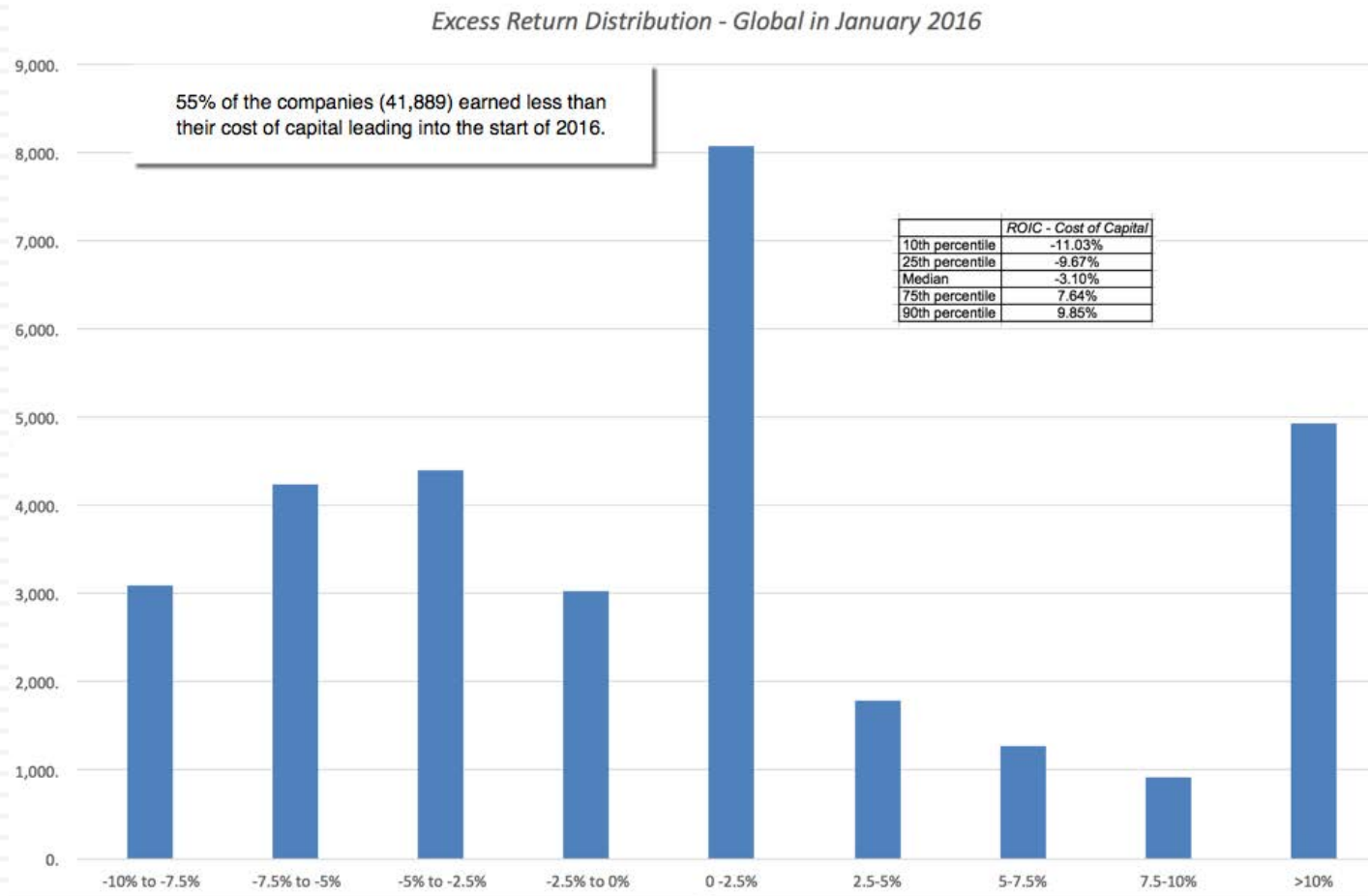

IX. All good things come to an end..And the terminal value is not an ATM...

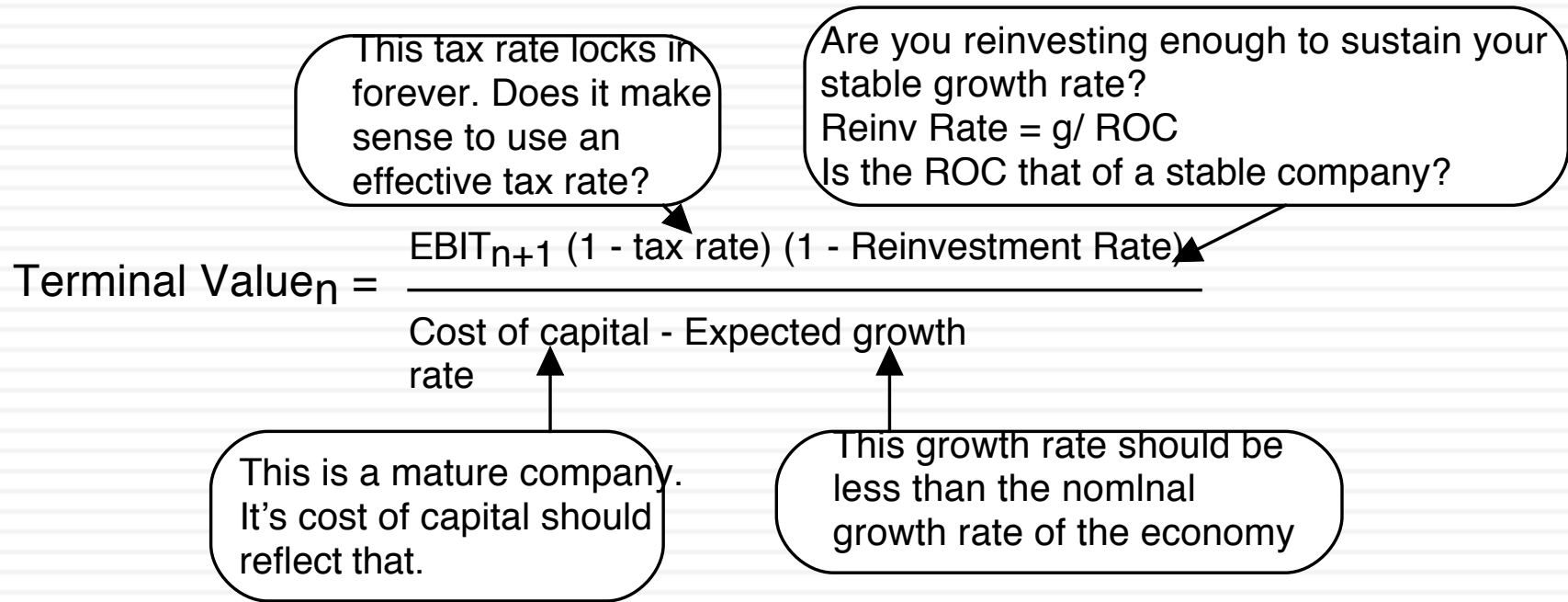

Terminal Value and Growth

| Stable Growth Rate | Amgen | Tata Motors | Indofood |
|--------------------|---------------|---------------|--------------|
| 0% | \$150,652 | ₹ 435,686 | IDR 168,226 |
| 1% | \$154,479 | ₹ 435,686 | IDR 168,226 |
| 2% | \$160,194 | ₹ 435,686 | IDR 168,226 |
| 3% | \$167,784 | ₹ 435,686 | IDR 168,226 |
| 4% | \$179,099 | ₹ 435,686 | IDR 168,226 |
| 5% | | ₹ 435,686 | IDR 168,226 |
| | | | |
| Risk free Rate | 4.78% | 5.00% | 5.04% |
| Cost of capital | 8.08% | 10.39% | 9.54% |
| Return on capital | 10.00% | 10.39% | 9.54% |

Aswath Damodaran



THE LOOSE ENDS IN VALUATION...

Aswath Damodaran

Getting from DCF to value per share: The Loose Ends

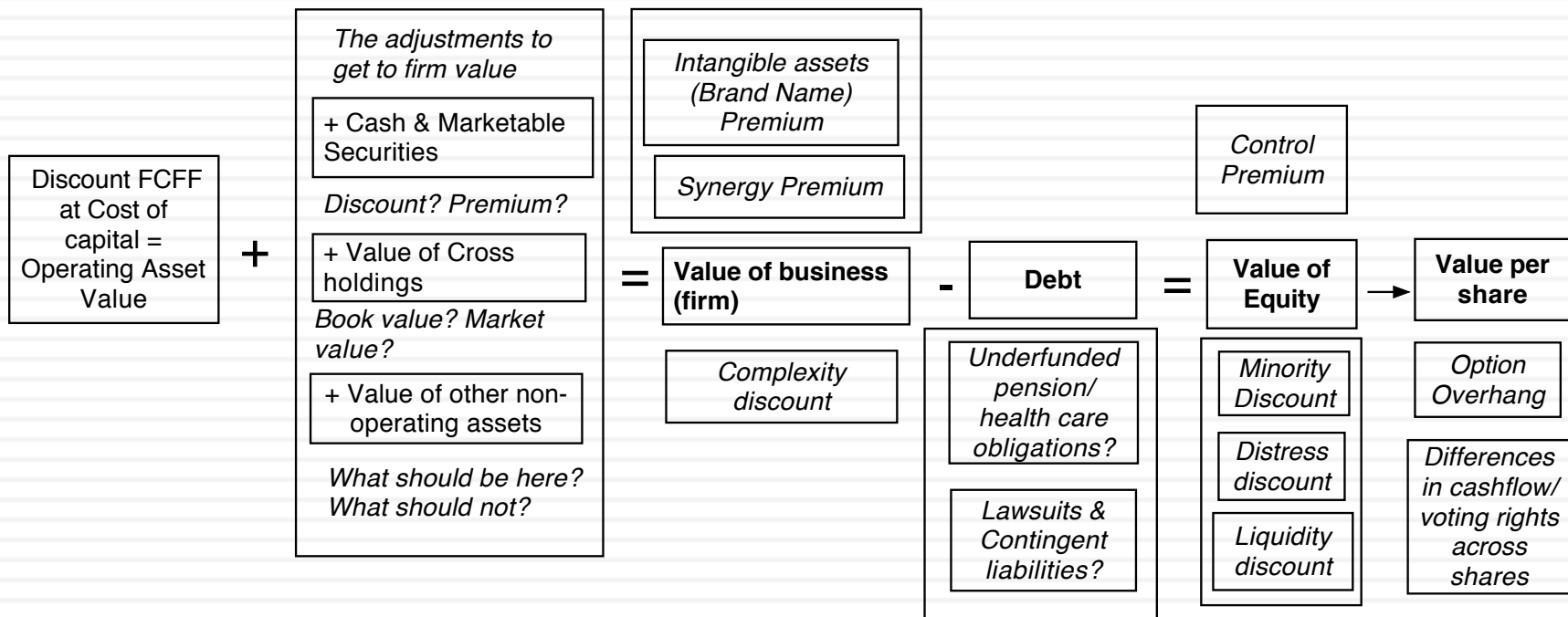

1. The Value of Cash

An Exercise in Cash Valuation

| | Company A | Company B | Company C |
|-------------------|--------------|--------------|--------------|
| Enterprise Value | \$ 1 billion | \$ 1 billion | \$ 1 billion |
| Cash | \$ 100 mil | \$ 100 mil | \$ 100 mil |
| Return on Capital | 10% | 5% | 22% |
| Cost of Capital | 10% | 10% | 12% |
| Trades in | US | US | Argentina |

- In which of these companies is cash most likely to trade at face value, at a discount and at a premium?

Cash: Discount or Premium?

*Market Value of \$ 1 in cash:
Estimates obtained by regressing Enterprise Value against Cash Balances*

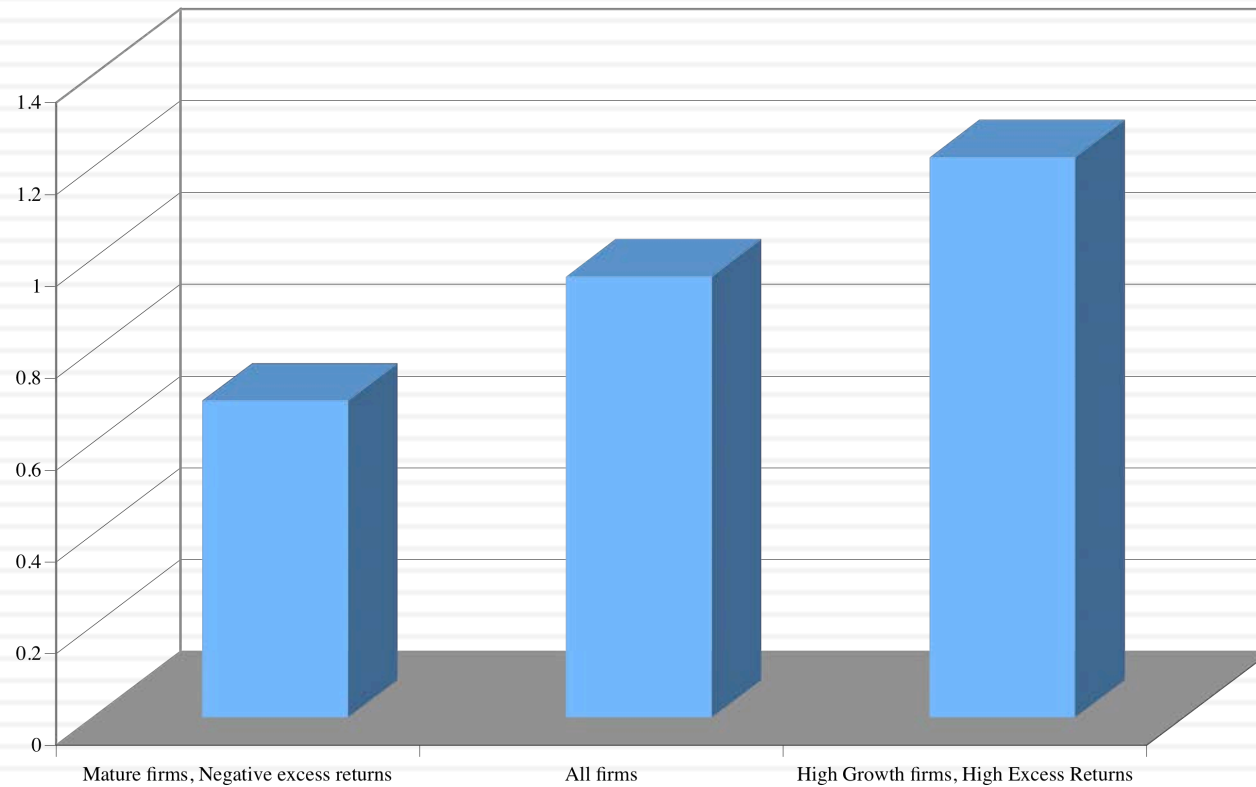

2. Dealing with Holdings in Other firms

- Holdings in other firms can be categorized into
 - ▣ Minority passive holdings, in which case only the dividend from the holdings is shown in the balance sheet
 - ▣ Minority active holdings, in which case the share of equity income is shown in the income statements
 - ▣ Majority active holdings, in which case the financial statements are consolidated.
- We tend to be sloppy in practice in dealing with cross holdings. After valuing the operating assets of a firm, using consolidated statements, it is common to add on the balance sheet value of minority holdings (which are in book value terms) and subtract out the minority interests (again in book value terms), representing the portion of the consolidated company that does not belong to the parent company.

How to value holdings in other firms.. In a perfect world..

- In a perfect world, we would strip the parent company from its subsidiaries and value each one separately. The value of the combined firm will be
 - ▣ Value of parent company + Proportion of value of each subsidiary
- To do this right, you will need to be provided detailed information on each subsidiary to estimate cash flows and discount rates.

Indofood's Cross Holdings

10. PENYERTAAN JANGKA PANJANG

Penyertaan jangka panjang terdiri dari:

| | Nilai Perolehan/ Cost | Akumulasi Bagian Laba (Rugi) Neto dan Laba (Rugi) Komprehensif Lain Entitas Asosiasi/ Accumulated Equity Share in Net Income (Losses) and Other Comprehensive Income (Losses) of Associated | Tambahan Setoran Modal/ Additional Capital | Eliminasi Laba Penjualan Downstream/ Elimination of Downstream Sales Profit | Nilai Tercatat/ Carrying Amount |
|-------------------------|--------------------------|---|--|---|---------------------------------------|
| 31 Desember 2015 | | | | | |
| Metode ekuitas | | | | | |
| Entitas Asosiasi | | | | | |
| NICI | 100.000 | (7.321) | - | - | 92.679 |
| AIBM | 592.900 | (115.153) | - | (13.313) | 464.434 |
| Heliae | 250.668 | (222.558) | 104.836 | - | 132.946 |
| FPNRL | 354.335 | 3.147 | 196.804 | - | 554.286 |
| PCIB | 19 | - | - | - | 19 |
| PSM | 6.000 | 636 | - | - | 6.636 |
| OIMP | - | (3.713) | 41.650 | - | 37.937 |
| Ventura Bersama | | | | | |
| CMAA | 798.678 | (381.168) | 189.541 | - | 607.051 |
| Sub-total | 2.102.600 | (726.130) | 532.831 | (13.313) | 1.895.988 |
| Metode biaya perolehan | 2.245 | - | - | - | 2.245 |
| Total | 2.104.845 | (726.130) | 532.831 | (13.313) | 1.898.233 |

10. LONG-TERM INVESTMENTS

Long-term investments consist of:

| |
|--------------------------|
| December 31, 2015 |
| At equity method |
| Associates |
| NICI |
| AIBM |
| Heliae |
| FPNRL |
| PCIB |
| PSM |
| OIMP |
| Joint Venture |
| CMAA |
| Sub-total |
| At cost method |
| Total |

Two compromise solutions...

- The market value solution: When the subsidiaries are publicly traded, you could use their traded market capitalizations to estimate the values of the cross holdings. You do risk carrying into your valuation any mistakes that the market may be making in valuation.
- The relative value solution: When there are too many cross holdings to value separately or when there is insufficient information provided on cross holdings, you can convert the book values of holdings that you have on the balance sheet (for both minority holdings and minority interests in majority holdings) by using the average price to book value ratio of the sector in which the subsidiaries operate.

Tata Motor's Cross Holdings

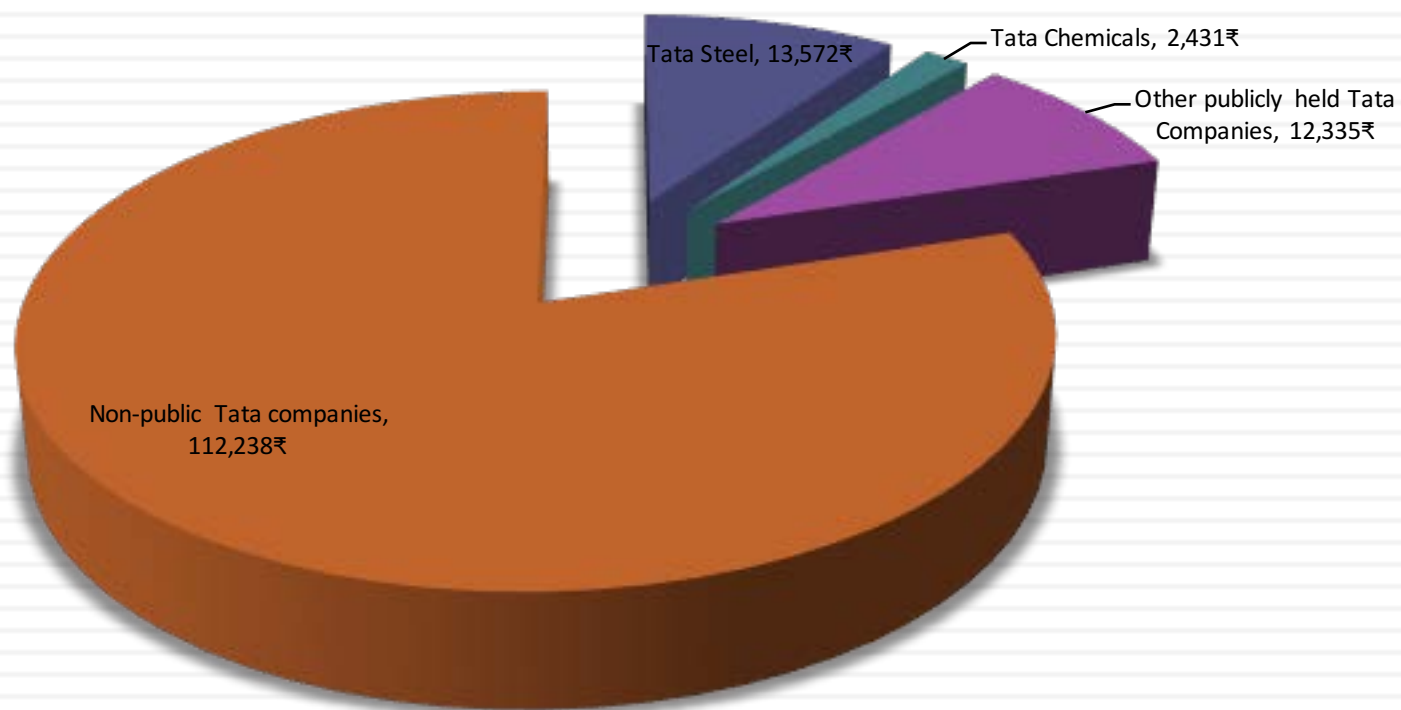

3. Other Assets that have not been counted yet..

- Unutilized assets: If you have assets or property that are not being utilized (vacant land, for example), you have not valued it yet. You can assess a market value for these assets and add them on to the value of the firm.
- Overfunded pension plans: If you have a defined benefit plan and your assets exceed your expected liabilities, you could consider the over funding with two caveats:
 - Collective bargaining agreements may prevent you from laying claim to these excess assets.
 - There are tax consequences. Often, withdrawals from pension plans get taxed at much higher rates.
- **Do not double count an asset.** If you count the income from an asset in your cash flows, you cannot count the market value of the asset in your value.

Indofood's Plantations

11. TANAMAN PERKEBUNAN

Tanaman Telah Menghasilkan

Tanaman telah menghasilkan terdiri dari:

| | 31 Desember 2015/ December 31, 2015 | 31 Desember 2014/ December 31, 2014 |
|---|--|--|
| Biaya Perolehan | | |
| Saldo awal | 7.579.695 | 6.921.786 |
| Reklasifikasi dari tanaman belum menghasilkan | 393.793 | 648.151 |
| Pengurangan | (303) | (11.539) |
| Lain-lain | (3.759) | 21.297 |
| Saldo akhir | 7.969.426 | 7.579.695 |
| Akumulasi Amortisasi | | |
| Saldo awal | 2.463.589 | 2.178.941 |
| Amortisasi | 312.582 | 291.990 |
| Pengurangan | (168) | (7.342) |
| Saldo akhir | 2.776.003 | 2.463.589 |
| Nilai tercatat neto | 5.193.423 | 5.116.106 |

11. PLANTATIONS

Mature Plantations

Mature plantations consist of:

| | Cost |
|---|------|
| Beginning balance | |
| Reclassifications from immature plantations | |
| Deductions | |
| Others | |
| Ending balance | |
| Accumulated Amortization | |
| Beginning balance | |
| Amortization | |
| Deduction | |
| Ending balance | |
| Net carrying amount | |

*Would you add this value on to your DCF value?
Why or why not?*

4. A Discount for Complexity: An Experiment

| | Company A | Company B |
|------------------|--------------|---------------------|
| Operating Income | \$ 1 billion | \$ 1 billion |
| Tax rate | 40% | 40% |
| ROIC | 10% | 10% |
| Expected Growth | 5% | 5% |
| Cost of capital | 8% | 8% |
| Business Mix | Single | Multiple Businesses |
| Holdings | Simple | Complex |
| Accounting | Transparent | Opaque |

□ Which firm would you value more highly?

Measuring Complexity: Volume of Data in Financial Statements

| <i>Company</i> | <i>Number of pages in last 10Q</i> | <i>Number of pages in last 10K</i> |
|-------------------|------------------------------------|------------------------------------|
| General Electric | 65 | 410 |
| Microsoft | 63 | 218 |
| Wal-mart | 38 | 244 |
| Exxon Mobil | 86 | 332 |
| Pfizer | 171 | 460 |
| Citigroup | 252 | 1026 |
| Intel | 69 | 215 |
| AIG | 164 | 720 |
| Johnson & Johnson | 63 | 218 |
| IBM | 85 | 353 |

Measuring Complexity: A Complexity Score

| Item | Factors | Follow-up Question | Answer | Weighting factor | Gerdau Score | GE Score |
|----------------------|--|---|--------|------------------|--------------|----------|
| Operating Income | 1. Multiple Businesses | Number of businesses (with more than 10% of revenues) = | 1 | 2.00 | 2 | 30 |
| | 2. One-time income and expenses | Percent of operating income = | 10% | 10.00 | 1 | 0.8 |
| | 3. Income from unspecified sources | Percent of operating income = | 0% | 10.00 | 0 | 1.2 |
| | 4. Items in income statement that are volatile | Percent of operating income = | 15% | 5.00 | 0.75 | 1 |
| Tax Rate | 1. Income from multiple locales | Percent of revenues from non-domestic locales = | 70% | 3.00 | 2.1 | 1.8 |
| | 2. Different tax and reporting books | Yes or No | No | Yes=3 | 0 | 3 |
| | 3. Headquarters in tax havens | Yes or No | No | Yes=3 | 0 | 0 |
| | 4. Volatile effective tax rate | Yes or No | Yes | Yes=2 | 2 | 0 |
| Capital Expenditures | 1. Volatile capital expenditures | Yes or No | Yes | Yes=2 | 2 | 2 |
| | 2. Frequent and large acquisitions | Yes or No | Yes | Yes=4 | 4 | 4 |
| | 3. Stock payment for acquisitions and investments | Yes or No | No | Yes=4 | 0 | 4 |
| Working capital | 1. Unspecified current assets and current liabilities | Yes or No | No | Yes=3 | 0 | 0 |
| | 2. Volatile working capital items | Yes or No | Yes | Yes=2 | 2 | 2 |
| Expected Growth rate | 1. Off-balance sheet assets and liabilities (operating leases and R&D) | Yes or No | No | Yes=3 | 0 | 3 |
| | 2. Substantial stock buybacks | Yes or No | No | Yes=3 | 0 | 3 |
| | 3. Changing return on capital over time | Is your return on capital volatile? | Yes | Yes=5 | 5 | 5 |
| | 4. Unsustainably high return | Is your firm's ROC much higher than industry average? | No | Yes=5 | 0 | 0 |
| Cost of capital | 1. Multiple businesses | Number of businesses (more than 10% of revenues) = | 1 | 1.00 | 1 | 20 |
| | 2. Operations in emerging markets | Percent of revenues = | 50% | 5.00 | 2.5 | 2.5 |
| | 3. Is the debt market traded? | Yes or No | No | No=2 | 2 | 0 |
| | 4. Does the company have a rating? | Yes or No | Yes | No=2 | 0 | 0 |
| | 5. Does the company have off-balance sheet debt? | Yes or No | No | Yes=5 | 0 | 5 |
| No-operating assets | Minority holdings as percent of book assets | Minority holdings as percent of book assets | 0% | 20.00 | 0 | 0.8 |
| Firm to Equity value | Consolidation of subsidiaries | Minority interest as percent of book value of equity | 63% | 20.00 | 12.6 | 1.2 |
| Per share value | Shares with different voting rights | Does the firm have shares with different voting rights? | Yes | Yes = 10 | 10 | 0 |
| | Equity options outstanding | Options outstanding as percent of shares | 0% | 10.00 | 0 | 0.2 |
| Complexity Score = | | | | | 48.95 | 90.55 |

Dealing with Complexity

□ In Discounted Cashflow Valuation

- The Aggressive Analyst: Trust the firm to tell the truth and value the firm based upon the firm's statements about their value.
- The Conservative Analyst: Don't value what you cannot see.
- The Compromise: Adjust the value for complexity
 - Adjust cash flows for complexity
 - Adjust the discount rate for complexity
 - Adjust the expected growth rate/ length of growth period
 - Value the firm and then discount value for complexity

□ In relative valuation

- In a relative valuation, you may be able to assess the price that the market is charging for complexity:
- With the hundred largest market cap firms, for instance:

$$PBV = 0.65 + 15.31 \text{ ROE} - 0.55 \text{ Beta} + 3.04 \text{ Expected growth rate} - 0.003 \#$$

Pages in 10K

5. The Value of Synergy

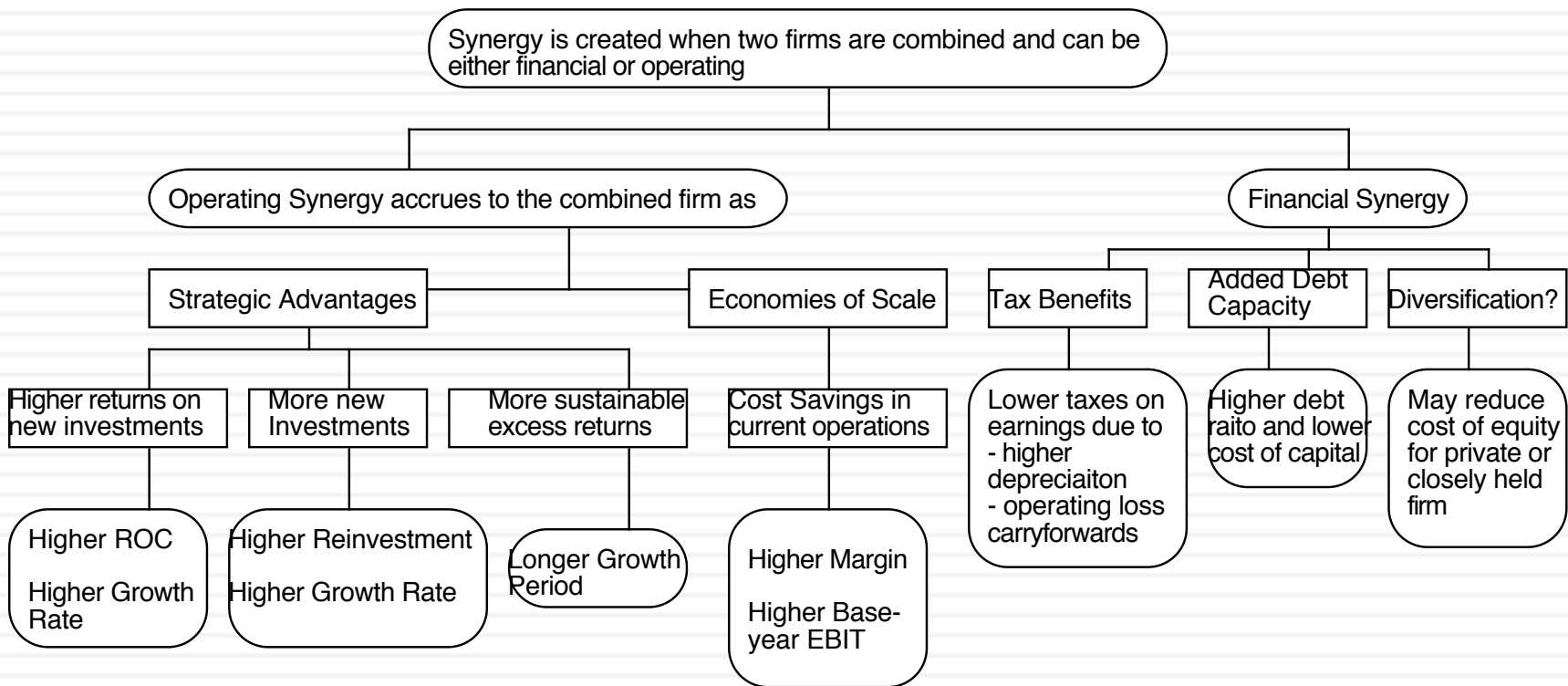

Valuing Synergy

- (1) the firms involved in the merger are valued independently, by discounting expected cash flows to each firm at the weighted average cost of capital for that firm.
- (2) the value of the combined firm, with no synergy, is obtained by adding the values obtained for each firm in the first step.
- (3) The effects of synergy are built into expected growth rates and cashflows, and the combined firm is re-valued with synergy.

$$\text{Value of Synergy} = \text{Value of the combined firm, with synergy} - \text{Value of the combined firm, without synergy}$$

Valuing Synergy: P&G + Gillette

Assume that \$250 million in operating expenses will be cut immediately. Translates into an after-tax increase in operating income of approximately \$158 million.

| | P&G | Gillette | Piglet: No Synergy | Piglet: Synergy |
|-------------------------------|------------|------------|--------------------|-----------------|
| Free Cashflow to Equity | \$5,864.74 | \$1,547.50 | \$7,412.24 | \$7,569.73 |
| Growth rate for first 5 years | 12% | 10% | 11.58% | 12.50% |
| Growth rate after five years | 4% | 4% | 4.00% | 4.00% |
| Beta | 0.90 | 0.80 | 0.88 | 0.88 |
| Cost of Equity | 7.90% | 7.50% | 7.81% | 7.81% |
| Value of Equity | \$221,292 | \$59,878 | \$281,170 | \$298,355 |

Assume that the combined company will grow at a faster rate (for the next decade) starting immediately.

6. Brand name, great management, superb product ...Are we short changing intangibles?

- There is often a temptation to add on premiums for intangibles. Here are a few examples.
 - ▣ Brand name
 - ▣ Great management
 - ▣ Loyal workforce
 - ▣ Technological prowess
- There are two potential dangers:
 - ▣ For some assets, the value may already be in your value and adding a premium will be double counting.
 - ▣ For other assets, the value may be ignored but incorporating it will not be easy.

Valuing Brand Name

| | Coca Cola | With Cott Margins |
|---------------------------------|------------------|--------------------------|
| Current Revenues = | \$21,962.00 | \$21,962.00 |
| Length of high-growth period | 10 | 10 |
| Reinvestment Rate = | 50% | 50% |
| Operating Margin (after-tax) | 15.57% | 5.28% |
| Sales/Capital (Turnover ratio) | 1.34 | 1.34 |
| Return on capital (after-tax) | 20.84% | 7.06% |
| Growth rate during period (g) = | 10.42% | 3.53% |
| Cost of Capital during period = | 7.65% | 7.65% |
| Stable Growth Period | | |
| Growth rate in steady state = | 4.00% | 4.00% |
| Return on capital = | 7.65% | 7.65% |
| Reinvestment Rate = | 52.28% | 52.28% |
| Cost of Capital = | 7.65% | 7.65% |
| Value of Firm = | \$79,611.25 | \$15,371.24 |

Valuing a Franchise: Star Wars

| | Add-on \$ per Box Office \$ |
|--------------------|-----------------------------|
| Streaming/Video | \$1.20 |
| Toys & Merchandise | \$2.00 |
| Books/eBooks | \$0.20 |
| Gaming | \$0.50 |
| Other | \$0.50 |

Star Wars Franchise Valuation: December 2015

Main Movies
World Box office of \$1.5 billion,
adjusted for 2% inflation.

Spin Off Movies
World Box office is 50% of
main movies.

| Add on \$ per box office \$ | Main Star Wars Movies | | | Star Wars Spin offs | | | |
|---|---|----------------|--------------|---------------------|------------|------------|--------|
| | Star Wars VII | Star Wars VIII | Star Wars IX | Rogue One | Hans Solo? | Boba Fett? | |
| Years from now | 0.0 | 2.0 | 4.0 | 1.0 | 3.0 | 5.0 | |
| Movies - Revenues | \$2,000 | \$2,081 | \$2,165 | \$1,020 | \$1,061 | \$1,104 | |
| Streaming/Video - Revenues | \$2,400 | \$2,497 | \$2,598 | \$1,224 | \$1,273 | \$1,325 | |
| Toys & Merchandise - Revenues | \$4,000 | \$4,162 | \$4,330 | \$2,040 | \$2,122 | \$2,208 | |
| Books/eBooks - Revenues | \$400 | \$416 | \$433 | \$204 | \$212 | \$221 | |
| Gaming - Revenues | \$1,000 | \$1,040 | \$1,082 | \$510 | \$531 | \$552 | |
| Other - Revenues | \$1,000 | \$1,040 | \$1,082 | \$510 | \$531 | \$552 | |
| Total - Revenues | \$10,800 | \$11,236 | \$11,690 | \$5,508 | \$5,731 | \$5,962 | |
| Operating Margin 20.14% for movies 15% for non-movies 30% tax rate | After-tax Operating Income (movies) | \$ 282 | \$ 293 | \$ 305 | \$ 144 | \$ 150 | \$ 156 |
| | After-tax Operating Income (non-movies) | \$ 924 | \$ 961 | \$ 1,000 | \$ 471 | \$ 490 | \$ 510 |
| | Present Value | \$ 1,206 | \$ 1,083 | \$ 973 | \$ 572 | \$ 514 | \$ 461 |
| | Value of new Star Wars movies = | \$4,809 | | | | | |
| | Value of continuing income = | \$5,163 | | | | | |
| | Value of Star Wars = | \$9,972 | | | | | |

Discounted back
@ 7.61% cost of
capital of
entertainment
companies

Assumes that revenues from add ons
continue after 2020, growing at 2% a year,
with 15% operating margin

7. Be circumspect about defining debt for cost of capital purposes...

- General Rule: Debt generally has the following characteristics:
 - ▣ Commitment to make fixed payments in the future
 - ▣ The fixed payments are tax deductible
 - ▣ Failure to make the payments can lead to either default or loss of control of the firm to the party to whom payments are due.
- Defined as such, debt should include
 - ▣ All interest bearing liabilities, short term as well as long term
 - ▣ All leases, operating as well as capital
- Debt should not include
 - ▣ Accounts payable or supplier credit

But should consider other potential liabilities when getting to equity value...

- If you have under funded pension fund or health care plans, you should consider the under funding at this stage in getting to the value of equity.
 - ▣ If you do so, you should not double count by also including a cash flow line item reflecting cash you would need to set aside to meet the unfunded obligation.
 - ▣ You should not be counting these items as debt in your cost of capital calculations....
- If you have contingent liabilities - for example, a potential liability from a lawsuit that has not been decided - you should consider the expected value of these contingent liabilities
 - ▣ Value of contingent liability = Probability that the liability will occur * Expected value of liability

8. The Value of Control

- The value of the control premium that will be paid to acquire a block of equity will depend upon two factors -
 - Probability that control of firm will change: This refers to the probability that incumbent management will be replaced. this can be either through acquisition or through existing stockholders exercising their muscle.
 - Value of Gaining Control of the Company: The value of gaining control of a company arises from two sources - the increase in value that can be wrought by changes in the way the company is managed and run, and the side benefits and perquisites of being in control
 - Value of Gaining Control = Present Value (Value of Company with change in control - Value of company without change in control) + Side Benefits of Control

Increase Cash Flows

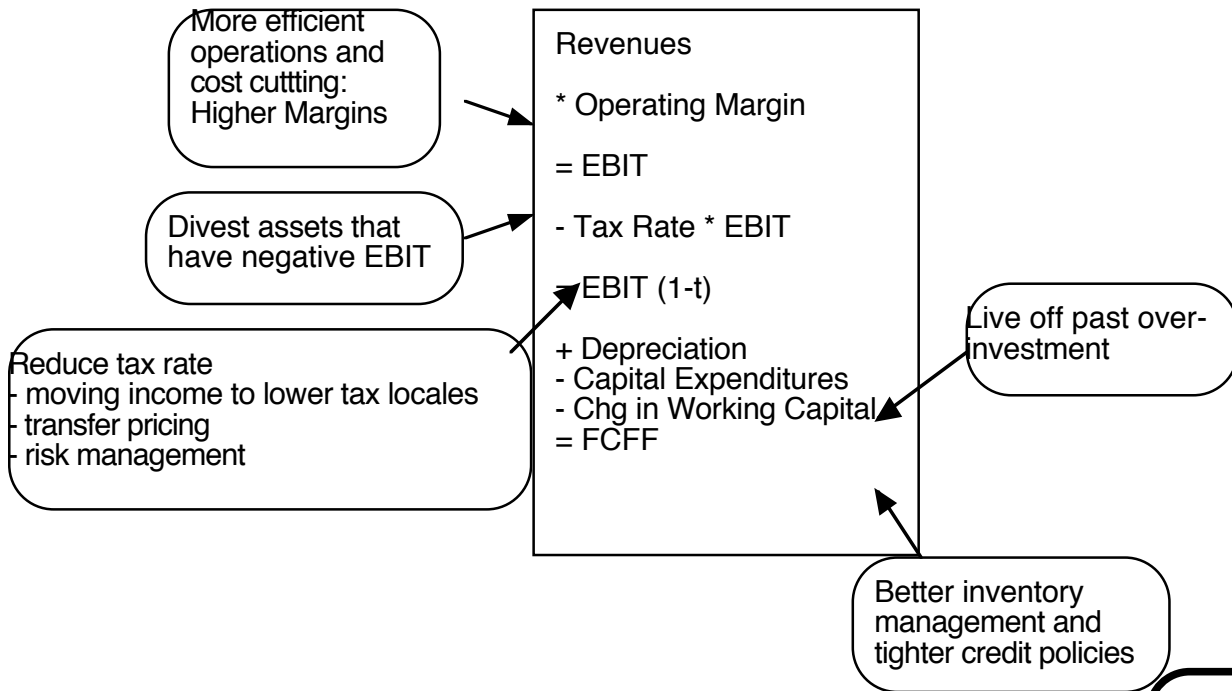

Reduce the cost of capital

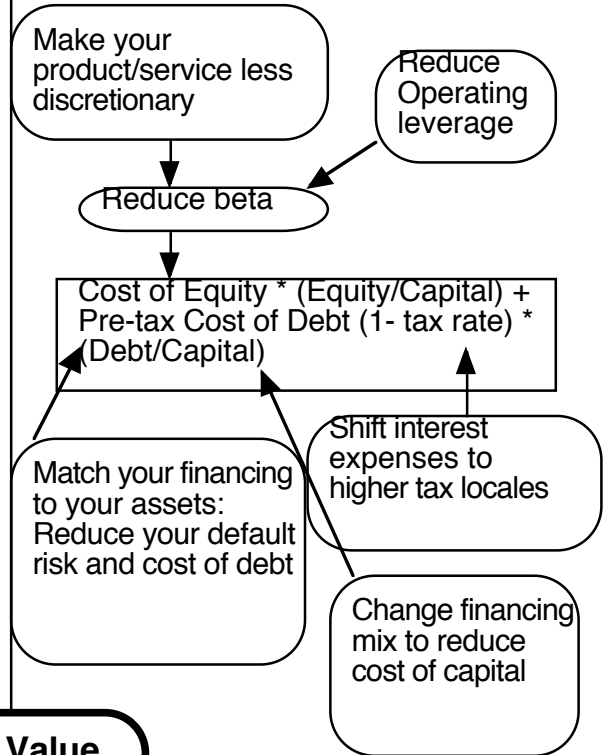

Firm Value

Increase Expected Growth

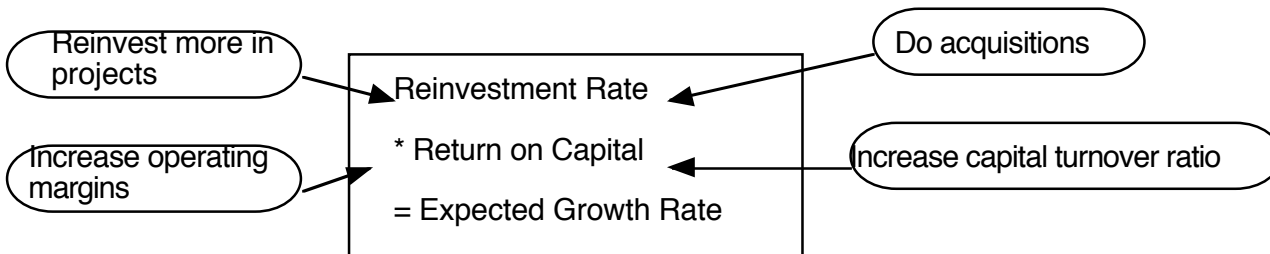

Increase length of growth period

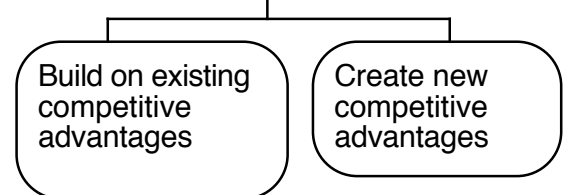

Adris Grupa (Status Quo): 4/2010

Current Cashflow to Firm
 EBIT(1-t) : 436 HRK
 - Nt CpX 3 HRK
 - Chg WC -118 HRK
 = FCFF 551 HRK
 Reinv Rate = (3-118)/436 = -26.35%;
 Tax rate = 17.35%
 Return on capital = 8.72%

Average from 2004-09
70.83%

Reinvestment Rate
70.83%

Expected Growth from new inv.
 $.7083 \times .0969 = 0.0686$
 or 6.86%

Average from 2004-09
9.69%

Return on Capital
9.69%

Stable Growth
 g = 4%; Beta = 0.80
 Country Premium = 2%
 Cost of capital = 9.92%
 Tax rate = 20.00%
 ROC = 9.92%;
 Reinvestment Rate = $g/ROC = 4/9.92 = 40.32\%$

Terminal Value₅ = $365 / (.0992 - .04) = 6170$ HRK

Op. Assets 4312
 + Cash: 1787
 - Debt 141
 - Minority int 465
 = Equity 5,484
 / (Common + Preferred shares)
 Value non-voting share 335 HRK/share

| Year | 1 | 2 | 3 | 4 | 5 | |
|----------------|---------|---------|---------|---------|---------|-------------------|
| EBIT (1-t) | HRK 466 | HRK 498 | HRK 532 | HRK 569 | HRK 608 | |
| - Reinvestment | HRK 330 | HRK 353 | HRK 377 | HRK 403 | HRK 431 | |
| FCFF | HRK 136 | HRK 145 | HRK 155 | HRK 166 | HRK 177 | |
| | | | | | | 612 246 365 |

Discount at \$ Cost of Capital (WACC) = 10.7% (.974) + 5.40% (0.026) = 10.55%

Cost of Equity
10.70%

Cost of Debt
 $(4.25\% + 0.5\% + 2\%) (1 - .20) = 5.40\%$

Weights
 E = 97.4% D = 2.6%

On May 1, 2010
 AG Pfd price = 279 HRK
 AG Common = 345 HRK

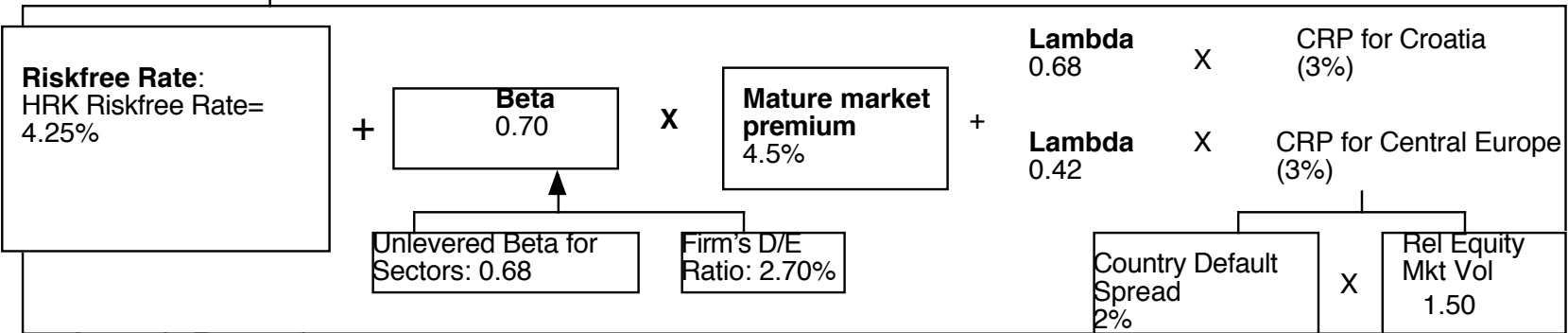

Adris Grupa: 4/2010 (Restructured)

Increased ROIC to cost of capital

Current Cashflow to Firm
 EBIT(1-t) : 436 HRK
 - Nt CpX 3 HRK
 - Chg WC -118 HRK
 = FCFF 551 HRK
 Reinv Rate = (3-118)/436 = -26.35%;
 Tax rate = 17.35%
 Return on capital = 8.72%

Average from 2004-09
70.83%

Reinvestment Rate
70.83%

Expected Growth from new inv.
 $.7083 \times .01054 = 0.0074$
 or 6.86%

Return on Capital
10.54%

Stable Growth
 $g = 4\%$; Beta = 0.80
 Country Premium = 2%
 Cost of capital = 9.65%
 Tax rate = 20.00%
 ROC = 9.94%;
 Reinvestment Rate = $g/ROC = 4/9.65 = 41/47\%$

Terminal Value₅ = $367 / (.0965 - .04) = 6508$ HRK

HKR Cashflows

Op. Assets 4545
 + Cash: 1787
 - Debt 141
 - Minority int 465
 = Equity 5,735
 Value/non-voting 334
 Value/voting 362

| Year | 1 | 2 | 3 | 4 | 5 | |
|----------------|---------|---------|---------|---------|---------|-----|
| EBIT (1-t) | HRK 469 | HRK 503 | HRK 541 | HRK 581 | HRK 623 | 628 |
| - Reinvestment | HRK 332 | HRK 356 | HRK 383 | HRK 411 | HRK 442 | 246 |
| FCFF | HRK 137 | HRK 147 | HRK 158 | HRK 169 | HRK 182 | 367 |

Discount at \$ Cost of Capital (WACC) = 11.12% (.90) + 8.20% (0.10) = 10.55%

Changed mix of debt and equity to optimal

On May 1, 2010
 AG Pfd price = 279 HRK
 AG Common = 345 HRK

Cost of Equity 11.12%

Cost of Debt
 $(4.25\% + 4\% + 2\%) (1 - .20) = 8.20\%$

Weights
 E = 90 % D = 10 %

Riskfree Rate:
 HRK Riskfree Rate = 4.25%

+

Beta
0.75

X

Mature market premium
4.5%

+

Lambda
0.68

X

CRP for Croatia (3%)

Lambda
0.42

X

CRP for Central Europe (3%)

Unlevered Beta for Sectors: 0.68

Firm's D/E Ratio: 11.1%

Country Default Spread 2%

X

Rel Equity Mkt Vol 1.50

Value of Control and the Value of Voting Rights

- Adris Grupa has two classes of shares outstanding: 9.616 million voting shares and 6.748 million non-voting shares.
- To value a non-voting share, we assume that all non-voting shares essentially have to settle for status quo value. All shareholders, common and preferred, get an equal share of the status quo value.

Status Quo Value of Equity = 5,484 million HKR

Value for a non-voting share = $5484 / (9.616 + 6.748) = 334$ HKR/share

- To value a voting share, we first value control in Adris Grup as the difference between the optimal and the status quo value:

Value of control at Adris Grupa = $5,735 - 5484 = 249$ million HKR

- If you assume a 100% probability of change occurring, the value per voting share can be written as:

Value per voting share = $334 \text{ HKR} + 249 / 9.616 = 362$ HKR

- If the probability of control changing is only 40%, the expected value of control and value per voting share can be written as follows:

- ▣ Expected value of control = $249 (.4) = 99.6$ million HKR

- ▣ Value per voting share = $334 \text{ HKR} + 99.6 / 9.616 = 344$ HKR

Indofood Restructured: My valuation (July 2016)

Indofood's revenue growth has been sluggish and its margin decreased slightly in 2015

| | Company | Industry |
|------------------|---------|----------|
| Revenue growth | 2.46% | 7.62% |
| Operating margin | 11.26% | 8.38% |
| Sales to capital | 1.12 | 1.75 |
| ROIC | 9.23% | 12.28% |

Between 1993 and 2015, Indofoods reported a growth rate of 20.14% in revenues, an average operating margin of 13.76% and an average sales to capital ratio of 1.69.

Stable Growth
 $g = 5.04\%$
 Cost of capital = 9.54%
 ROC = 9.54%;
 Reinvestment Rate = $5.04\%/9.54\% = 52.83\%$

Revenue growth of 20.14% a year for 5 years, tapering down to 5.04% in year 10

Pre-tax operating margin increases to 13.76% over time.

Sales to capital ratio of 1.83 for incremental sales

Terminal Value = $7570 / (.0954 - .0504) = 168,226$

| | Base year | 1 | 2 | 3 | 4 | 5 | 6 | 7 | 8 | 9 | 10 | Terminal year |
|-------------------------|------------|---------------|---------------|-------------|-------------|-------------|-------------|-------------|-------------|-------------|-------------|---------------|
| Revenue growth rate | | 20.14% | 20.14% | 20.14% | 20.14% | 20.14% | 17.12% | 14.10% | 11.08% | 8.06% | 5.04% | 5.04% |
| Revenues | IDR 65,557 | IDR 78,760 | IDR 94,622 | IDR 113,679 | IDR 136,574 | IDR 164,081 | IDR 192,171 | IDR 219,267 | IDR 243,562 | IDR 263,193 | IDR 276,458 | IDR 290,392 |
| EBIT (Operating) margin | 11.26% | 11.51% | 11.76% | 12.01% | 12.26% | 12.51% | 12.76% | 13.01% | 13.26% | 13.51% | 13.76% | 13.76% |
| EBIT (Operating income) | IDR 7,383 | IDR 9,067 | IDR 11,129 | IDR 13,654 | IDR 16,746 | IDR 20,528 | IDR 24,523 | IDR 28,528 | IDR 32,297 | IDR 35,558 | IDR 38,041 | \$ 39,957.90 |
| Tax rate | 27.05% | 27.05% | 27.05% | 27.05% | 27.05% | 27.05% | 26.64% | 26.23% | 25.82% | 25.41% | 25.00% | 25.00% |
| EBIT(1-t) | IDR 5,386 | IDR 6,614 | IDR 8,119 | IDR 9,961 | IDR 12,216 | IDR 14,975 | IDR 17,990 | IDR 21,045 | IDR 23,958 | IDR 26,523 | IDR 28,530 | IDR 29,968 |
| - Reinvestment | | IDR 7,813 | IDR 9,386 | IDR 11,276 | IDR 13,547 | IDR 16,276 | IDR 16,622 | IDR 16,033 | IDR 14,376 | IDR 11,616 | IDR 7,849 | IDR 15,832 |
| FCFF | | IDR (1,198) | IDR (1,267) | IDR (1,315) | IDR (1,331) | IDR (1,301) | IDR 1,368 | IDR 5,012 | IDR 9,582 | IDR 14,907 | IDR 20,681 | IDR 14,136 |
| Cost of capital | | 11.63% | 11.63% | 11.63% | 11.63% | 11.63% | 11.21% | 10.79% | 10.37% | 9.96% | 9.54% | 9.54% |
| PV(FCFF) | | \$ (1,073.57) | \$ (1,017.07) | \$ (945.71) | \$ (857.54) | \$ (750.42) | \$ 709.82 | \$ 2,347.09 | \$ 4,065.75 | \$ 5,751.97 | \$ 7,285.26 | |

| | |
|---------------------------------|-------------|
| Value of operating assets = | IDR 126,173 |
| - Debt | IDR 27,793 |
| - Minority interests | IDR 27 |
| + Cash | IDR 13,913 |
| + Non-operating assets | IDR 1,821 |
| Value of equity | IDR 114,087 |
| - Value of options | IDR 7,684 |
| Value of equity in common stock | IDR 106,403 |
| Number of shares | 8.78 |
| Estimated value /share | IDR 12,118 |

Cost of capital = $13.76\% (.705) + 6.55\% (.295) = 11.63\%$

Cost of capital decreases to 9.54% from years 6-10

Cost of equity = 13.76%

Cost of Debt *Rated Baa1*
 $(5.04\% + 2.44\% + 1.25\%)(1 - .25) = 6.55\%$

Weights
 E = 70.5% D = 29.5%

On July 2, 2016, the shares were trading at 7000 IDR/share.

Riskfree Rate:
Riskfree rate = 5.04%

+

Beta
0.95

x

Risk Premium
9.18%

D/E = 41.93%

| Business | Weight | Unlevered Beta |
|---------------------|--------|----------------|
| Food Processing | 81.37% | 0.72 |
| Food Wholesalers | 1.99% | 0.49 |
| Farming/Agriculture | 16.63% | 0.76 |
| Indofood | | 0.72 |

| Country | ERP | Weight |
|-------------------|--------|---------|
| Indonesia | 9.28% | 91.17% |
| Saudi Arabia | 6.90% | 1.45% |
| Vietnam | 12.71% | 0.93% |
| Nigeria | 11.37% | 0.79% |
| Singapore | 6.00% | 0.67% |
| Korea | 6.74% | 0.50% |
| Thailand | 8.38% | 0.48% |
| Rest of the World | 7.45% | 4.00% |
| Total | 9.18% | 100.00% |

Aswath Damodaran



THE DARK SIDE OF VALUATION: VALUING DIFFICULT-TO-VALUE COMPANIES



The fundamental determinants of value...

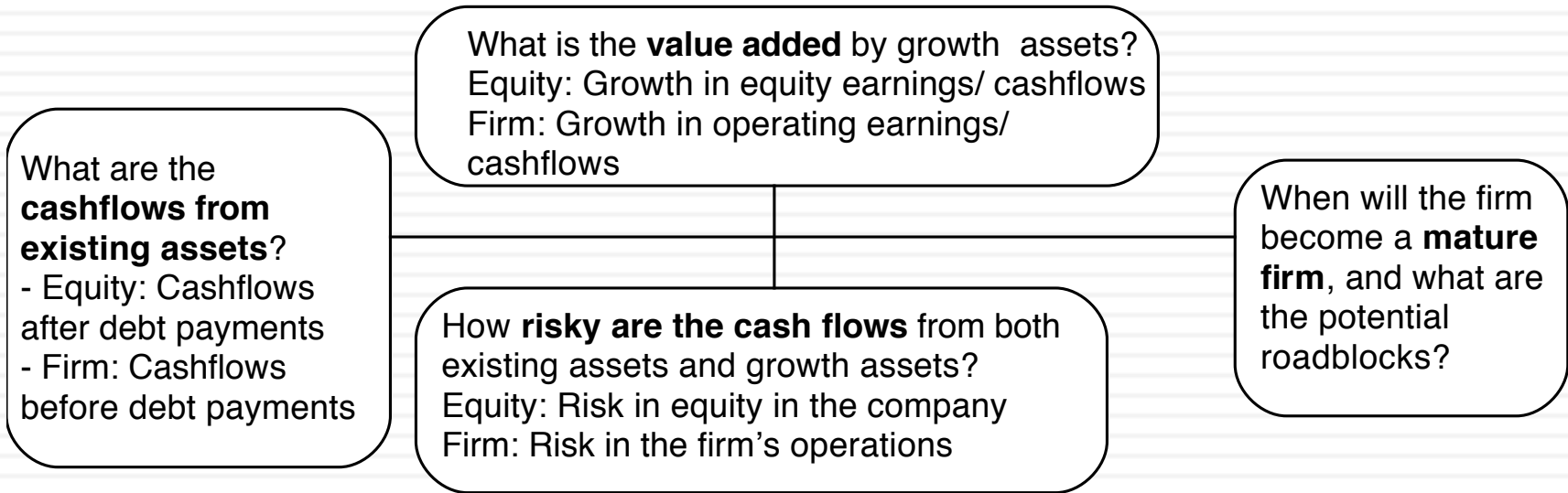

The Dark Side of Valuation...

- Valuing stable, money making companies with consistent and clear accounting statements, a long and stable history and lots of comparable firms is easy to do.
- The true test of your valuation skills is when you have to value “difficult” companies. In particular, the challenges are greatest when valuing:
 - ▣ Young companies, early in the life cycle, in young businesses
 - ▣ Companies that don’t fit the accounting mold
 - ▣ Companies that face substantial truncation risk (default or nationalization risk)

Difficult to value companies...

- Across the life cycle:
 - ▣ Young, growth firms: Limited history, small revenues in conjunction with big operating losses and a propensity for failure make these companies tough to value.
 - ▣ Mature companies in transition: When mature companies change or are forced to change, history may have to be abandoned and parameters have to be reestimated.
 - ▣ Declining and Distressed firms: A long but irrelevant history, declining markets, high debt loads and the likelihood of distress make them troublesome.
- Across sectors
 - ▣ Financial service firms: Opacity of financial statements and difficulties in estimating basic inputs leave us trusting managers to tell us what's going on.
 - ▣ Commodity and cyclical firms: Dependence of the underlying commodity prices or overall economic growth make these valuations susceptible to macro factors.
 - ▣ Firms with intangible assets: Accounting principles are left to the wayside on these firms.
- Across the ownership cycle
 - ▣ Privately owned businesses: Exposure to firm specific risk and illiquidity bedevil valuations.
 - ▣ Venture Capital (VC) and private equity: Different equity investors, with different perceptions of risk.
 - ▣ Closely held public firms: Part private and part public, sharing the troubles of both.

I. The challenge with young companies...

Figure 5.2: Estimation Issues - Young and Start-up Companies

Making judgments on revenues/ profits difficult because you cannot draw on history. If you have no product/ service, it is difficult to gauge market potential or profitability. The company's entire value lies in future growth but you have little to base your estimate on.

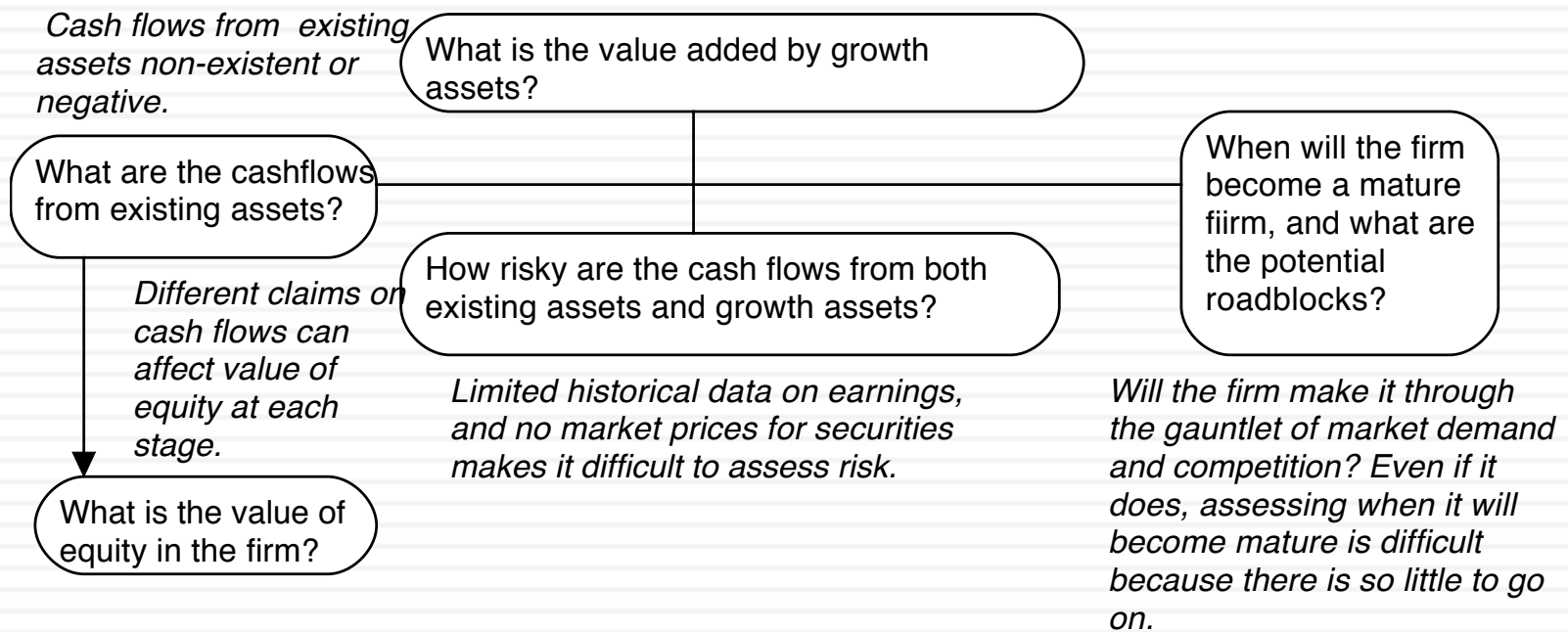

Upping the ante.. Young companies in young businesses...

- When valuing a business, we generally draw on three sources of information
 - ▣ The firm's current financial statement
 - How much did the firm sell?
 - How much did it earn?
 - ▣ The firm's financial history, usually summarized in its financial statements.
 - How fast have the firm's revenues and earnings grown over time?
 - What can we learn about cost structure and profitability from these trends?
 - Susceptibility to macro-economic factors (recessions and cyclical firms)
 - ▣ The industry and comparable firm data
 - What happens to firms as they mature? (Margins.. Revenue growth... Reinvestment needs... Risk)
- It is when valuing these companies that you find yourself tempted by the dark side, where
 - ▣ "Paradigm shifts" happen...
 - ▣ New metrics are invented ...
 - ▣ The story dominates and the numbers lag...

Amazon in January 2000

Sales to capital ratio and expected margin are retail industry average numbers

Stable Growth

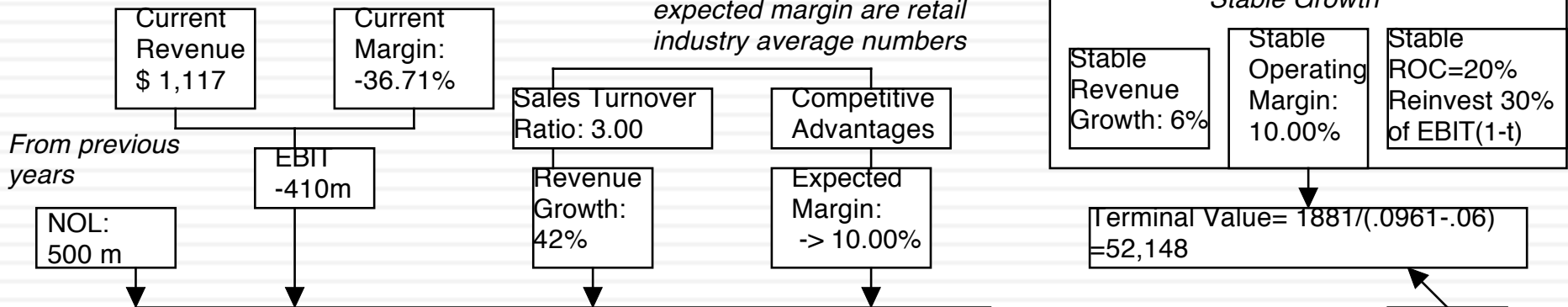

Value of Op Assets \$ 15,170
 + Cash \$ 26
 = Value of Firm \$ 15,196
 - Value of Debt \$ 349
 = Value of Equity \$ 14,847
 - Equity Options \$ 2,892
 Value per share \$ 35.08

All existing options valued as options, using current stock price of \$84.

| | 150.00% | 100.00% | 75.00% | 50.00% | 30.00% | 25.20% | 20.40% | 15.60% | 10.80% | 6.00% | Term. Year |
|------------------|----------|----------|----------|-----------|-----------|-----------|-----------|-----------|-----------|-----------|------------|
| Revenues | \$ 2,793 | \$ 5,585 | \$ 9,774 | \$ 14,661 | \$ 19,059 | \$ 23,862 | \$ 28,729 | \$ 33,211 | \$ 36,798 | \$ 39,006 | \$ 41,346 |
| Operating Margin | -13.35% | -1.68% | 4.16% | 7.08% | 8.54% | 9.27% | 9.64% | 9.82% | 9.91% | 9.95% | 10.00% |
| EBIT | -\$373 | -\$94 | \$407 | \$1,038 | \$1,628 | \$2,212 | \$2,768 | \$3,261 | \$3,646 | \$3,883 | \$4,135 |
| EBIT(1-t) | -\$373 | -\$94 | \$407 | \$871 | \$1,058 | \$1,438 | \$1,799 | \$2,119 | \$2,370 | \$2,524 | \$2,688 |
| - Reinvestment | \$600 | \$967 | \$1,420 | \$1,663 | \$1,543 | \$1,688 | \$1,721 | \$1,619 | \$1,363 | \$961 | \$155 |
| FCFF | -\$931 | -\$1,024 | -\$989 | -\$758 | -\$408 | -\$163 | \$177 | \$625 | \$1,174 | \$1,788 | \$1,881 |

| | 1 | 2 | 3 | 4 | 5 | 6 | 7 | 8 | 9 | 10 | Forever |
|------------------------|--------|--------|--------|--------|--------|--------|--------|--------|--------|--------|---------|
| Cost of Equity | 12.90% | 12.90% | 12.90% | 12.90% | 12.90% | 12.42% | 11.94% | 11.46% | 10.98% | 10.50% | |
| Cost of Debt | 8.00% | 8.00% | 8.00% | 8.00% | 8.00% | 7.80% | 7.75% | 7.67% | 7.50% | 7.00% | |
| After-tax cost of debt | 8.00% | 8.00% | 8.00% | 6.71% | 5.20% | 5.07% | 5.04% | 4.98% | 4.88% | 4.55% | |
| Cost of Capital | 12.84% | 12.84% | 12.84% | 12.83% | 12.81% | 12.13% | 11.62% | 11.08% | 10.49% | 9.61% | |

Cost of Equity 12.90%

Used average interest coverage ratio over next 5 years to get BBB rating.

Cost of Debt 6.5% + 1.5% = 8.0%
 Tax rate = 0% -> 35%

Weights Debt = 1.2% -> 15%

Amazon was trading at \$84 in January 2000.

Pushed debt ratio to retail industry average of 15%.

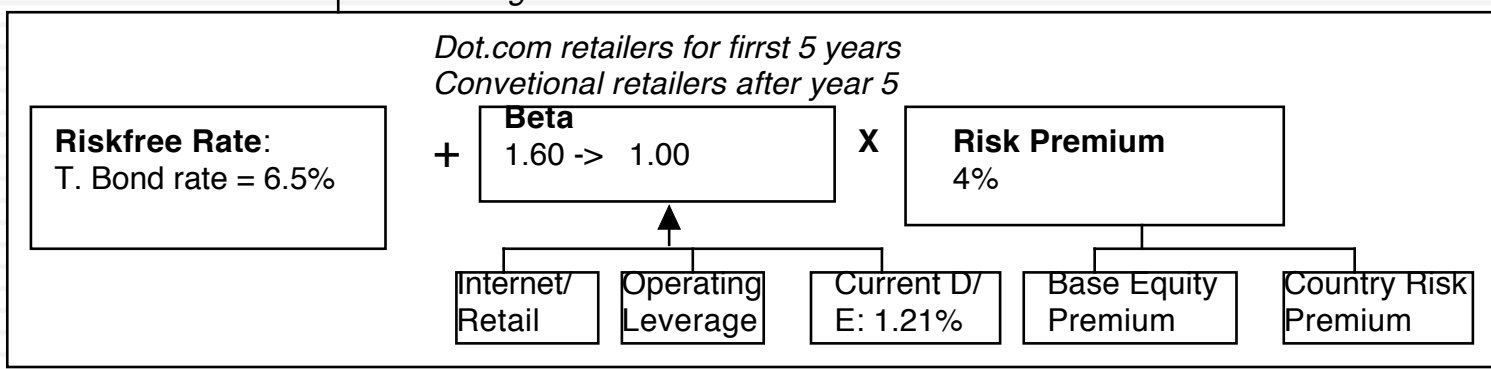

Lesson 1: Don't trust regression betas....

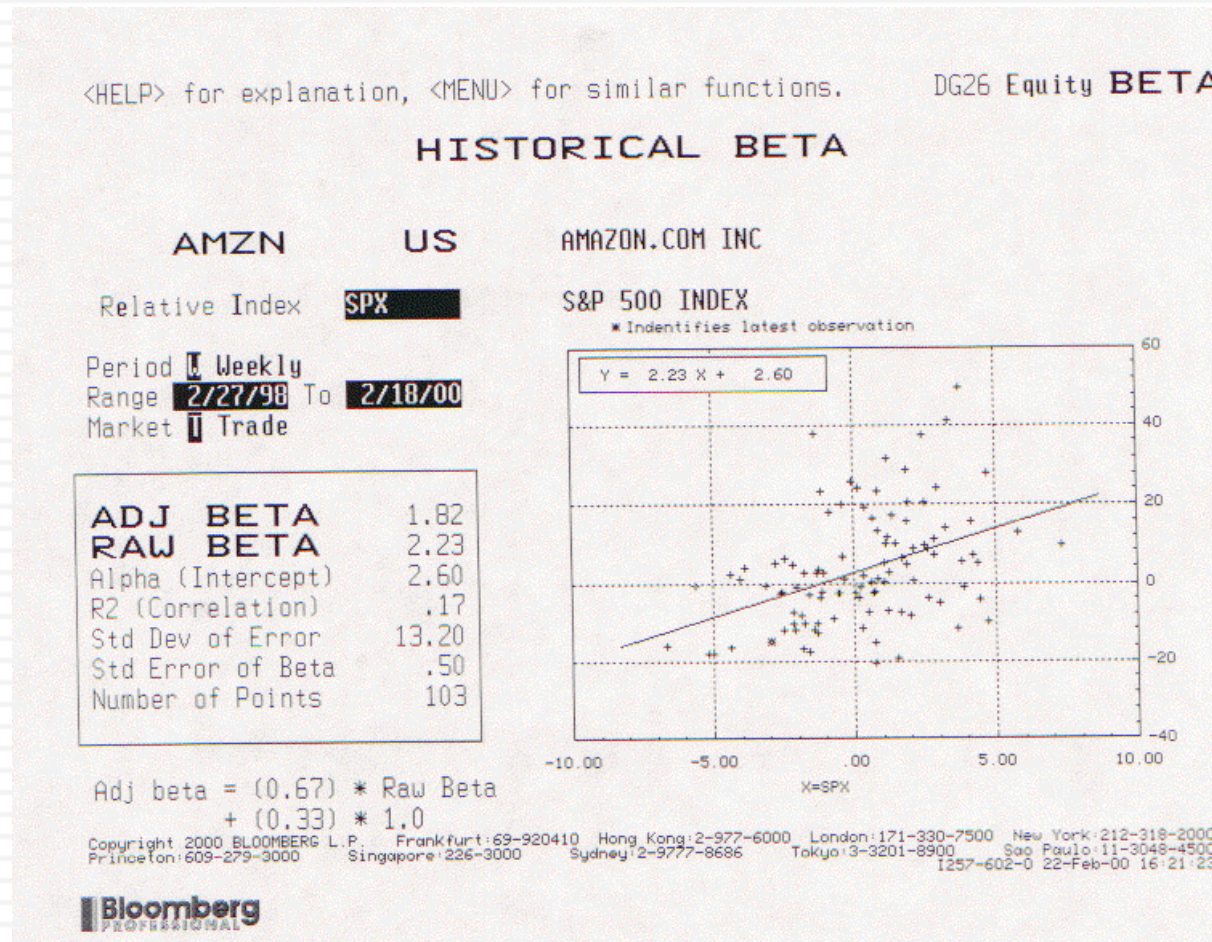

Lesson 2: Work backwards and keep it simple...

| Year | Revenue Growth | Sales | Operating Margin | EBIT | EBIT (1-t) |
|------------|----------------|----------|------------------|---------|------------|
| Tr 12 mths | | \$1,117 | -36.71% | -\$410 | -\$410 |
| 1 | 150.00% | \$2,793 | -13.35% | -\$373 | -\$373 |
| 2 | 100.00% | \$5,585 | -1.68% | -\$94 | -\$94 |
| 3 | 75.00% | \$9,774 | 4.16% | \$407 | \$407 |
| 4 | 50.00% | \$14,661 | 7.08% | \$1,038 | \$871 |
| 5 | 30.00% | \$19,059 | 8.54% | \$1,628 | \$1,058 |
| 6 | 25.20% | \$23,862 | 9.27% | \$2,212 | \$1,438 |
| 7 | 20.40% | \$28,729 | 9.64% | \$2,768 | \$1,799 |
| 8 | 15.60% | \$33,211 | 9.82% | \$3,261 | \$2,119 |
| 9 | 10.80% | \$36,798 | 9.91% | \$3,646 | \$2,370 |
| 10 | 6.00% | \$39,006 | 9.95% | \$3,883 | \$2,524 |
| TY | 6.00% | \$41,346 | 10.00% | \$4,135 | \$2,688 |

Lesson 3: Scaling up is hard to do...

Typically, the revenue growth rate of a newly public company outpaces its industry average for only about five years.

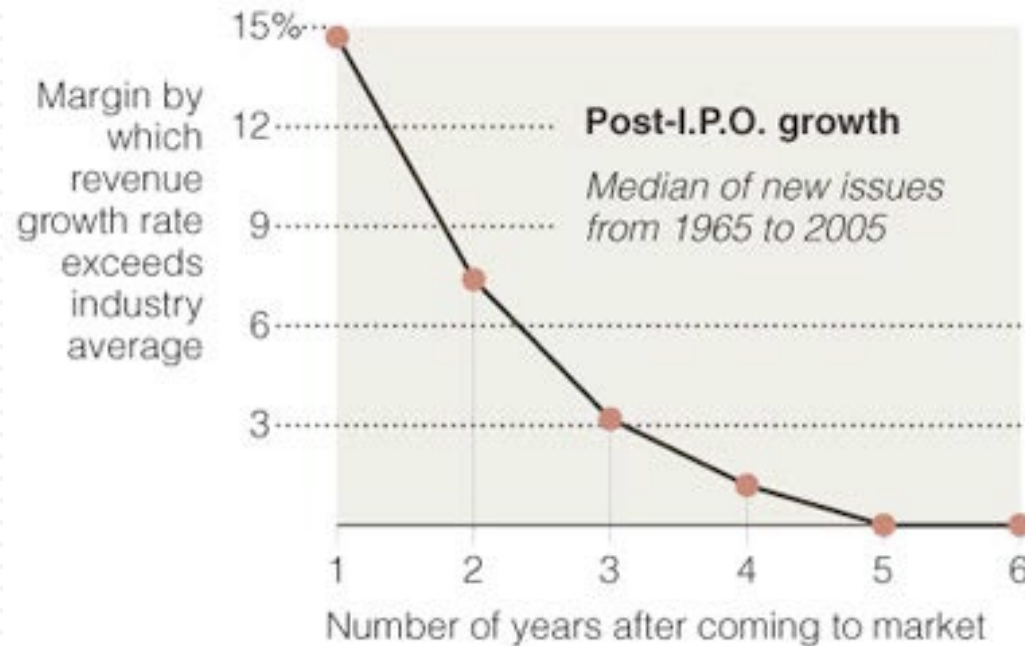

Source: Andrew Metrick

The New York Times

Lesson 4: Don't forget to pay for growth...

| Year | Revenues | Δ Revenue | Sales/Cap | Δ Investment | Invested Capital | EBIT (1-t) | Imputed ROC |
|------------|----------|-----------|-----------|--------------|------------------|------------|-------------|
| Tr 12 mths | \$1,117 | | | | \$ 487 | -\$410 | |
| 1 | \$2,793 | \$1,676 | 3.00 | \$559 | \$ 1,045 | -\$373 | -76.62% |
| 2 | \$5,585 | \$2,793 | 3.00 | \$931 | \$ 1,976 | -\$94 | -8.96% |
| 3 | \$9,774 | \$4,189 | 3.00 | \$1,396 | \$ 3,372 | \$407 | 20.59% |
| 4 | \$14,661 | \$4,887 | 3.00 | \$1,629 | \$ 5,001 | \$871 | 25.82% |
| 5 | \$19,059 | \$4,398 | 3.00 | \$1,466 | \$ 6,467 | \$1,058 | 21.16% |
| 6 | \$23,862 | \$4,803 | 3.00 | \$1,601 | \$ 8,068 | \$1,438 | 22.23% |
| 7 | \$28,729 | \$4,868 | 3.00 | \$1,623 | \$ 9,691 | \$1,799 | 22.30% |
| 8 | \$33,211 | \$4,482 | 3.00 | \$1,494 | \$ 11,185 | \$2,119 | 21.87% |
| 9 | \$36,798 | \$3,587 | 3.00 | \$1,196 | \$ 12,380 | \$2,370 | 21.19% |
| 10 | \$39,006 | \$2,208 | 3.00 | \$736 | \$ 13,116 | \$2,524 | 20.39% |
| TY | \$41,346 | \$2,340 | NA | | Assumed to be = | | 20.00% |

Lesson 5: There are always scenarios where the market price can be justified...

| | | Target pre-tax Operating Margin | | | | |
|---------------------------------------|-----|---------------------------------|----------|-----------|-----------|-----------|
| | | 6% | 8% | 10% | 12% | 14% |
| Compounded annual Revenue Growth rate | 30% | \$ (1.94) | \$ 2.95 | \$ 7.84 | \$ 12.71 | \$ 17.57 |
| | 35% | \$ 1.41 | \$ 8.37 | \$ 15.33 | \$ 22.27 | \$ 29.21 |
| | 40% | \$ 6.10 | \$ 15.93 | \$ 25.74 | \$ 35.54 | \$ 45.34 |
| | 45% | \$ 12.59 | \$ 26.34 | \$ 40.05 | \$ 53.77 | \$ 67.48 |
| | 50% | \$ 21.47 | \$ 40.50 | \$ 59.52 | \$ 78.53 | \$ 97.54 |
| | 55% | \$ 33.47 | \$ 59.60 | \$ 85.72 | \$ 111.84 | \$ 137.95 |
| | 60% | \$ 49.53 | \$ 85.10 | \$ 120.66 | \$ 156.22 | \$ 191.77 |

Lesson 6: Don't forget to mop up...

- Watch out for “other” equity claims: If you buy equity in a young, growth company, watch out for other (often hidden) claims on the equity that don't take the form of common shares. In particular, watch for options granted to managers, employees, venture capitalists and others (you will be surprised...).
 - ▣ Value these options as options (not at exercise value)
 - ▣ Take into consideration expectations of future option grants when computing expected future earnings/cash flows.
- Not all shares are equal: If there are differences in cash flow claims (dividends or liquidation) or voting rights across shares, value these differences.
 - ▣ Voting rights matter even at well run companies

Lesson 7: You will be wrong 100% of the time... and it really is not (always) your fault...

- No matter how careful you are in getting your inputs and how well structured your model is, your estimate of value will change both as new information comes out about the company, the business and the economy.
- As information comes out, you will have to adjust and adapt your model to reflect the information. Rather than be defensive about the resulting changes in value, recognize that this is the essence of risk.
- A test: If your valuations are unbiased, you should find yourself increasing estimated values as often as you are decreasing values. In other words, there should be equal doses of good and bad news affecting valuations (at least over time).

And the market is often “more wrong”

Amazon: Value and Price

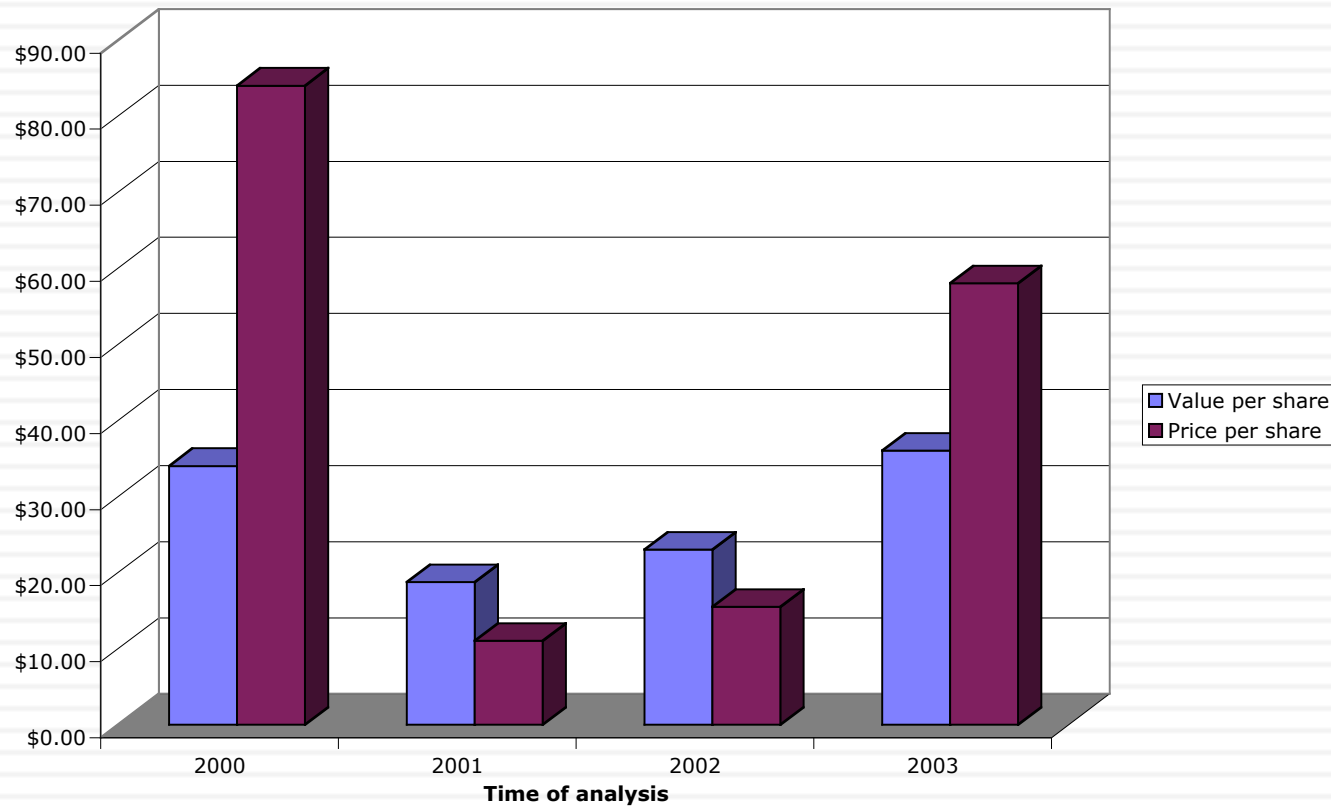

Valuing an IPO

□ Valuation issues:

- Use of the proceeds from the offering: The proceeds from the offering can be held as cash by the firm to cover future investment needs, paid to existing equity investors who want to cash out or used to pay down debt.
- Warrants/ Special deals with prior equity investors: If venture capitalists and other equity investors from earlier iterations of fund raising have rights to buy or sell their equity at pre-specified prices, it can affect the value per share offered to the public.

□ Pricing issues:

- Institutional set-up: Most IPOs are backed by investment banking guarantees on the price, which can affect how they are priced.
- Follow-up offerings: The proportion of equity being offered at initial offering and subsequent offering plans can affect pricing.

Alibaba: Pre-IPO valuation - September 2, 2014 (in US \$)

| | T12M | 2012-13 |
|--------------------|---------|---------|
| Revenues | \$9,268 | \$4,821 |
| Operating Income | \$4,702 | \$1,777 |
| Effective tax rate | 11.92% | |
| Operating Margin | 50.73% | |

Revenue growth of 25% a year for 5 years, tapering down to 2.63% in year 10

Pre-tax operating margin decreases to 40% over time & tax rate rises to 25%

Sales to capital ratio maintained at 2.00

Stable Growth
 $g = 2.41\%$
 Cost of capital = 8%
 ROC = 8%;
 Reinvestment Rate = $2.41\%/8\% = 30.125\%$

Terminal Value₁₀ = $10,353 / (.08 - 0.0241) = \$185,198$

| | 1 | 2 | 3 | 4 | 5 | 6 | 7 | 8 | 9 | 10 |
|-------------------------|-----------|-----------|-----------|-----------|-----------|-----------|-----------|-----------|-----------|-----------|
| Revenue growth rate | 25.00% | 25.00% | 25.00% | 25.00% | 25.00% | 20.48% | 15.96% | 11.45% | 6.93% | 2.41% |
| Revenues | \$ 11,585 | \$ 14,481 | \$ 18,101 | \$ 22,626 | \$ 28,283 | \$ 34,075 | \$ 39,515 | \$ 44,038 | \$ 47,089 | \$ 48,224 |
| EBIT (Operating margin) | 49.66% | 48.59% | 47.51% | 46.44% | 45.37% | 44.29% | 43.22% | 42.15% | 41.07% | 40.00% |
| EBIT (Operating income) | \$ 5,753 | \$ 7,035 | \$ 8,600 | \$ 10,507 | \$ 12,831 | \$ 15,093 | \$ 17,078 | \$ 18,560 | \$ 19,341 | \$ 19,290 |
| Tax rate | 11.92% | 11.92% | 11.92% | 11.92% | 11.92% | 14.54% | 17.15% | 19.77% | 22.38% | 25.00% |
| EBIT(1-t) | \$ 5,067 | \$ 6,197 | \$ 7,575 | \$ 9,255 | \$ 11,301 | \$ 12,899 | \$ 14,149 | \$ 14,891 | \$ 15,012 | \$ 14,467 |
| - Reinvestment | \$ 1,158 | \$ 1,448 | \$ 1,810 | \$ 2,263 | \$ 2,828 | \$ 2,896 | \$ 2,720 | \$ 2,261 | \$ 1,525 | \$ 567 |
| FCFF | \$ 3,908 | \$ 4,749 | \$ 5,765 | \$ 6,992 | \$ 8,473 | \$ 10,002 | \$ 11,429 | \$ 12,630 | \$ 13,486 | \$ 13,900 |

Term yr
 EBIT (1-t) \$14,816
 - Reinv 4,463
 FCFF 10,353

Operating assets \$137,386
 + Cash 9330
 - Debt 10068
 + Equity investments 2,087
 + Alipay provision 3,000
 + IPO Proceeds (est) 20,000
 - Options 696
 Value of equity 161,039
 Value per share \$65.98

Cost of capital = $8.90\% (.943) + 3.00\% (.057) = 8.56\%$

Cost of capital decreases to 8% from years 6-10

Cost of Equity
8.90%

Cost of Debt
4% (1-.25) = 3.00%

Weights
E = 94.3% D = 5.7%

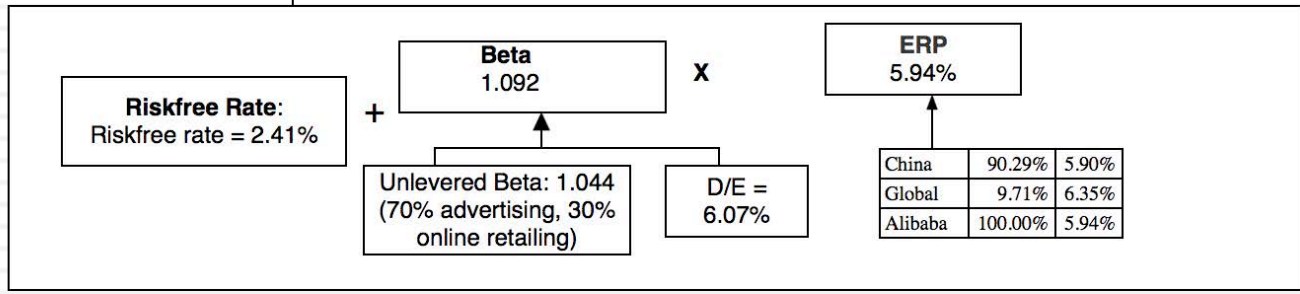

Two days after this valuation, the company (and its bankers) valued itself at about \$155 billion and the shares at \$63 apiece. The offering price was raised to \$69 and the opening price was \$93/share.

II. Mature Companies in transition..

- Mature companies are generally the easiest group to value. They have long, established histories that can be mined for inputs. They have investment policies that are set and capital structures that are stable, thus making valuation more grounded in past data.
- However, this stability in the numbers can mask real problems at the company. The company may be set in a process, where it invests more or less than it should and does not have the right financing mix. In effect, the policies are consistent, stable and bad.
- If you expect these companies to change or as is more often the case to have change thrust upon them,

The perils of valuing mature companies...

Figure 7.1: Estimation Issues - Mature Companies

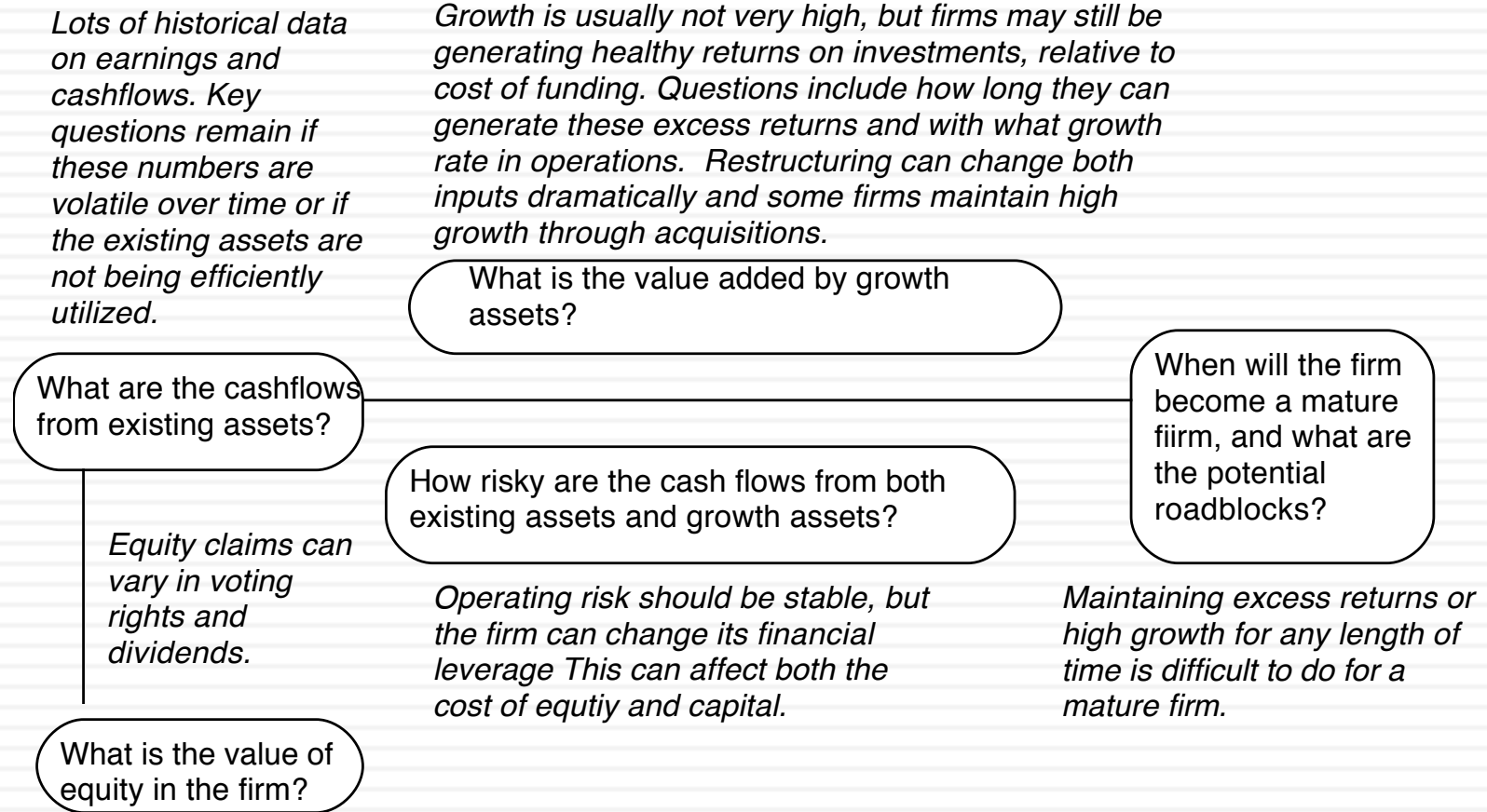

Hormel Foods: The Value of Control Changing

Hormel Foods sells packaged meat and other food products and has been in existence as a publicly traded company for almost 80 years. In 2008, the firm reported after-tax operating income of \$315 million, reflecting a compounded growth of 5% over the previous 5 years.

The Status Quo

Run by existing management, with conservative reinvestment policies (reinvestment rate = 14.34% and debt ratio = 10.4%.

Anemic growth rate and short growth period, due to reinvestment policy

Low debt ratio affects cost of capital

| Year | Operating income after taxes | Expected growth rate | ROC | Reinvestment Rate | Reinvestment | FCFF | Cost of capital | Present Value |
|---------------------------------|------------------------------|----------------------|--------|-------------------|--------------|---------|-----------------|---------------|
| Trailing 12 months | \$315 | | | | | | | |
| 1 | \$324 | 2.75% | 14.34% | 19.14% | \$62 | \$262 | 6.79% | \$245 |
| 2 | \$333 | 2.75% | 14.34% | 19.14% | \$64 | \$269 | 6.79% | \$236 |
| 3 | \$342 | 2.75% | 14.34% | 19.14% | \$65 | \$276 | 6.79% | \$227 |
| Beyond | \$350 | 2.35% | 7.23% | 32.52% | \$114 | \$4,840 | 7.23% | \$3,974 |
| Value of operating assets | | | | | | | | \$4,682 |
| (Add) Cash | | | | | | | | \$155 |
| (Subtract) Debt | | | | | | | | \$491 |
| (Subtract) Management Options | | | | | | | | \$53 |
| Value of equity in common stock | | | | | | | | \$4,293 |
| Value per share | | | | | | | | \$31.91 |

New and better management

More aggressive reinvestment which increases the reinvestment rate (to 40%) and length of growth (to 5 years), and higher debt ratio (20%).

Operating Restructuring ①

Expected growth rate = ROC * Reinvestment Rate
 Expected growth rate (status quo) = 14.34% * 19.14% = 2.75%
 Expected growth rate (optimal) = 14.00% * 40% = 5.60%
 ROC drops, reinvestment rises and growth goes up.

Financial restructuring ②

Cost of capital = Cost of equity (1-Debt ratio) + Cost of debt (Debt ratio)
 Status quo = 7.33% (1-.104) + 3.60% (1-.40) (.104) = 6.79%
 Optimal = 7.75% (1-.20) + 3.60% (1-.40) (.20) = 6.63%
 Cost of equity rises but cost of capital drops.

| Year | Operating income after taxes | Expected growth rate | ROC | Reinvestment Rate | Reinvestment | FCFF | Cost of capital | Present Value |
|---------------------------------|------------------------------|----------------------|--------|-------------------|--------------|---------|-----------------|---------------|
| Trailing 12 months | \$315 | | | | | | | |
| 1 | \$333 | 5.60% | 14.00% | 40.00% | \$133 | \$200 | 6.63% | \$187 |
| 2 | \$351 | 5.60% | 14.00% | 40.00% | \$141 | \$211 | 6.63% | \$185 |
| 3 | \$371 | 5.60% | 14.00% | 40.00% | \$148 | \$223 | 6.63% | \$184 |
| 4 | \$392 | 5.60% | 14.00% | 40.00% | \$260 | \$235 | 6.63% | \$182 |
| 5 | \$414 | 5.60% | 14.00% | 40.00% | \$223 | \$248 | 6.63% | \$180 |
| Beyond | \$423 | 2.35% | 6.74% | 34.87% | \$148 | \$6,282 | 6.74% | \$4,557 |
| Value of operating assets | | | | | | | | \$5,475 |
| (Add) Cash | | | | | | | | \$155 |
| (Subtract) Debt | | | | | | | | \$491 |
| (Subtract) Management Options | | | | | | | | \$53 |
| Value of equity in common stock | | | | | | | | \$5,085 |
| Value per share | | | | | | | | \$37.80 |

Aswath Damodaran

Probability of management change = 10%
 Expected value = \$31.91 (.90) + \$37.80 (.10) = \$32.50
 ③
 ④

Lesson 1: Cost cutting and increased efficiency are easier accomplished on paper than in practice...

Cost-synergy estimation is better, but there are patterns emerging in the errors

Mergers achieving stated percentage of expected cost savings, percent $N = 92$

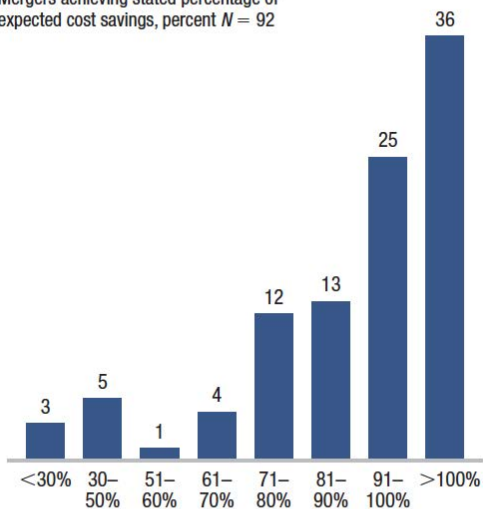

Typical sources of estimation error

- Underestimating one-time costs
- Using benchmarks from noncomparable situations
- Not sanity-checking management estimates against precedent transactions
- Failing to ground estimates in bottom-up analysis (e.g., location-by-location review of overlaps)

Source: McKinsey (2002) Postmerger Management Practice client survey; client case studies

Lesson 2: Increasing growth is not always an option (or at least not a good option)

**Modes of organic growth vary in value creation intensity—
consumer goods industry**

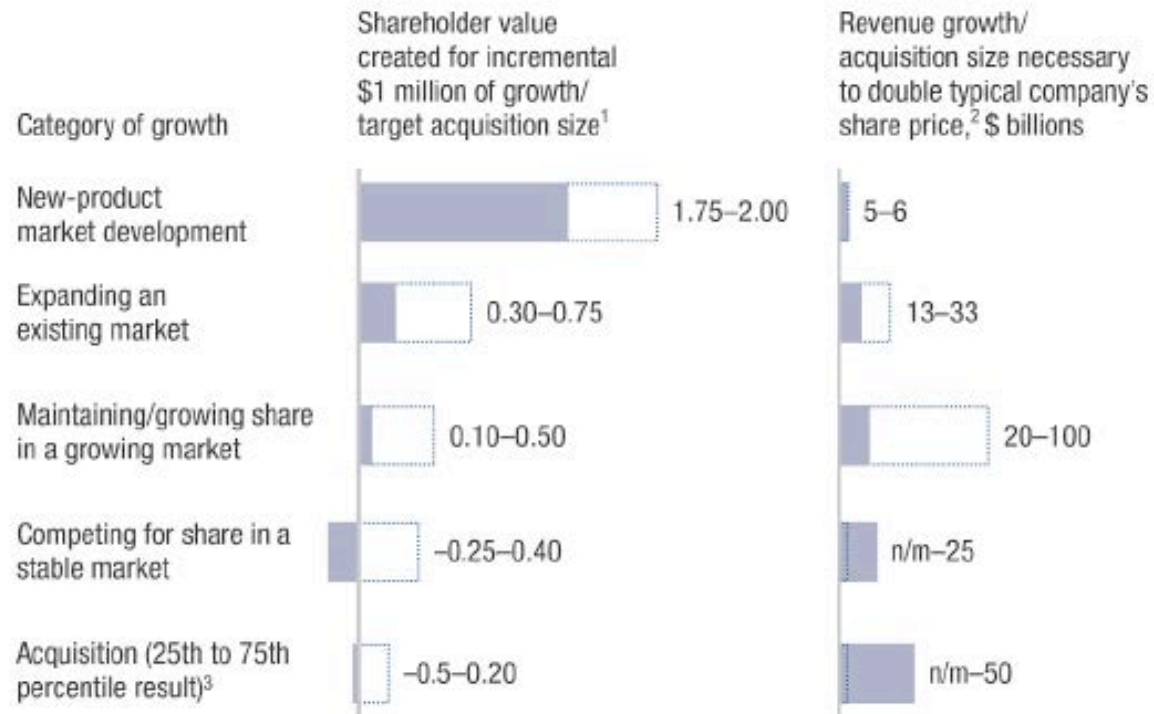

Lesson 3: Financial leverage is a double-edged sword..

Exhibit 7.1: Optimal Financing Mix: Hormel Foods in January 2009

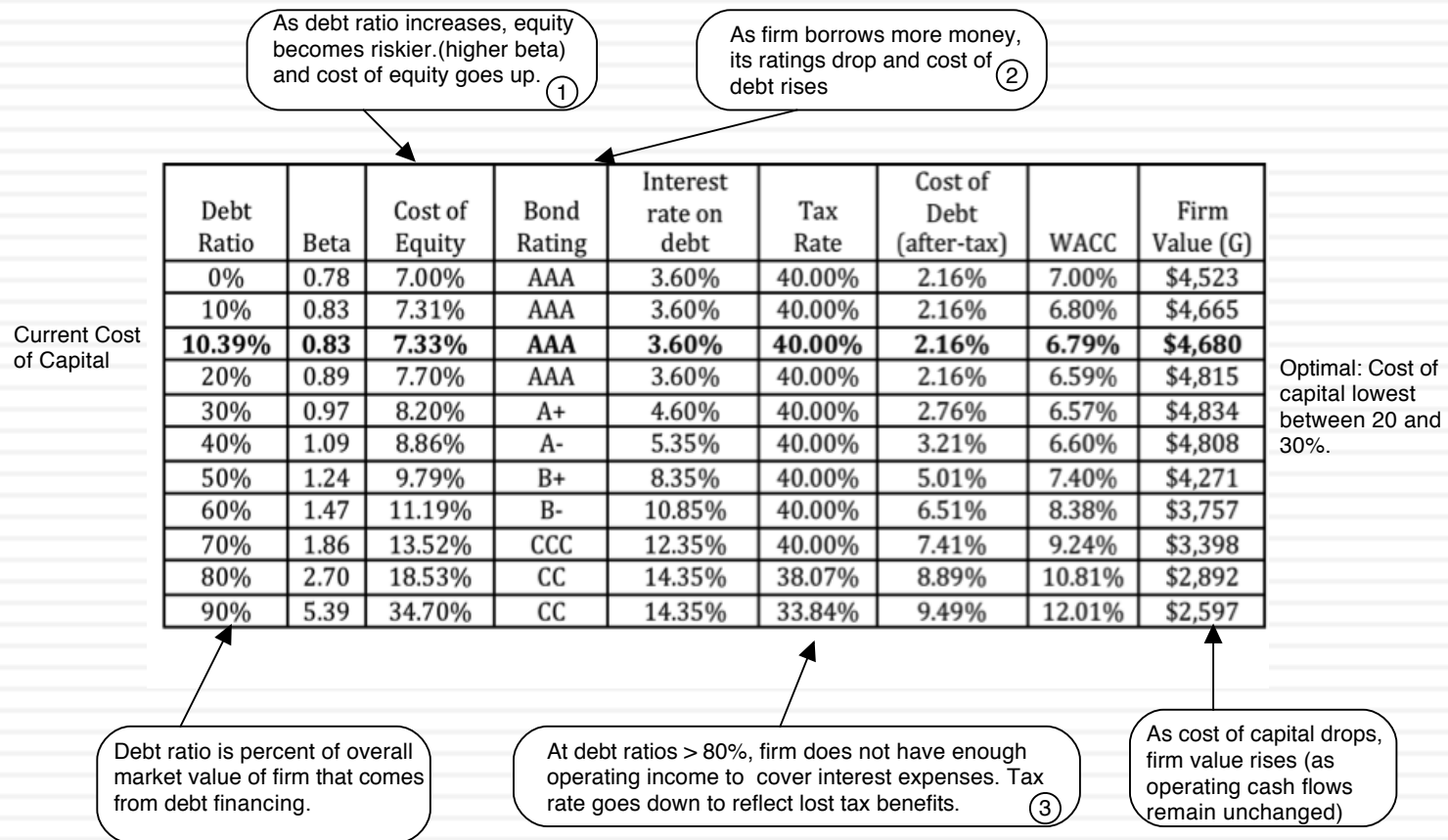

III. Dealing with decline and distress...

Historical data often reflects flat or declining revenues and falling margins. Investments often earn less than the cost of capital.

Growth can be negative, as firm sheds assets and shrinks. As less profitable assets are shed, the firm's remaining assets may improve in quality.

What is the value added by growth assets?

What are the cashflows from existing assets?

Underfunded pension obligations and litigation claims can lower value of equity. Liquidation preferences can affect value of equity

What is the value of equity in the firm?

How risky are the cash flows from both existing assets and growth assets?

Depending upon the risk of the assets being divested and the use of the proceeds from the divestiture (to pay dividends or retire debt), the risk in both the firm and its equity can change.

When will the firm become a mature firm, and what are the potential roadblocks?

There is a real chance, especially with high financial leverage, that the firm will not make it. If it is expected to survive as a going concern, it will be as a much smaller entity.

Dealing with the “downside” of Distress

- A DCF valuation values a firm as a going concern. If there is a significant likelihood of the firm failing before it reaches stable growth and if the assets will then be sold for a value less than the present value of the expected cashflows (a distress sale value), DCF valuations will understate the value of the firm.
- Value of Equity = DCF value of equity (1 - Probability of distress) + Distress sale value of equity (Probability of distress)
- There are three ways in which we can estimate the probability of distress:
 - Use the bond rating to estimate the cumulative probability of distress over 10 years
 - Estimate the probability of distress with a probit
 - Estimate the probability of distress by looking at market value of bonds..
- The distress sale value of equity is usually best estimated as a percent of book value (and this value will be lower if the economy is doing badly and there are other firms in the same business also in distress).

Current Revenue
\$ 4,390

Current Margin:
4.76%

EBIT
\$ 209m

Reinvestment:
Capital expenditures include cost of new casinos and working capital

Extended reinvestment break, due to investment in past

Industry average

Expected Margin:
-> 17%

Stable Growth
Stable Revenue Growth: 3%
Stable Operating Margin: 17%
Stable ROC=10%
Reinvest 30% of EBIT(1-t)

Terminal Value= $758 \cdot (0.0743 - 0.03)$
= \$ 17,129

| | | | | | | | | | | |
|-----------------|---------|---------|---------|---------|---------|---------|---------|---------|---------|---------|
| Revenues | \$4,434 | \$4,523 | \$5,427 | \$6,513 | \$7,815 | \$8,206 | \$8,616 | \$9,047 | \$9,499 | \$9,974 |
| Oper margin | 5.81% | 6.86% | 7.90% | 8.95% | 10% | 11.40% | 12.80% | 14.20% | 15.60% | 17% |
| EBIT | \$258 | \$310 | \$429 | \$583 | \$782 | \$935 | \$1,103 | \$1,285 | \$1,482 | \$1,696 |
| Tax rate | 26.0% | 26.0% | 26.0% | 26.0% | 26.0% | 28.4% | 30.8% | 33.2% | 35.6% | 38.00% |
| EBIT * (1 - t) | \$191 | \$229 | \$317 | \$431 | \$578 | \$670 | \$763 | \$858 | \$954 | \$1,051 |
| - Reinvestment | -\$19 | -\$11 | \$0 | \$22 | \$58 | \$67 | \$153 | \$215 | \$286 | \$350 |
| FCFF | \$210 | \$241 | \$317 | \$410 | \$520 | \$603 | \$611 | \$644 | \$668 | \$701 |
| Beta | 3.14 | 3.14 | 3.14 | 3.14 | 3.14 | 2.75 | 2.36 | 1.97 | 1.59 | 1.20 |
| Cost of equity | 21.82% | 21.82% | 21.82% | 21.82% | 21.82% | 19.50% | 17.17% | 14.85% | 12.52% | 10.20% |
| Cost of debt | 9% | 9% | 9% | 9% | 9% | 8.70% | 8.40% | 8.10% | 7.80% | 7.50% |
| Debt/ratio | 73.50% | 73.50% | 73.50% | 73.50% | 73.50% | 68.80% | 64.10% | 59.40% | 54.70% | 50.00% |
| Cost of capital | 9.88% | 9.88% | 9.88% | 9.88% | 9.88% | 9.79% | 9.50% | 9.01% | 8.32% | 7.43% |

Term. Year
\$10,273
17%
\$ 1,746
38%
\$1,083
\$ 325
\$758

Forever

Value of Op Assets \$ 9,793
+ Cash & Non-op \$ 3,040
= Value of Firm \$12,833
- Value of Debt \$ 7,565
= Value of Equity \$ 5,268

Value per share \$ 8.12

Cost of Equity
21.82%

Cost of Debt
3%+6%= 9%
9% (1-.38)=5.58%

Weights
Debt= 73.5% ->50%

Riskfree Rate:
T. Bond rate = 3%

+ Beta
3.14-> 1.20

x Risk Premium
6%

Aswath Damodaran

Casino
1.15

Current
D/E: 277%

Base Equity
Premium

Country Risk
Premium

Las Vegas Sands
February 2009
Trading @ \$4.25

Adjusting the value of LVS for distress..

- In February 2009, LVS was rated B+ by S&P. Historically, 28.25% of B+ rated bonds default within 10 years. LVS has a 6.375% bond, maturing in February 2015 (7 years), trading at \$529. If we discount the expected cash flows on the bond at the riskfree rate, we can back out the probability of distress from the bond price:

$$529 = \sum_{t=1}^{t=7} \frac{63.75(1 - \pi_{\text{Distress}})^t}{(1.03)^t} + \frac{1000(1 - \pi_{\text{Distress}})^7}{(1.03)^7}$$

- Solving for the probability of bankruptcy, we get:
- π_{Distress} = Annual probability of default = 13.54%
 - Cumulative probability of surviving 10 years = $(1 - .1354)^{10} = 23.34\%$
 - Cumulative probability of distress over 10 years = $1 - .2334 = .7666$ or 76.66%
- If LVS is becomes distressed:
 - Expected distress sale proceeds = \$2,769 million < Face value of debt
 - Expected equity value/share = \$0.00
- Expected value per share = $\$8.12 (1 - .7666) + \$0.00 (.7666) = \$1.92$

The “sunny” side of distress: Equity as a call option to liquidate the firm

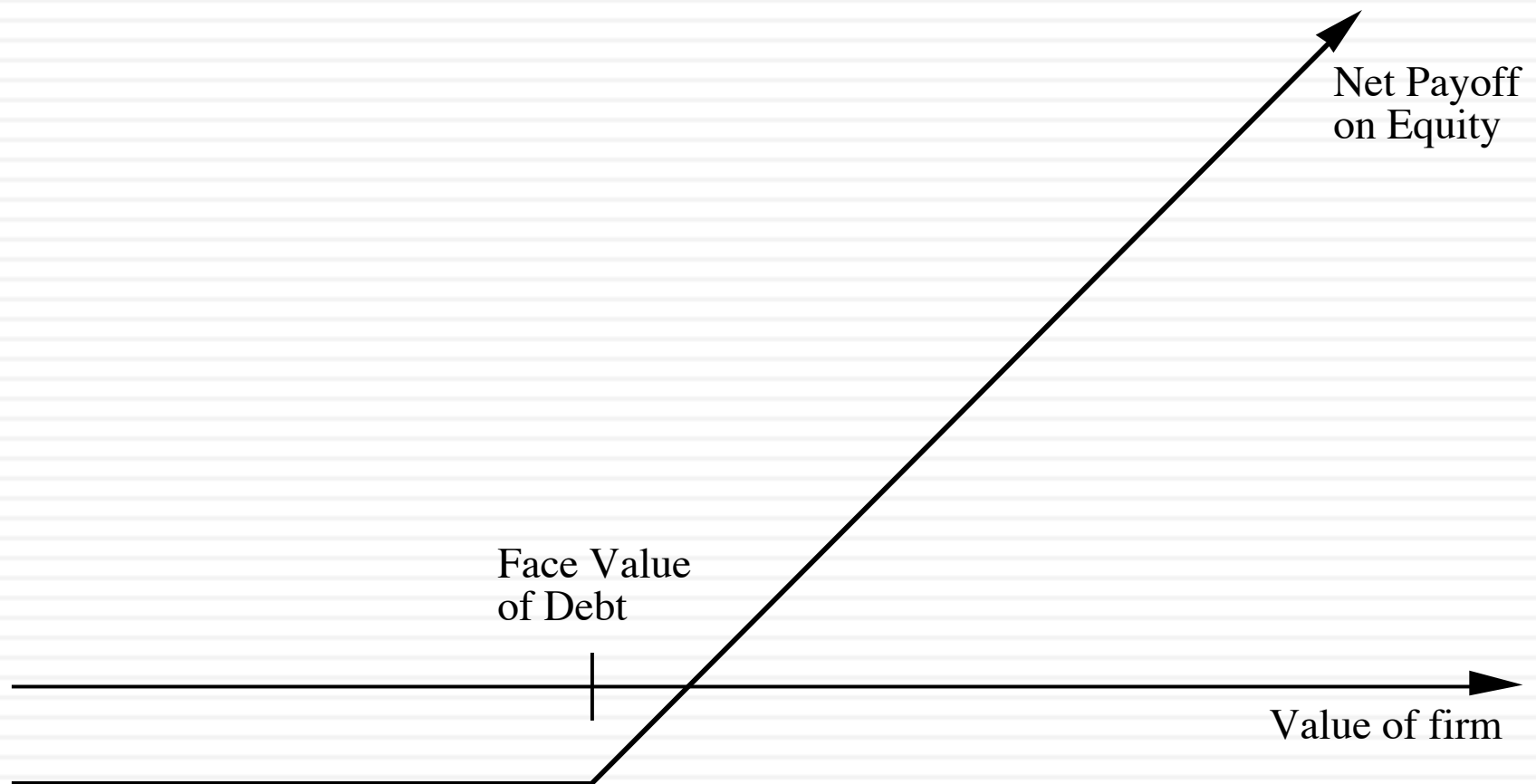

Application to valuation: A simple example

- Assume that you have a firm whose assets are currently valued at \$100 million and that the standard deviation in this asset value is 40%.
- Further, assume that the face value of debt is \$80 million (It is zero coupon debt with 10 years left to maturity).
- If the ten-year treasury bond rate is 10%,
 - ▣ how much is the equity worth?
 - ▣ What should the interest rate on debt be?

Model Parameters & Valuation

□ The inputs

- Value of the underlying asset = S = Value of the firm = \$ 100 million
- Exercise price = K = Face Value of outstanding debt = \$ 80 million
- Life of the option = t = Life of zero-coupon debt = 10 years
- Variance in the value of the underlying asset = σ^2 = Variance in firm value = 0.16
- Riskless rate = r = Treasury bond rate corresponding to option life = 10%

□ The output

- The Black-Scholes model provides the following value for the call:
 - $d1 = 1.5994$ $N(d1) = 0.9451$
 - $d2 = 0.3345$ $N(d2) = 0.6310$
- Value of the call = $100 (0.9451) - 80 \exp^{(-0.10)(10)} (0.6310) = \75.94 million
- Value of the outstanding debt = $\$100 - \$75.94 = \$24.06$ million
- Interest rate on debt = $(\$ 80 / \$24.06)^{1/10} - 1 = 12.77\%$

Firm value drops..

- Assume now that a catastrophe wipes out half the value of this firm (the value drops to \$ 50 million), while the face value of the debt remains at \$ 80 million.
- The inputs
 - Value of the underlying asset = S = Value of the firm = \$ 50 million
 - All the other inputs remain unchanged
- The output
 - Based upon these inputs, the Black-Scholes model provides the following value for the call:
 - $d1 = 1.0515$ $N(d1) = 0.8534$
 - $d2 = -0.2135$ $N(d2) = 0.4155$
 - Value of the call = $50 (0.8534) - 80 \exp^{(-0.10)(10)} (0.4155) = \30.44 million
 - Value of the bond = $\$50 - \$30.44 = \$19.56$ million

Equity value persists .. As firm value declines..

Value of Equity as Firm Value Changes

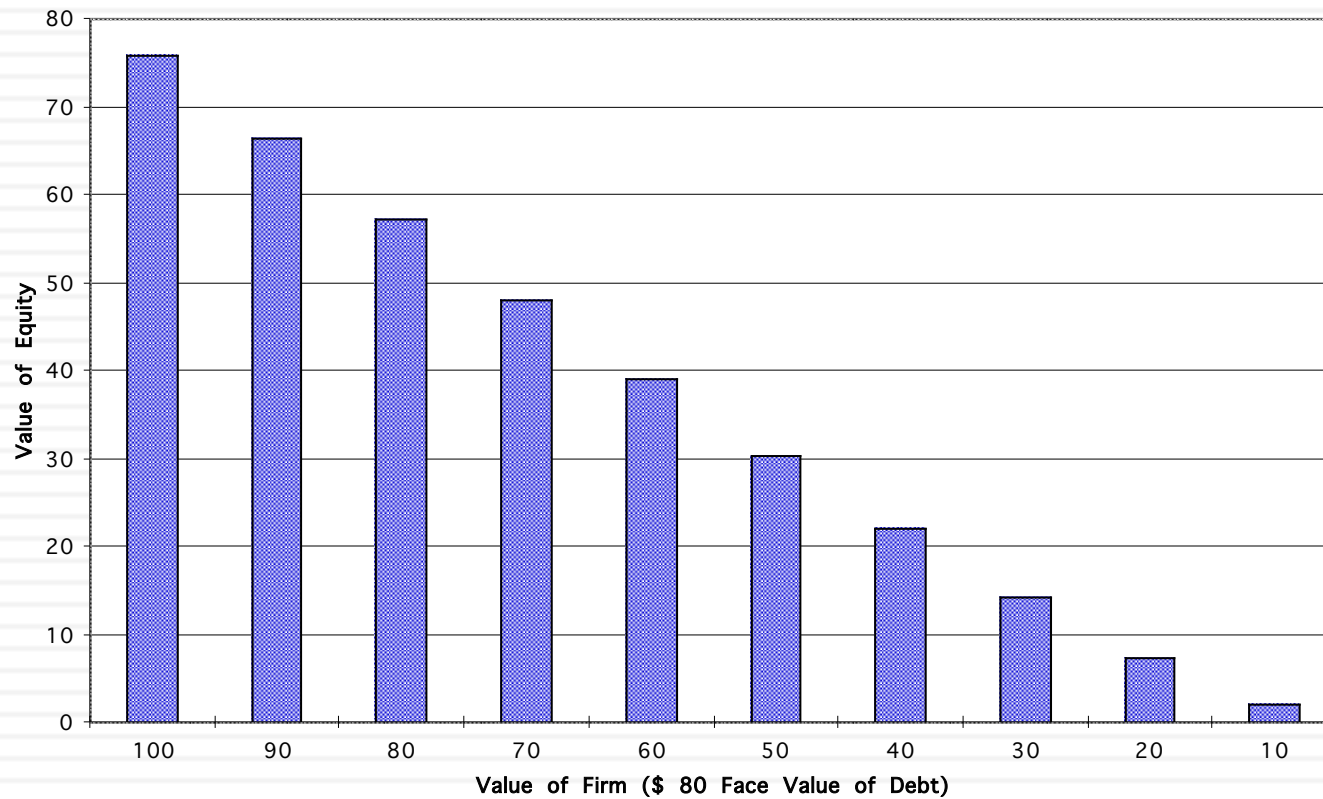

IV. Valuing Financial Service Companies

Existing assets are usually financial assets or loans, often marked to market. Earnings do not provide much information on underlying risk.

Defining capital expenditures and working capital is a challenge. Growth can be strongly influenced by regulatory limits and constraints. Both the amount of new investments and the returns on these investments can change with regulatory changes.

What are the cashflows from existing assets?

What is the value added by growth assets?

When will the firm become a mature firm, and what are the potential roadblocks?

Preferred stock is a significant source of capital.

How risky are the cash flows from both existing assets and growth assets?

What is the value of equity in the firm?

For financial service firms, debt is raw material rather than a source of capital. It is not only tough to define but if defined broadly can result in high financial leverage, magnifying the impact of small operating risk changes on equity risk.

In addition to all the normal constraints, financial service firms also have to worry about maintaining capital ratios that are acceptable to regulators. If they do not, they can be taken over and shut down.

CIB Egypt in December 2015

Valuation in Egyptian Pounds

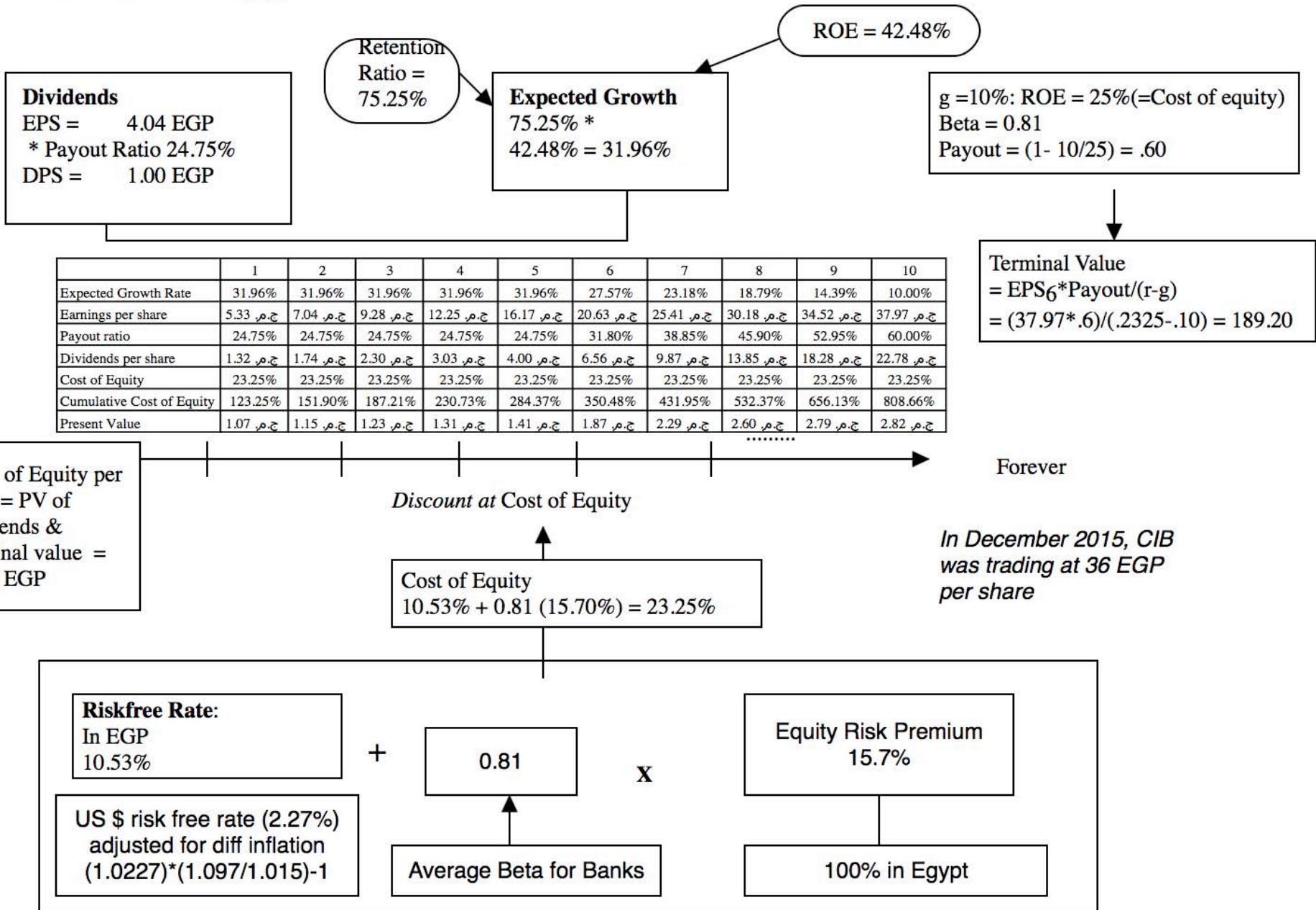

Lesson 1: Financial service companies are opaque...

- With financial service firms, we enter into a Faustian bargain. They tell us very little about the quality of their assets (loans, for a bank, for instance are not broken down by default risk status) but we accept that in return for assets being marked to market (by accountants who presumably have access to the information that we don't have).
- In addition, estimating cash flows for a financial service firm is difficult to do. So, we trust financial service firms to pay out their cash flows as dividends. Hence, the use of the dividend discount model.

Lesson 2: For financial service companies, book value matters...

- The book value of assets and equity is mostly irrelevant when valuing non-financial service companies. After all, the book value of equity is a historical figure and can be nonsensical. (The book value of equity can be negative and is so for more than a 1000 publicly traded US companies)
- With financial service firms, book value of equity is relevant for two reasons:
 - Since financial service firms mark to market, the book value is more likely to reflect what the firms own right now (rather than a historical value)
 - The regulatory capital ratios are based on book equity. Thus, a bank with negative or even low book equity will be shut down by the regulators.
- From a valuation perspective, it therefore makes sense to pay heed to book value. In fact, you can argue that reinvestment for a bank is the amount that it needs to add to book equity to sustain its growth ambitions and safety requirements:
 - $FCFE = \text{Net Income} - \text{Reinvestment in regulatory capital (book equity)}$

2d. Deutsche Bank: March 2009

Last 2 years

| | 2007 | 2008 |
|------------------------|----------|---------|
| Net Income | 3,954 m | -3,855m |
| Dividends | 2,146 m | 285 m |
| Risk adjusted assets = | 312,882m | |
| Book Equity = | 31,914 m | |
| Regulatory Capital = | | |

Normalized
Net Income
for base year
3,000 m
Normalized
ROE = 9.4%

Expected
growth in
asset base
4%

Target capital
ratio 10%

Target ROE
10.2%

Stable Growth
g = 3%; Beta = 1.00
Cost of equity = 10.20%
Return on equity = 10.20%;
Reinvestment Rate = g/ROE
= $3/10.20\% = 29.41\%$

Cashflows

| | 1 | 2 | 3 | 4 | 5 |
|--------------------|-----------|-----------|-----------|-----------|-----------|
| Asset Base | 325,398 € | 338,414 € | 351,950 € | 366,028 € | 380,669 € |
| Capital ratio | 10.16% | 10.12% | 10.08% | 10.04% | 10.00% |
| Regulatory Capital | 33,060 € | 34,247 € | 35,477 € | 36,749 € | 38,067 € |
| Change in capital | 1,146 € | 1,187 € | 1,229 € | 1,273 € | 1,318 € |
| ROE | 9.56% | 9.72% | 9.88% | 10.04% | 10.20% |
| Net Income | 3,161 € | 3,329 € | 3,505 € | 3,690 € | 3,883 € |
| -Reinvestment | 1,146 € | 1,187 € | 1,229 € | 1,273 € | 1,318 € |
| FCFE | 2,014 € | 2,142 € | 2,276 € | 2,417 € | 2,565 € |

Terminal Value₅ = $2,823 / (.102 - .03) = 39,209$ m

3,999
1,176
2,823

PV of CF = 31,383 m
/ # shares 581.85
Value/Share 53.94 €

Discount at Cost of equity = $3.60\% + 1.162 * 6\% + -0.60\% = 11.172\%$

In March 2009
Deutsche Bank price = 48
Euros/share (down from 89
Euros in early 2008)

Riskfree Rate:
Euro Riskfree Rate =
3.6%

+

Beta
1.162

X

Mature market
premium
6%

+

| Region | Lambda | CRP |
|----------------------|--------|-------|
| Western Europe | 0.68 | 0.00% |
| United States | 0.42 | 0.00% |
| Latin America | 0.01 | 4.50% |
| Africa & Middle East | 0.01 | 7.00% |
| Asia | 0.11 | 3.50% |
| Eastern Europe | 0.04 | 3.00% |
| Deutsche Bank | | 0.60% |

Beta for commercial &
Investment banking

Aswath Damodaran

V. Valuing cyclical and commodity companies

Company growth often comes from movements in the economic cycle, for cyclical firms, or commodity prices, for commodity companies.

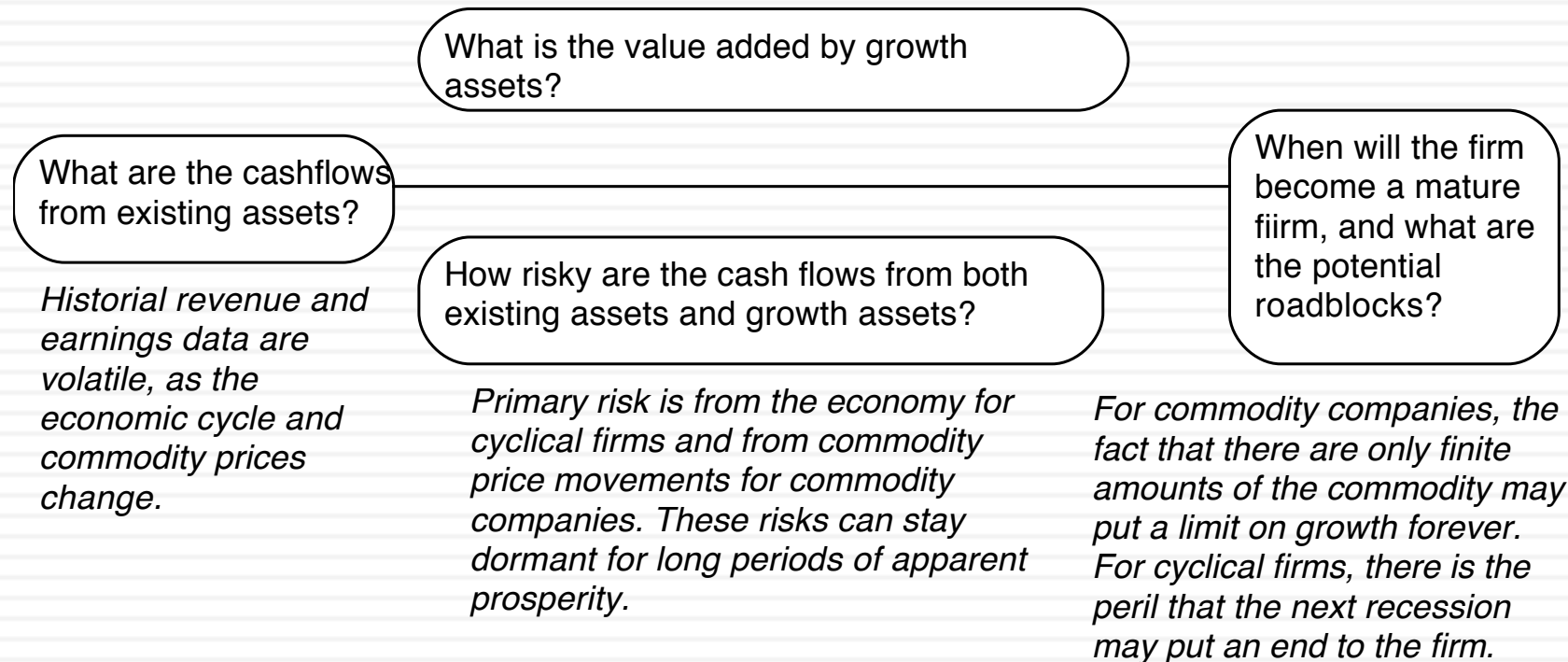

Valuing a Cyclical Company - Toyota in Early 2009

| Year | Revenues | Operating Incol | EBITDA | Operating Marg |
|----------------|-------------|-----------------|------------|----------------|
| FY1 1992 | ¥10,163,380 | ¥218,511 | ¥218,511 | 2.15% |
| FY1 1993 | ¥10,210,750 | ¥181,897 | ¥181,897 | 1.78% |
| FY1 1994 | ¥9,362,732 | ¥136,226 | ¥136,226 | 1.45% |
| FY1 1995 | ¥8,120,975 | ¥255,719 | ¥255,719 | 3.15% |
| FY1 1996 | ¥10,718,740 | ¥348,069 | ¥348,069 | 3.25% |
| FY1 1997 | ¥12,243,830 | ¥665,110 | ¥665,110 | 5.43% |
| FY1 1998 | ¥11,678,400 | ¥779,800 | ¥1,382,950 | 6.68% |
| FY1 1999 | ¥12,749,010 | ¥774,947 | ¥1,415,997 | 6.08% |
| FY1 2000 | ¥12,879,560 | ¥775,982 | ¥1,430,982 | 6.02% |
| FY1 2001 | ¥13,424,420 | ¥870,131 | ¥1,542,631 | 6.48% |
| FY1 2002 | ¥15,106,300 | ¥1,123,475 | ¥1,822,975 | 7.44% |
| FY1 2003 | ¥16,054,290 | ¥1,363,680 | ¥2,101,780 | 8.49% |
| FY1 2004 | ¥17,294,760 | ¥1,666,894 | ¥2,454,994 | 9.64% |
| FY1 2005 | ¥18,551,530 | ¥1,672,187 | ¥2,447,987 | 9.01% |
| FY1 2006 | ¥21,036,910 | ¥1,878,342 | ¥2,769,742 | 8.93% |
| FY1 2007 | ¥23,948,090 | ¥2,238,683 | ¥3,185,683 | 9.35% |
| FY1 2008 | ¥26,289,240 | ¥2,270,375 | ¥3,312,775 | 8.64% |
| FY 2009 (Estin | ¥22,661,325 | ¥267,904 | ¥1,310,304 | 1.18% |
| | | ¥1,306,867 | | 7.33% |

Normalized Earnings ①

As a cyclical company, Toyota's earnings have been volatile and 2009 earnings reflect the troubled global economy. We will assume that when economic growth returns, the operating margin for Toyota will revert back to the historical average.

$$\text{Normalized Operating Income} = \text{Revenues in 2009} * \text{Average Operating Margin (98--09)}$$

$$= 22661 * .0733 = 1660.7 \text{ billion yen}$$

Normalized Return on capital and Reinvestment ②

Once earnings bounce back to normal, we assume that Toyota will be able to earn a return on capital equal to its cost of capital (5.09%). This is a sector, where earning excess returns has proved to be difficult even for the best of firms.

To sustain a 1.5% growth rate, the reinvestment rate has to be:

$$\text{Reinvestment rate} = 1.5\% / 5.09\%$$

$$= 29.46\%$$

| | |
|------------------------|--------|
| Operating Assets | 19,640 |
| + Cash | 2,288 |
| + Non-operating assets | 6,845 |
| - Debt | 11,862 |
| - Minority Interests | 583 |
| Value of Equity | |
| / No of shares | /3,448 |
| Value per share | ¥4735 |

$$\text{Value of operating assets} = \frac{1660.7 (1.015) (1 - .407) (1 - .2946)}{(.0509 - .015)} = 19,640 \text{ billion}$$

Normalized Cost of capital ③

The cost of capital is computed using the average beta of automobile companies (1.10), and Toyota's cost of debt (3.25%) and debt ratio (52.9% debt ratio). We use the Japanese marginal tax rate of 40.7% for computing both the after-tax cost of debt and the after-tax operating income

$$\text{Cost of capital} = 8.65\% (.471) + 3.25\% (1 - .407) (.529) = 5.09\%$$

Aswath Damodaran

Stable Growth ④

Once earnings are normalized, we assume that Toyota, as the largest market-share company, will be able to maintain only stable growth (1.5% in Yen terms)

Shell: A "Oil Price" Neutral Valuation: March 2016

Revenue calculated from prevailing oil price of \$40/barrel in March 2016
 Revenue = $39992.77 + 4039.40 * \$40$
 = \$201,569

Compounded revenue growth of 3.91% a year, based on Shell's historical revenue growth rate from 2000 to 2015

| | Base Year | 1 | 2 | 3 | 4 | 5 | Terminal Year |
|---------------------------|---------------|--------------|--------------|--------------|--------------|---------------|---------------|
| Revenues | \$ 201,569 | \$ 209,450 | \$ 217,639 | \$ 226,149 | \$ 234,991 | \$ 244,180 | \$ 249,063 |
| Operating Margin | 3.01% | 6.18% | 7.76% | 8.56% | 8.95% | 9.35% | 9.35% |
| Operating Income | \$ 6,065.00 | \$ 12,942.85 | \$ 16,899.10 | \$ 19,352.39 | \$ 21,040.39 | \$ 22,830.80 | \$ 23,287.41 |
| Effective tax rate | 30.00% | 30.00% | 30.00% | 30.00% | 30.00% | 30.00% | 30.00% |
| AT Operating Income | \$ 4,245.50 | \$ 9,060.00 | \$ 11,829.37 | \$ 13,546.68 | \$ 14,728.27 | \$ 15,981.56 | \$ 16,301.19 |
| + Depreciation | \$ 26,714.00 | \$ 27,759 | \$ 28,844 | \$ 29,972 | \$ 31,144 | \$ 32,361 | |
| - Cap Ex | \$ 31,854.00 | \$ 33,099 | \$ 34,394 | \$ 35,738 | \$ 37,136 | \$ 38,588 | |
| - Chg in WC | | \$ 472.88 | \$ 491.37 | \$ 510.58 | \$ 530.55 | \$ 551.29 | |
| FCFF | | \$ 3,246.14 | \$ 5,788.19 | \$ 7,269.29 | \$ 8,205.44 | \$ 9,203.68 | \$ 13,011.34 |
| Terminal Value | | | | | | \$ 216,855.71 | |
| Return on capital | | | | | | | 12.37% |
| Cost of Capital | | 9.91% | 9.91% | 9.91% | 9.91% | 9.91% | 8.00% |
| Cumulated Discount Factor | | 1.0991 | 1.2080 | 1.3277 | 1.4593 | 1.6039 | |
| Present Value | | \$ 2,953.45 | \$ 4,791.47 | \$ 5,474.95 | \$ 5,622.81 | \$ 140,940.73 | |
| Value of Operating Assets | \$ 159,783.41 | | | | | | |
| + Cash | \$ 31,752.00 | | | | | | |
| + Cross Holdings | \$ 33,566.00 | | | | | | |
| - Debt | \$ 58,379.00 | | | | | | |
| - Minority Interests | \$ 1,245.00 | | | | | | |
| Value of Equity | \$ 165,477.41 | | | | | | |
| Number of shares | 4209.7 | | | | | | |
| Value per share | \$ 39.31 | | | | | | |

Operating margin converges on Shell's historical average margin of 9.35% from 200-2015

Return on capital reverts and stays at Shell's historic average of 12.37% from 200-2015

Added long term investments in joint ventures and subtracted out minority interest in consolidated holdings.

Shell's Revenues & Oil Prices

Shell: Revenues vs Oil Price

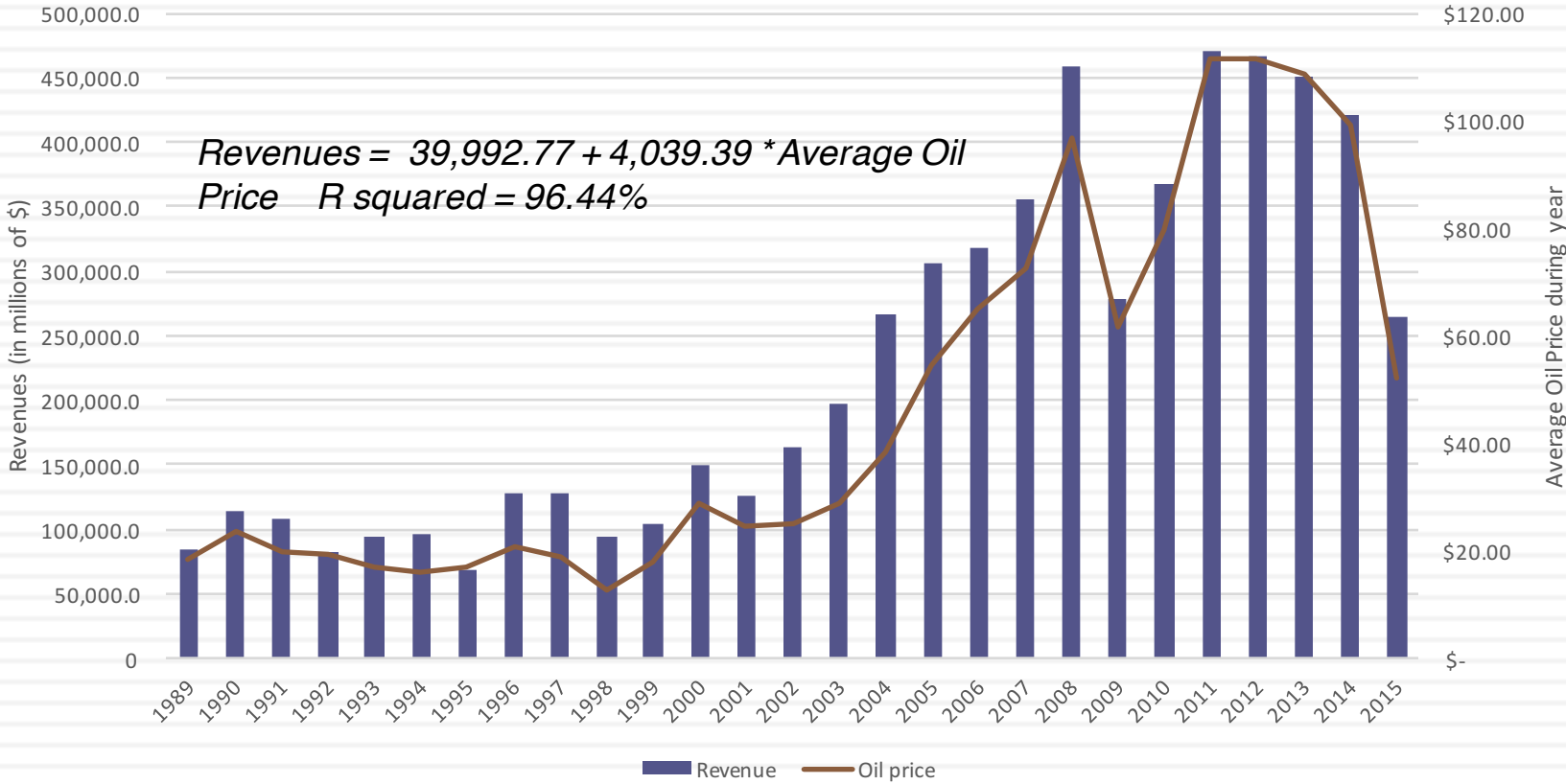

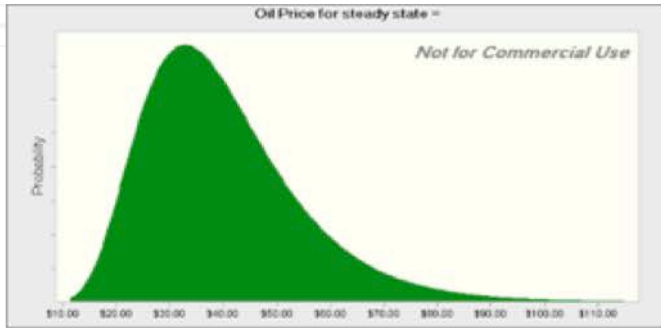

Revenue calculated from the oil price drawn from distribution
 $Revenue = 39992.77 + 4039.40 * Oil\ Price/Barrel$

Pre-tax Operating Income based on revenue & selected margin
 $Pre-tax\ Operating\ Income = Revenues * Operating\ Margin$



Value Shell based on operating income, assuming other assumptions (tax rate, revenue growth, cost of capital)

| Percentiles: | Forecast values |
|--------------|-----------------|
| 0% | \$6.55 |
| 10% | \$23.90 |
| 20% | \$27.73 |
| 30% | \$30.89 |
| 40% | \$33.88 |
| 50% | \$36.99 |
| 60% | \$40.28 |
| 70% | \$44.22 |
| 80% | \$49.24 |
| 90% | \$57.49 |
| 100% | \$197.11 |

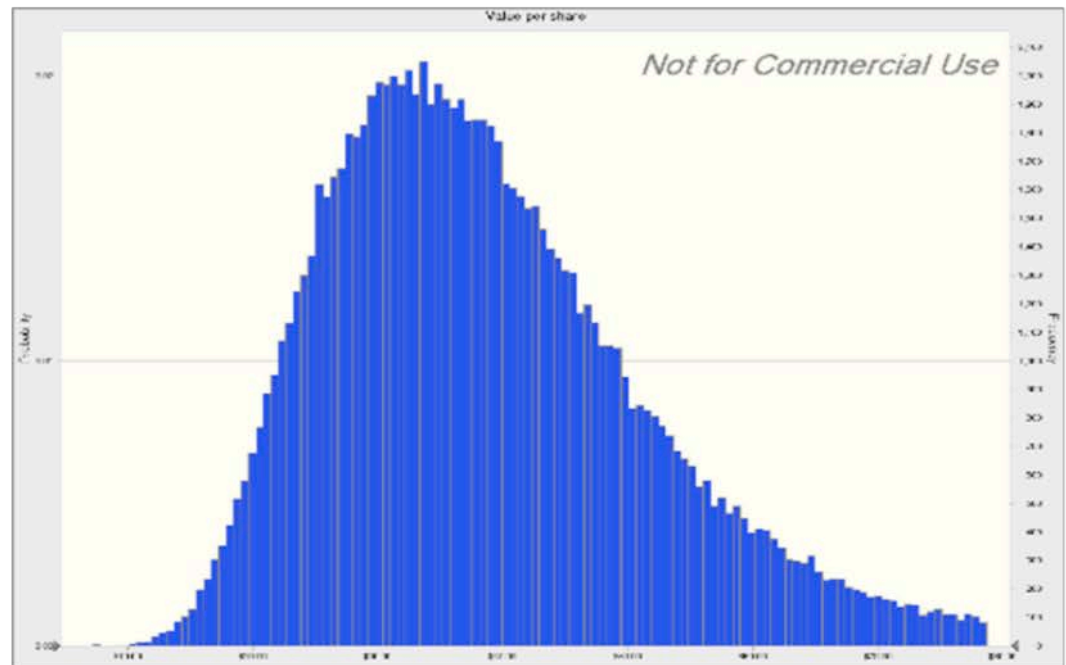

Lesson 1: With “macro” companies, it is easy to get lost in “macro” assumptions...

- With cyclical and commodity companies, it is undeniable that the value you arrive at will be affected by your views on the economy or the price of the commodity.
- Consequently, you will feel the urge to take a stand on these macro variables and build them into your valuation. Doing so, though, will create valuations that are jointly impacted by your views on macro variables and your views on the company, and it is difficult to separate the two.
- The best (though not easiest) thing to do is to separate your macro views from your micro views. Use current market based numbers for your valuation, but then provide a separate assessment of what you think about those market numbers.

Lesson 2: Use probabilistic tools to assess value as a function of macro variables...

- If there is a key macro variable affecting the value of your company that you are uncertain about (and who is not), why not quantify the uncertainty in a distribution (rather than a single price) and use that distribution in your valuation.
- That is exactly what you do in a Monte Carlo simulation, where you allow one or more variables to be distributions and compute a distribution of values for the company.
- With a simulation, you get not only everything you would get in a standard valuation (an estimated value for your company) but you will get additional output (on the variation in that value and the likelihood that your firm is under or over valued)

The optionality in commodities: Undeveloped reserves as an option

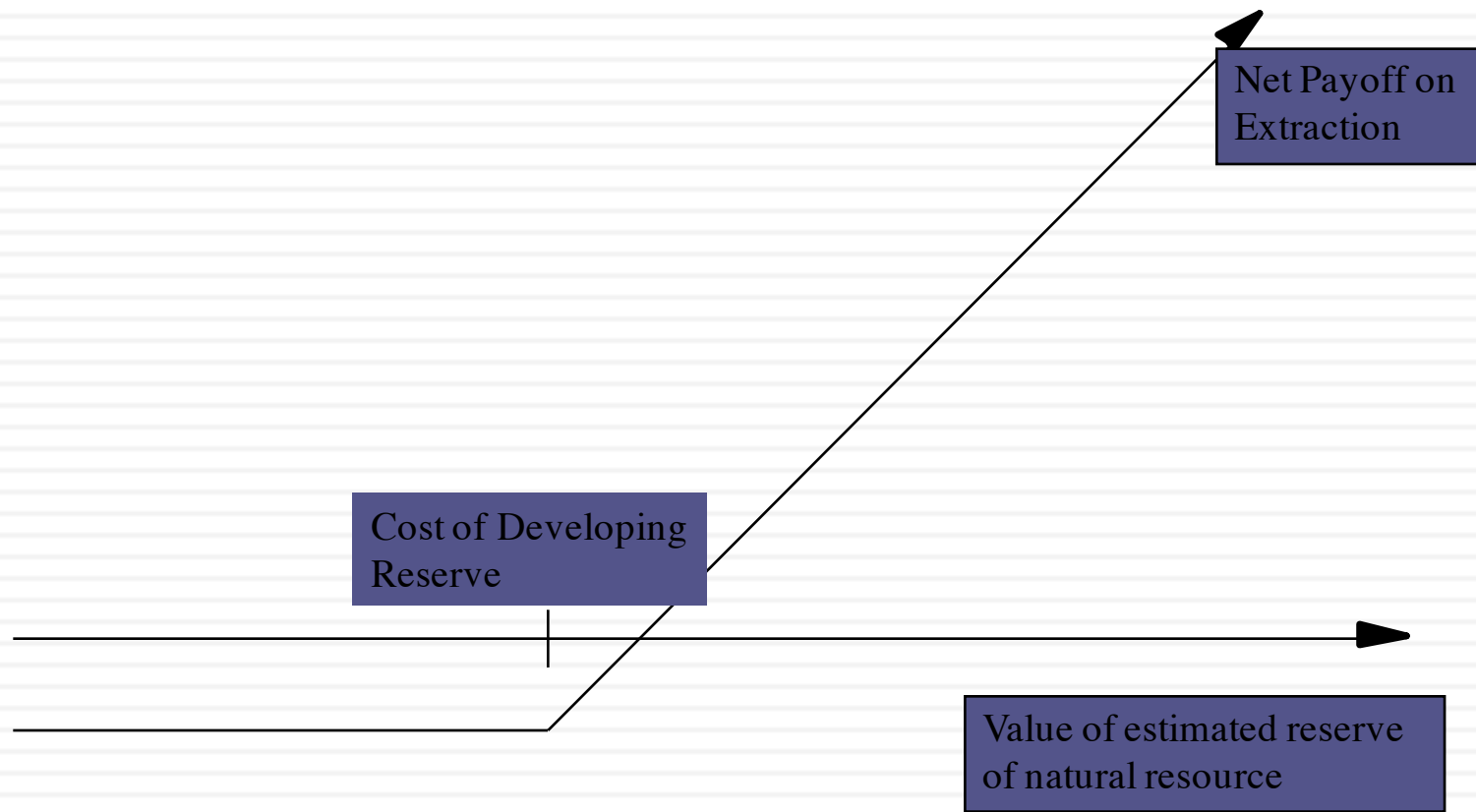

Valuing Gulf Oil

- Gulf Oil was the target of a takeover in early 1984 at \$70 per share (It had 165.30 million shares outstanding, and total debt of \$9.9 billion).
 - It had estimated reserves of 3038 million barrels of oil and the average cost of developing these reserves was estimated to be \$10 a barrel in present value dollars (The development lag is approximately two years).
 - The average relinquishment life of the reserves is 12 years.
 - The price of oil was \$22.38 per barrel, and the production cost, taxes and royalties were estimated at \$7 per barrel.
 - The bond rate at the time of the analysis was 9.00%.
 - Gulf was expected to have net production revenues each year of approximately 5% of the value of the developed reserves. The variance in oil prices is 0.03.

Valuing Undeveloped Reserves

- Inputs for valuing undeveloped reserves
 - Value of underlying asset = Value of estimated reserves discounted back for period of development lag = $3038 * (\$ 22.38 - \$7) / 1.05^2 = \$42,380.44$
 - Exercise price = Estimated development cost of reserves = $3038 * \$10 = \$30,380$ million
 - Time to expiration = Average length of relinquishment option = 12 years
 - Variance in value of asset = Variance in oil prices = 0.03
 - Riskless interest rate = 9%
 - Dividend yield = Net production revenue/ Value of developed reserves = 5%
- Based upon these inputs, the Black-Scholes model provides the following value for the call:
 - $d1 = 1.6548$ $N(d1) = 0.9510$
 - $d2 = 1.0548$ $N(d2) = 0.8542$
- Call Value = $42,380.44 \exp^{(-0.05)(12)} (0.9510) - 30,380 (\exp^{(-0.09)(12)} (0.8542)) = \$13,306$ million

The composite value...

- In addition, Gulf Oil had free cashflows to the firm from its oil and gas production of \$915 million from already developed reserves and these cashflows are likely to continue for ten years (the remaining lifetime of developed reserves).
- The present value of these developed reserves, discounted at the weighted average cost of capital of 12.5%, yields:
 - Value of already developed reserves = $915 (1 - 1.125^{-10}) / .125 = \5065.83
- Adding the value of the developed and undeveloped reserves
 - Value of undeveloped reserves = \$ 13,306 million
 - Value of production in place = \$ 5,066 million
 - Total value of firm = \$ 18,372 million
 - Less Outstanding Debt = \$ 9,900 million
 - Value of Equity = \$ 8,472 million
 - Value per share = \$ 8,472 / 165.3 = \$51.25

VII. Valuing Companies across the ownership cycle

Reported income and balance sheet are heavily affected by tax considerations rather than information disclosure requirements. The line between the personal and business expenses is a fine one.

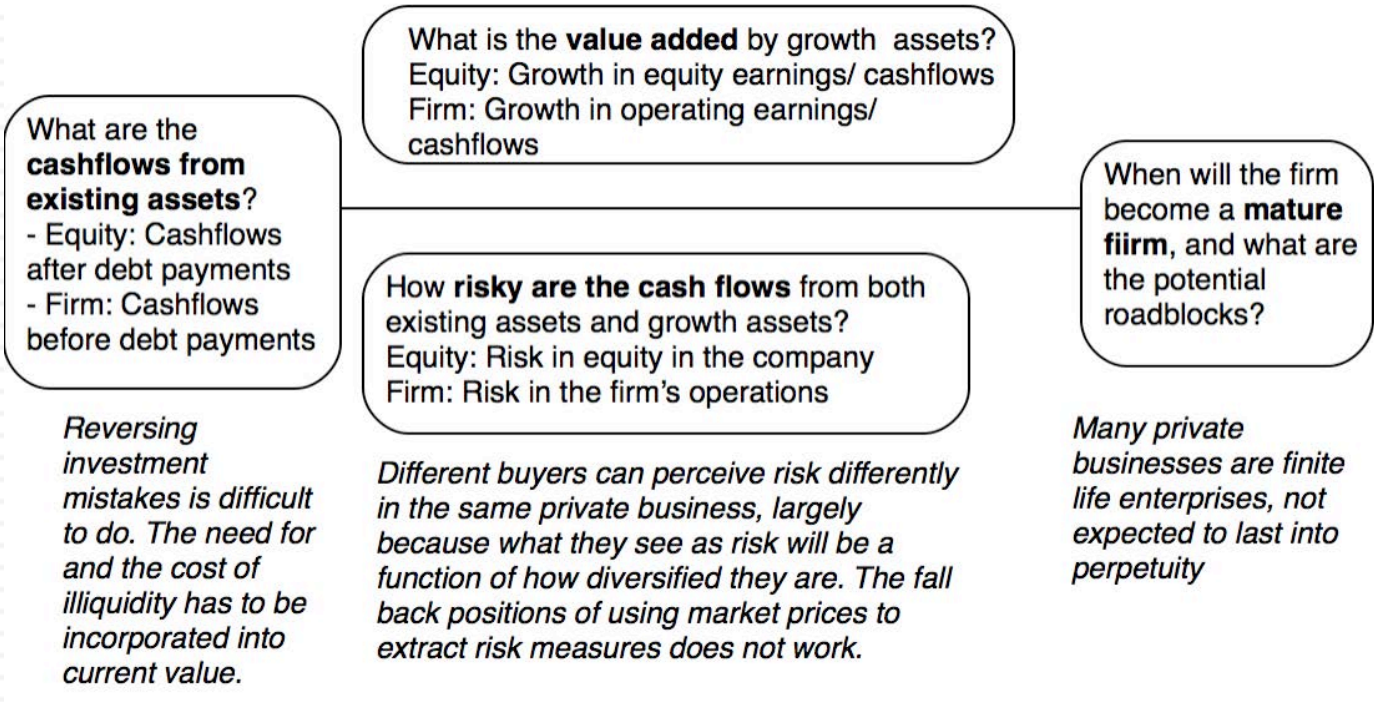

Reversing investment mistakes is difficult to do. The need for and the cost of illiquidity has to be incorporated into current value.

Different buyers can perceive risk differently in the same private business, largely because what they see as risk will be a function of how diversified they are. The fall back positions of using market prices to extract risk measures does not work.

Many private businesses are finite life enterprises, not expected to last into perpetuity

Kristin's Kandy: Valuation in March 2006

Current Cashflow to Firm
 EBIT(1-t) : 300
 - Nt CpX 100
 - Chg WC 40
 = FCFF 160
 Reinvestment Rate = 46.67%

Reinvestment Rate
 46.67%

Expected Growth in EBIT (1-t)
 $.4667 * .1364 = .0636$
6.36%

Return on Capital
 13.64%

Stable Growth
 $g = 4\%$; $\text{Beta} = 3.00$;
 $\text{ROC} = 12.54\%$
 Reinvestment Rate = 31.90%

Terminal Value $_5 = 289 / (.1254 - .04) = 3,403$

Firm Value: 2,571
 + Cash 125
 - Debt: 900
 = Equity 1,796
 - Illiq Discount 12.5%
 Adj Value 1,571

| Year | 1 | 2 | 3 | 4 | 5 | Term Yr |
|----------------|-------|-------|-------|-------|-------|---------|
| EBIT (1-t) | \$319 | \$339 | \$361 | \$384 | \$408 | 425 |
| - Reinvestment | \$149 | \$158 | \$168 | \$179 | \$191 | 136 |
| =FCFF | \$170 | \$181 | \$193 | \$205 | \$218 | 289 |

Discount at Cost of Capital (WACC) = 16.26% (.70) + 3.30% (.30) = 12.37%

Cost of Equity
 16.26%

Cost of Debt
 $(4.5\% + 1.00)(1 - .40) = 3.30\%$
 Synthetic rating = A-

Weights
 E = 70% D = 30%

Riskfree Rate:
 Riskfree rate = 4.50%
 (10-year T.Bond rate)

Total Beta
 2.94

Risk Premium
 4.00%

1/3 of risk is market risk

Adjusted for owner non-diversification

Market Beta: 0.98

Mature risk premium 4%

Country Risk Premium 0%

Aswath Damodaran

Unlevered Beta for Sectors: 0.78

Firm's D/E Ratio: 30/70

Lesson 1: In private businesses, risk in the eyes of the “beholder” (buyer)

Private business owner with entire wealth invested in the business

Venture capitalist, with multiple holdings in the sector.

Public company investor with diversified portfolio

Exposed to all risk in the company. Total beta measures exposure to total risk. Total Beta = Market Beta/ Correlation of firm with market

Partially diversified. Diversify away some firm specific risk but not all. Beta will fall between total and market beta.

Firm-specific risk is diversified away. Market or macro risk exposure captured in a market beta or betas.

Private Owner versus Publicly Traded Company Perceptions of Risk in an Investment

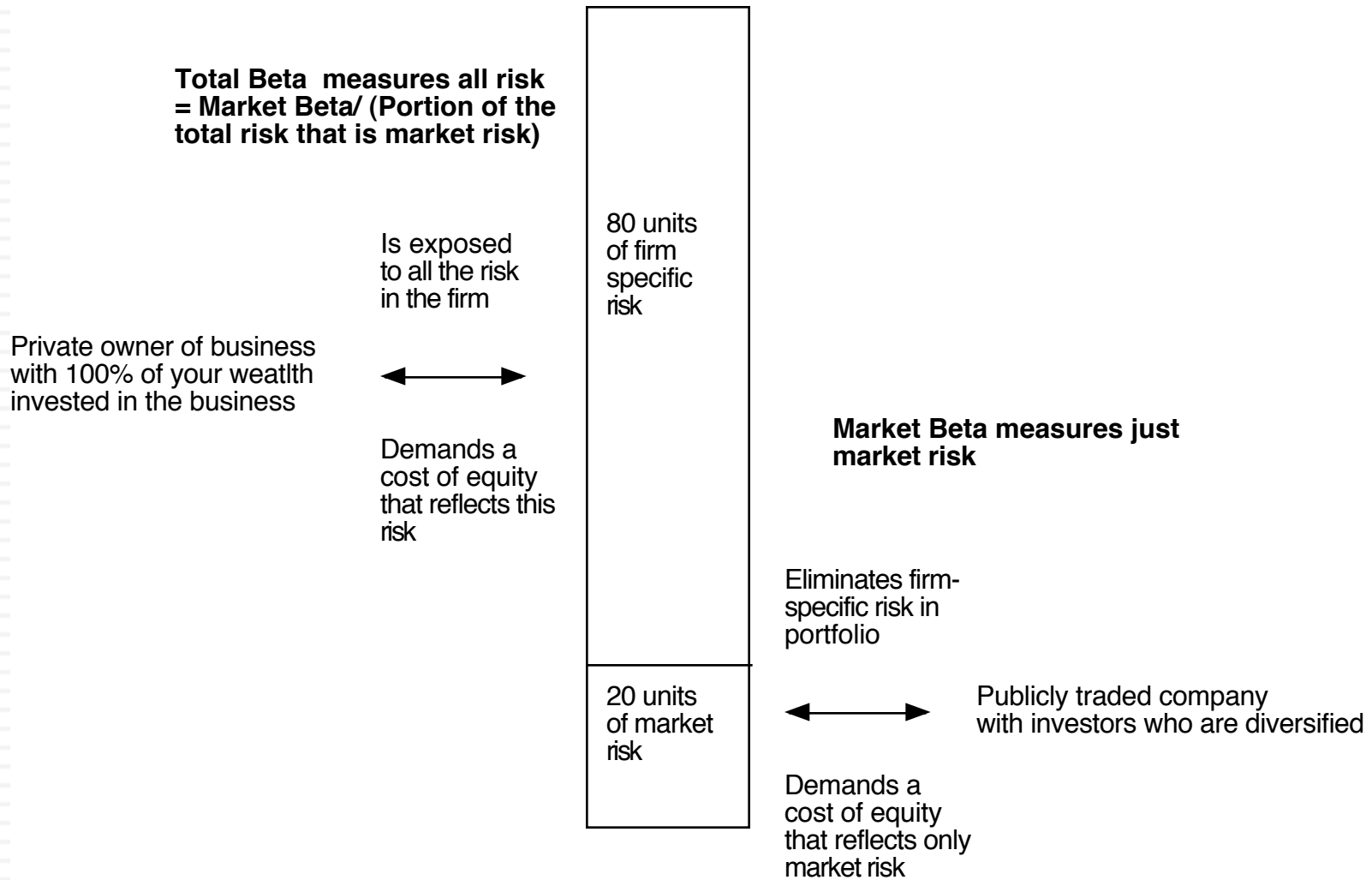

Total Risk versus Market Risk

- Adjust the beta to reflect total risk rather than market risk. This adjustment is a relatively simple one, since the R squared of the regression measures the proportion of the risk that is market risk.
 - ▣ Total Beta = Market Beta / Correlation of the sector with the market
- To estimate the beta for Kristin Kandy, we begin with the bottom-up unlevered beta of food processing companies:
 - ▣ Unlevered beta for publicly traded food processing companies = 0.78
 - ▣ Average correlation of food processing companies with market = 0.333
 - ▣ Unlevered total beta for Kristin Kandy = $0.78/0.333 = 2.34$
 - ▣ Debt to equity ratio for Kristin Kandy = $0.3/0.7$ (assumed industry average)
 - ▣ Total Beta = $2.34 (1 - (1-.40)(30/70)) = 2.94$
 - ▣ Total Cost of Equity = $4.50\% + 2.94 (4\%) = 16.26\%$

Lesson 2: With financials, trust but verify..

- Different Accounting Standards: The accounting statements for private firms are often based upon different accounting standards than public firms, which operate under much tighter constraints on what to report and when to report.
- Intermingling of personal and business expenses: In the case of private firms, some personal expenses may be reported as business expenses.
- Separating “Salaries” from “Dividends”: It is difficult to tell where salaries end and dividends begin in a private firm, since they both end up with the owner.
- The Key Person issue: In some private businesses, with a personal component, the cashflows may be intertwined with the owner being part of the business.

Lesson 3: Illiquidity is a clear and present danger..

- In private company valuation, illiquidity is a constant theme. All the talk, though, seems to lead to a rule of thumb. The illiquidity discount for a private firm is between 20-30% and does not vary across private firms.
- But illiquidity should vary across:
 - Companies: Healthier and larger companies, with more liquid assets, should have smaller discounts than money-losing smaller businesses with more illiquid assets.
 - Time: Liquidity is worth more when the economy is doing badly and credit is tough to come by than when markets are booming.
 - Buyers: Liquidity is worth more to buyers who have shorter time horizons and greater cash needs than for longer term investors who don't need the cash and are willing to hold the investment.

And it is not just in private businesses..

- Almarai is a publicly traded company with 600 million shares outstanding but only 175 million of these shares are traded (float). One reason is that Almarai, like most Middle Eastern companies, is controlled by family holdings (Savola Group and Al Saud Sultan Mohamed).
- In addition, the Saudi market is not a very liquid market, with little trading volume and not much non-Saudi investor interests in Saudi stocks.
- Will the lack of liquidity affect your valuation of Almarai?
 - a. Yes
 - b. No



NARRATIVE AND NUMBERS:
VALUATION AS A BRIDGE



Valuation as a bridge

Number Crunchers

Favored Tools

- Accounting statements
- Excel spreadsheets
- Statistical Measures
- Pricing Data

The Numbers People

Illusions/Delusions

1. Precision: Data is precise
2. Objectivity: Data has no bias
3. Control: Data can control reality

A Good Valuation

Story Tellers

Favored Tools

- Anecdotes
- Experience (own or others)
- Behavioral evidence

The Narrative People

Illusions/Delusions

1. Creativity cannot be quantified
2. If the story is good, the investment will be.
3. Experience is the best teacher

Step 1: Survey the landscape



- Every valuation starts with a narrative, a story that you see unfolding for your company in the future.
- In developing this narrative, you will be making assessments of
 - Your company (its products, its management and its history).
 - The market or markets that you see it growing in.
 - The competition it faces and will face.
 - The macro environment in which it operates.

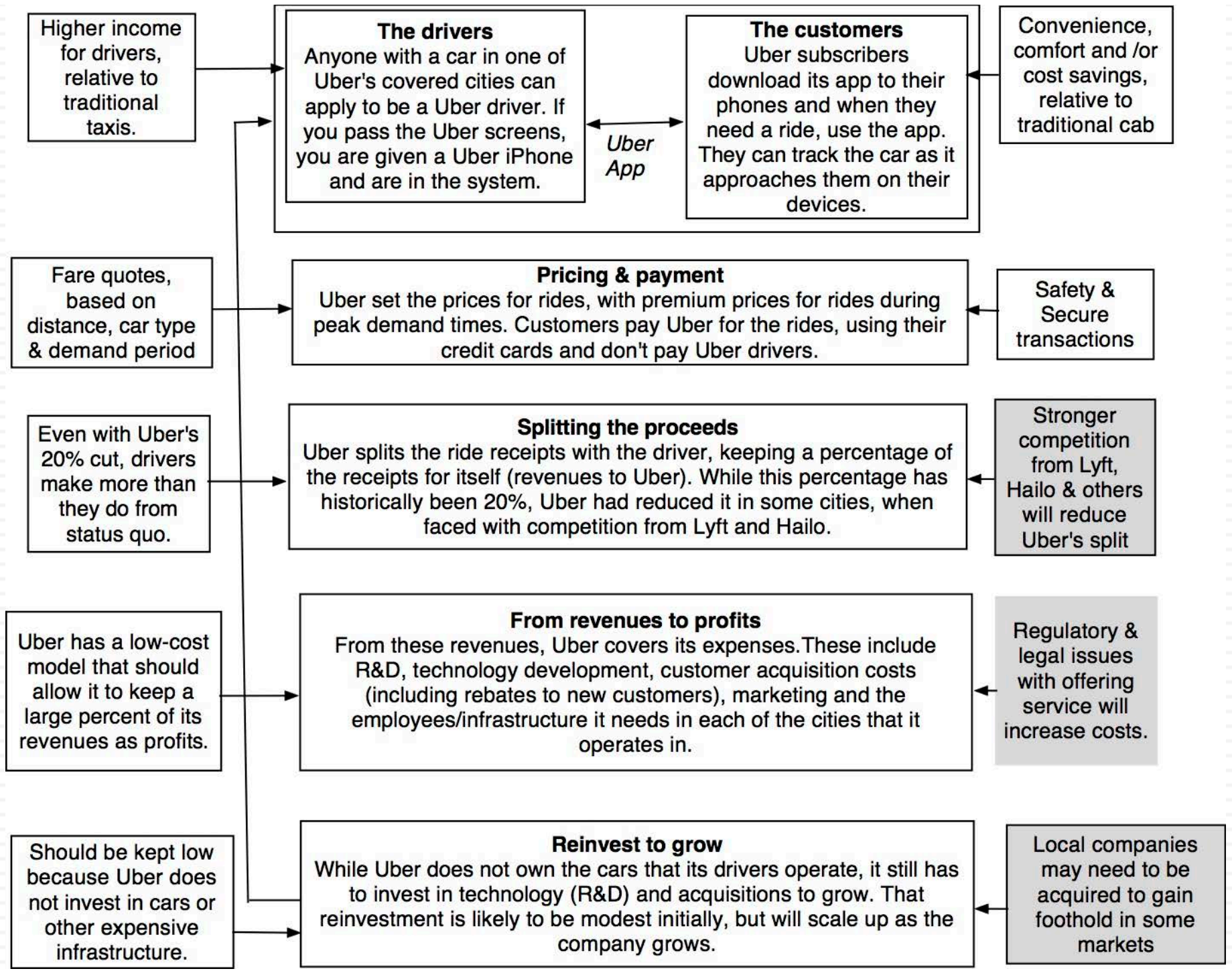

Low Growth

| Year | Revenues (\$) | % Growth Rate |
|-------------------------|---------------|---------------|
| 2005 | 1,274,716.60 | |
| 2006 | 1,421,804.20 | 11.54% |
| 2007 | 1,854,576.40 | 30.44% |
| 2008 | 1,818,533.00 | -1.94% |
| 2009 | 1,572,890.10 | -13.51% |
| 2010 | 1,816,269.40 | 15.47% |
| 2011 | 1,962,630.40 | 8.06% |
| 2012 | 2,110,572.20 | 7.54% |
| 2013 | 2,158,603.00 | 2.28% |
| 2014 | 2,086,124.80 | -3.36% |
| ounded Average = | | 5.63% |

The Auto Business

Low Margins

The Automobile Business: Pre-tax Operating Margins in 2015

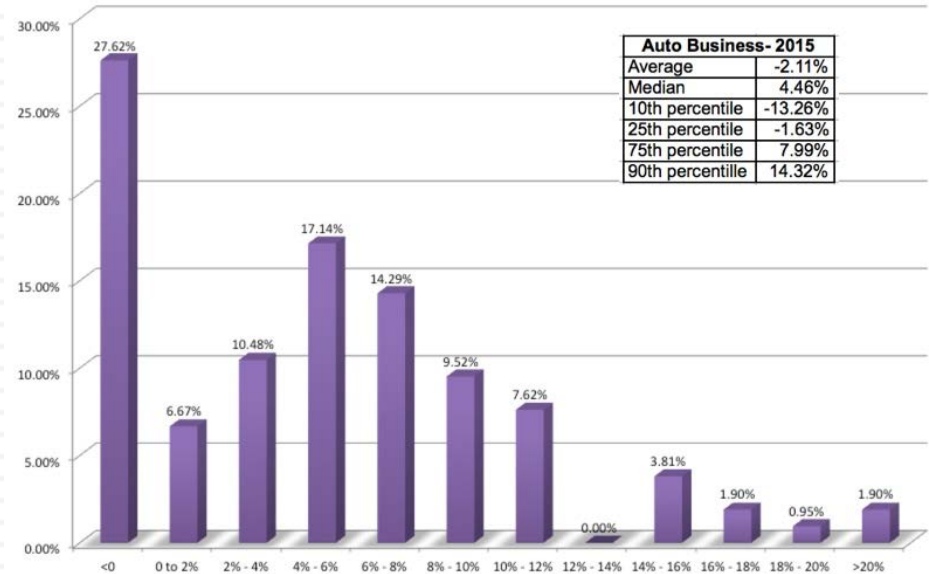

| Auto Business- 2015 | |
|---------------------|---------|
| Average | -2.11% |
| Median | 4.46% |
| 10th percentile | -13.26% |
| 25th percentile | -1.63% |
| 75th percentile | 7.99% |
| 90th percentile | 14.32% |

+

High & Increasing Reinvestment

The Reinvestment Burden: Investment as % of Sales for Auto Business

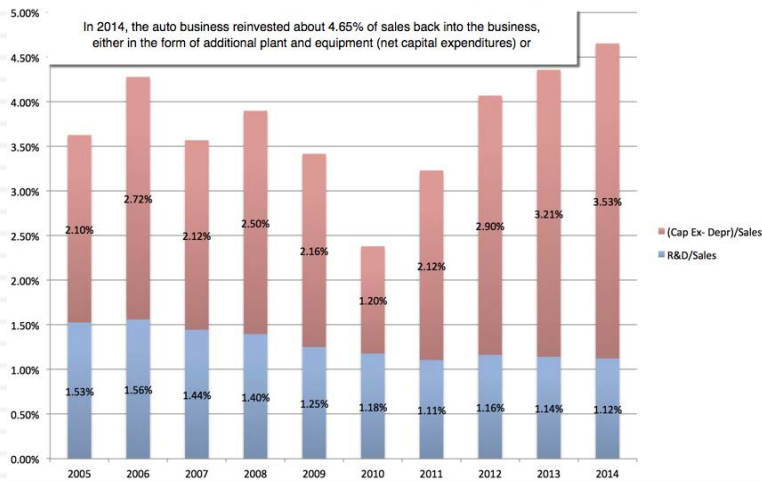

Bad Business

| | ROIC | Cost of capital | ROiC - Cost of capital |
|------|--------|-----------------|------------------------|
| 2004 | 6.82% | 7.93% | -1.11% |
| 2005 | 10.47% | 7.02% | 3.45% |
| 2006 | 4.60% | 7.97% | -3.37% |
| 2007 | 7.62% | 8.50% | -0.88% |
| 2008 | 3.48% | 8.03% | -4.55% |
| 2009 | -4.97% | 8.58% | -13.55% |
| 2010 | 5.16% | 8.03% | -2.87% |
| 2011 | 7.55% | 8.15% | -0.60% |
| 2012 | 7.80% | 8.55% | -0.75% |
| 2013 | 7.83% | 8.47% | -0.64% |
| 2014 | 6.47% | 7.53% | -1.06% |

=

Only once in the last 10 years have auto companies collectively earned more than their cost of capital

What makes Ferrari different?

Ferrari sold only 7,255 cars in all of 2014

Ferrari had a profit margin of 18.2%, in the 95th percentile, partly because of its high prices and partly because it spends little on advertising.

Ferrari: Geographical Sales (2014)

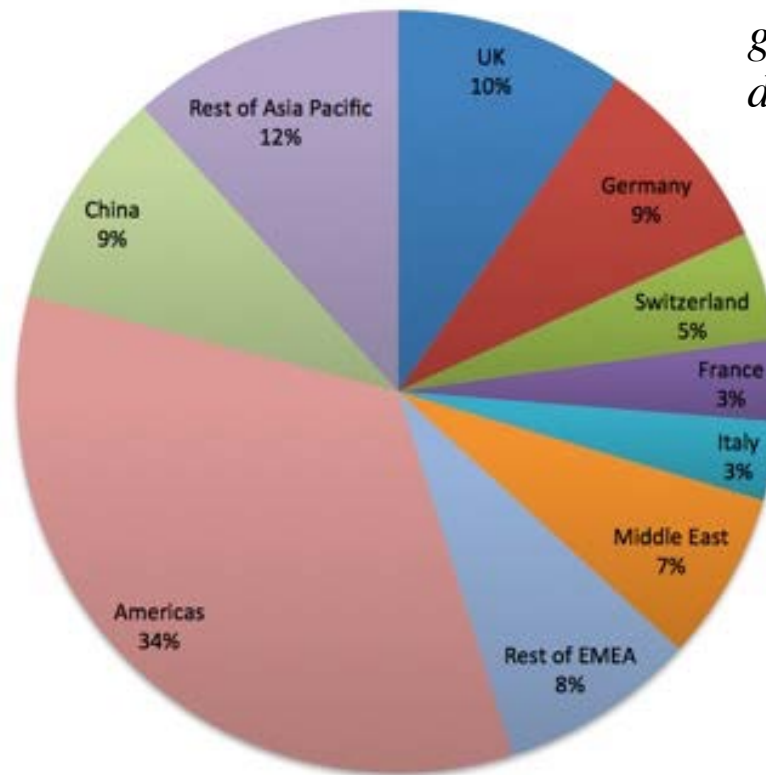

Ferrari sales (in units) have grown very little in the last decade & have been stable

Ferrari has not invested in new plants.

Step 2: Create a narrative for the future

- Every valuation starts with a narrative, a story that you see unfolding for your company in the future.
- In developing this narrative, you will be making assessments of your company (its products, its management), the market or markets that you see it growing in, the competition it faces and will face and the macro environment in which it operates.
 - Rule 1: Keep it simple.
 - Rule 2: Keep it focused.

The Uber Narrative

In June 2014, my initial narrative for Uber was that it would be

1. An urban car service business: I saw Uber primarily as a force in urban areas and only in the car service business.
2. Which would expand the business moderately (about 40% over ten years) by bringing in new users.
3. With local networking benefits: If Uber becomes large enough in any city, it will quickly become larger, but that will be of little help when it enters a new city.
4. Maintain its revenue sharing (20%) system due to strong competitive advantages (from being a first mover).
5. And its existing low-capital business model, with drivers as contractors and very little investment in infrastructure.

The Ferrari Narrative

- Ferrari will stay an exclusive auto club, deriving its allure from its scarcity and the fact that only a few own Ferraris.
- By staying exclusive, the company gets three benefits:
 - It can continue to charge nose bleed prices for its cars and sell them with little or no advertising.
 - It does not need to invest in new assembly plants, since it does not plan to ramp up production.
 - It sells only to the super rich, who are unaffected by overall economic conditions or market crises.

Step 3: Check the narrative against history, economic first principles & common sense

141

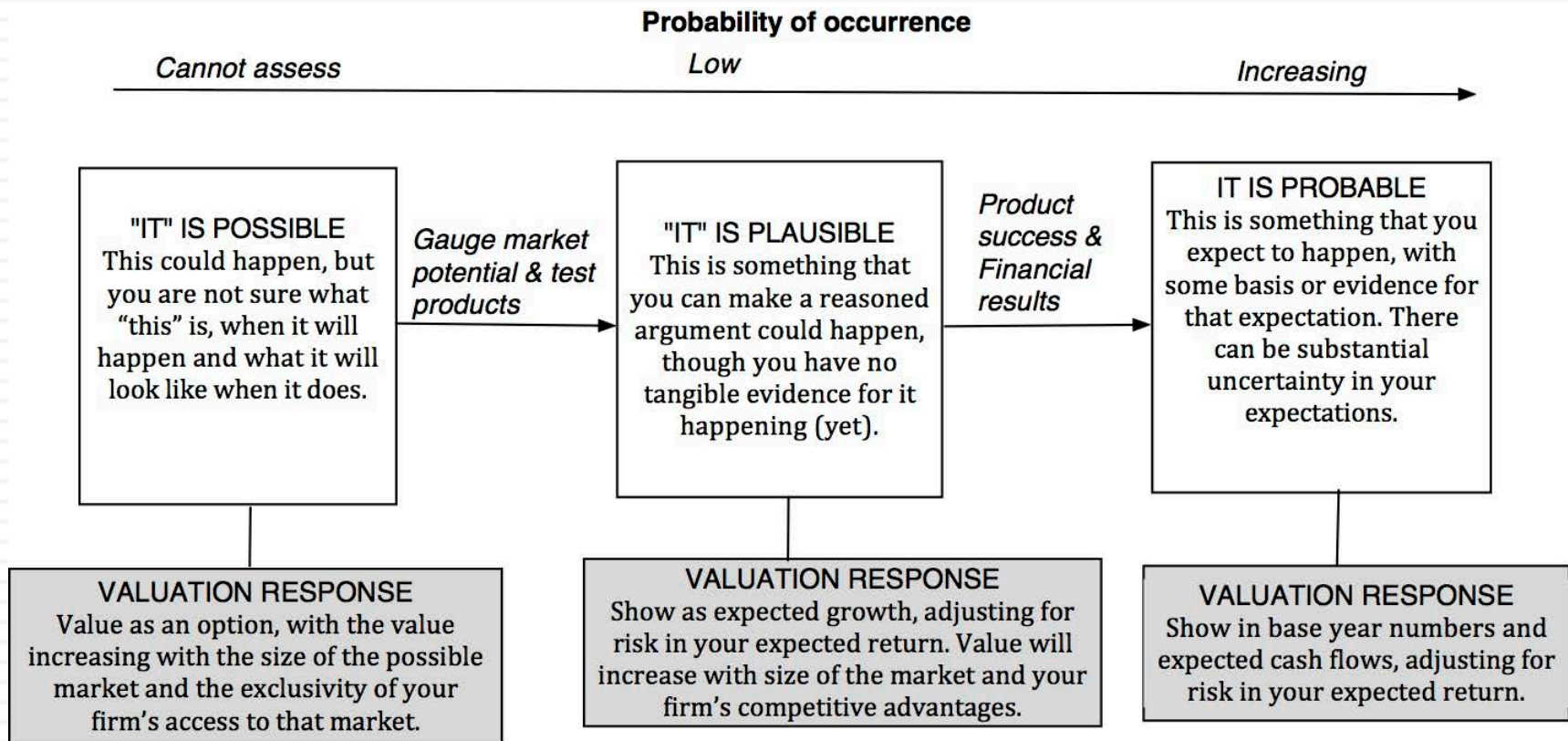

The Impossible, The Implausible and the Improbable

The Impossible

Bigger than the economy
Assuming Growth rate for company in perpetuity > Growth rate for economy

Bigger than the total market
Allowing a company's revenues to grow so much that it has more than a 100% market share of whatever business it is in.

Profit margin > 100%
Assuming earnings growth will exceed revenue growth for a long enough period, and pushing margins above 100%

Depreciation without cap ex
Assuming that depreciation will exceed cap ex in perpetuity.

The Implausible

Growth without reinvestment
Assuming growth forever without reinvestment.

Profits without competition
Assuming that your company will grow and earn higher profits, with no competition.

Returns without risk
Assuming that you can generate high returns in a business with no risk.

The Improbable

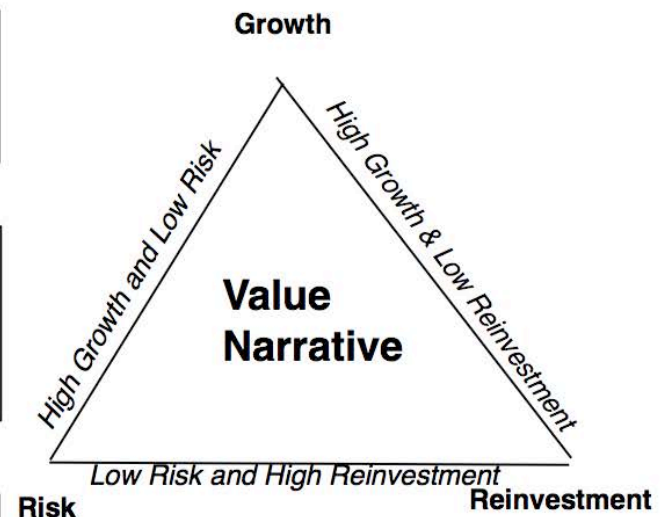

Uber: Possible, Plausible and Probable

Uber (My narrative))

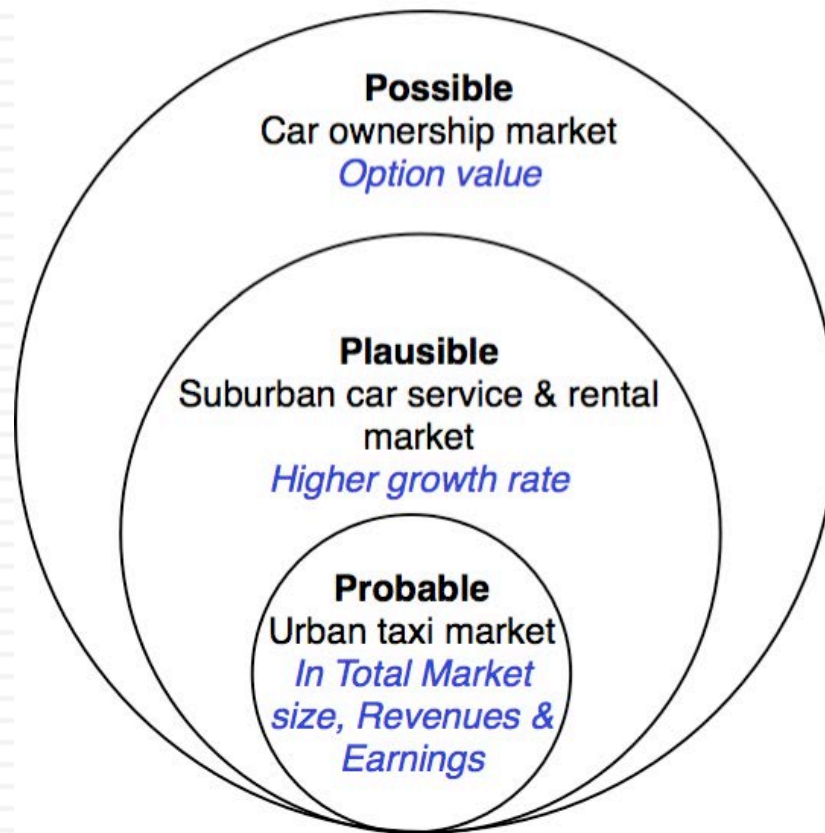

Step 4: Connect your narrative to key drivers of value

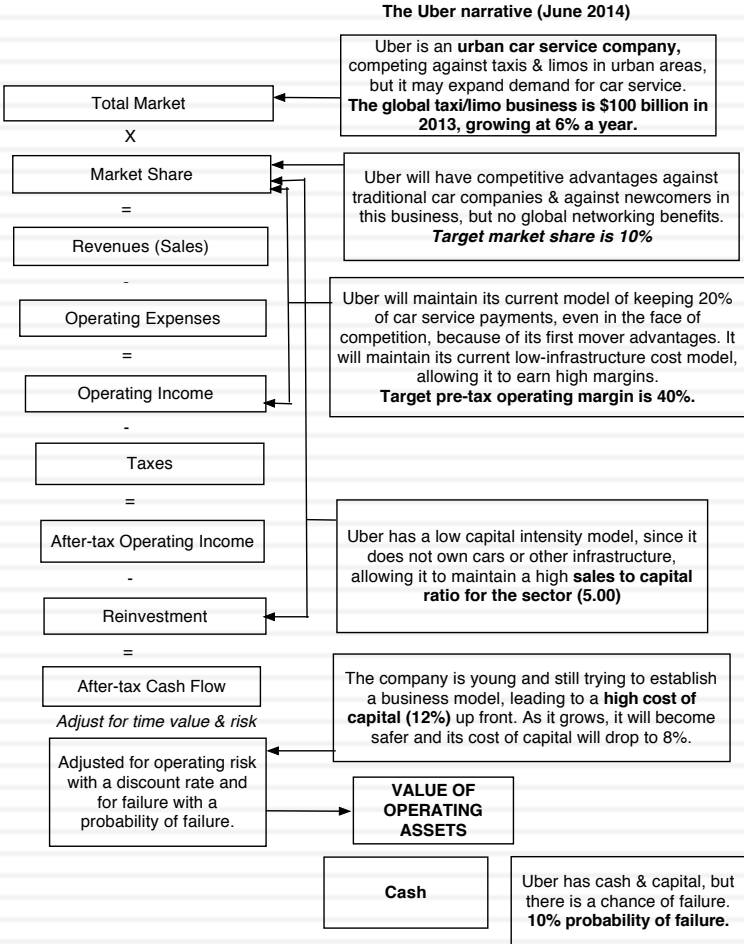

Ferrari: From story to numbers

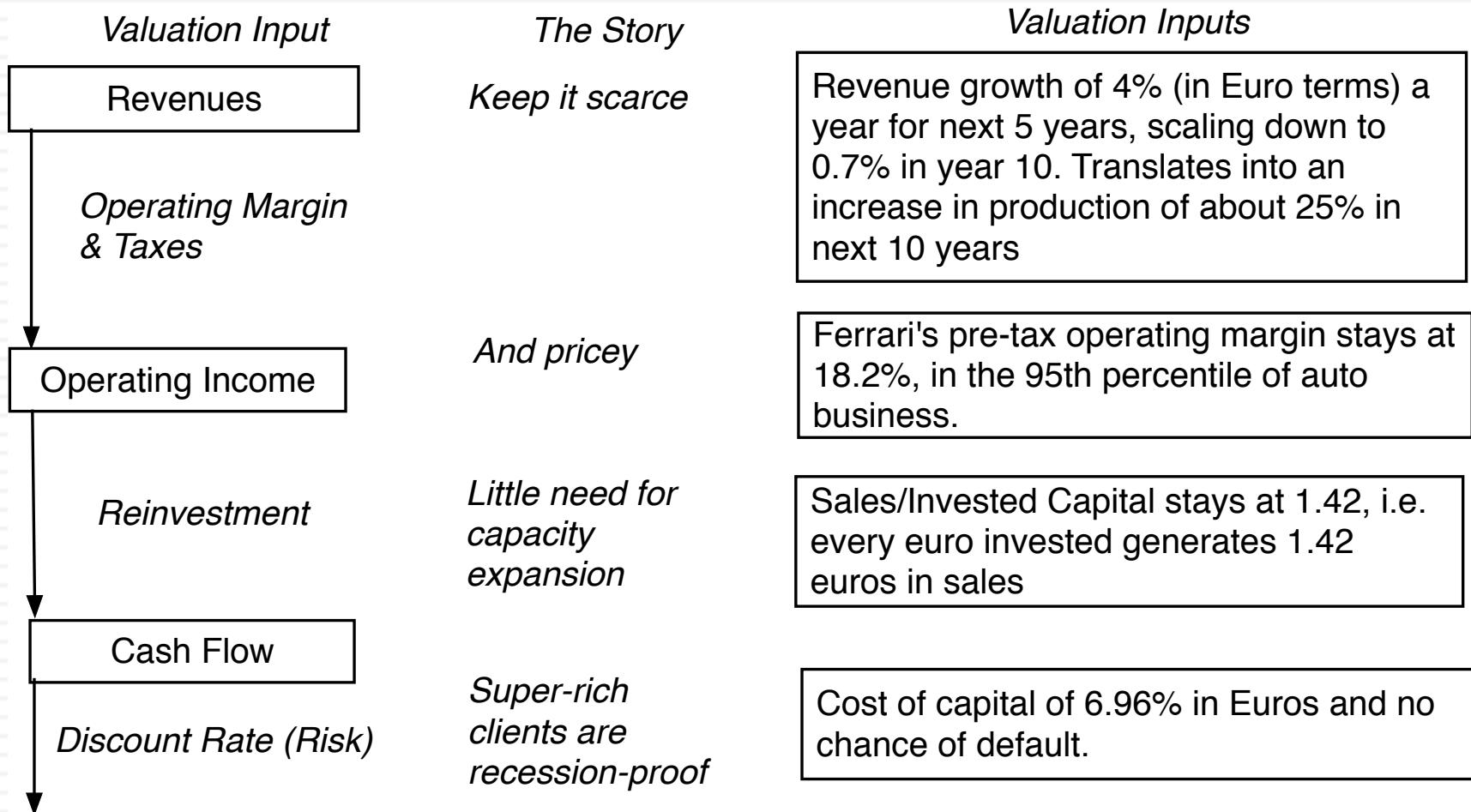

Step 5: Value the company (Uber)

Uber: Intrinsic valuation - June 8, 2014 (in US \$)

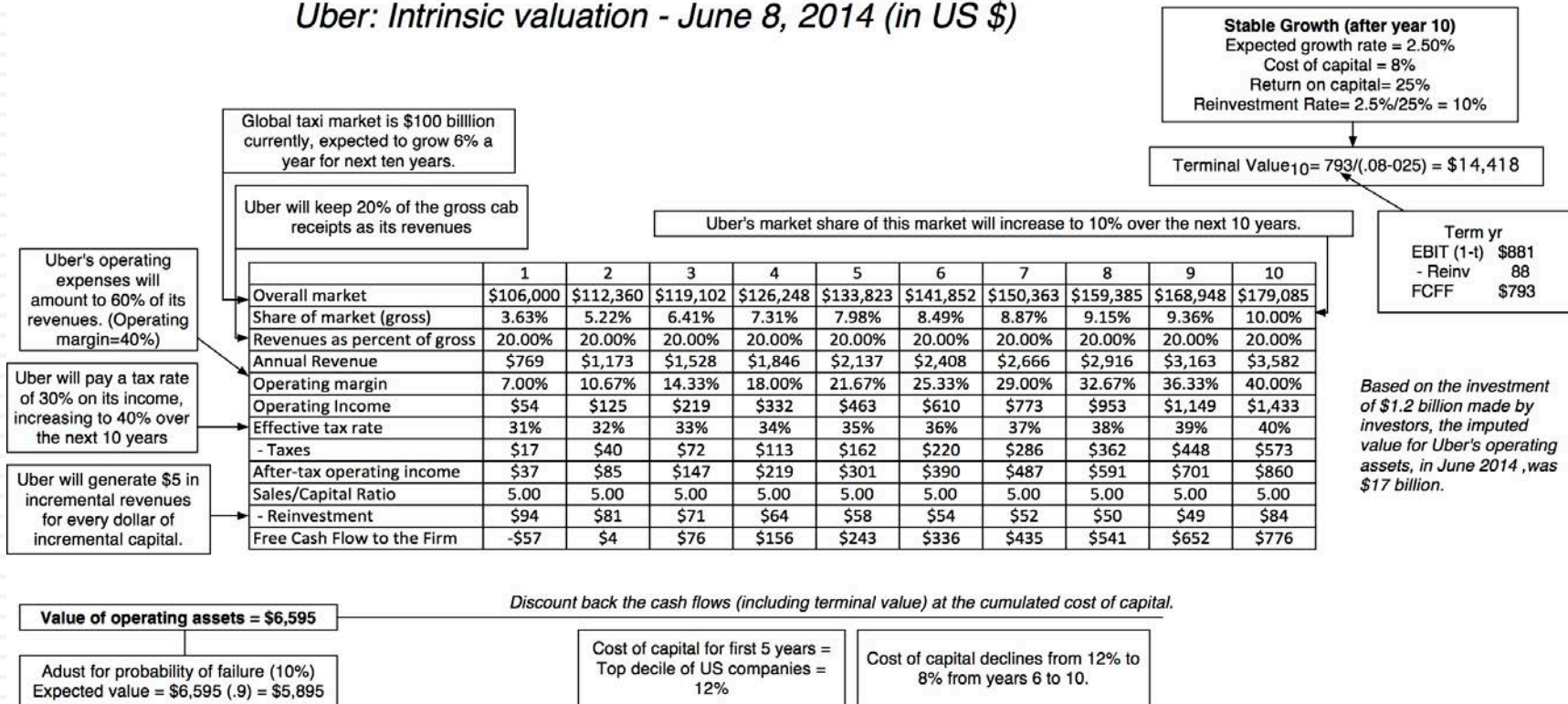

Ferrari: The “Exclusive Club” Value

Stay Super Exclusive: Revenue growth is low

| | Base year | 1 | 2 | 3 | 4 | 5 | 6 | 7 | 8 | 9 | 10 | Terminal year |
|-----------------------------|-----------|---------|---------|---------|---------|---------|---------|---------|---------|---------|---------|---------------|
| Revenue growth rate | | 4.00% | 4.00% | 4.00% | 4.00% | 4.00% | 3.34% | 2.68% | 2.02% | 1.36% | 0.70% | 0.70% |
| Revenues | € 2,763 | € 2,874 | € 2,988 | € 3,108 | € 3,232 | € 3,362 | € 3,474 | € 3,567 | € 3,639 | € 3,689 | € 3,714 | € 3,740 |
| EBIT (Operating) margin | 18.20% | 18.20% | 18.20% | 18.20% | 18.20% | 18.20% | 18.20% | 18.20% | 18.20% | 18.20% | 18.20% | 18.20% |
| EBIT (Operating income) | € 503 | € 523 | € 544 | € 566 | € 588 | € 612 | € 632 | € 649 | € 662 | € 671 | € 676 | € 681 |
| Tax rate | 33.54% | 33.54% | 33.54% | 33.54% | 33.54% | 33.54% | 33.54% | 33.54% | 33.54% | 33.54% | 33.54% | 33.54% |
| EBIT(1-t) | € 334 | € 348 | € 361 | € 376 | € 391 | € 407 | € 420 | € 431 | € 440 | € 446 | € 449 | € 452 |
| - Reinvestment | | € 78 | € 81 | € 84 | € 87 | € 91 | € 79 | € 66 | € 51 | € 35 | € 18 | € 22 |
| FCFF | | € 270 | € 281 | € 292 | € 303 | € 316 | € 341 | € 366 | € 389 | € 411 | € 431 | € 431 |
| Cost of capital | | 6.96% | 6.96% | 6.96% | 6.96% | 6.96% | 6.96% | 6.97% | 6.98% | 6.99% | 7.00% | 7.00% |
| PV(FCFF) | | € 252 | € 245 | € 238 | € 232 | € 225 | € 228 | € 228 | € 227 | € 224 | € 220 | |
| Terminal value | € 6,835 | | | | | | | | | | | |
| PV(Terminal value) | € 3,485 | | | | | | | | | | | |
| PV (CF over next 10 years) | € 2,321 | | | | | | | | | | | |
| Value of operating assets = | € 5,806 | | | | | | | | | | | |
| - Debt | € 623 | | | | | | | | | | | |
| - Minority interests | € 13 | | | | | | | | | | | |
| + Cash | € 1,141 | | | | | | | | | | | |
| Value of equity | € 6,311 | | | | | | | | | | | |

High Prices
+ No selling
cost =
Preserve
current
operating
margin

Minimal
Reinvestment
due to low
growth

The super
rich are not
sensitive to
economic
downturns

Step 5: Keep the feedback loop

148

1. Not just car service company.: Uber is a car company, not just a car service company, and there may be a day when consumers will subscribe to a Uber service, rather than own their own cars. It could also expand into logistics, i.e., moving and transportation businesses.
2. Not just urban: Uber can create new demands for car service in parts of the country where taxis are not used (suburbia, small towns).
3. Global networking benefits: By linking with technology and credit card companies, Uber can have global networking benefits.

Valuing Bill Gurley's Uber narrative

| | <i>Uber (Gurley)</i> | <i>Uber (Gurley Mod)</i> | <i>Uber (Damodaran)</i> |
|----------------------|--|---|---|
| Narrative | Uber will <u>expand the car service market substantially</u> , bringing in mass transit users & non-users from the suburbs into the market, and use its <u>networking advantage</u> to gain a <u>dominant market share</u> , while maintaining its revenue slice at 20%. | Uber will <u>expand the car service market substantially</u> , bringing in mass transit users & non-users from the suburbs into the market, and use its <u>networking advantage</u> to gain a <u>dominant market share</u> , while cutting prices and margins (to 10%). | Uber will expand the car service market moderately, primarily in urban environments, and use its <u>competitive advantages</u> to get a <u>significant but not dominant market share</u> and maintain its revenue slice at 20%. |
| Total Market | \$300 billion, growing at 3% a year | \$300 billion, growing at 3% a year | \$100 billion, growing at 6% a year |
| Market Share | 40% | 40% | 10% |
| Uber's revenue slice | 20% | 10% | 20% |
| Value for Uber | \$53.4 billion + Option value of entering car ownership market (\$10 billion+) | \$28.7 billion + Option value of entering car ownership market (\$6 billion+) | \$5.9 billion + Option value of entering car ownership market (\$2-3 billion) |

Different narratives, Different Numbers

| <i>Total Market</i> | <i>Growth Effect</i> | <i>Network Effect</i> | <i>Competitive Advantages</i> | <i>Value of Uber</i> |
|-----------------------|----------------------------|-----------------------------------|-------------------------------|----------------------|
| A4. Mobility Services | B4. Double market size | C5. Strong global network effects | D4. Strong & Sustainable | \$90,457 |
| A3. Logistics | B4. Double market size | C5. Strong global network effects | D4. Strong & Sustainable | \$65,158 |
| A4. Mobility Services | B3. Increase market by 50% | C3. Strong local network effects | D3. Semi-strong | \$52,346 |
| A2. All car service | B4. Double market size | C5. Strong global network effects | D4. Strong & Sustainable | \$47,764 |
| A1. Urban car service | B4. Double market size | C5. Strong global network effects | D4. Strong & Sustainable | \$31,952 |
| A3. Logistics | B3. Increase market by 50% | C3. Strong local network effects | D3. Semi-strong | \$14,321 |
| A1. Urban car service | B3. Increase market by 50% | C3. Strong local network effects | D3. Semi-strong | \$7,127 |
| A2. All car service | B3. Increase market by 50% | C3. Strong local network effects | D3. Semi-strong | \$4,764 |
| A4. Mobility Services | B1. None | C1. No network effects | D1. None | \$1,888 |
| A3. Logistics | B1. None | C1. No network effects | D1. None | \$1,417 |
| A2. All car service | B1. None | C1. No network effects | D1. None | \$1,094 |
| A1. Urban car service | B1. None | C1. No network effects | D1. None | \$799 |

The Ferrari Counter Narrative

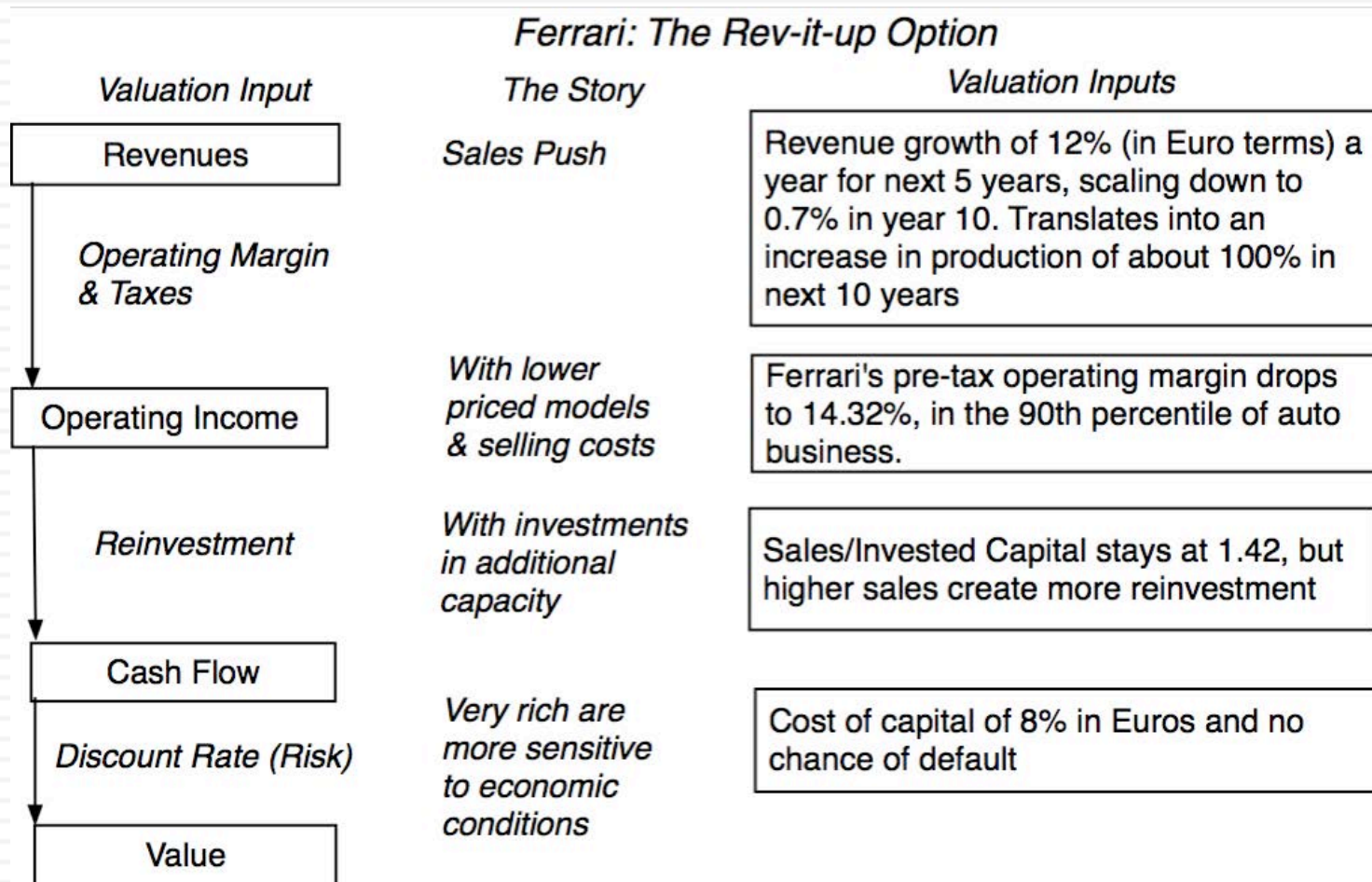

Ferrari: The “Rev-it-up” Alternative

Get less exclusive: Double number of cars sold over next decade

| | Base year | 1 | 2 | 3 | 4 | 5 | 6 | 7 | 8 | 9 | 10 | Terminal year |
|-----------------------------|-----------|---------|---------|---------|---------|---------|---------|---------|---------|---------|---------|---------------|
| Revenue growth rate | | 12.00% | 12.00% | 12.00% | 12.00% | 12.00% | 9.74% | 7.48% | 5.22% | 2.96% | 0.70% | 0.70% |
| Revenues | € 2,763 | € 3,095 | € 3,466 | € 3,882 | € 4,348 | € 4,869 | € 5,344 | € 5,743 | € 6,043 | € 6,222 | € 6,266 | € 6,309 |
| EBIT (Operating) margin | 18.20% | 17.81% | 17.42% | 17.04% | 16.65% | 16.26% | 15.87% | 15.48% | 15.10% | 14.71% | 14.32% | 14.32% |
| EBIT (Operating income) | € 503 | € 551 | € 604 | € 661 | € 724 | € 792 | € 848 | € 889 | € 912 | € 915 | € 897 | € 904 |
| Tax rate | 33.54% | 33.54% | 33.54% | 33.54% | 33.54% | 33.54% | 33.54% | 33.54% | 33.54% | 33.54% | 33.54% | 33.54% |
| EBIT(1-t) | € 334 | € 366 | € 401 | € 439 | € 481 | € 526 | € 564 | € 591 | € 606 | € 608 | € 596 | € 600 |
| - Reinvestment | | € 233 | € 261 | € 293 | € 328 | € 367 | € 334 | € 281 | € 211 | € 126 | € 31 | € 35 |
| FCFF | | € 133 | € 140 | € 147 | € 153 | € 159 | € 230 | € 310 | € 395 | € 482 | € 566 | € 565 |
| Cost of capital | | 8.00% | 8.00% | 8.00% | 8.00% | 8.00% | 7.90% | 7.80% | 7.70% | 7.60% | 7.50% | 7.50% |
| PV(FCFF) | | € 123 | € 120 | € 117 | € 113 | € 108 | € 145 | € 181 | € 215 | € 244 | € 266 | |
| Terminal value | € 8,315 | | | | | | | | | | | |
| PV(Terminal value) | € 3,906 | | | | | | | | | | | |
| PV (CF over next 10 years) | € 1,631 | | | | | | | | | | | |
| Value of operating assets = | € 5,537 | | | | | | | | | | | |
| - Debt | € 623 | | | | | | | | | | | |
| - Minority interests | € 13 | | | | | | | | | | | |
| + Cash | € 1,141 | | | | | | | | | | | |
| Value of equity | € 6,042 | | | | | | | | | | | |

Lower Prices +
Some selling cost = Lower operating margin

Reinvestment reflects higher sales

The very rich are more sensitive to economic conditions

And the world is full of feedback.. My Ferrari afterthought!



Step 6: Be ready to modify narrative as events unfold

154

| Narrative Break/End | Narrative Shift | Narrative Change (Expansion or Contraction) |
|---|--|--|
| Events, external (legal, political or economic) or internal (management, competitive, default), that can cause the narrative to break or end. | Improvement or deterioration in initial business model, changing market size, market share and/or profitability. | Unexpected entry/success in a new market or unexpected exit/failure in an existing market. |
| Your valuation estimates (cash flows, risk, growth & value) are no longer operative | Your valuation estimates will have to be modified to reflect the new data about the company. | Valuation estimates have to be redone with new overall market potential and characteristics. |
| Estimate a probability that it will occur & consequences | Monte Carlo simulations or scenario analysis | Real Options |

Uber: The September 2015 Update

| <i>Input</i> | <i>June 2014</i> | <i>September 2015</i> | <i>Rationale</i> |
|-------------------------|--|---|--|
| Total Market | \$100 billion; Urban car service | \$230 billion; Logistics | Market is broader, bigger & more global than I thought it would be. <u>Uber's</u> entry into delivery & moving businesses is now plausible, perhaps even probable. |
| Growth in market | Increase market size by 34%; CAGR of 6%. | Double market size; CAGR of 10.39%. | New customers being drawn to car sharing, with more diverse offerings. |
| Market Share | 10% (Local Networking) | 25% (Weak Global Networking) | Higher cost of entry will reduce competitors, but remaining competitors have access to capital & in Asia, the hometown advantage. |
| Slice of gross receipts | 20% (Left at status quo) | 15% | Increased competition will reduce car service company slice. |
| Operating margin | 40% (Low cost model) | 25% (Partial employee model) | Drivers will become partial employees, higher insurance and regulatory costs. |
| Cost of capital | 12% (Ninth decile of US companies) | 10% (75 th percentile of US companies) | Business model in place and substantial revenues. |
| Probability of failure | 10% | 0% | Enough cash on hand to find off threats to survival. |
| Value of equity | \$5.9 billion | \$23.4 billion | Value increased more than four fold. |

| Potential Market | Market size (in millions) |
|-----------------------|---------------------------|
| A1. Urban car service | \$100,000 |
| A2. All car service | \$175,000 |
| A3. Logistics | \$230,000 |
| A4. Mobility Services | \$310,000 |

| Growth Effect | CAGR (next 10 years) |
|---------------------------------|----------------------|
| B1. None | 3.00% |
| B2. Increase market by 25% | 5.32% |
| B3. Increase market size by 50% | 7.26% |
| B4: Double market size | 10.39% |

| Network Effects | Market Share |
|-----------------------------------|--------------|
| C1. No network effects | 5% |
| C2. Weak local network effects | 10% |
| C3. Strong local network effects | 15% |
| C4. Weak global network effects | 25% |
| C5. Strong global network effects | 40% |

Increases overall market to \$618 billion in year 10

| | Base | 2016 | 2017 | 2018 | 2019 | 2020 | 2021 | 2022 | 2023 | 2024 | 2025 | Assumptions |
|---------------------------------|-----------|-----------|-----------|-----------|-----------|-----------|-----------|-----------|-----------|-----------|-----------|-------------|
| Overall market | \$230,000 | \$253,897 | \$280,277 | \$309,398 | \$341,544 | \$377,031 | \$416,204 | \$459,448 | \$507,184 | \$559,881 | \$618,052 | A3 & B4 |
| Share of market (gross) | 4.71% | 6.74% | 8.77% | 10.80% | 12.83% | 14.86% | 16.89% | 18.91% | 20.94% | 22.97% | 25.00% | C4 |
| Gross Billings | \$10,840 | \$17,117 | \$24,582 | \$33,412 | \$43,813 | \$56,014 | \$70,277 | \$86,900 | \$106,218 | \$128,612 | \$154,513 | |
| Revenues as percent of gross | 20.00% | 19.50% | 19.00% | 18.50% | 18.00% | 17.50% | 17.00% | 16.50% | 16.00% | 15.50% | 15.00% | D3 |
| Annual Revenue | \$2,168 | \$3,338 | \$4,670 | \$6,181 | \$7,886 | \$9,802 | \$11,947 | \$14,338 | \$16,995 | \$19,935 | \$23,177 | |
| Operating margin | -23.06% | -18.26% | -13.45% | -8.64% | -3.84% | 0.97% | 5.77% | 10.58% | 15.39% | 20.19% | 25.00% | E2 |
| Operating Income | -\$500 | -\$609 | -\$628 | -\$534 | -\$303 | \$95 | \$690 | \$1,517 | \$2,615 | \$4,026 | \$5,794 | |
| Effective tax rate | 30.00% | 31.00% | 32.00% | 33.00% | 34.00% | 35.00% | 36.00% | 37.00% | 38.00% | 39.00% | 40.00% | |
| - Taxes | -\$150 | -\$189 | -\$201 | -\$176 | -\$103 | \$33 | \$248 | \$561 | \$994 | \$1,570 | \$2,318 | |
| After-tax operating income | -\$350 | -\$420 | -\$427 | -\$358 | -\$200 | \$62 | \$442 | \$956 | \$1,621 | \$2,456 | \$3,477 | |
| Sales/Capital Ratio | | 5.00 | 5.00 | 5.00 | 5.00 | 5.00 | 5.00 | 5.00 | 5.00 | 5.00 | 5.00 | F |
| - Reinvestment | | \$234 | \$267 | \$302 | \$341 | \$383 | \$429 | \$478 | \$531 | \$588 | \$648 | |
| Free Cash Flow to the Firm | | -\$654 | -\$694 | -\$660 | -\$541 | -\$322 | \$13 | \$478 | \$1,090 | \$1,868 | \$2,828 | |
| Terminal value | | | | | | | | | | | \$56,258 | |
| Present value of FCFF | | -\$595 | -\$573 | -\$496 | -\$369 | -\$200 | \$7 | \$248 | \$520 | \$822 | \$1,152 | |
| Present value of terminal value | | | | | | | | | | | \$22,914 | |
| Cost of capital | 10.00% | 10.00% | 10.00% | 10.00% | 10.00% | 10.00% | 9.60% | 9.20% | 8.80% | 8.40% | 8.00% | G1 |

| | | |
|---|----------|----|
| PV of cash flows during next 10 years = | \$515 | |
| PV of terminal value = | \$22,914 | |
| Value of operating assets | \$23,429 | |
| Probability of failure | 0.00% | G2 |
| Adjusted value of operating assets | \$23,429 | |
| Less Debt | \$0 | |
| Value of Equity | \$23,429 | |

Capital Intensity
F: Status Quo: Sales/Capital = 5

| Expense Profile | Operating Margin |
|----------------------------|------------------|
| E1: Independent contractor | 40% |
| E2: Partial employee | 25% |
| E3: Full employee | 15% |

| Competitive Advantages | Slice of Gross Receipts |
|--------------------------|-------------------------|
| D1. None | 5% |
| D2. Weak | 10% |
| D3. Semi-strong | 15% |
| D4. Strong & Sustainable | 20% |

Risk Estimates

- G1. Cost of capital at 75th percentile of US companies = 10%
G2. Probability of failure in next 10 years= 0%

Uber Valuation: September 2015

Aswath Damodaran



RELATIVE VALUATION (PRICING)

Aswath Damodaran

Relative valuation is pervasive...

- Most asset valuations are relative.
- Most equity valuations on Wall Street are relative valuations.
 - Almost 85% of equity research reports are based upon a multiple and comparables.
 - More than 50% of all acquisition valuations are based upon multiples
 - Rules of thumb based on multiples are not only common but are often the basis for final valuation judgments.
- While there are more discounted cashflow valuations in consulting and corporate finance, they are often relative valuations masquerading as discounted cash flow valuations.
 - The objective in many discounted cashflow valuations is to back into a number that has been obtained by using a multiple.
 - The terminal value in a significant number of discounted cashflow valuations is estimated using a multiple.

The Reasons for the allure...

- “If you think I’ m crazy, you should see the guy who lives across the hall”

Jerry Seinfeld talking about Kramer in a Seinfeld episode

- “ A little inaccuracy sometimes saves tons of explanation”

H.H. Munro

- “ If you are going to screw up, make sure that you have lots of company”

Ex-portfolio manager

Pricing versus Valuation

160

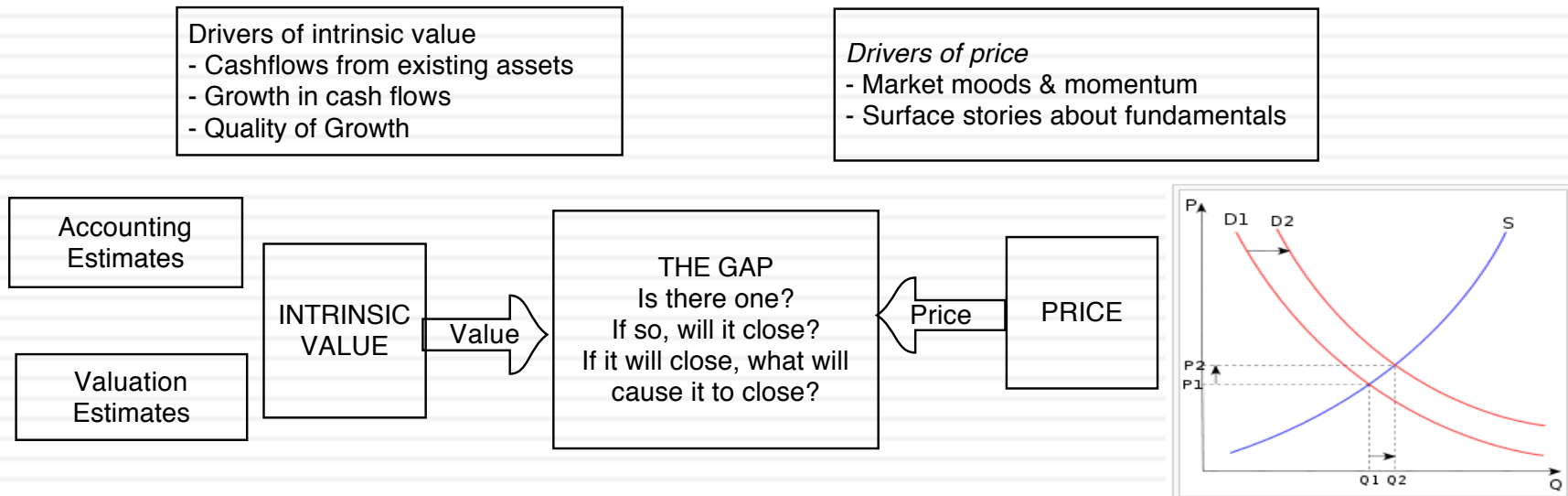

Test 1: Are you pricing or valuing?

5369 La Jolla Mesa Dr
La Jolla, CA 92037
Status: Active

\$995,000
Price

3
Beds

2.5
Baths

1,440 Sq. Ft.
\$691 / Sq. Ft.

Built: 1955 Lot Size: 3,000 Sq. Ft. On Redfin: 12 days

Favorite X-Out Share... Tour Home

Overview Property Details Tour Insights Property History Public Records Activity Schools Neighborhood & Offer Insights Similar Homes



Lisa Padilla
REDFIN Real Estate Agent

★★★★★
47 client reviews

\$8,726 commission refund

Go Tour This Home

Ask Lisa a Question or Start an Offer

1 of 4 Redfin Agents in this area

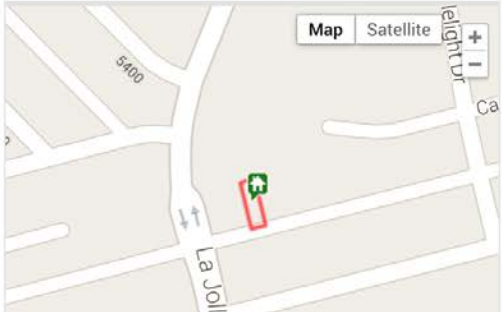

1 of 25  Play Video

Test 2: Are you pricing or valuing?

162

Europe
Switzerland

Biotechnology
Biotechnology

Reuters BION.S Bloomberg BION SW Exchange SWX Ticker BION

| | |
|----------------------------|----------------|
| Price at 12 Aug 2013 (CHF) | 124.00 |
| Price Target (CHF) | 164.50 |
| 52-week range (CHF) | 128.40 - 84.90 |

Strong sector and stock-picking continue

Impressive performance

Over the past two years, BB Biotech shares have roughly tripled, which could tempt investors to take profits. However, this performance has been well backed by a deserved revival of the biotech industry, encouraging fundamental news, M&A, and increased money flow into health care stocks. In addition, BBB returned to index outperformance by modifying its stock-picking approach. Hence, despite excellent performance, the shares still trade at a 23% discount to the net asset value of the portfolio. Hence, the shares are an attractive value vehicle to capture growth opportunities in an attractive sector.

Biotech industry remains attractive

With the re-rating of the pharma sector, investors have also showed increased interest in biotech stocks. Established biotech stocks have delivered encouraging financial results and approvals, while there has also been substantial industry consolidation, which is not surprising in times of "cheap" money and high liquidity. BB Biotech remains an attractive vehicle to capture the future potential of the biotech sector. In addition, investors benefit from a 23% discount to NAV and attractive cash distribution policy of 5% yield p.a. Hence, we reiterate our Buy on BB Biotech shares.

Key changes

Target Price 106.50 to 164.50 ↑ 54.5%

Source: Deutsche Bank

Price/price relative

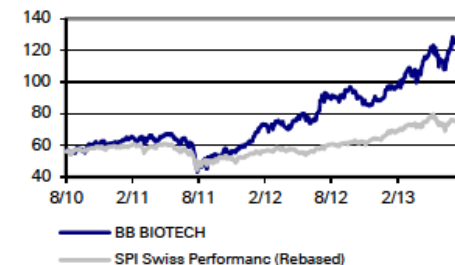

| Performance (%) | 1m | 3m | 12m |
|-----------------|------|-----|------|
| Absolute | -1.4 | 5.4 | 37.4 |

Test 3: Are you pricing or valuing?

163

| | 1 | 2 | 3 | 4 | 5 |
|---------------------------------|-------------------|----------|----------|----------|------------|
| EBITDA | \$100.00 | \$120.00 | \$144.00 | \$172.80 | \$207.36 |
| - Depreciation | \$20.00 | \$24.00 | \$28.80 | \$34.56 | \$41.47 |
| EBIT | \$80.00 | \$96.00 | \$115.20 | \$138.24 | \$165.89 |
| - Taxes | \$24.00 | \$28.80 | \$34.56 | \$41.47 | \$49.77 |
| EBIT (1-t) | \$56.00 | \$67.20 | \$80.64 | \$96.77 | \$116.12 |
| + Depreciation | \$20.00 | \$24.00 | \$28.80 | \$34.56 | \$41.47 |
| - Cap Ex | \$50.00 | \$60.00 | \$72.00 | \$86.40 | \$103.68 |
| - Chg in WC | \$10.00 | \$12.00 | \$14.40 | \$17.28 | \$20.74 |
| FCFF | \$16.00 | \$19.20 | \$23.04 | \$27.65 | \$33.18 |
| Terminal Value | | | | | \$1,658.88 |
| Cost of capital | 8.25% | 8.25% | 8.25% | 8.25% | 8.25% |
| Present Value | \$14.78 | \$16.38 | \$18.16 | \$20.14 | \$1,138.35 |
| Value of operating assets today | \$1,207.81 | | | | |
| + Cash | \$125.00 | | | | |
| - Debt | \$200.00 | | | | |
| Value of equity | \$1,132.81 | | | | |

The tool for pricing: A multiple

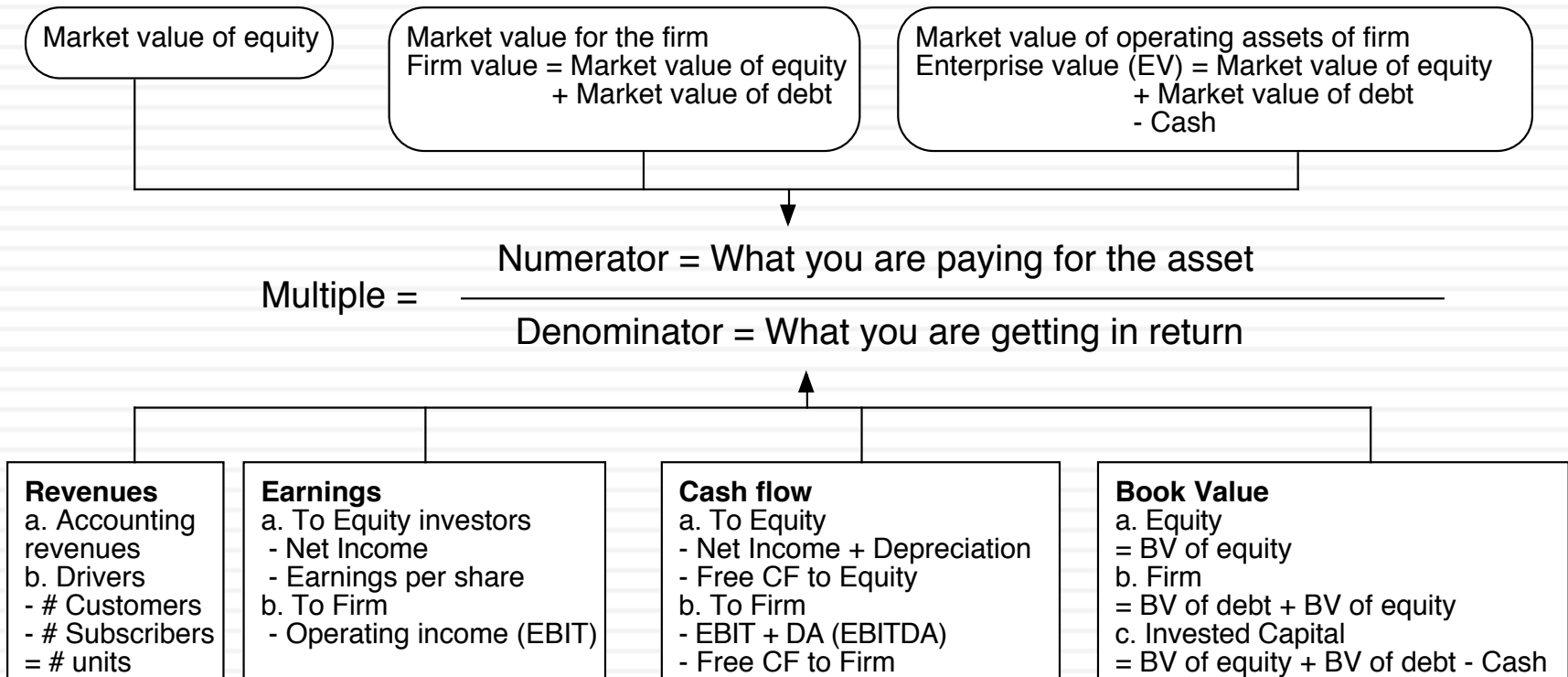

The Four Steps to Deconstructing Multiples

- Define the multiple
 - In use, the same multiple can be defined in different ways by different users. When comparing and using multiples, estimated by someone else, it is critical that we understand how the multiples have been estimated
- Describe the multiple
 - Too many people who use a multiple have no idea what its cross sectional distribution is. If you do not know what the cross sectional distribution of a multiple is, it is difficult to look at a number and pass judgment on whether it is too high or low.
- Analyze the multiple
 - It is critical that we understand the fundamentals that drive each multiple, and the nature of the relationship between the multiple and each variable.
- Apply the multiple
 - Defining the comparable universe and controlling for differences is far more difficult in practice than it is in theory.

Definitional Tests

- Is the multiple consistently defined?
 - Proposition 1: Both the value (the numerator) and the standardizing variable (the denominator) should be to the same claimholders in the firm. In other words, the value of equity should be divided by equity earnings or equity book value, and firm value should be divided by firm earnings or book value.
- Is the multiple uniformly estimated?
 - The variables used in defining the multiple should be estimated uniformly across assets in the “comparable firm” list.
 - If earnings-based multiples are used, the accounting rules to measure earnings should be applied consistently across assets. The same rule applies with book-value based multiples.

Example 1: Price Earnings Ratio: Definition

$$PE = \text{Market Price per Share} / \text{Earnings per Share}$$

- There are a number of variants on the basic PE ratio in use. They are based upon how the price and the earnings are defined.

Price: is usually the current price

is sometimes the average price for the year

EPS: EPS in most recent financial year

EPS in trailing 12 months (Trailing PE)

Forecasted EPS next year (Forward PE)

Forecasted EPS in future year

Example 2: Enterprise Value /EBITDA Multiple

- The enterprise value to EBITDA multiple is obtained by netting cash out against debt to arrive at enterprise value and dividing by EBITDA.

$$\frac{\text{Enterprise Value}}{\text{EBITDA}} = \frac{\text{Market Value of Equity} + \text{Market Value of Debt} - \text{Cash}}{\text{Earnings before Interest, Taxes and Depreciation}}$$

- Why do we net out cash from firm value?
- What happens if a firm has cross holdings which are categorized as:
 - ▣ Minority interests?
 - ▣ Majority active interests?

Descriptive Tests

- What is the average and standard deviation for this multiple, across the universe (market)?
- What is the median for this multiple?
 - The median for this multiple is often a more reliable comparison point.
- How large are the outliers to the distribution, and how do we deal with the outliers?
 - Throwing out the outliers may seem like an obvious solution, but if the outliers all lie on one side of the distribution (they usually are large positive numbers), this can lead to a biased estimate.
- Are there cases where the multiple cannot be estimated? Will ignoring these cases lead to a biased estimate of the multiple?
- How has this multiple changed over time?

1. Multiples have skewed distributions...

PE Ratios: US companies in January 2016

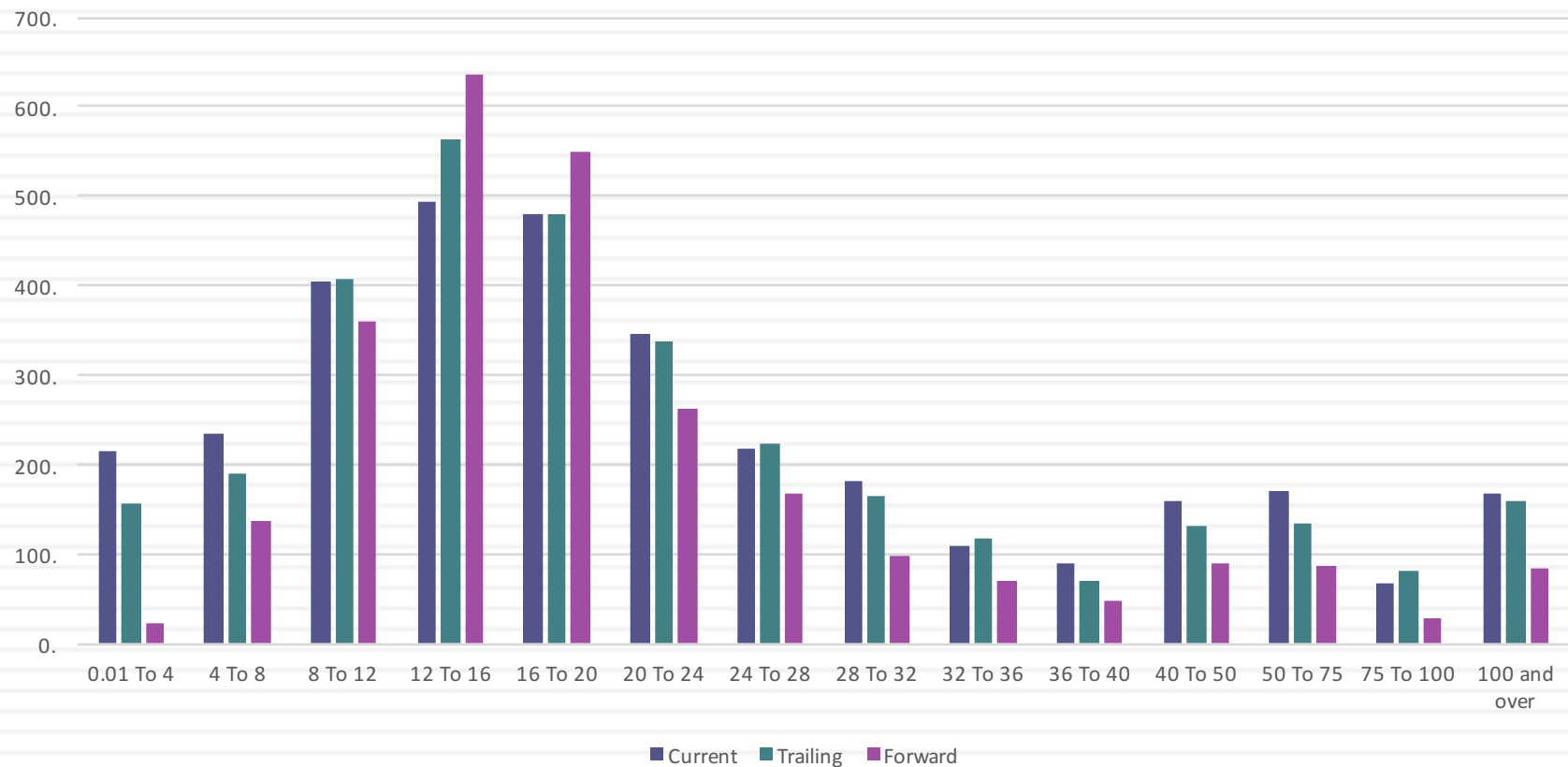

2. Making statistics “dicey”

171

| | Current PE | Trailing PE | Forward PE |
|--------------------|------------|-------------|------------|
| Number of firms | 7480 | 7480 | 7480 |
| Number with PE | 3,344. | 3,223. | 2,647. |
| Average | 59.42 | 46.04 | 29.63 |
| Median | 18.53 | 18.29 | 16.98 |
| Minimum | 0.11 | 0.28 | 0.15 |
| Maximum | 32,269.00 | 6,900.00 | 2,748.00 |
| Standard deviation | 777.02 | 256.06 | 81.27 |
| Standard error | 13.44 | 4.51 | 1.58 |
| Skewness | 37.27 | 19.9 | 18.74 |
| 25th percentile | 11.88 | 12.32 | 13.1 |
| 75th percentile | 30.25 | 29.52 | 24.28 |

US firms in January 2016

3. Markets have a lot in common : Comparing Global PEs

172

Trailing PE Ratios by Region

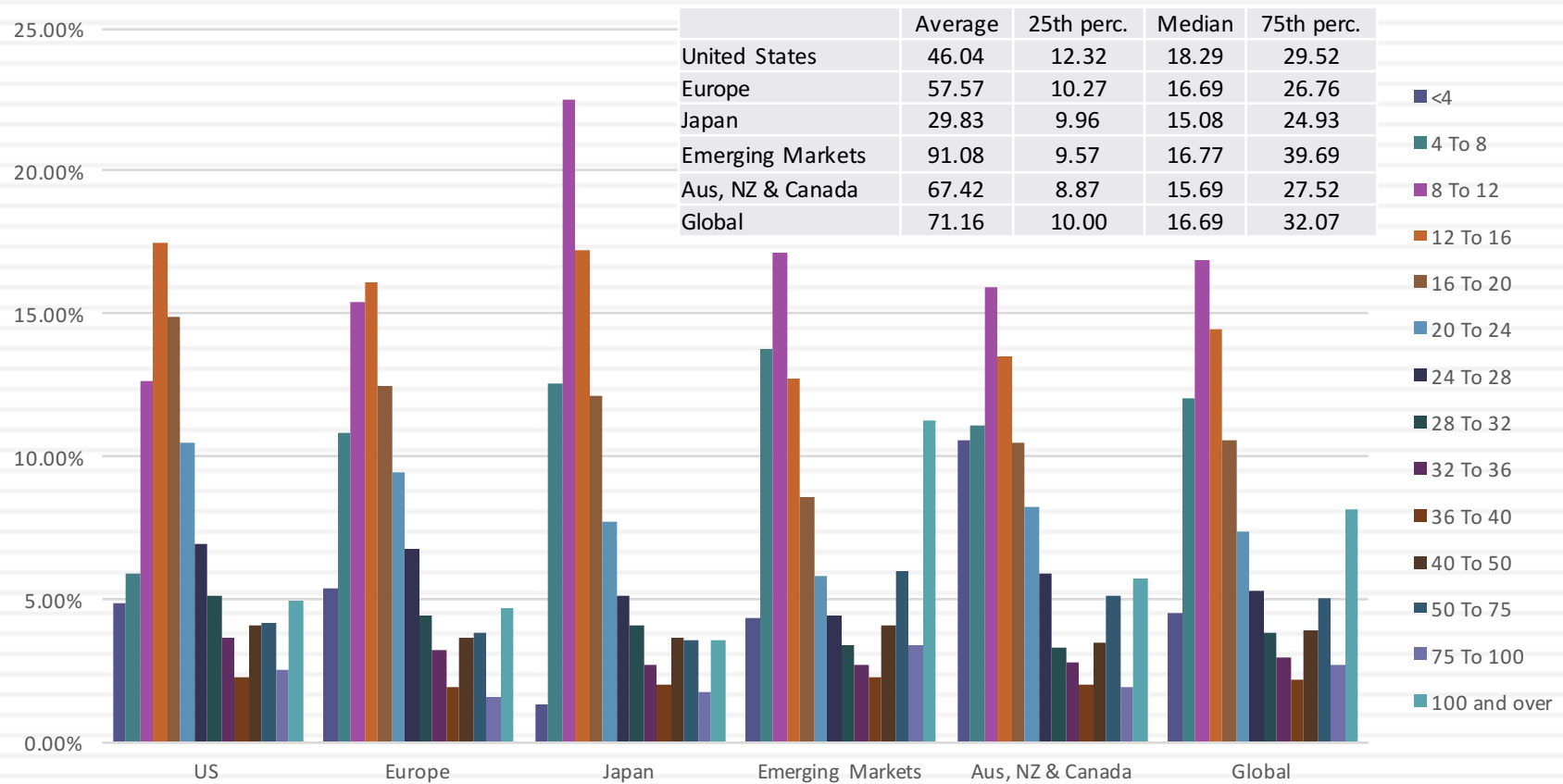

And South East Asia is not unique..

PE Ratios for SE Asia: July 2016

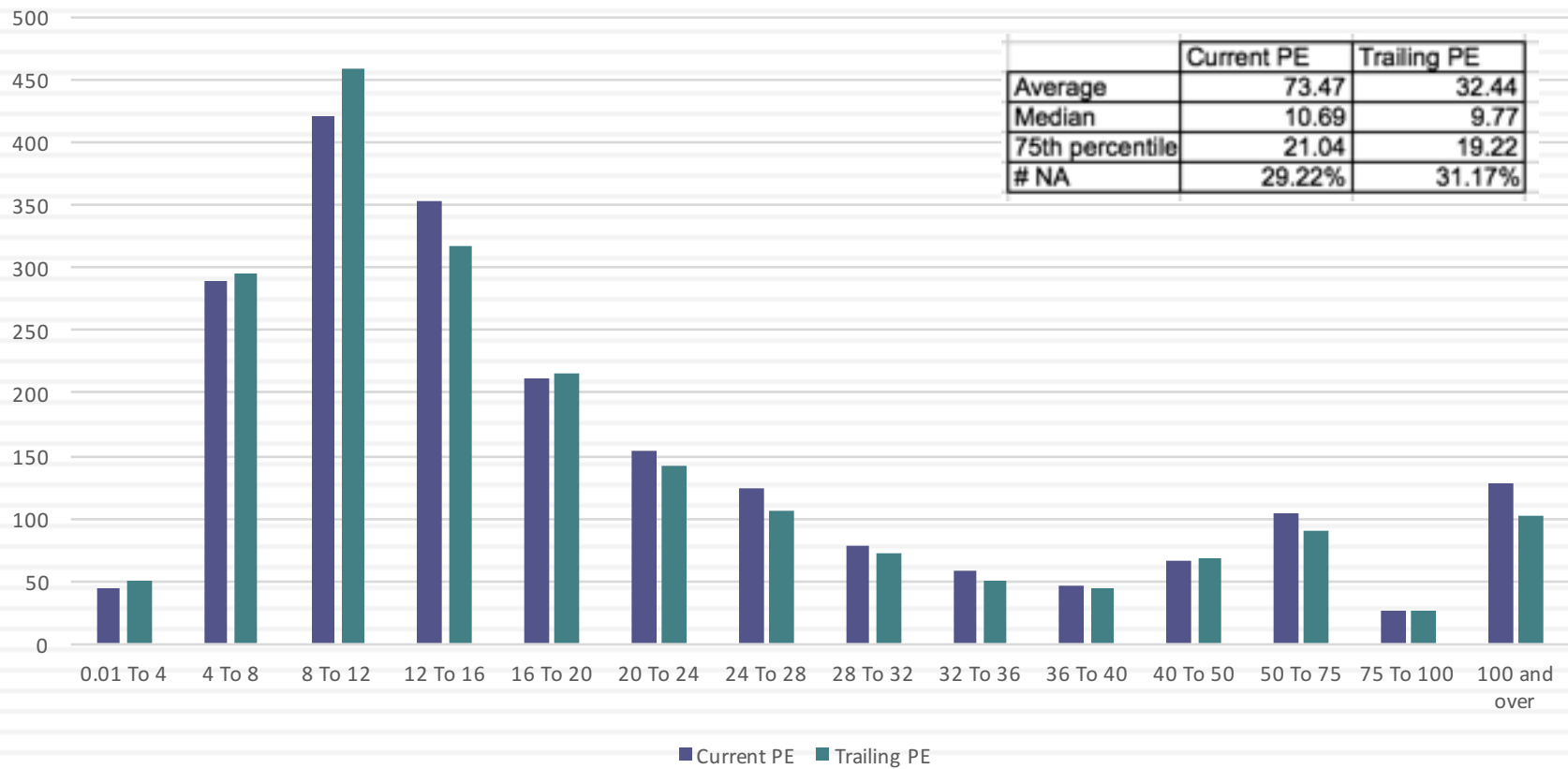

4. Simplistic rules almost always break down...6 times EBITDA may not be cheap...

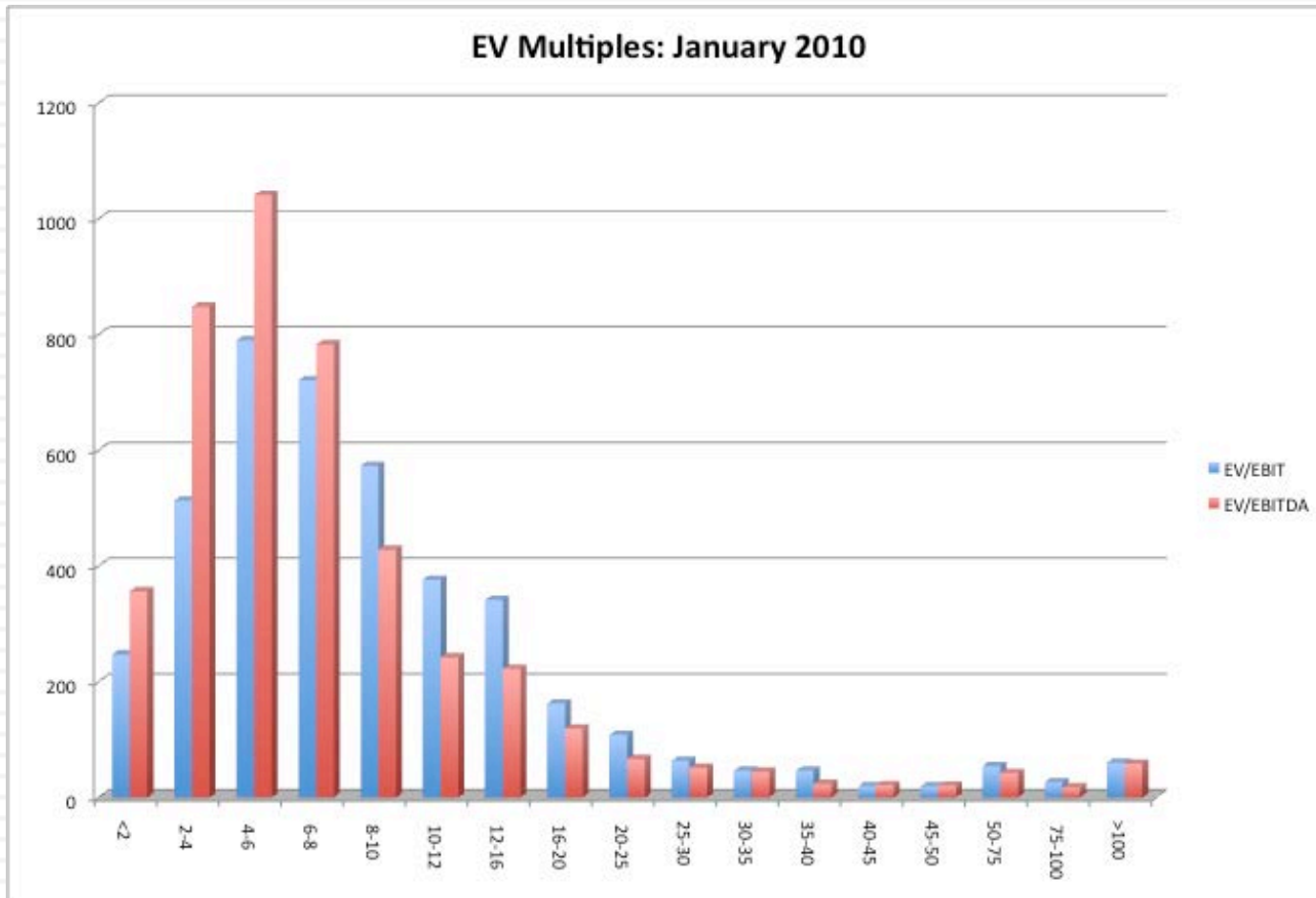

But it may be in 2016, unless you are in Japan, Australia or Canada

EV/EBITDA Multiples in January 2016

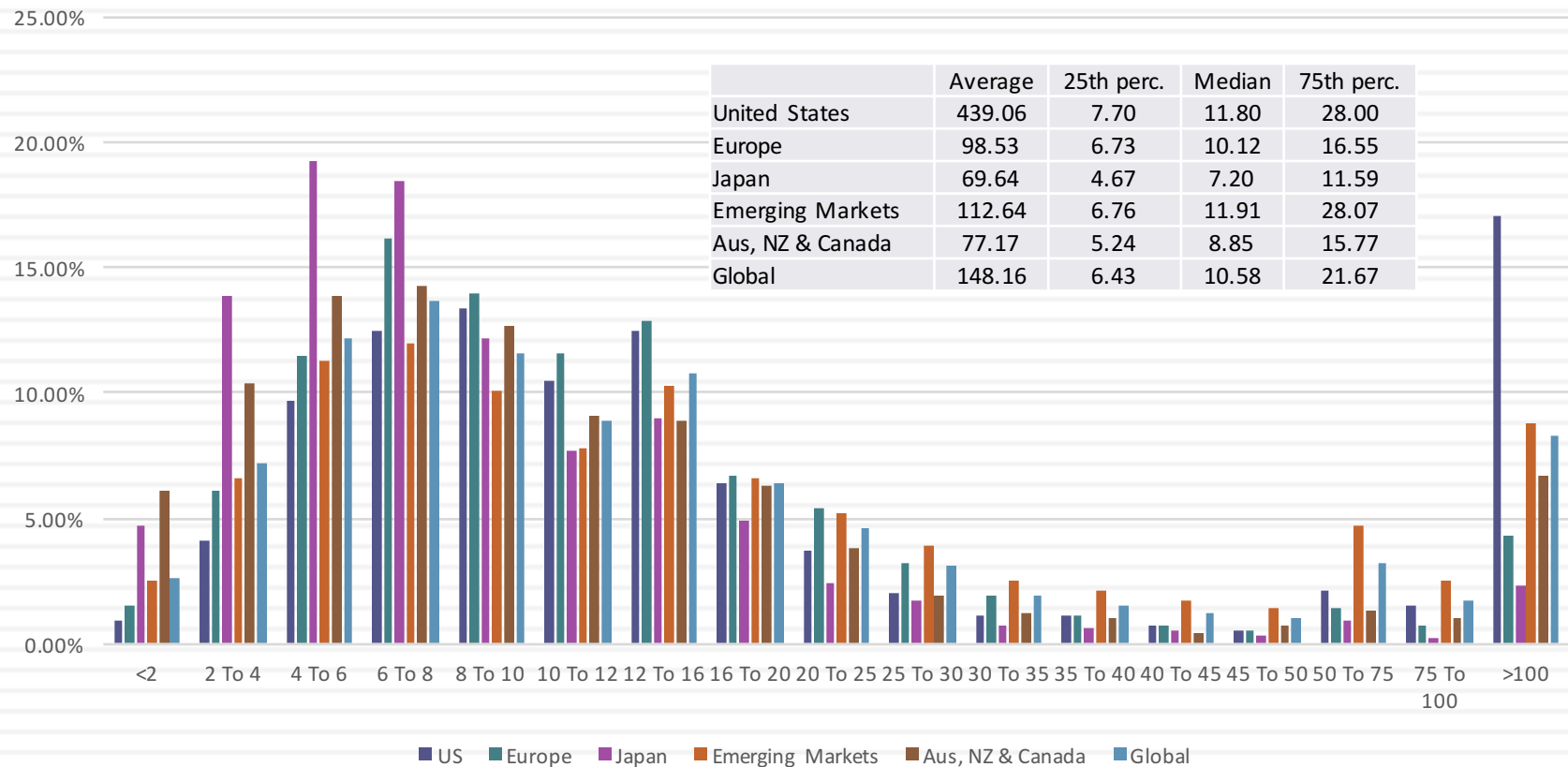

Analytical Tests

- What are the fundamentals that determine and drive these multiples?
 - Proposition 2: Embedded in every multiple are all of the variables that drive every discounted cash flow valuation - growth, risk and cash flow patterns.
 - In fact, using a simple discounted cash flow model and basic algebra should yield the fundamentals that drive a multiple
- How do changes in these fundamentals change the multiple?
 - The relationship between a fundamental (like growth) and a multiple (such as PE) is seldom linear. For example, if firm A has twice the growth rate of firm B, it will generally not trade at twice its PE ratio
 - Proposition 3: It is impossible to properly compare firms on a multiple, if we do not know the nature of the relationship between fundamentals and the multiple.

PE Ratio: Understanding the Fundamentals

- To understand the fundamentals, start with a basic equity discounted cash flow model.
- With the dividend discount model,

$$P_0 = \frac{DPS_1}{r - g_n}$$

- Dividing both sides by the current earnings per share,

$$\frac{P_0}{EPS_0} = PE = \frac{\text{Payout Ratio} * (1 + g_n)}{r - g_n}$$

- If this had been a FCFE Model,

$$P_0 = \frac{FCFE_1}{r - g_n}$$

$$\frac{P_0}{EPS_0} = PE = \frac{(\text{FCFE/Earnings}) * (1 + g_n)}{r - g_n}$$

The Determinants of Multiples...

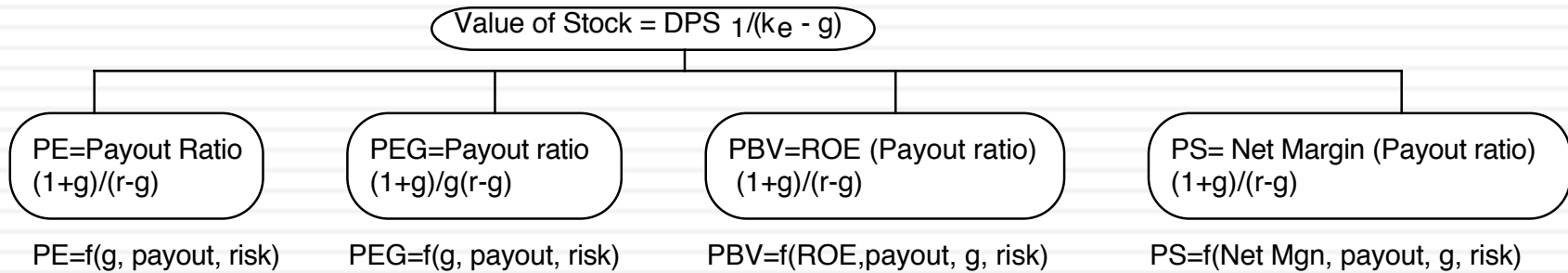

Equity Multiples

Firm Multiples

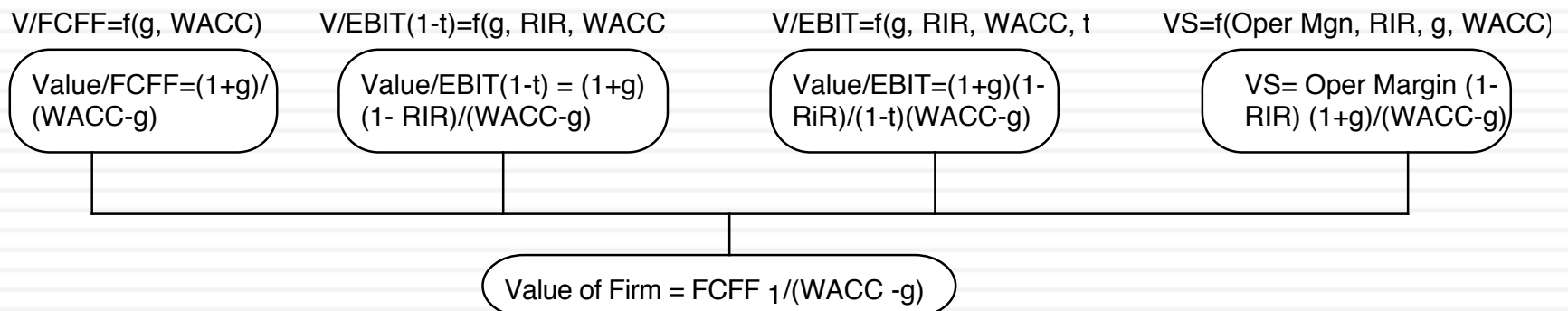

Application Tests

- Given the firm that we are valuing, what is a “comparable” firm?
 - ▣ While traditional analysis is built on the premise that firms in the same sector are comparable firms, valuation theory would suggest that a comparable firm is one which is similar to the one being analyzed in terms of fundamentals.
 - ▣ Proposition 4: There is no reason why a firm cannot be compared with another firm in a very different business, if the two firms have the same risk, growth and cash flow characteristics.
- Given the comparable firms, how do we adjust for differences across firms on the fundamentals?
 - ▣ Proposition 5: It is impossible to find an exactly identical firm to the one you are valuing.

An Example: Comparing PE Ratios across a Sector: PE

| <i>Company Name</i> | <i>PE</i> | <i>Growth</i> |
|---|-------------|---------------|
| <i>PT Indosat ADR</i> | <i>7.8</i> | <i>0.06</i> |
| <i>Telebras ADR</i> | <i>8.9</i> | <i>0.075</i> |
| <i>Telecom Corporation of New Zealand ADR</i> | <i>11.2</i> | <i>0.11</i> |
| <i>Telecom Argentina Stet - France Telecom SA ADR B</i> | <i>12.5</i> | <i>0.08</i> |
| <i>Hellenic Telecommunication Organization SA ADR</i> | <i>12.8</i> | <i>0.12</i> |
| <i>Telecomunicaciones de Chile ADR</i> | <i>16.6</i> | <i>0.08</i> |
| <i>Swisscom AG ADR</i> | <i>18.3</i> | <i>0.11</i> |
| <i>Asia Satellite Telecom Holdings ADR</i> | <i>19.6</i> | <i>0.16</i> |
| <i>Portugal Telecom SA ADR</i> | <i>20.8</i> | <i>0.13</i> |
| <i>Telefonos de Mexico ADR L</i> | <i>21.1</i> | <i>0.14</i> |
| <i>Matav RT ADR</i> | <i>21.5</i> | <i>0.22</i> |
| <i>Telstra ADR</i> | <i>21.7</i> | <i>0.12</i> |
| <i>Gilat Communications</i> | <i>22.7</i> | <i>0.31</i> |
| <i>Deutsche Telekom AG ADR</i> | <i>24.6</i> | <i>0.11</i> |
| <i>British Telecommunications PLC ADR</i> | <i>25.7</i> | <i>0.07</i> |
| <i>Tele Danmark AS ADR</i> | <i>27</i> | <i>0.09</i> |
| <i>Telekomunikasi Indonesia ADR</i> | <i>28.4</i> | <i>0.32</i> |
| <i>Cable & Wireless PLC ADR</i> | <i>29.8</i> | <i>0.14</i> |
| <i>APT Satellite Holdings ADR</i> | <i>31</i> | <i>0.33</i> |
| <i>Telefonica SA ADR</i> | <i>32.5</i> | <i>0.18</i> |
| <i>Royal KPN NV ADR</i> | <i>35.7</i> | <i>0.13</i> |
| <i>Telecom Italia SPA ADR</i> | <i>42.2</i> | <i>0.14</i> |
| <i>Nippon Telegraph & Telephone ADR</i> | <i>44.3</i> | <i>0.2</i> |
| <i>France Telecom SA ADR</i> | <i>45.2</i> | <i>0.19</i> |
| <i>Korea Telecom ADR</i> | <i>71.3</i> | <i>0.44</i> |

Indofood: A Relative Valuation

| Company Name | Current PE | Trailing PE | Forward PE | PEG | PBV | PS | EV/EBIT | EV/EBITDA | EV/Invested Capital | EV/Sales |
|---|----------------|---------------|--------------|---------------|----------------|---------------|----------------|----------------|---------------------|--------------|
| PT Indofood Sukses Makmur Tbk (JKSE:INDF) | 22.41 | 20.15 | 14.08 | 2.24 | 1.44 | 1.04 | 10.68 | 8.04 | 1.43 | 1.28 |
| PT Mayora Indah Tbk (JKSE:MYOR) | 29.95 | 27.72 | 25.30 | 1.48 | 6.38 | 2.47 | 18.00 | 14.60 | 4.78 | 2.63 |
| PT Inti Agri Resources Tbk (JKSE:IIKP) | NA | NA | NA | NA | 40.77 | 669.24 | NA | NA | 39.44 | 669.81 |
| PT Ultrajaya Milk Industry & Trading Company Tbk. (JKSE:ULTJ) | 25.10 | 23.42 | 20.44 | NA | 4.23 | 2.96 | 16.25 | 13.41 | 5.71 | 2.75 |
| PT Japfa Comfeed Indonesia Tbk (JKSE:JPFA) | 26.36 | 12.29 | 14.00 | NA | 1.85 | 0.49 | 8.82 | 6.86 | 1.45 | 0.74 |
| PT Sinar Mas Agro Resources & Technology Tbk (JKSE:SMAR) | NA | 63.04 | NA | NA | 1.21 | 0.28 | 23.34 | 13.61 | 1.09 | 0.60 |
| PT Nippon Indosari Corpindo Tbk (JKSE:ROTI) | 30.52 | 27.44 | 29.50 | 1.02 | 6.24 | 3.80 | 17.77 | 14.37 | 4.91 | 4.00 |
| PT Salim Ivomas Pratama (JKSE:SIMP) | 27.73 | 24.77 | 11.33 | 1.41 | 0.41 | 0.53 | 10.63 | 5.76 | 0.66 | 1.14 |
| PT Siantar Top Tbk (JKSE:STTP) | 32.45 | 31.52 | NA | NA | 5.50 | 2.38 | 22.25 | 18.07 | 3.93 | 2.61 |
| PT Tiga Pilar Sejahtera Food Tbk (JKSE:AISA) | 15.79 | 15.26 | 12.78 | 1.10 | 1.19 | 0.85 | 10.70 | 8.85 | 1.12 | 1.48 |
| PT Dua Putra Utama Makmur Tbk (JKSE:DPUM) | 63.56 | 68.29 | NA | NA | 3.93 | 6.75 | 46.12 | 42.84 | 3.66 | 6.92 |
| PT Provident Agro Tbk (JKSE:PALM) | NA | NA | NA | NA | 2.03 | 3.35 | 26.69 | 21.84 | 1.43 | 5.70 |
| PT Central Proteina Prima Tbk (JKSE:CPRO) | NA | NA | NA | NA | 1.01 | 0.24 | NA | 30.04 | 1.00 | 0.78 |
| PT Sierad Produce Tbk (JKSE:SIPD) | NA | NA | NA | NA | 0.78 | 0.29 | NA | NA | 0.92 | 0.85 |
| PT Wilmar Cahaya Indonesia Tbk (JKSE:CEKA) | 5.74 | 3.72 | NA | NA | 0.82 | 0.18 | 3.81 | 3.52 | 0.88 | 0.29 |
| PT. Sekar Bumi, Tbk. (JKSE:SKBM) | 14.14 | 14.14 | NA | NA | 1.71 | 0.43 | 12.65 | 10.54 | 1.49 | 0.55 |
| PT Gozco Plantations Tbk (JKSE:GZCO) | NA | NA | NA | NA | 0.16 | 0.87 | NA | 19.54 | 0.54 | 4.70 |
| PT Budi Starch & Sweetener Tbk (JKSE:BUDI) | 16.83 | 10.72 | NA | NA | 0.28 | 0.14 | 10.62 | 6.03 | 0.65 | 0.65 |
| PT Dharma Samudera Fishing Industries Tbk (JKSE:DSFI) | 18.55 | 19.83 | NA | NA | 1.67 | 0.45 | 15.40 | 10.64 | 1.42 | 0.61 |
| Median | 25.10 | 21.78 | 14.08 | 1.41 | 1.67 | 0.85 | 15.40 | 13.41 | 1.43 | 1.28 |
| Indofoods vs Median | -10.71% | -7.52% | 0.00% | 59.21% | -13.62% | 22.45% | -30.64% | -40.05% | 0.16% | 0.00% |

Indofood: Controlling for differences

| Company Name | Liquidity Ratio | Book Debt to capital ratio | Market Debt to capital ratio | Standard deviation in stock price | Return on Equity | Return on Capital (ROC or ROIC) | Net Profit Margin | Pre-tax Operating Margin | Historical growth in Revenues - Last 3 years | Historical growth in Revenues - Last 5 years | Expected growth rate in EPS- Next 5 years | Expected growth in revenues - Next 2 years |
|---|-----------------|----------------------------|------------------------------|-----------------------------------|------------------|---------------------------------|-------------------|--------------------------|--|--|---|--|
| PT Indofood CBP Sukses Makmur Tbk (JKSE:ICBP) | 0.10 | 12.86% | 2.49% | 23.56% | 21.38% | 35.30% | 9.63% | 13.22% | 13.20% | 12.30% | 11.30% | 11.10% |
| PT Indofood Sukses Makmur Tbk (JKSE:INDF) | 0.24 | 38.46% | 30.23% | 24.55% | 11.96% | 13.23% | 4.86% | 11.28% | 8.54% | 10.50% | 10.00% | 9.37% |
| PT Mayora Indah Tbk (JKSE:MYOR) | 0.01 | 43.39% | 10.73% | 28.72% | 29.16% | 21.85% | 7.92% | 13.00% | 14.70% | 15.90% | 20.20% | 15.70% |
| PT Inti Agri Resources Tbk (JKSE:IIKP) | 0.05 | 3.41% | 0.09% | NA | -4.55% | -4.83% | -77.70% | -85.81% | -3.78% | -6.79% | NA | NA |
| PT Ultrajaya Milk Industry & Trading Company | 0.01 | 3.33% | 0.81% | 17.57% | 21.93% | 28.21% | 12.03% | 16.06% | 14.50% | 18.00% | NA | 16.40% |
| PT Japfa Comfeed Indonesia Tbk (JKSE:JPFA) | 0.15 | 51.89% | 36.77% | 45.22% | 20.43% | 13.39% | 3.79% | 7.89% | 10.80% | 12.20% | NA | 14.70% |
| PT Sinar Mas Agro Resources & Technology Tbk | 0.00 | 58.75% | 54.16% | NA | 1.93% | 2.76% | 0.42% | 2.44% | 13.10% | 8.86% | NA | NA |
| PT Nippon Indosari Corpindo Tbk (JKSE:ROTI) | 0.10 | 43.85% | 11.12% | 26.72% | 27.74% | 20.76% | 12.79% | 20.83% | 21.20% | 28.60% | 30.00% | 18.90% |
| PT Salim Ivomas Pratama (JKSE:SIMP) | 0.08 | 35.92% | 57.76% | 27.81% | 2.02% | 3.78% | 2.00% | 10.01% | 1.39% | 6.82% | 19.70% | 9.22% |
| PT Siantar Top Tbk (JKSE:STTP) | 0.00 | 35.31% | 9.03% | 17.55% | 21.29% | 15.69% | 7.15% | 11.11% | 23.30% | 24.60% | NA | NA |
| PT Tiga Pilar Sejahtera Food Tbk (JKSE:AISA) | 0.44 | 50.48% | 46.05% | 26.85% | 9.98% | 10.81% | 5.30% | 13.22% | 26.10% | 45.00% | 14.40% | 15.10% |
| PT Dua Putra Utama Makmur Tbk (JKSE:DPUM) | 0.09 | 19.13% | 5.68% | NA | NA | NA | 8.76% | 13.31% | NA | NA | NA | NA |
| PT Provident Agro Tbk (JKSE:PALM) | 0.00 | 59.13% | 41.62% | NA | -0.82% | 5.82% | -1.26% | 20.28% | 19.90% | NA | NA | NA |
| PT Central Proteina Prima Tbk (JKSE:CPRO) | 0.09 | 70.72% | 70.55% | 33.68% | -49.27% | -0.79% | -10.44% | -0.54% | 10.60% | 6.49% | NA | NA |
| PT Sierad Produce Tbk (JKSE:SIPD) | 0.09 | 60.31% | 66.08% | NA | -17.99% | -8.95% | -9.52% | -8.44% | -21.20% | -10.60% | NA | NA |
| PT Wilmar Cahaya Indonesia Tbk (JKSE:CEKA) | 0.04 | 36.41% | 41.01% | NA | 27.67% | 19.34% | 4.49% | 7.20% | 45.90% | 33.60% | NA | NA |
| PT. Sekar Bumi, Tbk. (JKSE:SKBM) | 0.01 | 43.72% | 31.18% | NA | 14.88% | 12.23% | 3.06% | 4.34% | 21.80% | NA | NA | NA |
| PT Gozco Plantations Tbk (JKSE:GZCO) | 0.14 | 41.52% | 81.78% | 43.40% | -5.27% | -1.20% | -15.83% | -6.24% | 10.10% | 2.69% | NA | NA |
| PT Budi Starch & Sweetener Tbk (JKSE:BUDI) | 0.03 | 54.59% | 80.88% | 20.40% | 3.46% | 3.19% | 1.19% | 5.58% | 3.00% | 1.73% | NA | NA |
| PT Dharma Samudera Fishing Industries Tbk | 2.19 | 38.87% | 27.58% | NA | 9.72% | 5.93% | 2.15% | 3.77% | 22.00% | 34.00% | NA | NA |
| Median | 0.09 | 0.42 | 0.34 | 0.27 | 0.10 | 0.11 | 0.03 | 0.09 | 0.13 | 0.12 | 0.17 | 0.15 |
| Indofoods vs Median | 15.91% | -69.70% | -92.66% | -12.03% | 114.37% | 226.59% | 181.22% | 47.66% | 0.00% | 0.82% | -33.72% | -25.50% |

Comparisons to the entire market: Why not?

- In contrast to the 'comparable firm' approach, the information in the entire cross-section of firms can be used to predict PE ratios.
- The simplest way of summarizing this information is with a multiple regression, with the PE ratio as the dependent variable, and proxies for risk, growth and payout forming the independent variables.

PEG Ratio Regression - US stocks

January 2016

185

Model Summary^{a,c,d}

| Model | R | R Square | Adjusted R Square | Std. Error of the Estimate |
|-------|-------------------|----------|-------------------|----------------------------|
| 1 | .717 ^b | .514 | .513 | 133.686530 |

a. Broad Group = United States

b. Predictors: (Constant), ln (Expected Growth in EPS), Payout ratio, Beta

c. Dependent Variable: PEG

d. Weighted Least Squares Regression - Weighted by Market

Coefficients^{a,b,c}

| Model | | Unstandardized Coefficients | | Standardized Coefficients | t | Sig. |
|-------|-----------------------------|-----------------------------|------------|---------------------------|---------|------|
| | | B | Std. Error | Beta | | |
| 1 | (Constant) | -.580 | .265 | | -2.187 | .029 |
| | Payout ratio | 1.848 | .109 | .420 | 16.980 | .000 |
| | Beta | -.675 | .106 | -.159 | -6.361 | .000 |
| | ln (Expected Growth in EPS) | -1.248 | .087 | -.348 | -14.427 | .000 |

a. Broad Group = United States

b. Dependent Variable: PEG

c. Weighted Least Squares Regression - Weighted by Market Cap (in US \$)

A

PE ratio regressions across markets – January 2016

186

| Region | Regression – January 2016 | R ² |
|-----------------------|--|----------------|
| US | PE = 8.76 + 75.24 g _{EPS} + 19.73 Payout – 4.08 Beta | 40.5% |
| Europe | PE = 13.43 + 54.46 g _{EPS} + 17.63 Payout - 4.16 Beta | 24.7% |
| Japan | PE = 20.10+ 26.46 g _{EPS} + 24.87 Payout – 7.60 Beta | 28.4% |
| Emerging Markets | PE = 15.13 + 40.99 g _{EPS} + 9.03 Payout - 2.14 Beta | 11.5% |
| Australia, NZ, Canada | PE = 7.31 + 73.42 g _{EPS} + 13.94 Payout – 3.73 Beta | 26.8% |
| Global | PE = 12.51 + 87.48 g _{EPS} + 11.48 Payout - 3.96 Beta | 27.5% |

g_{EPS} = Expected Growth: Expected growth in EPS or Net Income: Next 5 years

Beta: Regression or Bottom up Beta

Payout ratio: Dividends/ Net income from most recent year. Set to zero, if net income < 0

Choosing Between the Multiples

- As presented in this section, there are dozens of multiples that can be potentially used to value an individual firm.
- In addition, relative valuation can be relative to a sector (or comparable firms) or to the entire market (using the regressions, for instance)
- Since there can be only one final estimate of value, there are three choices at this stage:
 - Use a simple average of the valuations obtained using a number of different multiples
 - Use a weighted average of the valuations obtained using a number of different multiples
 - Choose one of the multiples and base your valuation on that multiple

Picking one Multiple

- This is usually the best way to approach this issue. While a range of values can be obtained from a number of multiples, the “best estimate” value is obtained using one multiple.
- The multiple that is used can be chosen in one of two ways:
 - Use the multiple that best fits your objective. Thus, if you want the company to be undervalued, you pick the multiple that yields the highest value.
 - Use the multiple that has the highest R-squared in the sector when regressed against fundamentals. Thus, if you have tried PE, PBV, PS, etc. and run regressions of these multiples against fundamentals, use the multiple that works best at explaining differences across firms in that sector.
 - Use the multiple that seems to make the most sense for that sector, given how value is measured and created.

Conventional usage...

| Sector | Multiple Used | Rationale |
|------------------------------|---|---|
| Cyclical Manufacturing | PE, Relative PE | Often with normalized earnings |
| Growth firms | PEG ratio | Big differences in growth rates |
| Young growth firms w/ losses | Revenue Multiples | What choice do you have? |
| Infrastructure | EV/EBITDA | Early losses, big DA |
| REIT | P/CFE (where CFE = Net income + Depreciation) | Big depreciation charges on real estate |
| Financial Services | Price/ Book equity | Marked to market? |
| Retailing | Revenue multiples | Margins equalize sooner or later |

A closing thought...

