

Slides: <https://pages.stern.nyu.edu/~adamodar/pdfiles/country/val2day.pdf>

Webpage: <https://pages.stern.nyu.edu/~adamodar//New Home Page/valseminar.html>

VALUATION: IT'S NOT THAT COMPLICATED!

Aswath Damodaran

www.damodaran.com



THE BIG PICTURE

Just because you have a D and a CF does not mean you have a DCF!

Aswath Damodaran

SOME INITIAL THOUGHTS

- " One hundred thousand lemmings cannot be wrong"

Graffiti

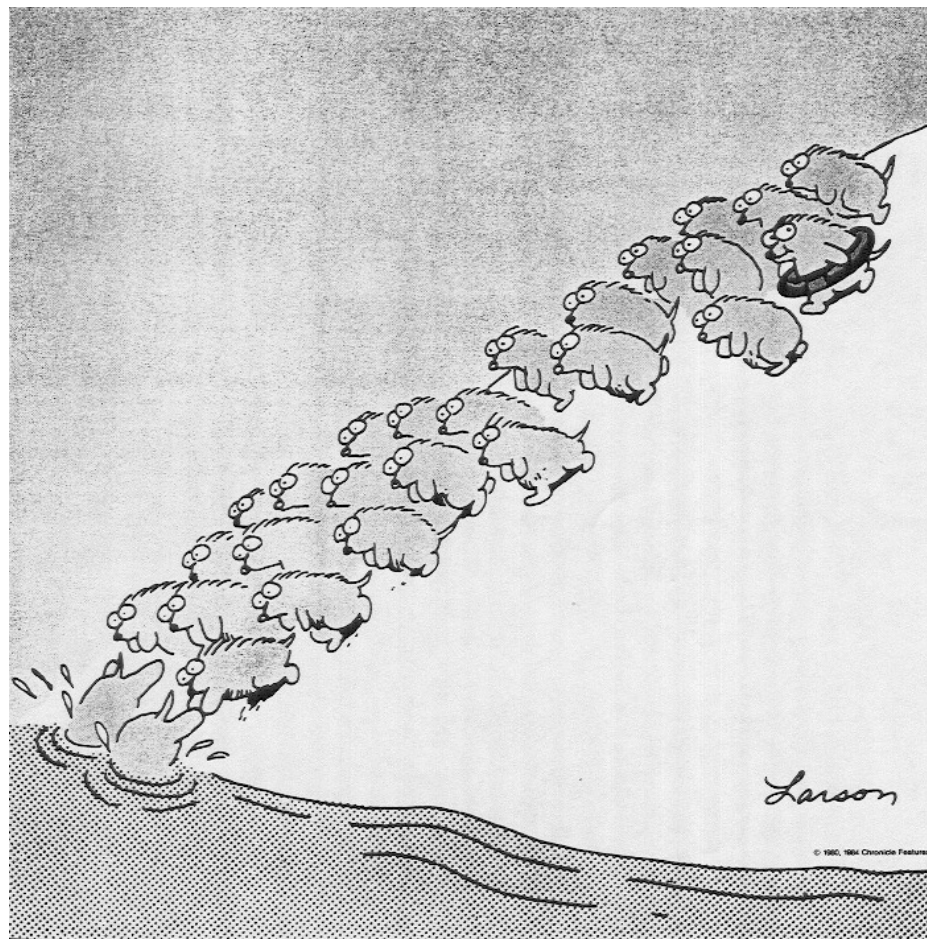

THEME 1: CHARACTERIZING VALUATION AS A DISCIPLINE

- In a **science**, if you get the inputs right, you should get the output right. The laws of physics and mathematics are universal and there are no exceptions. Valuation is not a science.
- In **art**, there are elements that can be taught but there is also a magic that you either have or you do not. The essence of an art is that you are either a great artist or you are not. Valuation is not an art.
- A **craft** is a skill that you learn by doing. The more you do it, the better you get at it. Valuation is a craft.

THEME 2: VALUING AN ASSET IS NOT THE SAME AS PRICING THAT ASSET

- Drivers of intrinsic value
- Cashflows from existing assets
 - Growth in cash flows
 - Quality of Growth

- Drivers of price
- Market moods & momentum
 - Surface stories about fundamentals

Accounting Estimates

Valuation Estimates

INTRINSIC VALUE

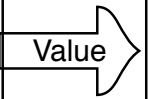

THE GAP
Is there one?
If so, will it close?
If it will close, what will cause it to close?

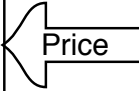

PRICE

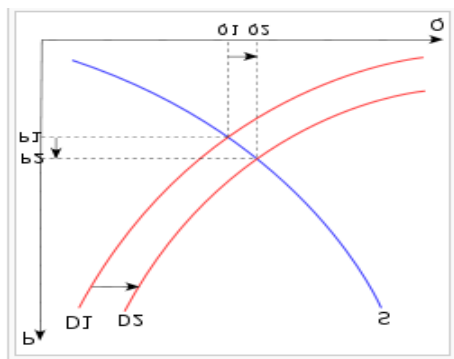

THEME 3: GOOD VALUATION = STORY + NUMBERS

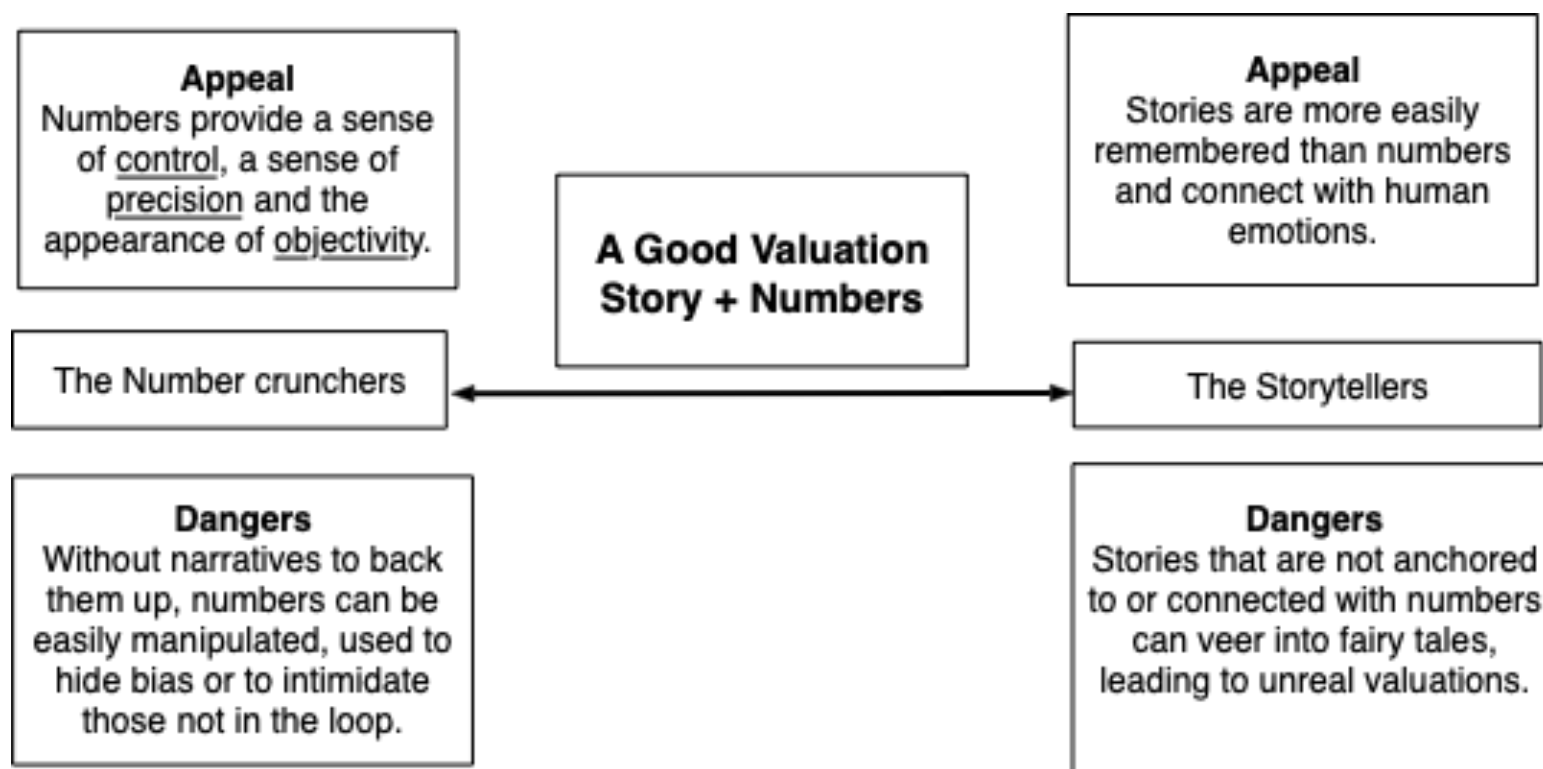

THEME 4: IF YOU VALUE SOMETHING, YOU SHOULD BE WILLING TO ACT ON IT..

- **What theory?** There is very little theory in valuation and I am not sure what an academic valuation would like like and am not sure that I want to find out.
- **Pragmatism, not purity:** The end game is to estimate a value for an asset. I plan to get there, even if it means taking short cuts and making assumptions that would make purists blanch.
- **Do you have faith?** To act on your valuations, you have to have faith in
 - In your own valuation judgments.
 - In markets: that prices will move towards your value estimates.
 - That faith will have to be earned.

MISCONCEPTIONS ABOUT VALUATION

- **Myth 1: A valuation is an objective search for “true” value**
 - Truth 1.1: All valuations are biased. The only questions are how much and in which direction.
 - Truth 1.2: The direction and magnitude of the bias in your valuation is directly proportional to who pays you and how much you are paid.
- **Myth 2.: A good valuation provides a precise estimate of value**
 - Truth 2.1: There are no precise valuations
 - Truth 2.2: The payoff to valuation is greatest when valuation is least precise.
- **Myth 3: . The more quantitative a model, the better the valuation**
 - Truth 3.1: One’s understanding of a valuation model is inversely proportional to the number of inputs required for the model.
 - Truth 3.2: Simpler valuation models do much better than complex ones.

APPROACHES TO VALUATION

- **Intrinsic valuation**, relates the value of an asset to the present value of expected future cashflows on that asset. In its most common form, this takes the form of a discounted cash flow valuation.
- **Relative valuation or Pricing**, estimates the value of an asset by looking at the pricing of 'comparable' assets relative to a common variable like earnings, cash flows, book value or sales.
- **Contingent claim valuation**, uses option pricing models to measure the value of assets that share option characteristics.



INTRINSIC VALUATION: THE BIG PICTURE

Putting the Pieces in Perspective!

Aswath Damodaran

DISCOUNTED CASH FLOW VALUATION

- **What is it:** In discounted cash flow valuation, the value of an asset is the present value of the expected cash flows on the asset.
- **Philosophical Basis:** Every asset has an intrinsic value that can be estimated, based upon its characteristics in terms of cash flows, growth and risk.
- **Information Needed:** To use discounted cash flow valuation, you need
 - to estimate the life of the asset
 - to estimate the cash flows during the life of the asset
 - to estimate the discount rate to apply to these cash flows to get present value
- **Market Inefficiency:** Markets are assumed to make mistakes in pricing assets across time, and are assumed to correct themselves over time, as new information comes out about assets.

RISK ADJUSTED VALUE: THREE BASIC PROPOSITIONS

- The value of a risky asset can be estimated by discounting the expected cash flows on the asset over its life at a risk-adjusted discount rate:

$$\text{Value of asset} = \frac{E(CF_1)}{(1+r)} + \frac{E(CF_2)}{(1+r)^2} + \frac{E(CF_3)}{(1+r)^3} \dots + \frac{E(CF_n)}{(1+r)^n}$$

- **The IT Proposition:** If “it” does not affect the cash flows or alter risk (thus changing discount rates), “it” cannot affect value.
- **The DUH Proposition:** For an asset to have value, the expected cash flows have to be positive some time over the life of the asset.
- **The DON'T FREAK OUT Proposition:** Assets that generate cash flows early in their life will be worth more than assets that generate cash flows later; the latter may however have greater growth and higher cash flows to compensate.

DCF CHOICES: EQUITY VALUATION VERSUS FIRM VALUATION

Firm Valuation: Value the entire business

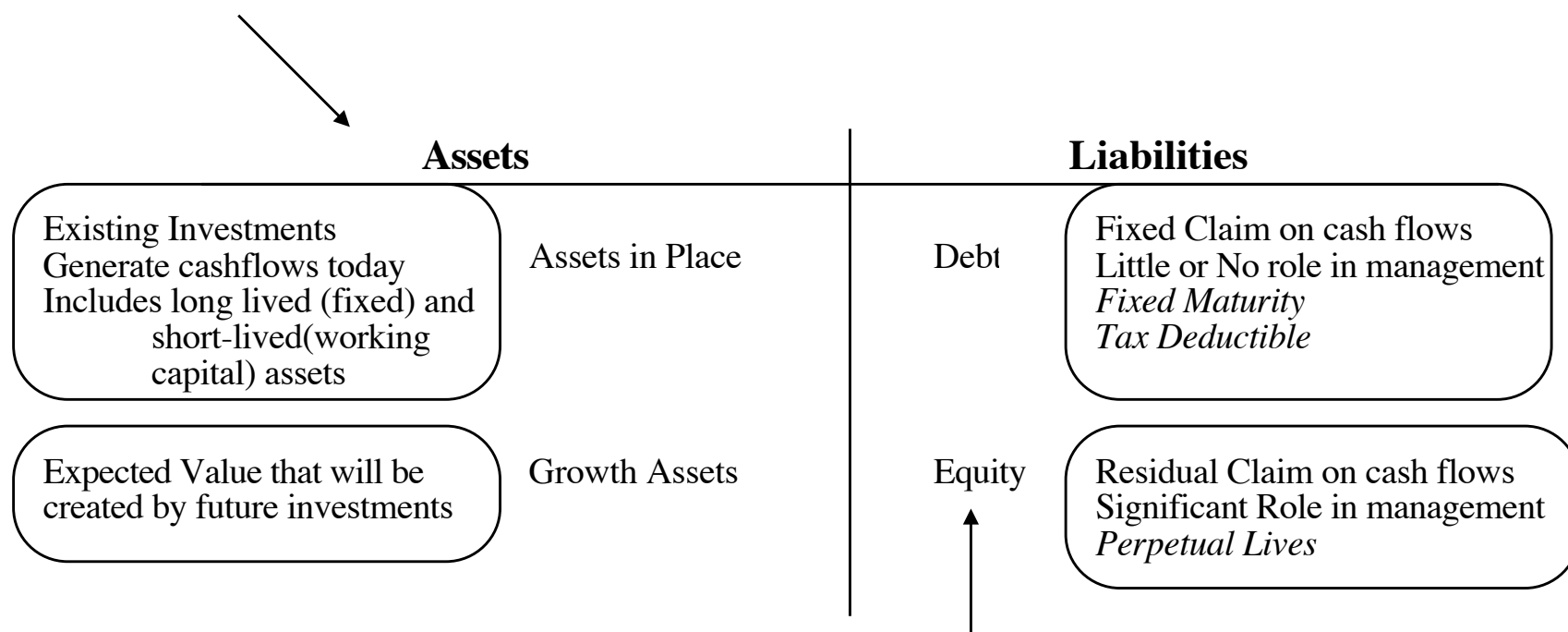

Equity valuation: Value just the equity claim in the business

THE DRIVERS OF VALUE...

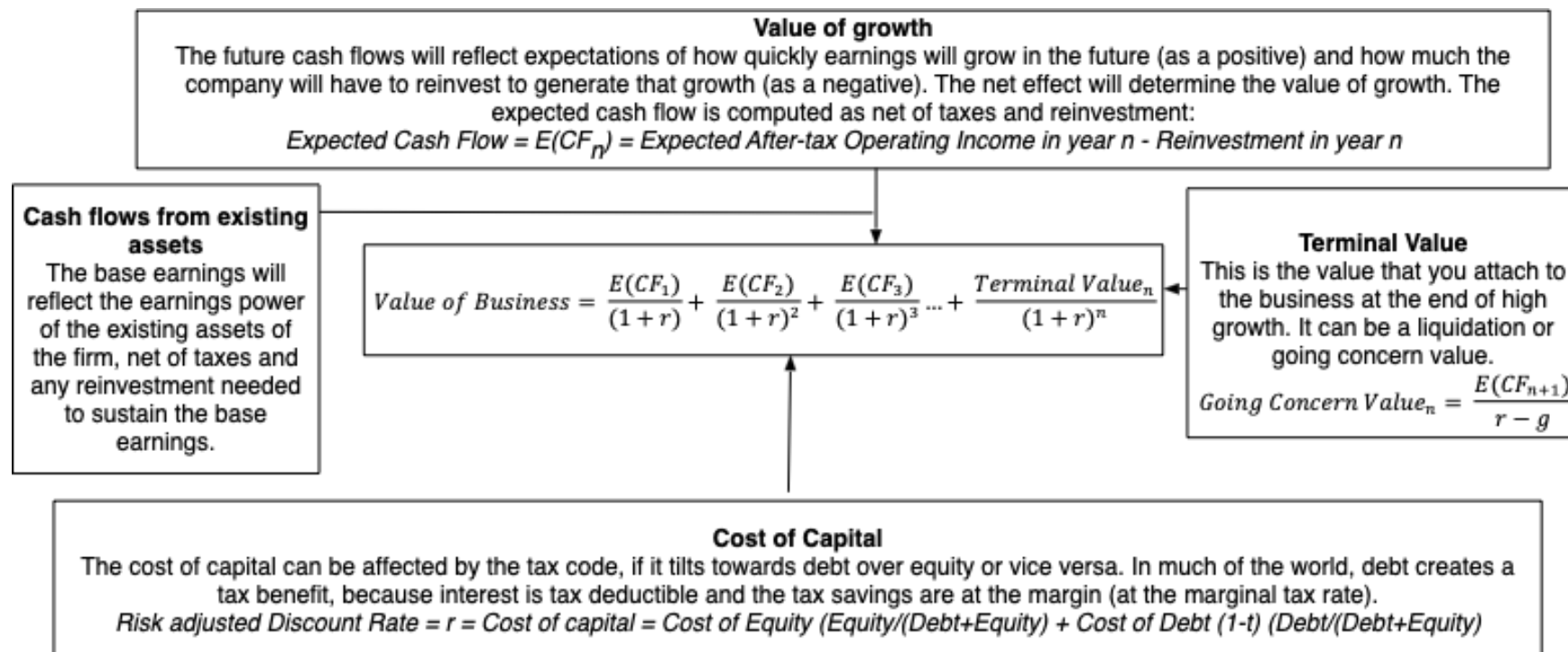

Going Concern Val

Start with the past

Cash flow to Firm

Revenues * Operating Margin
= Operating Income

* (1- tax rate) Tax Effect

- (Cap Ex - Depreciation) Reinvestment

- Change in non-cash WC

= Free Cash flow to Firm

- * How quickly is the firm growing?
- * How efficiently is it growing?
- * How profitable is the firm?

Forecast future cashflows

If margins & returns are stable

Expected growth in operating income = Reinvestment Rate * Return on Invested Capital

FCFF = After-tax Oper. Income (1 - Reinvestment Rate)

If margins & returns are changing

1. Estimate revenue growth & future revenues

2. Estimate operating margins over time

3. Estimate reinvestment based on revenues

FCFF = After tax Operating Income - Reinvestment

Apply Closure

Firm is mature

Cashflow/Earnings grow at constant rate forever (g_n)

Terminal Value = $FCFF_{n+1} / (r - g_n)$

Value of Operating Assets
+ Cash
+ Non-operating Assets
- Debt
= Value of Equity

Adjust for risk of failure
= Probability of failure * Value of Equity in failure

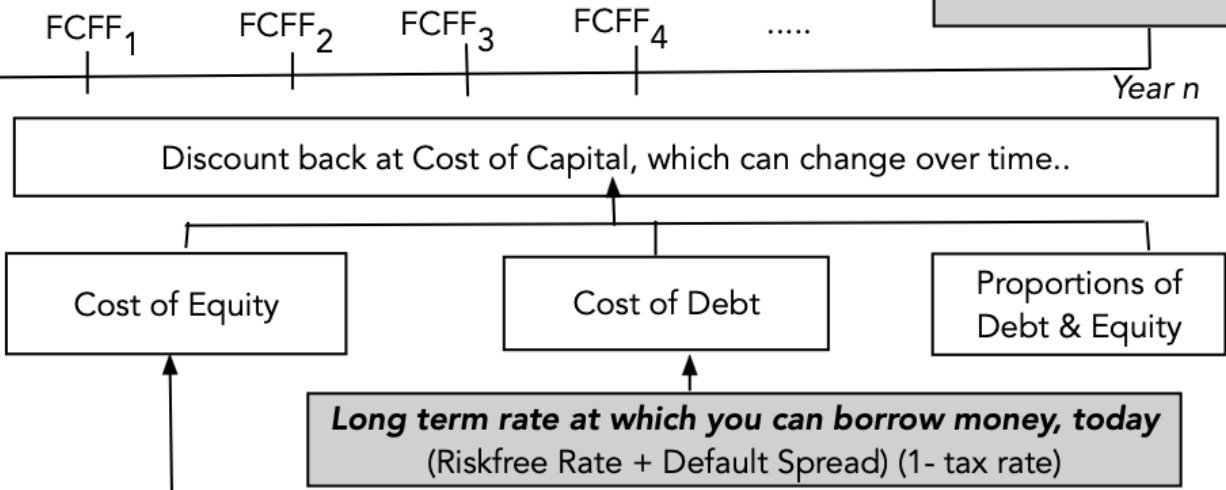

Return required by "marginal" investors, given perceived risk in equity investment

Riskfree Rate

- Default free & long term
- In same currency and in same terms as cash flows

+

Relative Risk Measure (Beta)

Business Mix

Financial Leverage

X

Equity Risk Premium

Operating Locations

Aswath Damodaran

Adjust for operating risk in cashflows

Net Cap Ex = Acctg Cap Ex (255) + Cap R&D (2216) + Acquisitions (\$3,975)

Amgen: A Status Quo Valuation - May 1, 2007

Amgen will continue with existing management practices in place on reinvestment (a mix of R&D and acquisitions), while delivering stable operating margins.

Current Cash Flows (\$ m)
 EBIT: (1-t): \$6,058
 - Net Cap Ex: \$6,443
 - Chg WC: \$ 37
FCFF: -\$423

Reinvestment Rate
 = $(6443+37)/6058 = 106.98\%$
 ROIC = $\$6,058/\$36254 = 16.71\%$
 Effective tax rate = 28%

For the next five years

Reinvestment Rate
 = 60% (Average over last 5 years)

Expected ROIC
 = 16% (trend down over time)

Expected Growth rate next 5 years
 = $.6 \times 16 = .096$ or 9.6%

Transition period (years 6-10)

- Growth goes from 9.6% to 4%
- ROIC drifts down to 10%
- Reinvestment rate decreases over time

Beyond year 10

Stable growth rate = 4%
 ROIC = 10%; Tax rate = 35%
 Reinvestment Rate = $4/10 = 40\%$

Terminal Value = $\$7300 / (.0808 - .04) = \$179,099$

FCFF in year 11
 EBIT (1-t): \$12,167
 - Reinvestment \$4,867
 = FCFF \$7,300

PV of FCFF (Yrs 1-10) =	\$25,460.54
+ PV of Terminal Value =	\$68,753.78
Value of operating assets of the firm =	\$94,214.31
+ Cash	\$1,283.00
Value of Firm =	\$95,497.31
- Debt	\$8,271.52
Value of Equity =	\$87,225.79
- Employee Option Value	\$478.68
Value of Equity in Common Stock =	\$86,747.11
Value/Share	\$74.33

	1	2	3	4	5	6	7	8	9	10
EBIT Growth	9.60%	9.60%	9.60%	9.60%	9.60%	8.48%	7.36%	6.24%	5.12%	4.00%
EBIT (1-t)	\$6,639	\$7,276	\$7,975	\$8,741	\$9,580	\$10,392	\$11,157	\$11,853	\$12,460	\$12,958
Reinvestment Rate	60.00%	60.00%	60.00%	60.00%	60.00%	56.00%	52.00%	48.00%	44.00%	40.00%
- Reinvestment	\$3,983	\$4,366	\$4,785	\$5,244	\$5,748	\$5,820	\$5,802	\$5,690	\$5,482	\$5,183
= FCFF	\$2,656	\$2,911	\$3,190	\$3,496	\$3,832	\$4,573	\$5,355	\$6,164	\$6,978	\$7,775
Cost of Capital	10.90%	10.90%	10.90%	10.90%	10.90%	10.33%	9.77%	9.21%	8.64%	8.08%
Cumulated WACC	1.1090	1.2299	1.3639	1.5126	1.6774	1.8508	2.0316	2.2186	2.4103	2.6049
PV of FCFF	\$2,395	\$2,367	\$2,339	\$2,311	\$2,284	\$2,471	\$2,636	\$2,778	\$2,895	\$2,985

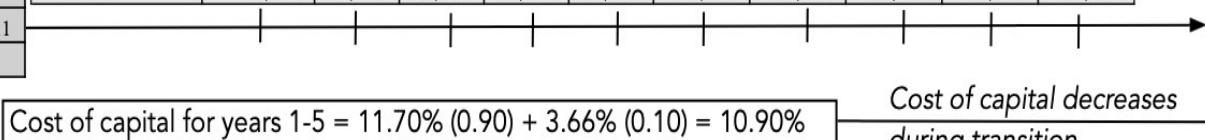

Amgen Price (5/1/07) = \$55

Cost of equity = $4.78\% + 1.73 (4\%) = 11.70\%$

Riskfree Rate in US\$ = 4.78%

Beta = 1.73

Beta for Pharma = 1.59

Amgen D/E = 11.06%

Equity Risk Premium = 4%

All revenues in US

Cost of debt = $5.63\% (1-.35) = 3.66\%$

Riskfree Rate in US\$ = 4.78%

Default Spread based on rating = 0.85%

Marginal Tax rate = 35%

Beta = 1.10
 Cost of equity = $4.78\% + 1.10 (4\%) = 9.18\%$
 Debt ratio = 20%
 Cost of capital = $9.18\% (.8) + 3.66\% (.2) = 8.08\%$

Tata Motors: A Family Group Company in Transition - April 2010

Tata Motor's acquisition of Jaguar Land Rover changes the company, and gives it a global, luxury car twist to a mass market auto company.

Acquisitions are cap ex

A big portion of net cap ex in 2009 came up the JLR acquisition

Current Cash Flows (Rs mil)

EBIT: (1-t): Rs 20,116
 - Net Cap Ex: Rs 31,590
 - Chg WC: Rs 2,732
FCFF: Rs-14,206

Reinvestment Rate
 = $(31590+2732)/20116 = 170.61\%$
 ROIC = $20116/117226 = 17.16\%$
 Effective tax rate = 21%

For the next five years

Reinvestment Rate = 70% (Average without acquisition)
 Expected ROIC = 17.16% (current value)

Expected Growth rate next 5 years
 = $.7 * 17.16 = .1201$ or 12.01%

Transition period (years 6-10)

- Growth goes from 12.01% to 5%
 - ROIC drifts down to 10.11%
 - Reinvestment rate decreases over time

Beyond year 10

Stable growth rate = 5%
 ROIC = 10.11%; Tax rate = 33.99%
 Reinvestment Rate = $5\%/10.11\% = 49.45\%$

Terminal Value = Rs 22,890/
 $(.1011-.05) = Rs 447,750$

PV of FCFF (Yrs 1-10) =	₹ 66,691
+ PV of Terminal Value =	₹ 142,148
Value of operating assets of	₹ 208,839
+ Cash	₹ 11,418
+ Cross holdings	₹ 140,576
Value of Firm =	₹ 360,833
-Debt	₹ 109,198
Value of Equity =	₹ 251,635
Value per share	₹ 609.21

Year	1	2	3	4	5	6	7	8	9	10
EBIT Growth	12.01%	12.01%	12.01%	12.01%	12.01%	10.61%	9.21%	7.80%	6.40%	5.00%
EBIT (1-t)	₹ 22,533	₹ 25,240	₹ 28,272	₹ 31,668	₹ 35,472	₹ 39,236	₹ 42,848	₹ 46,192	₹ 49,150	₹ 51,607
Reinvestment Rate	70.00%	70.00%	70.00%	70.00%	70.00%	65.89%	61.78%	57.67%	53.56%	49.44%
- Reinvestment	₹ 15,773	₹ 17,668	₹ 19,790	₹ 22,168	₹ 24,830	₹ 25,852	₹ 26,471	₹ 26,638	₹ 26,323	₹ 25,517
FCFF	₹ 6,760	₹ 7,572	₹ 8,482	₹ 9,500	₹ 10,642	₹ 13,384	₹ 16,377	₹ 19,555	₹ 22,827	₹ 26,090
Cost of capital	13.04%	13.04%	13.04%	13.04%	13.04%	12.46%	11.87%	11.28%	10.70%	10.11%
Cumulated WACC	1.1304	1.2778	1.4445	1.6329	1.8458	2.0757	2.3221	2.5841	2.8606	3.1499
PV of FCFF	₹ 5,980	₹ 5,926	₹ 5,872	₹ 5,818	₹ 5,765	₹ 6,448	₹ 7,053	₹ 7,567	₹ 7,980	₹ 8,283

FCFF in year 11
 EBIT (1-t): Rs 45,278
 - Reinvestment Rs 22,387
 = FCFF Rs 22,890

Tata Motors Price = Rs 780.50

Cost of capital for years 1-5 = $14.72\% (0.747) + 8.09\% (0.253) = 13.04\%$

Debt weight: Equity = 74.7% and Debt = 25.3%

Cost of capital decreases during transition

Beta = 1.20
 Cost of equity = $5.00\% + 1.20 (6.90\%) = 11.90\%$
 Debt ratio = 30%
 Cost of debt = 9%
 Cost of capital = $11.90\% (.8) + 9\% (1-.3399) (.3) = 10.11\%$

Cost of equity = $5.00\% + 1.20 (8.10\%) = 14.72\%$

Riskfree Rate in Rs = 5.00%

Beta = 1.20

ERP = $4.50\% (.2) + 9.00\% (.8) = 8.10\%$

Beta for Auto = 0.98

TM D/E = 33.87%

20% in mature mkt
 80% in India

Cost of debt = $(5\%+3\%+4.25\%) (1-.3399) = 8.09\%$

Riskfree Rate in Rs = 5.00%

+ Default Spread for country = 3.00%

+ Default Spread for company = 4.25%

Marginal Tax rate = 33.99%

Enka has a history of strong growth and high margins, but it got a boost from Russian business in 2021 & 2022. Over time, Enka has also become more capital intensive as a company.

Enka: My valuation (February 2025)

	LTM	Last 5 years	Global Industry Avg
Revenue Growth	23.52%	52.96%	6.78%
Operating Margin	22.61%	23.48%	4.81%
Sales to Capital	0.57	0.96	2.12
Return on Capital	10.90%	17.74%	7.78%

Revenue growth 22% next five years, tapering down to 15% in year 10

Pre-tax operating margin settles in at 22.5% over time, Enka's 10-year average

Sales to capital ratio of 1.5, higher than the past, but lower than the industry.

Stable Growth
 $g = 15.0\%$
 Cost of capital = 20%
 ROC = 25%;
 Reinvestment Rate = $15\%/25\% = 60\%$

Terminal Value = $42,742 / (.20 - .15) = TL 854,837$

PV(Terminal value)	₺91,891
PV (CF over next 10 years)	₺39,078
Value of operating assets =	₺130,969.27
- Debt	₺4,032.70
- Minority interests	₺3,250.20
+ Cash	₺108,862.50
+ Non-operating assets	₺72,817.70
Value of equity	₺305,366.57
Number of shares	5839.50
Estimated value /share	₺52.29

	1	2	3	4	5	6	7	8	9	10
Revenue Growth	22.00%	22.00%	22.00%	22.00%	22.00%	20.60%	19.20%	17.80%	16.40%	15.00%
Revenue	₺109,646	₺133,768	₺163,197	₺199,101	₺242,903	₺292,941	₺349,185	₺411,340	₺478,800	₺550,620
Operating Margin	22.50%	22.50%	22.50%	22.50%	22.50%	22.50%	22.50%	22.50%	22.50%	22.50%
Operating Income	₺24,670	₺30,098	₺36,719	₺44,798	₺54,653	₺65,912	₺78,567	₺92,552	₺107,730	₺123,889
EBIT (1-t)	₺20,822	₺25,403	₺30,991	₺37,809	₺46,127	₺54,390	₺63,356	₺72,894	₺82,823	₺92,917
Reinvestment	₺16,081	₺19,619	₺23,936	₺29,201	₺33,359	₺37,496	₺41,437	₺44,973	₺47,880	₺55,062
FCFF	₺4,740	₺5,783	₺7,056	₺8,608	₺12,769	₺16,894	₺21,920	₺27,920	₺34,943	₺37,855

Cost of capital = $25.41\% (.993) + 17.34\% (.007) = 25.41\%$

1. Riskfree rate drops to 15% as inflation eases.
 2. Cost of capital drops to 20%.

On February 7, 2025, the shares were trading at 49.36 TL per share.

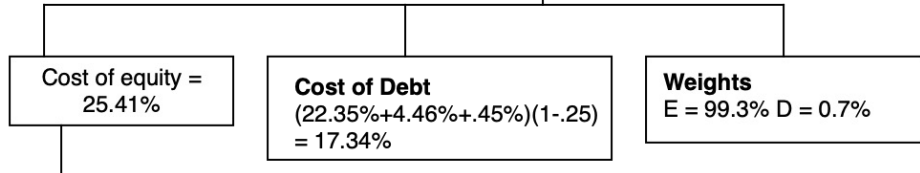

Riskfree Rate: In Turkish Lira = 22.35%

+ **Beta** 0.55 x **Risk Premium** 8.84%

D/E = 0.7%

Business	Revenues	EV/Sales	Estimated Value	Weights	Unlevered Beta
Engineering/Construction	\$ 48,553.00	0.6929	\$ 33,644.19	32.47%	0.6631
Real Estate (General/Diversified)	\$ 7,094.00	3.4523	\$ 24,490.91	23.63%	0.5278
Transportation	\$ 6,575.00	1.2300	\$ 8,087.03	7.80%	0.7080
Power	\$ 16,679.00	2.2428	\$ 37,407.71	36.10%	0.4266
Company	\$ 78,901.00		\$ 103,629.85		0.5493

Country	Revenues	ERP	Weight	Weighted ER
Turkey	₺41,194	10.34%	51.82%	5.36%
Russia	₺22,997	8.35%	28.93%	2.41%
Europe	₺9,832	5.45%	12.37%	0.67%
Rest of the	₺5,478	5.76%	6.89%	0.40%
Total	₺79,501		100.00%	8.84%

LVMH													Jan-25	
Base Year and Comparison			Growth Story			Profitability Story			Growth Efficiency Story			Terminal Value		
	Company	Industry	Growth from Asia, will keep growth rates slightly above mature levels.			Margins will increase slightly, but level off, as company pursues growth in Asia.			Maintained at global industry average			Growth Rate	2.63%	
Revenue Growth	-1.30%	5.54%										Cost of capital	6.96%	
Revenue	\$85,590											Return on capital	12.00%	
Operating Margin	25.55%	5.89%										Reinvestment Rate	21.92%	
Operating Income	\$21,871													
EBIT (1-t)	\$16,010													
PV(Terminal value)	\$ 245,569		1	2	3	4	5	6	7	8	9	10	Terminal year	
PV (CF over next 10 years)	\$ 137,161		Revenue Growth	5.00%	5.00%	5.00%	5.00%	5.00%	4.53%	4.05%	3.58%	3.10%	2.63%	2.63%
Probability of failure =	0.00%		Revenue	\$ 89,870	\$ 94,363	\$ 99,081	\$ 104,035	\$ 109,237	\$ 114,181	\$ 118,808	\$ 123,059	\$ 126,878	\$ 130,215	\$ 133,640
Value of operating assets =	\$382,730		Operating Margin	25.55%	25.73%	25.82%	25.91%	26.00%	26.00%	26.00%	26.00%	26.00%	26.00%	26.00%
- Debt	\$40,851		Operating Income	\$ 22,965	\$ 24,281	\$ 25,584	\$ 26,956	\$ 28,402	\$ 29,687	\$ 30,890	\$ 31,995	\$ 32,988	\$ 33,856	\$ 34,746
- Minority interests	\$1,675		EBIT (1-t)	\$ 16,810	\$ 17,774	\$ 18,728	\$ 19,732	\$ 20,790	\$ 21,838	\$ 22,834	\$ 23,766	\$ 24,623	\$ 25,392	\$ 26,060
+ Cash	\$11,097		Reinvestment	\$ 1,519	\$ 1,595	\$ 1,675	\$ 1,758	\$ 1,671	\$ 1,564	\$ 1,437	\$ 1,291	\$ 1,128	\$ 1,158	\$ 5,711
+ Non-operating assets	\$2,534		FCFF	\$ 15,291	\$ 16,179	\$ 17,053	\$ 17,974	\$ 19,119	\$ 20,274	\$ 21,397	\$ 22,475	\$ 23,495	\$ 24,234	\$ 20,348
Value of equity	\$353,835												\$ 469,938.51	
- Value of options	\$0													
Value of equity in common stock	\$353,835		Cost of Capital	6.60%	6.60%	6.60%	6.60%	6.60%	6.67%	6.74%	6.81%	6.89%	6.96%	
Number of shares	502.12		Cumulated WACC	0.9381	0.8801	0.8256	0.7745	0.7266	0.6812	0.6381	0.5974	0.5589	0.5226	
Estimated value /share	\$704.68													
			Sales to Capital	2.96	2.96	2.96	2.96	2.96	2.96	2.96	2.96	2.96	2.96	
Price per share	\$651.00		ROIC	17.78%	18.50%	19.17%	19.86%	20.56%	21.25%	21.88%	22.47%	23.00%	23.47%	12.00%
% Under or Over Valued	-7.62%													
			Risk Story			Competitive Advantages								
			Cost of capital is low, with no failure risk, moving close to median company over time.			Strong competitive edges sustainable for the long term								



INTRINSIC VALUE: NUTS AND BOLTS!

The details matter, but never as much as you think they do...

I. MEASURE EARNINGS RIGHT..

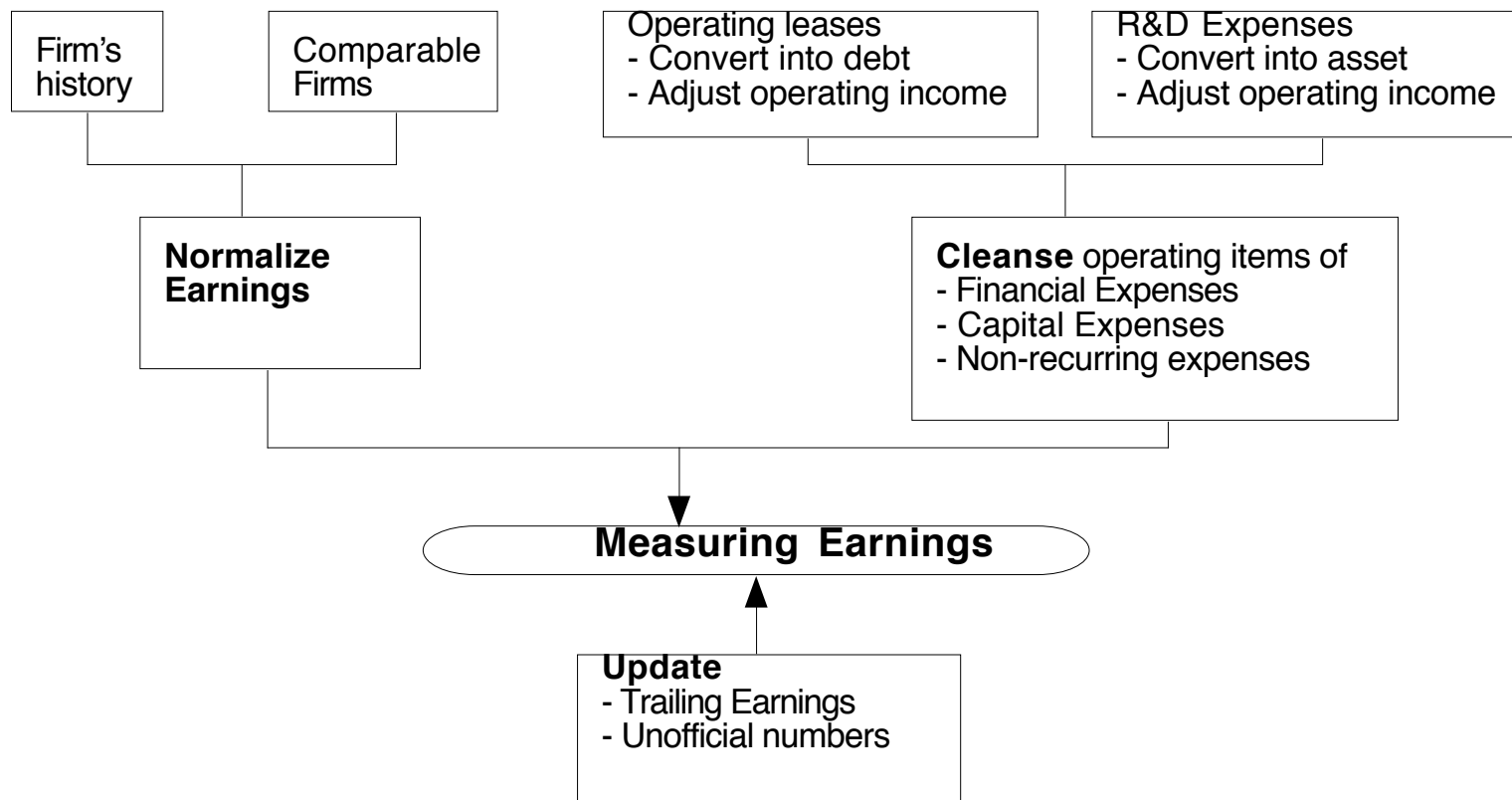

OPERATING LEASES AT AMGEN IN 2007

- Amgen has lease commitments and its cost of debt is 5.63%.

Year	Commitment	Present Value
1	\$96.00	\$90.88
2	\$95.00	\$85.14
3	\$102.00	\$86.54
4	\$98.00	\$78.72
5	\$87.00	\$66.16
6-12	\$107.43	\$462.10 (\$752 million prorated)

- Debt Value of leases = **\$869.55**
- Debt outstanding at Amgen = \$7,402 + \$ 870 = \$8,272 million
- **Adjusted Operating Income**
= Stated OI + Lease expense this year – Depreciation
= 5,071 m + 69 m - 870/12 = \$5,068 million (12-year life for assets)

CAPITALIZING R&D EXPENSES: AMGEN

- R & D was assumed to have a 10-year life.

<i>Year</i>	<i>R&D Expense</i>		<i>Unamortized portion</i>	<i>Amortization this year</i>
Current	3366.00	1.00	3366.00	
-1	2314.00	0.90	2082.60	\$231.40
-2	2028.00	0.80	1622.40	\$202.80
-3	1655.00	0.70	1158.50	\$165.50
-4	1117.00	0.60	670.20	\$111.70
-5	865.00	0.50	432.50	\$86.50
-6	845.00	0.40	338.00	\$84.50
-7	823.00	0.30	246.90	\$82.30
-8	663.00	0.20	132.60	\$66.30
-9	631.00	0.10	63.10	\$63.10
-10	558.00		0.00	\$55.80
			\$10,113	\$1,150

- Value of Research Asset & Current Amortization = **\$10,113**
- Adjusted Operating Income = \$5,120 + 3,366 - 1,150 = \$7,336 million

DECONSTRUCTING AN INCOME STATEMENT...

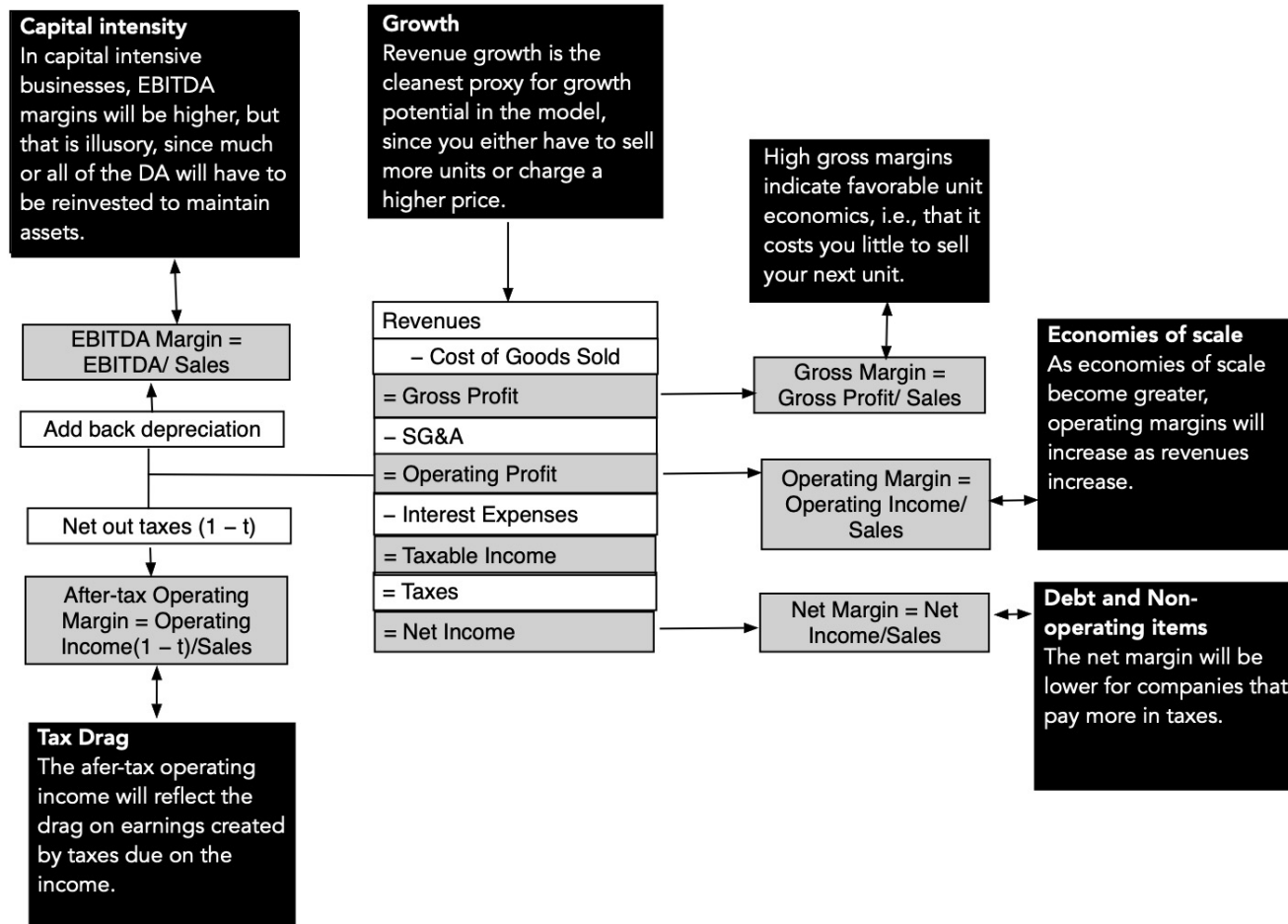

LVMH'S OPERATING HISTORY

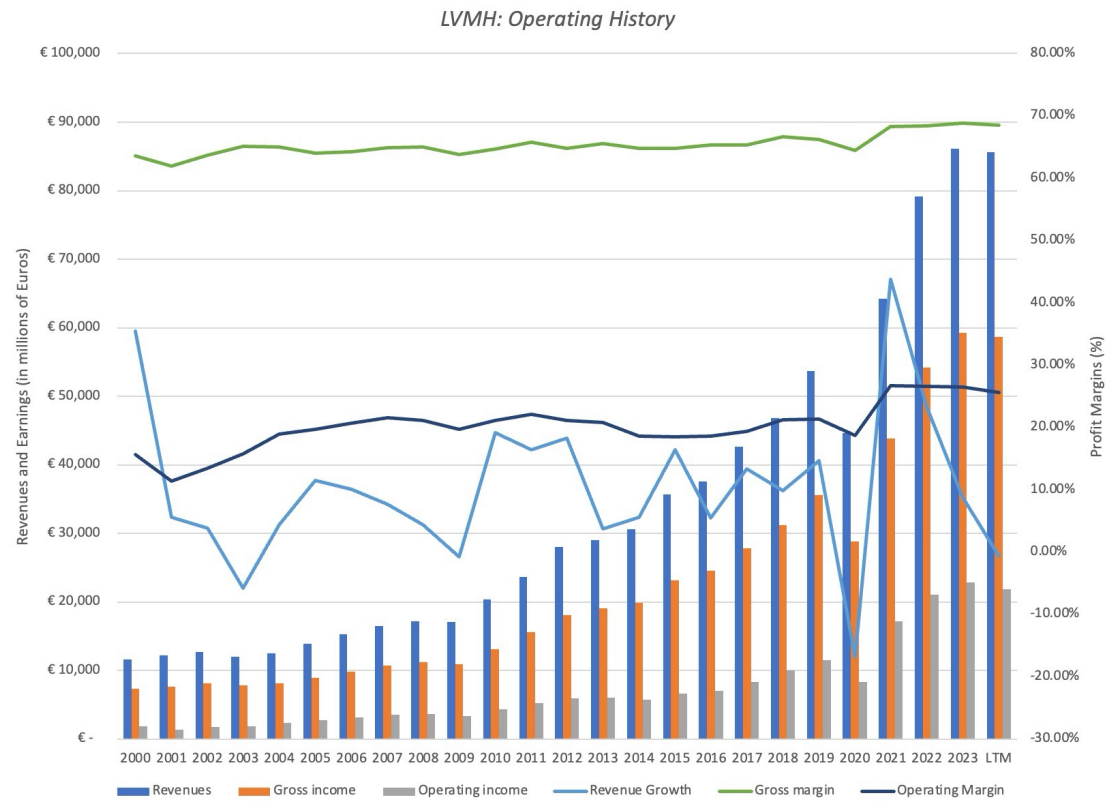

Period	Revenue Growth	Gross Margin	Operating Margin
2001-2010	5.78%	64.24%	18.32%
2011-2020	8.19%	65.36%	20.04%
2021-2024	12.38%	67.71%	24.79%

AND ENKA'S HISTORY

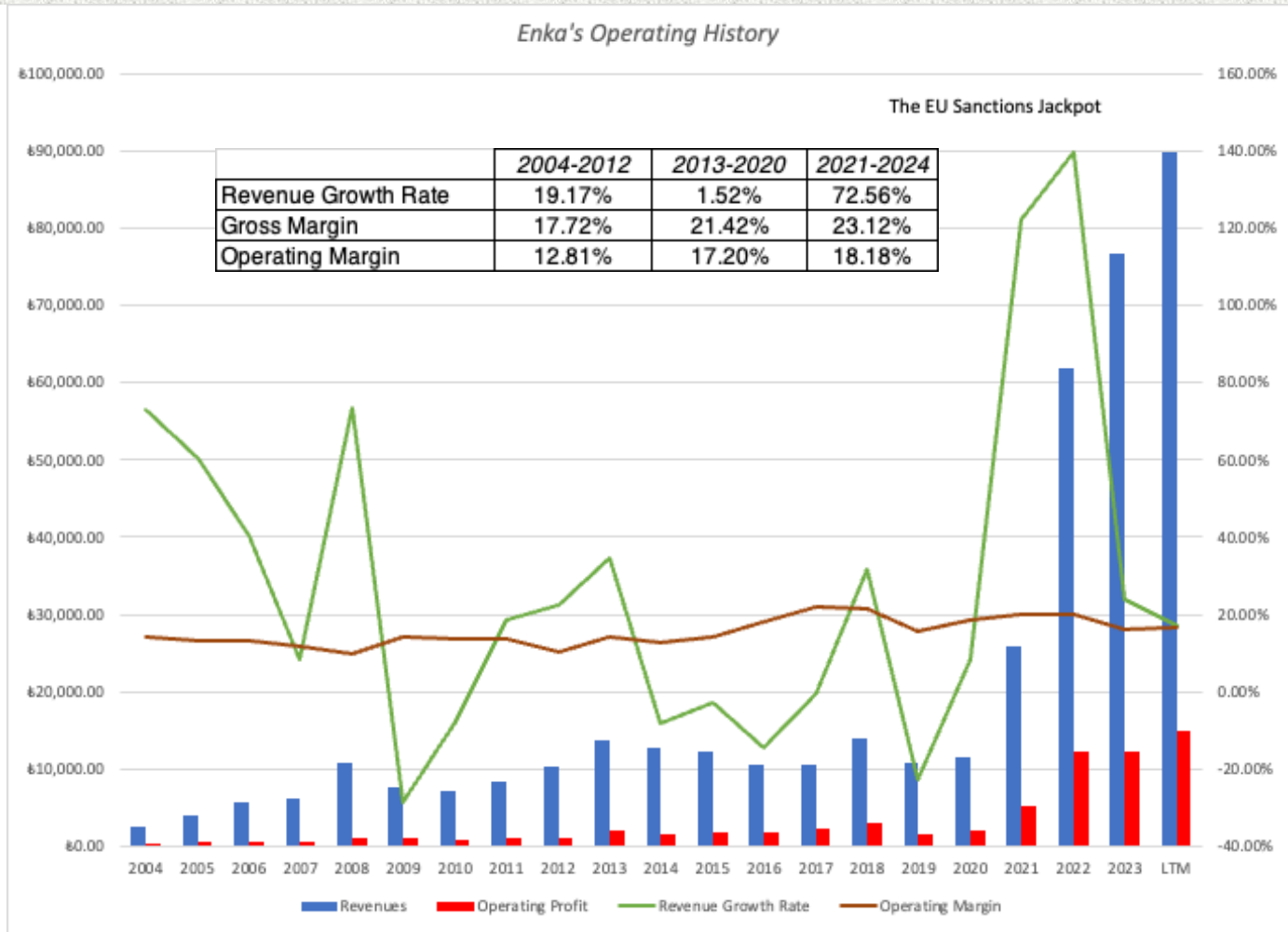

II. GET THE BIG PICTURE (NOT THE ACCOUNTING ONE) WHEN IT COMES TO CAP EX AND WORKING CAPITAL

- Capital expenditures should include
 - **Research and development expenses**, once they have been re-categorized as capital expenses.
 - **Acquisitions of other firms**, whether paid for with cash or stock.
- Working capital should be defined not as the difference between current assets and current liabilities but as the difference between **non-cash current assets and non-debt current liabilities**.
- On both items, start with what the company did in the most recent year but do look at the company's history and at industry averages.

AMGEN'S NET CAPITAL EXPENDITURES

- The accounting net cap ex at Amgen is small:
 - Accounting Capital Expenditures = \$1,218 million
 - - Accounting Depreciation = \$ 963 million
 - Accounting Net Cap Ex = \$ 255 million
- We define capital expenditures broadly to include R&D and acquisitions:
 - Accounting Net Cap Ex = \$ 255 million
 - Net R&D Cap Ex = (3366-1150) = \$2,216 million
 - Acquisitions in 2006 = \$3,975 million
 - Total Net Capital Expenditures = \$ 6,443 million
- Acquisitions have been a **volatile item**. Amgen was quiet on the acquisition front in 2004 and 2005 and had a significant acquisition in 2003.

III. THE GOVERNMENT BOND RATE IS NOT ALWAYS THE RISKFREE RATE

- When valuing Amgen in US dollars, the US\$ ten-year bond rate of 4.78% was used as the riskfree rate. **We assumed that the US treasury was default free.**
- When valuing Tata Motors in Indian rupees in 2010, the Indian government bond rate of 8% was not default free. Using the Indian government's **local currency rating of Ba2** yielded a default spread of 3% for India and a **riskfree rate of 5% in Indian rupees.**

Risk free rate in Indian Rupees in 2010 = 8% - 3% = 5%

- To value Enka in February 2025, you need a risk free rate in Turkish Lira. The Turkish Lira government bond rate on February 9, 2025 was 26.81%. The Turkish government **was rated B1** on that day with a default spread of 4.46% associated with it. The risk free rate in Turkish Lira is:
 - Risk free Rate in Lira = 26.81% - 4.46% = 22.35%

RISK FREE RATES WILL VARY ACROSS CURRENCIES!

Government-bond Based Riskfree Rates in January 2025

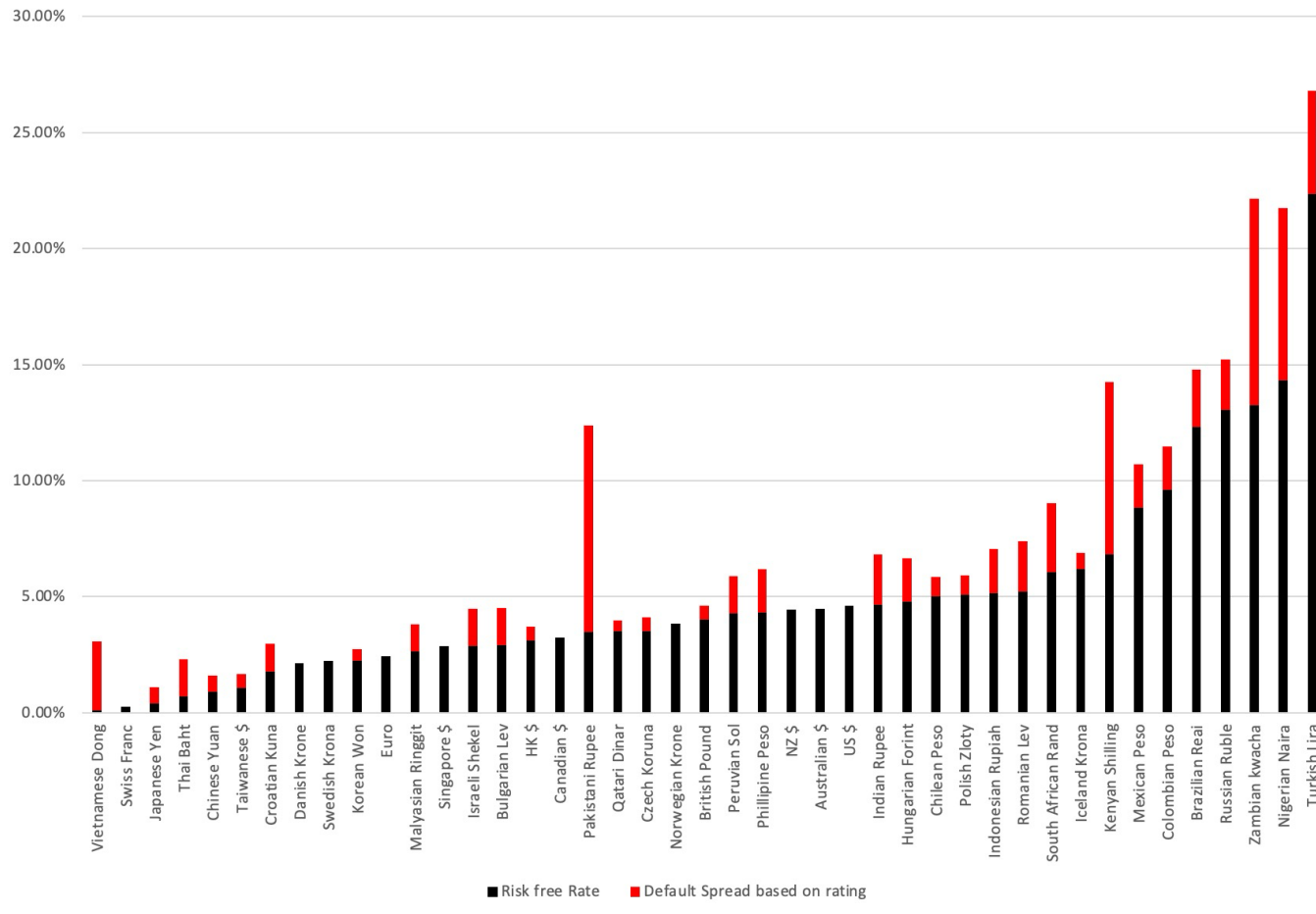

RISK FREE RATES IN CURRENCIES WITHOUT A GOVERNMENT BOND RATE OR ONE THAT YOU CAN TRUST

- **There are no traded long term Government bonds in some currencies.** Hence, you have to improvise. In other cases, you may find a government bond rate, but since the bond is seldom traded or the rate is artificially set, you cannot trust the rate.
- One simple technique is to **use differential inflation and the US dollar risk free rate.** Using this technique on the Egyptian pound, here is what you get:
 - Risk free rate in US dollars on 12/31/15 = 2.27%
 - Expected inflation rate in the US = 1.50%
 - Expected inflation rate in Egypt = 9.70% (last year's estimate)
 - Risk free rate in EGP = $(1.0227) * (1.097/1.015) - 1 = 10.53\%$
- This is also a **good way to check government bond rates that you do not trust.** For instance, if you believe that expected inflation in Vietnam (long term) is 4%, your riskfree rate would then be as follows (assuming a 4% riskfree rate in US dollars, with a 2.5% inflation rate):
 - Riskfree rate in Indian rupees = $1.04 (1.04/1.025) - 1 = 5.52\%$

BUT VALUATIONS SHOULD NOT! REVISITING THE TATA MOTORS VALUATION

	In Indian Rupees	In US \$
Risk free Rate	5.00%	2.00%
Expected inflation rate	4.00%	1.00%
Cost of capital		
- High Growth	12.50%	9.25%
- Stable Growth	10.39%	7.21%
Expected growth rate		
- High Growth	12.01%	8.78%
- Stable Growth	5.00%	2.00%
Return on Capital		
- High Growth	17.16%	13.78%
- Stable Growth	10.39%	7.21%
Value per share	Rs 614	\$12.79/share (roughly Rs 614 at current exchange rate)

Heineken: September 2019 (in Euros)

Cash flows from existing assets

	LTM	2013-2018
Revenues	€ 23,119	Growth rate = 3.22%
Operating Margin	14.86%	14.44%
Sales/Invested Capital	0.71	0.79
ROIC	7.46%	8.32%
Effective Tax Rate	29.70%	27.00%

The Payoff from growth

Revenues will grow 3.22% a year for next 5 years, tapering down to -0.5% growth in year 10

Operating margin (per-tax) will drop to 14.00%

Sales/Invested Capital will stay at five-year average of 0.79.

Maturity and Closure

Stable Growth
 $g = -0.5\%$;
 Cost of capital = 5%
 ROC = 5%;
 Reinvestment Rate = $-0.5\%/5\% = -10\%$

Euro Cashflows

Terminal Value = $2972 / (.05 - (-0.005)) = 54,034$

	1	2	3	4	5	6	7	8	9	10	Terminal year
Revenue growth rate	3.22%	3.22%	3.22%	3.22%	3.22%	2.48%	1.73%	0.99%	0.24%	-0.50%	-0.50%
Revenues	€ 23,863	€ 24,632	€ 25,425	€ 26,244	€ 27,089	€ 27,759	€ 28,240	€ 28,519	€ 28,589	€ 28,446	€ 28,304
EBIT (Operating) margin	14.38%	14.34%	14.30%	14.26%	14.21%	14.17%	14.13%	14.09%	14.04%	14.00%	14.00%
EBIT (Operating income)	€ 3,432	€ 3,532	€ 3,635	€ 3,741	€ 3,850	€ 3,934	€ 3,990	€ 4,017	€ 4,015	€ 3,982	\$ 3,963
Tax rate	29.70%	29.70%	29.70%	29.70%	29.70%	28.76%	27.82%	26.88%	25.94%	25.00%	\$ 0
EBIT(1-t)	€ 2,413	€ 2,483	€ 2,556	€ 2,630	€ 2,707	€ 2,802	€ 2,880	€ 2,937	€ 2,973	€ 2,987	\$ 2,972
- Reinvestment	€ 942	€ 973	€ 1,004	€ 1,036	€ 1,070	€ 849	€ 609	€ 353	€ 88	€ (181)	\$ (297)
FCFF	€ 1,471	€ 1,511	€ 1,552	€ 1,594	€ 1,637	€ 1,953	€ 2,271	€ 2,584	€ 2,885	€ 3,168	\$ 3,269

PV(Terminal value)	€ 36,390.85
PV (CF over next 10 years)	€ 15,300.34
Value of operating assets =	€ 51,691.19
- Debt	€ 19,709.52
- Minority interests	€ 1,069.00
+ Cash	€ 1,751.60
+ Non-operating assets	€ 1,401.00
Value of equity	€ 34,065.26
Number of shares	571.10
Estimated value /share	€ 59.65
Price	€ 93.25
Price as % of value	56.33%

Discount at Euro Cost of Capital (WACC) = $7.66\% (.599) + 1.13\% (0.401) = 5.04\%$

The Risk in the Cash flows

On September 1, 2019, Heineken was trading at 93.25 Euros/share

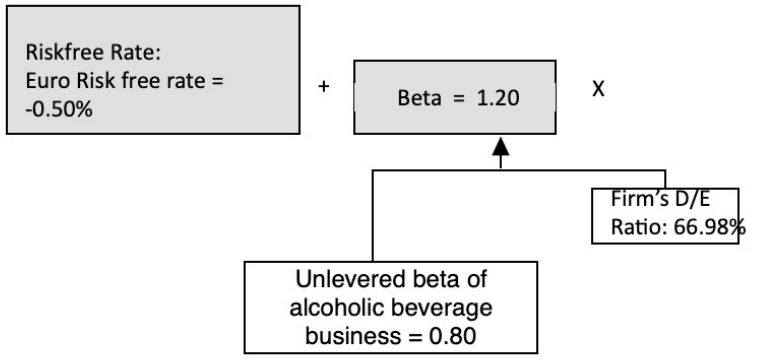
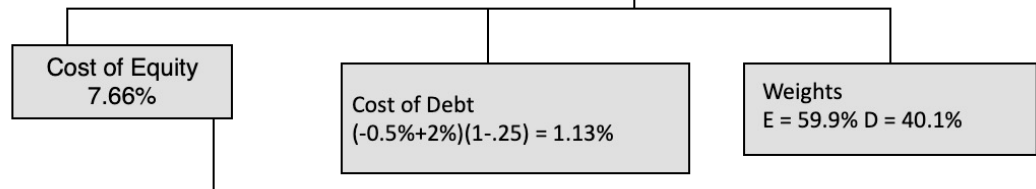

ERP = 6.83%

Region	Revenues	Weight	ERP
Europe	10348	50.24%	6.90%
North America	5920	28.74%	5.75%
Asia	2919	14.17%	7.22%
Latin America & Caribbean	781	3.79%	10.53%
Africa & Mid East	631	3.06%	9.30%
Total	20599	100.00%	6.83%

IV. BETAS DO NOT COME FROM REGRESSIONS... AND ARE NOISY...

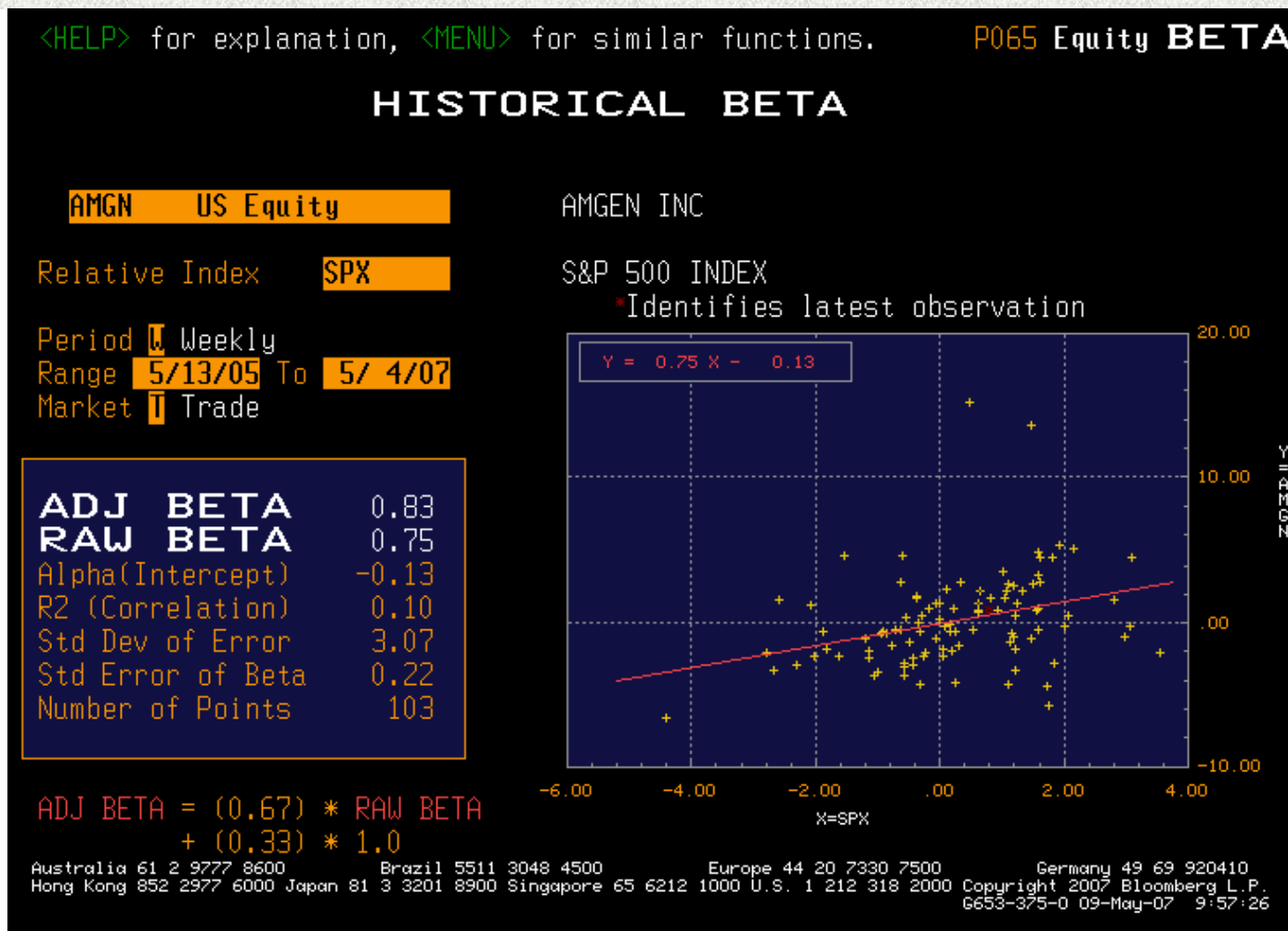

BUT SHOULD NOT BE TRUSTED, EVEN WHEN THEY LOOK GREAT...

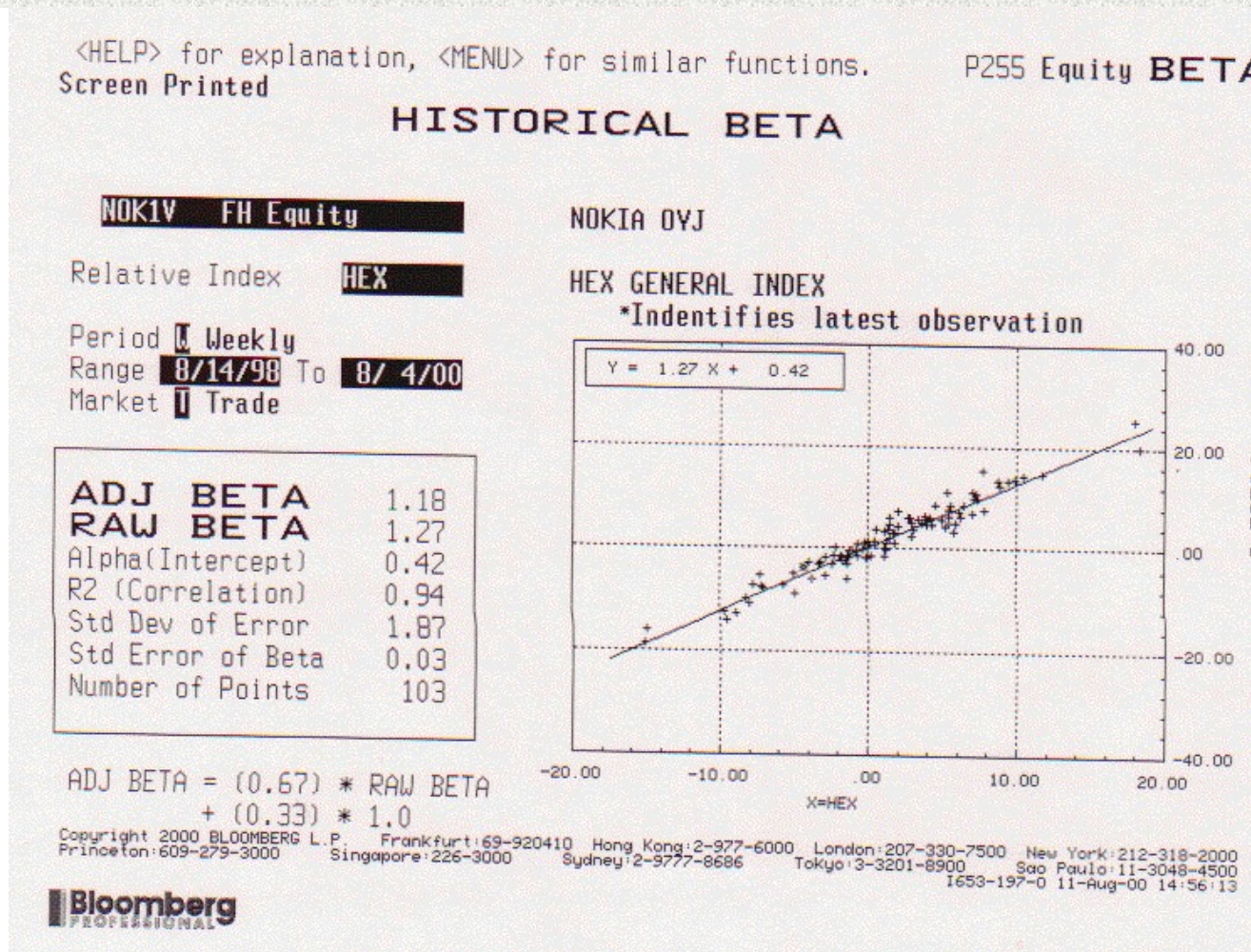

ONE SLICE OF HISTORY...

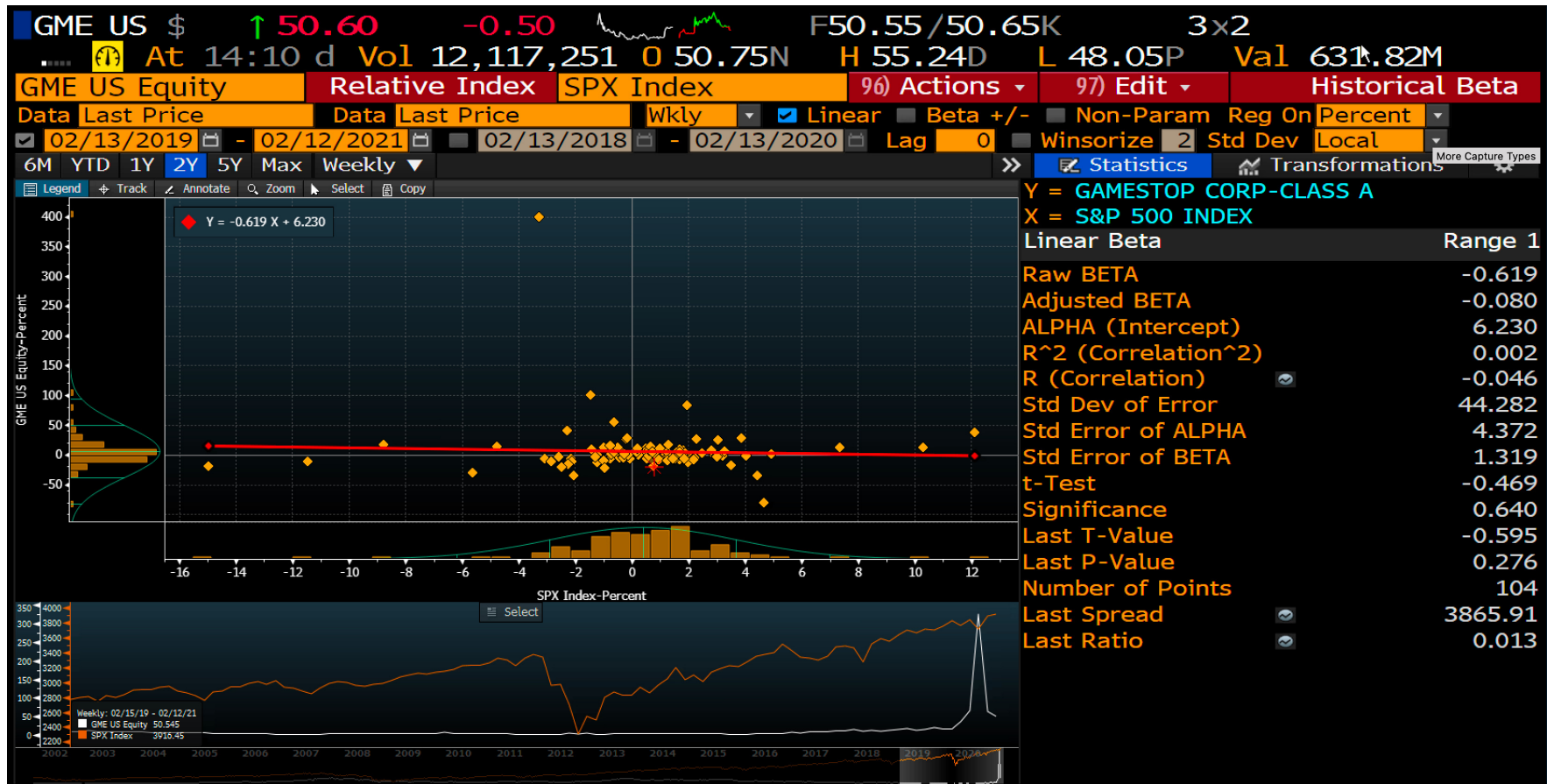

DETERMINANTS OF BETAS

Beta of Equity

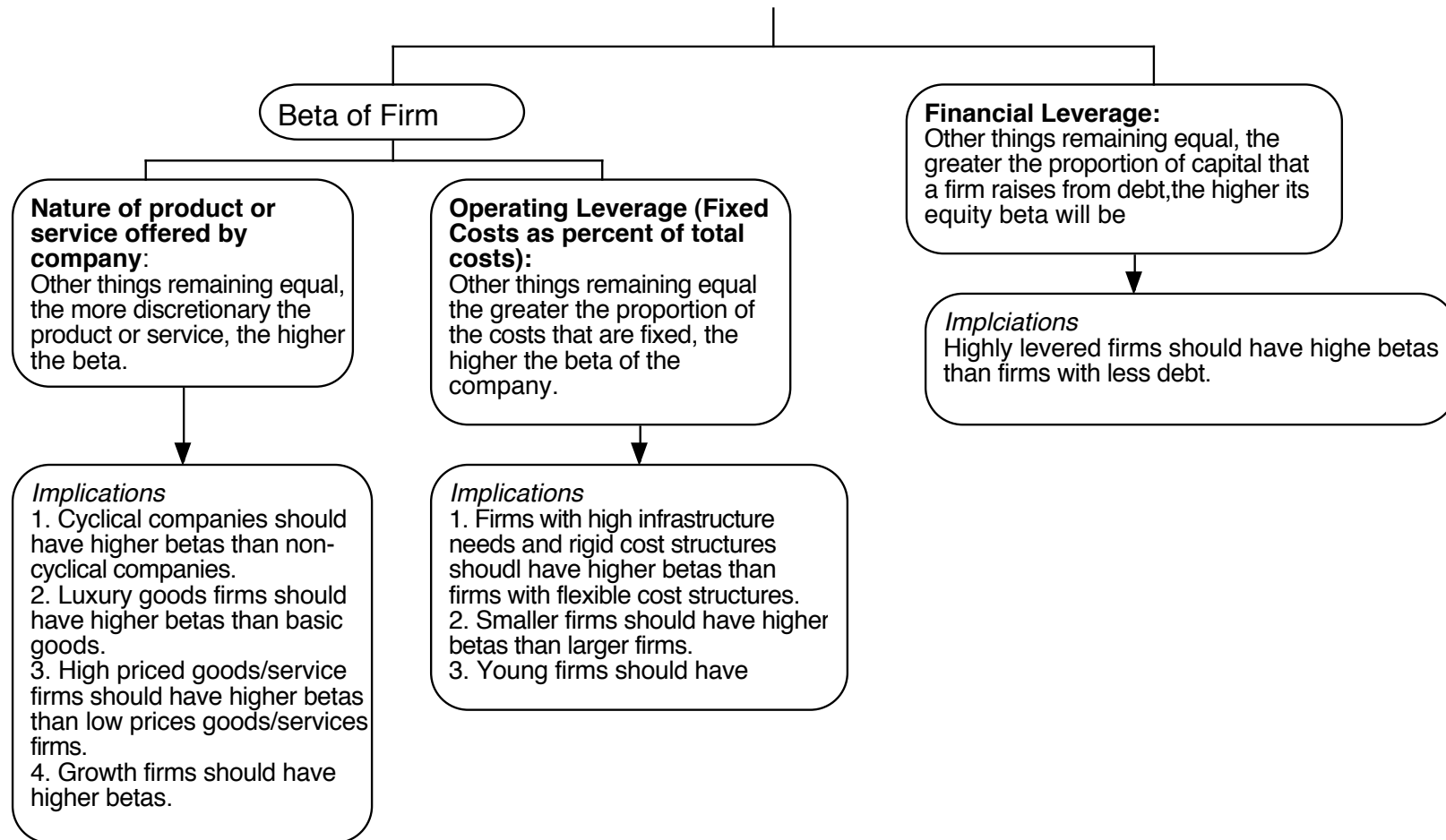

BOTTOM-UP BETAS

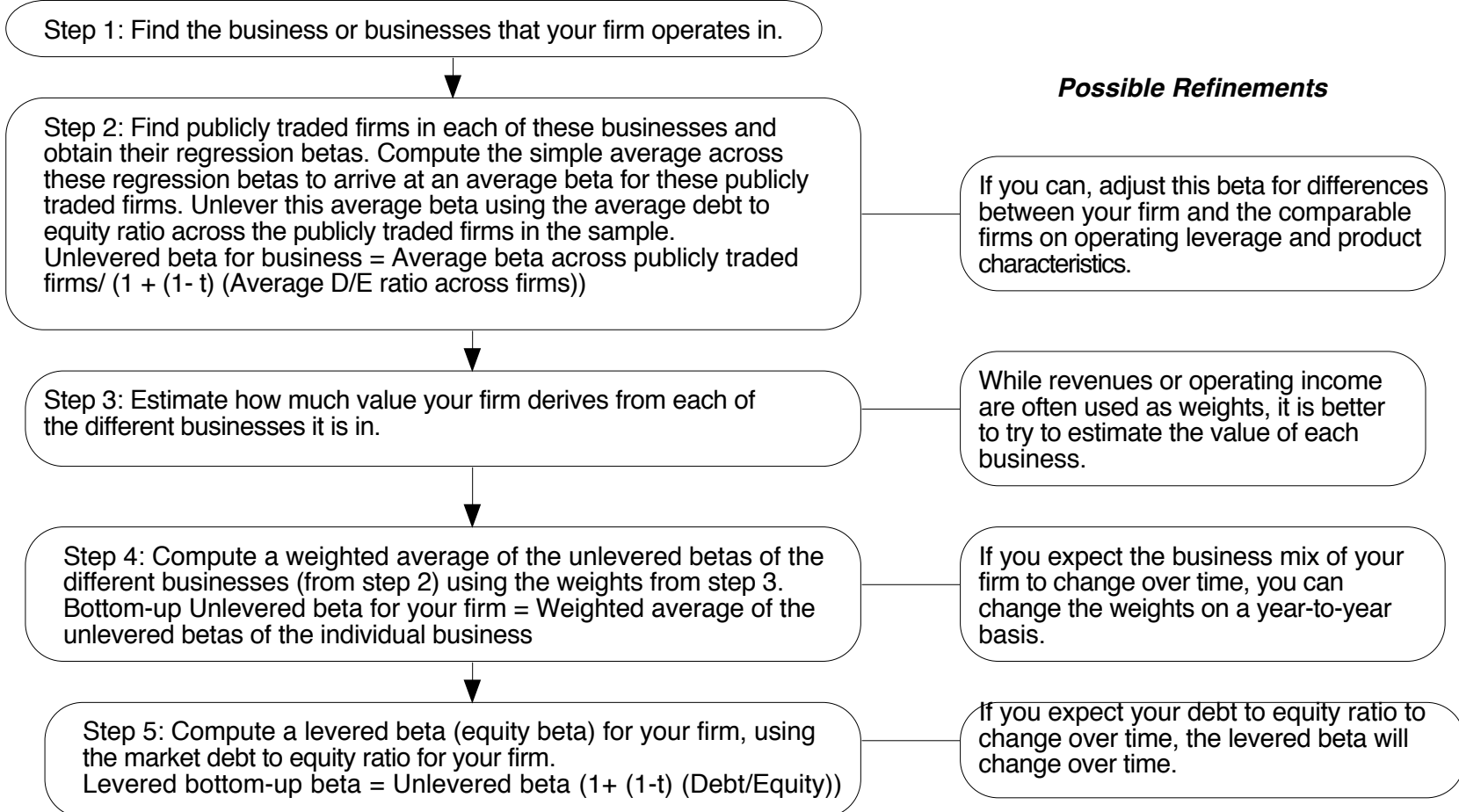

ESTIMATING BOTTOM-UP BETAS: EXAMPLES

- Amgen
 - The unlevered beta for pharmaceutical firms is 1.59.
 - Bottom-up Beta = $1.59 (1 + (1 - .35)(.11)) = 1.73$
- Tata Motors
 - The unlevered beta for automobile firms is 0.98.
 - Bottom-up Beta = $0.98 (1 + (1 - .3399)(.3387)) = 1.20$

- Enka

<i>Business</i>	<i>Revenues</i>	<i>EV/Sales</i>	<i>Value</i>	<i>Unlevered Beta</i>
Engineering/Construction	₹32,015	0.5972	₹19,118	0.7301
Real Estate (General/Diversified)	₹5,703	3.4160	₹19,481	0.5297
Transportation	₹4,085	0.9890	₹4,040	0.8309
Power	₹21,494	1.7852	₹38,372	0.4433
Company	₹63,297		₹81,011	0.5511

Levered Beta = $0.5511 (1 + (1 - .25)(.014)) = 0.56$

- LVMH

<i>Business</i>	<i>Revenues</i>	<i>EV/Sales</i>	<i>Value</i>	<i>Weight</i>	<i>Unlevered Beta</i>
Retail (Special Lines)	\$17,885	1.1950	\$21,372.09	11.75%	0.9619
Apparel	\$61,342	2.3001	\$141,091.66	77.58%	0.6944
Beverage (Alcoholic)	\$6,602	2.9382	\$19,398.30	10.67%	0.7823
Company	\$85,829		\$181,862.06		0.7352

Levered Beta = $0.7352 (1 + (1 - .25)(.1234)) = 0.80$

V. AND THE PAST IS NOT ALWAYS A GOOD INDICATOR OF THE FUTURE.

	<i>Arithmetic Average</i>		<i>Geometric Average</i>	
	Stocks - T. Bills	Stocks - T. Bonds	Stocks - T. Bills	Stocks - T. Bonds
1928-2024	8.44%	7.00%	6.63%	5.44%
Std Error	2.01%	2.12%		
1975-2024	9.25%	7.03%	8.02%	6.22%
Std Error	2.30%	2.67%		
2015-2024	12.34%	13.54%	11.22%	12.71%
Std Error	5.04%	3.84%		

- If you are going to use a historical risk premium, make it
 - **Long term** (because of the standard error)
 - **Consistent** with your risk free rate
 - A “**compounded**” average
- No matter which estimate you use, recognize that it is backward looking, is noisy and may reflect selection bias

BUT IN THE FUTURE..

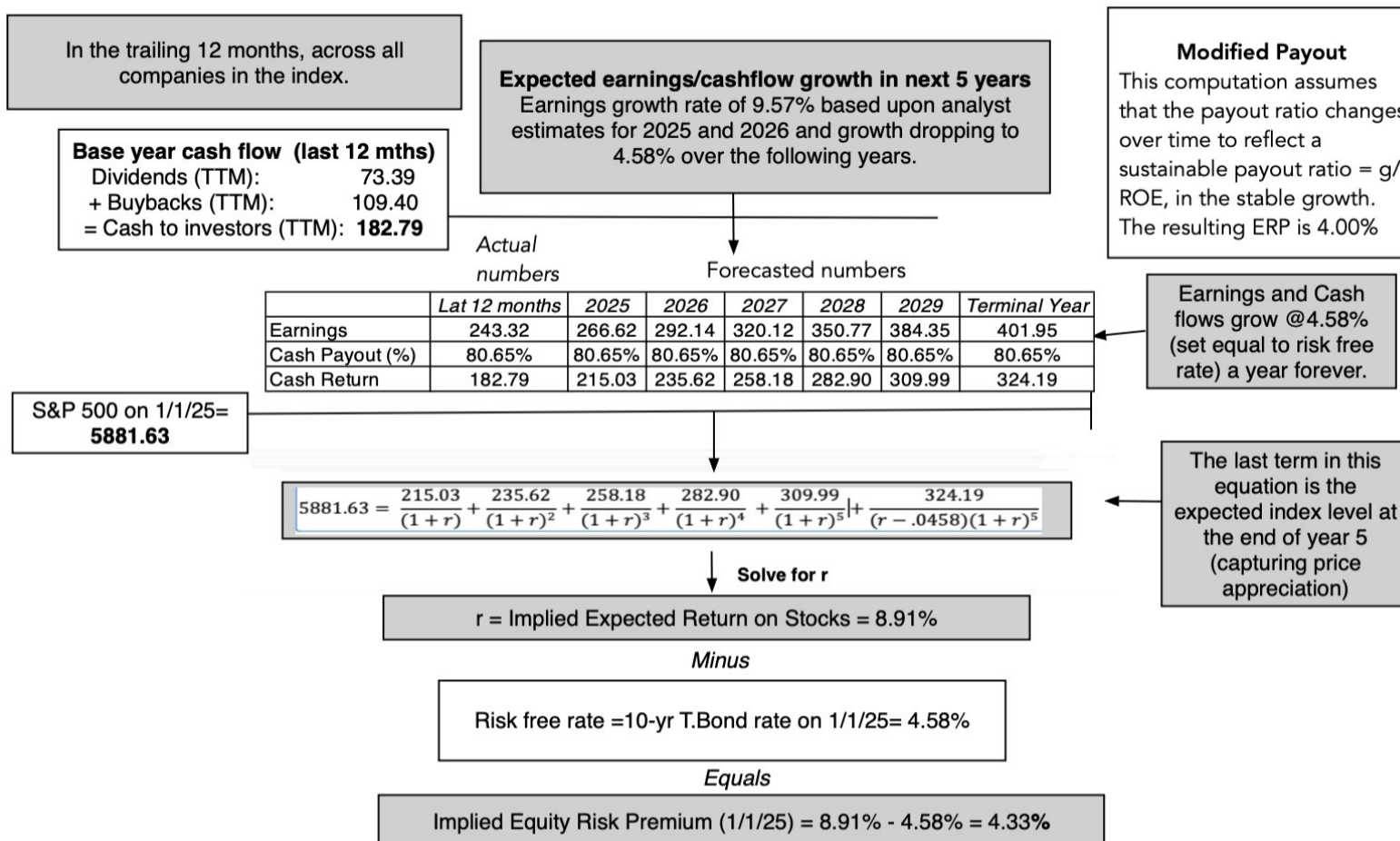

IMPLIED ERP FOR THE S&P 500: HISTORY

Implied Equity Risk Premium for US Equity Market: 1960-2024

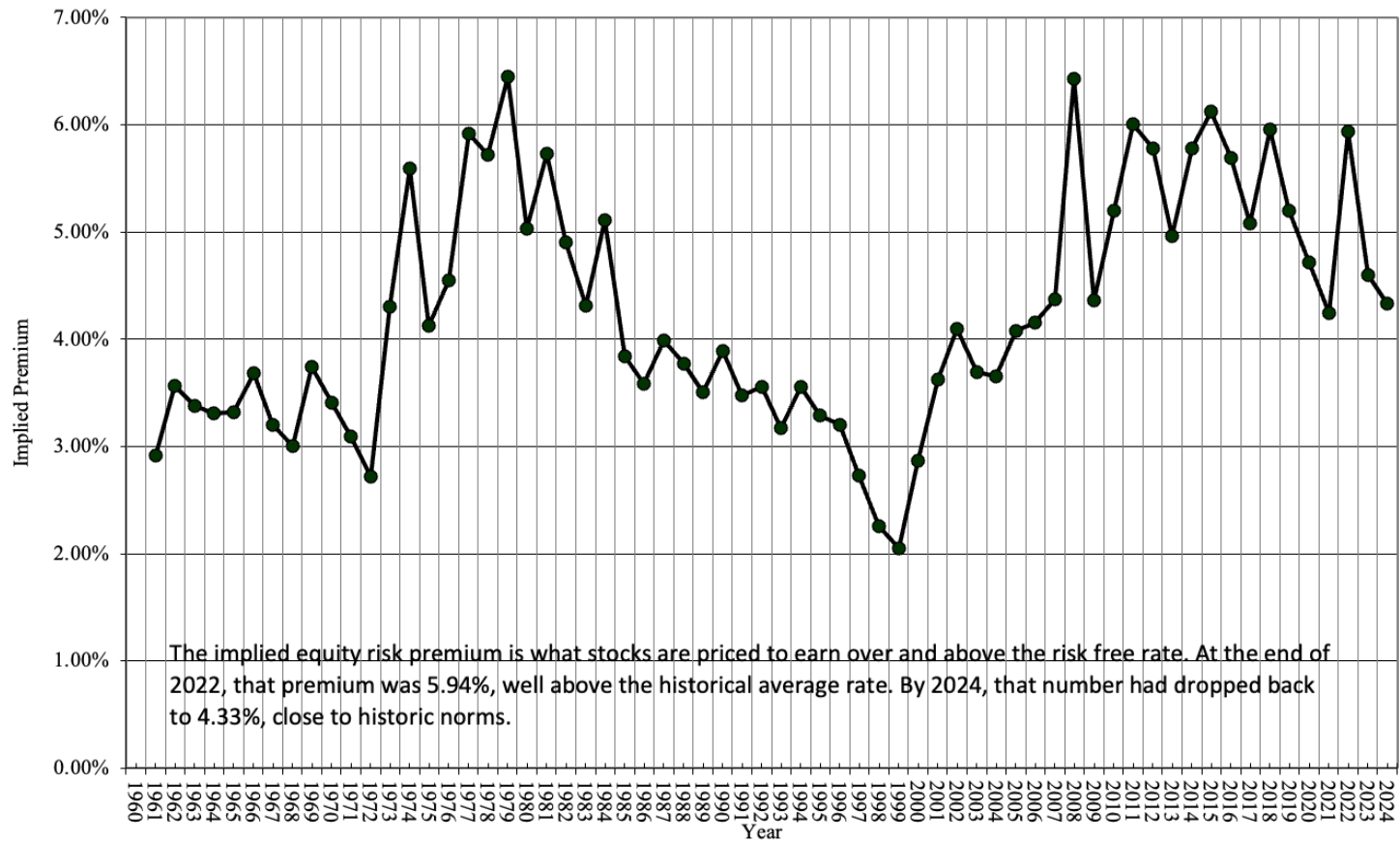

IMPLIED ERP FOR INDIA USING THE SENSEX: APRIL 2010

- Level of the Index = 17559
- FCFE on the Index = 3.5% (Estimated FCFE for companies in index as % of market value of equity)
- Other parameters
 - Riskfree Rate = 5% (Rupee)
 - Expected Growth (in Rupee)
 - Next 5 years = 20% (Used expected growth rate in Earnings)
 - After year 5 = 5%
- Solving for the expected return:
 - Expected return on Equity = 11.72%
 - Implied Equity premium for India = $11.72\% - 5\% = 6.72\%$

VI. THERE IS A DOWNSIDE TO GLOBALIZATION...

- Emerging markets offer growth opportunities but they are also riskier. If we want to count the growth, we have to also consider the risk. To estimate the country risk premium:
 - **Start with the sovereign default spread:** In this approach, the country equity risk premium is set equal to the default spread of the bond issued by the country.
 - **Adjust for equity risk:** The country equity risk premium is based upon the volatility of the equity market relative to the government bond rate.
 - $\text{Country risk premium} = \text{Default Spread} \times \frac{\text{Std Deviation}_{\text{Country Equity}}}{\text{Std Deviation}_{\text{Country Bond}}}$
 - Standard Deviation in Sensex = 21%
 - Standard Deviation in Indian government bond = 14%
 - Default spread on Indian Bond = 2%
 - Additional country risk premium for India = $2\% \times (21/14) = 3.00\%$
 - Total equity risk premium = US equity risk premium + CRP for India
= 6.00% + 3.00% = 9.00%

A TEMPLATE FOR ESTIMATING THE ERP

ERP Estimation Procedure - January 1, 2025

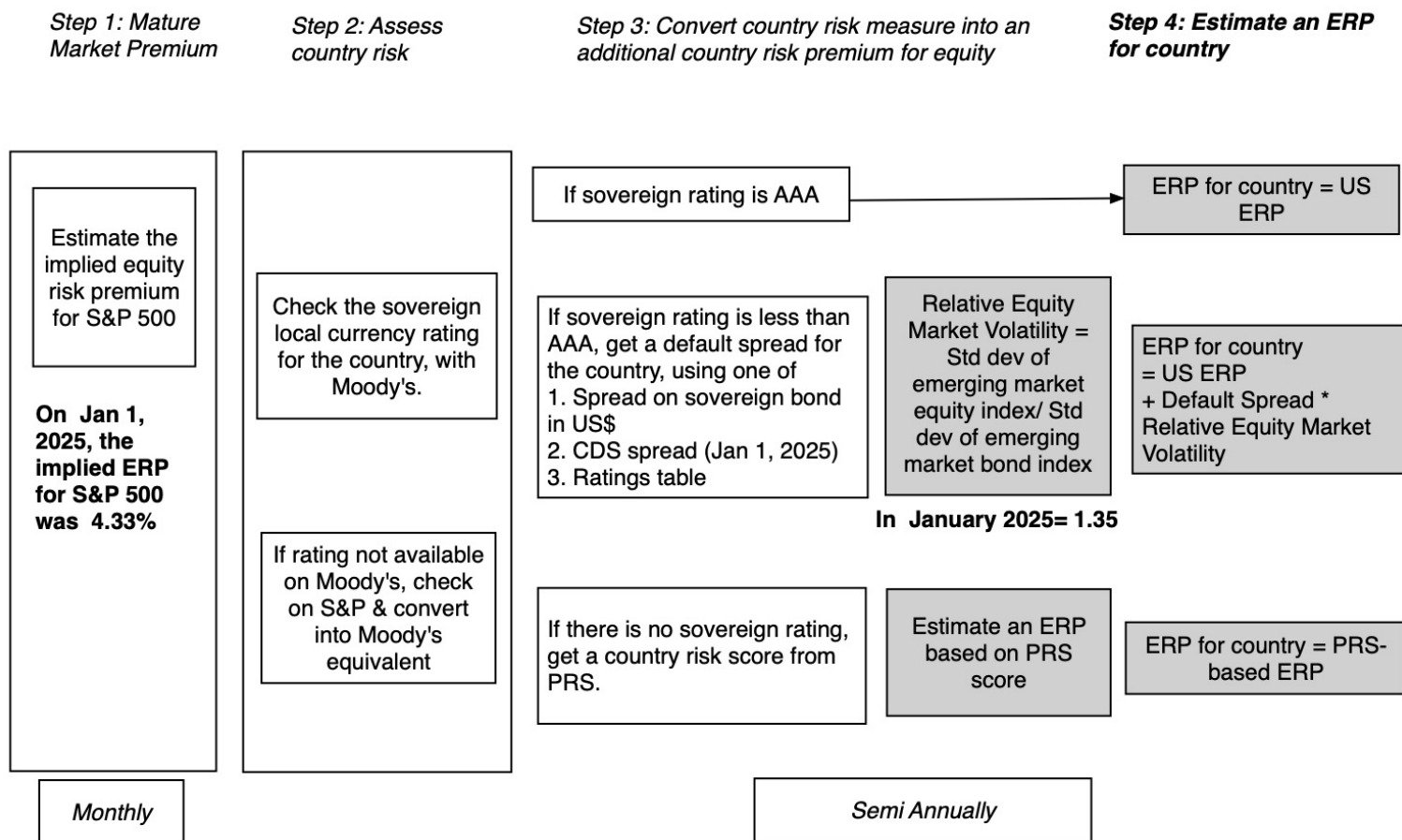

Andorra	Baa1	2.13%	6.46%	Jersey	Aa2	0.66%	4.99%
Austria	Aa1	0.53%	4.86%	Liechtenstein	Aaa	0.00%	4.33%
Belgium	Aa3	0.80%	5.13%	Luxembourg	Aaa	0.00%	4.33%
Cyprus	A3	1.60%	5.93%	Malta	A2	1.13%	5.46%
Denmark	Aaa	0.00%	4.33%	Netherlands	Aaa	0.00%	4.33%
Finland	Aa1	0.53%	4.86%	Norway	Aaa	0.00%	4.33%
France	Aa3	0.80%	5.13%	Portugal	A3	1.60%	5.93%
Germany	Aaa	0.00%	4.33%	Spain	Baa1	2.13%	6.46%
Greece	Ba1	3.34%	7.67%	Sweden	Aaa	0.00%	4.33%
Guernsey	A1	0.94%	5.27%	Switzerland	Aaa	0.00%	4.33%
Iceland	A1	0.94%	5.27%	Turkey	B1	6.01%	10.34%
Ireland	Aa3	0.80%	5.13%	United Kingdom	Aa3	0.80%	5.13%
Isle of Man	Aa3	0.80%	5.13%	Western Europe		1.12%	5.45%
Italy	Baa3	2.93%	7.26%				

Albania	Ba3	4.80%	9.13%
Armenia	Ba3	4.80%	9.13%
Azerbaijan	Ba1	3.34%	7.67%
Belarus	C	23.58%	27.91%
Bosnia and Herzegovina	B3	8.67%	13.00%
Bulgaria	Baa1	2.13%	6.46%
Croatia	A3	1.60%	5.93%
Czech Republic	Aa3	0.80%	5.13%
Estonia	A1	0.94%	5.27%
Georgia	Ba2	4.02%	8.35%
Hungary	Baa2	2.54%	6.87%
Kazakhstan	Baa1	2.13%	6.46%
Kyrgyzstan	B3	8.67%	13.00%
Latvia	A3	1.60%	5.93%
Lithuania	A2	1.13%	5.46%
Macedonia	Ba3	4.80%	9.13%
Moldova	B3	8.67%	13.00%
Montenegro	B1	6.01%	10.34%
Poland	A2	1.13%	5.46%
Romania	Baa3	2.93%	7.26%
Serbia	Ba2	4.02%	8.35%
Slovakia	A3	1.60%	5.93%
Slovenia	A3	1.60%	5.93%
Tajikistan	B3	8.67%	13.00%
Ukraine	Ca	16.02%	20.35%
Uzbekistan	Ba3	4.80%	9.13%
Eastern Europe		3.40%	7.73%

Country	PRS	CRP	ERP
Algeria	69.25	3.52%	7.85%
Brunei	81.75	0.70%	5.03%
Gambia	67.5	5.26%	9.59%
Guinea	57.75	10.52%	14.85%
Guinea-Bissau	63.25	7.60%	11.93%
Guyana	75.75	1.87%	6.20%
Haiti	54.75	14.03%	18.36%
Iran	63.75	7.60%	11.93%
Korea, D.P.R.	51	14.03%	18.36%
Liberia	58.25	10.52%	14.85%
Libya	74.5	1.87%	6.20%
Madagascar	64.5	6.43%	10.76%
Malawi	57.75	10.52%	14.85%
Myanmar	56	11.69%	16.02%
Russia	69.25	3.52%	7.85%
Sierra Leone	59.5	10.52%	14.85%
Somalia	55.5	11.69%	16.02%
Sudan	43.5	20.65%	24.98%
Syria	46.5	20.65%	24.98%
Yemen, Republic	51.5	14.03%	18.36%
Zimbabwe	57.75	10.52%	14.85%

Canada	Aaa	0.00%	4.33%
United States	Aaa	0.00%	4.33%
North America		0.00%	4.33%

Caribbean		8.10%	12.43%
------------------	--	--------------	---------------

Argentina	Ca	16.02%	20.35%
Belize	Caa1	10.01%	14.34%
Bolivia	Caa3	13.35%	17.68%
Brazil	Ba1	3.34%	7.67%
Chile	A2	1.13%	5.46%
Colombia	Baa2	2.54%	6.87%
Costa Rica	Ba3	4.80%	9.13%
Ecuador	Caa3	13.35%	17.68%
El Salvador	B3	8.67%	13.00%
Guatemala	Ba1	3.34%	7.67%
Honduras	B1	6.01%	10.34%
Mexico	Baa2	2.54%	6.87%
Nicaragua	B2	7.34%	11.67%
Panama	Baa3	2.93%	7.26%
Paraguay	Baa3	2.93%	7.26%
Peru	Baa1	2.13%	6.46%
Suriname	Caa1	10.01%	14.34%
Uruguay	Baa1	2.13%	6.46%
Venezuela	C	23.58%	27.91%
Latin America		4.82%	9.15%

Country	Rating	CRP	ERP
Angola	B3	8.67%	13.00%
Benin	B1	6.01%	10.34%
Botswana	A3	1.60%	5.93%
Burkina Faso	Caa1	10.01%	14.34%
Cameroon	Caa1	10.01%	14.34%
Cape Verde	B2	7.34%	11.67%
Congo (DR)	B3	8.67%	13.00%
Congo (Rep)	Caa2	12.02%	16.35%
Côte d'Ivoire	Ba2	4.02%	8.35%
Egypt	Caa1	10.01%	14.34%
Ethiopia	Caa2	12.02%	16.35%
Gabon	Caa2	12.02%	16.35%
Ghana	Caa2	12.02%	16.35%
Kenya	Caa1	10.01%	14.34%
Mali	Caa2	12.02%	16.35%
Mauritius	Baa3	2.93%	7.26%
Morocco	Ba1	3.34%	7.67%
Mozambique	Caa2	12.02%	16.35%
Namibia	B1	6.01%	10.34%
Niger	Caa3	13.35%	17.68%
Nigeria	Caa1	10.01%	14.34%
Rwanda	B2	7.34%	11.67%
Senegal	B1	6.01%	10.34%
South Africa	Ba2	4.02%	8.35%
Swaziland	B2	7.34%	11.67%
Tanzania	B1	6.01%	10.34%
Togo	B3	8.67%	13.00%
Tunisia	Caa2	12.02%	16.35%
Uganda	B3	8.67%	13.00%
Zambia	Caa2	12.02%	16.35%
Africa		8.31%	12.64%

Abu Dhabi	Aa2	0.66%	4.99%
Bahrain	B2	7.34%	11.67%
Iraq	Caa1	10.01%	14.34%
Israel	Baa1	2.13%	6.46%
Jordan	Ba3	4.80%	9.13%
Kuwait	A1	0.94%	5.27%
Lebanon	C	23.58%	27.91%
Oman	Ba1	3.34%	7.67%
Qatar	Aa2	0.66%	4.99%
Ras Al Khaimah (Emirate)	A3	1.60%	5.93%
Saudi Arabia	Aa3	0.80%	5.13%
Sharjah	Ba1	3.34%	7.67%
United Arab Emirates	Aa2	0.66%	4.99%
Middle East		2.10%	6.43%

Bangladesh	B2	7.34%	11.67%
Cambodia	B2	7.34%	11.67%
China	A1	0.94%	5.27%
Fiji	B1	6.01%	10.34%
Hong Kong	Aa3	0.80%	5.13%
India	Baa3	2.93%	7.26%
Indonesia	Baa2	2.54%	6.87%
Japan	A1	0.94%	5.27%
Korea	Aa2	0.66%	4.99%
Laos	Caa3	13.35%	17.68%
Macao	Aa3	0.80%	5.13%
Malaysia	A3	1.60%	5.93%
Maldives	Caa2	12.02%	16.35%
Mongolia	B2	7.34%	11.67%
Nepal	Ba3	4.80%	9.13%
Pakistan	Caa2	12.02%	16.35%
Papua New Guinea	B2	7.34%	11.67%
Philippines	Baa2	2.54%	6.87%
Singapore	Aaa	0.00%	4.33%
Solomon Islands	Caa1	10.01%	14.34%
Sri Lanka	Ca	16.02%	20.35%
Taiwan	Aa3	0.80%	5.13%
Thailand	Baa1	2.13%	6.46%
Vietnam	Ba2	4.02%	8.35%
Asia		1.44%	5.72%

Australia	Aaa	0.00%	4.33%
Cook Islands	B1	6.01%	10.34%
New Zealand	Aaa	0.00%	4.33%
Australia & NZ		0.00%	4.33%

VII. AND IT IS NOT JUST EMERGING MARKET COMPANIES THAT ARE EXPOSED TO THIS RISK..

- The “default” approach in valuation **has been to assign country risk based upon your country of incorporation.** Thus, if you are incorporated in a developed market, the assumption has been that you are not exposed to emerging market risks. If you are incorporated in an emerging market, you are saddled with the entire country risk.
- As companies globalize and look for revenues in foreign markets, this practice will **underestimate the costs of equity of developed market companies** with significant emerging market risk exposure and **over estimate the costs of equity of emerging market companies** with significant developed market risk exposure.

EQUITY RISK PREMIUM IN 2024: ENKA AND LVMH

Enka

Country	Revenues	ERP	Weight	Weighted ER
Turkey	₺41,194	10.34%	51.82%	5.36%
Russia	₺22,997	8.35%	28.93%	2.41%
Europe	₺9,832	5.45%	12.37%	0.67%
Rest of the	₺5,478	5.76%	6.89%	0.40%
Total	₺79,501		100.00%	8.84%

LVMH

Region	Revenues	Weight	ERP
Asia	€ 32,891	37.99%	5.77%
Central and South America	€ 5,830	6.73%	9.15%
North America	€ 21,764	25.14%	4.33%
Western Europe	€ 8,731	10.09%	5.45%
France	€ 6,830	7.89%	5.87%
Rest of the World	€ 10,523	12.16%	5.50%
Total	€ 86,569	100.00%	5.58%

Questions to ponder:

1. I used **revenue weights**. Why?
2. Under what conditions would you consider using **alternate metrics** like EBIT or BV of assets as weights?

A PRODUCTION-BASED ERP: ROYAL DUTCH SHELL IN 2015

Country	Oil & Gas Production	% of Total	ERP
Denmark	17396	3.83%	6.20%
Italy	11179	2.46%	9.14%
Norway	14337	3.16%	6.20%
UK	20762	4.57%	6.81%
Rest of Europe	874	0.19%	7.40%
Brunei	823	0.18%	9.04%
Iraq	20009	4.40%	11.37%
Malaysia	22980	5.06%	8.05%
Oman	78404	17.26%	7.29%
Russia	22016	4.85%	10.06%
Rest of Asia & ME	24480	5.39%	7.74%
Oceania	7858	1.73%	6.20%
Gabon	12472	2.75%	11.76%
Nigeria	67832	14.93%	11.76%
Rest of Africa	6159	1.36%	12.17%
USA	104263	22.95%	6.20%
Canada	8599	1.89%	6.20%
Brazil	13307	2.93%	9.60%
Rest of Latin America	576	0.13%	10.78%
Royal Dutch Shell	454326	100.00%	8.26%

ESTIMATING COUNTRY RISK PREMIUM EXPOSURE_VARIANTS

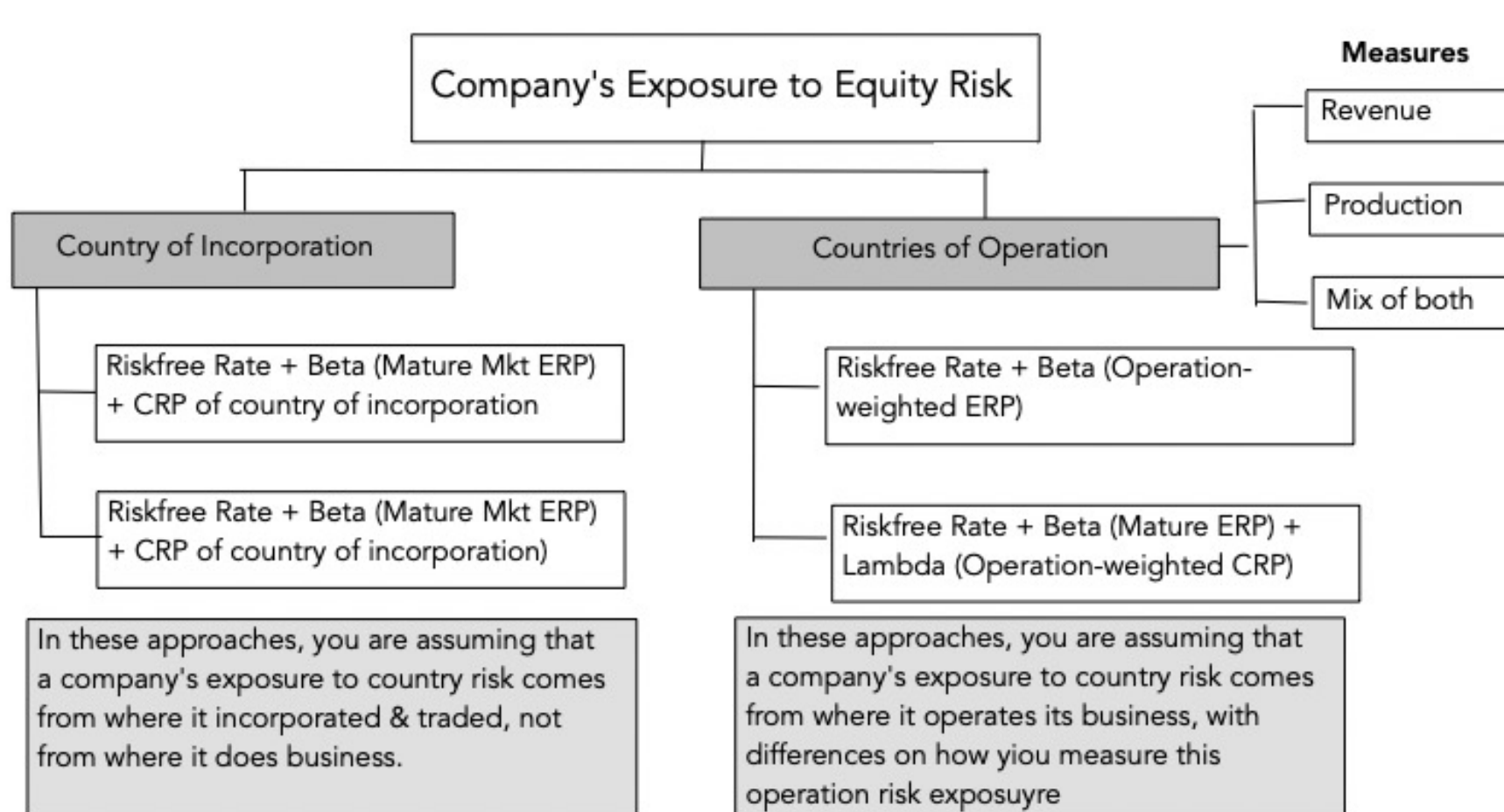

AN ALTERNATE WAY: ESTIMATING A COMPANY'S EXPOSURE TO COUNTRY RISK (LAMBDA)

- Just as beta measures exposure to macro economic risk, lambda measures exposure just to country risk. Like beta, it is scaled around one.
- The easiest and most accessible data is on revenues. Most companies break their revenues down by region. One simplistic solution would be to do the following:
 - $\text{Lambda} = \frac{\% \text{ of revenues domestically firm}}{\% \text{ of revenues domestically average firm}}$
 - However, you should be incorporating other country risk factors into lambda.

	<i>Tata Motors</i>	<i>TCS</i>
% of production/operations in India	High	High
% of revenues in India	91.37% (in 2009) Estimated 70% (in 2010)	7.62%
Lambda	0.80	0.20
Flexibility in moving operations	Low. Significant physical assets.	High. Human capital is mobile.

VIII. GROWTH HAS TO BE EARNED (NOT ENDOWED OR ESTIMATED): SUSTAINABLE GROWTH

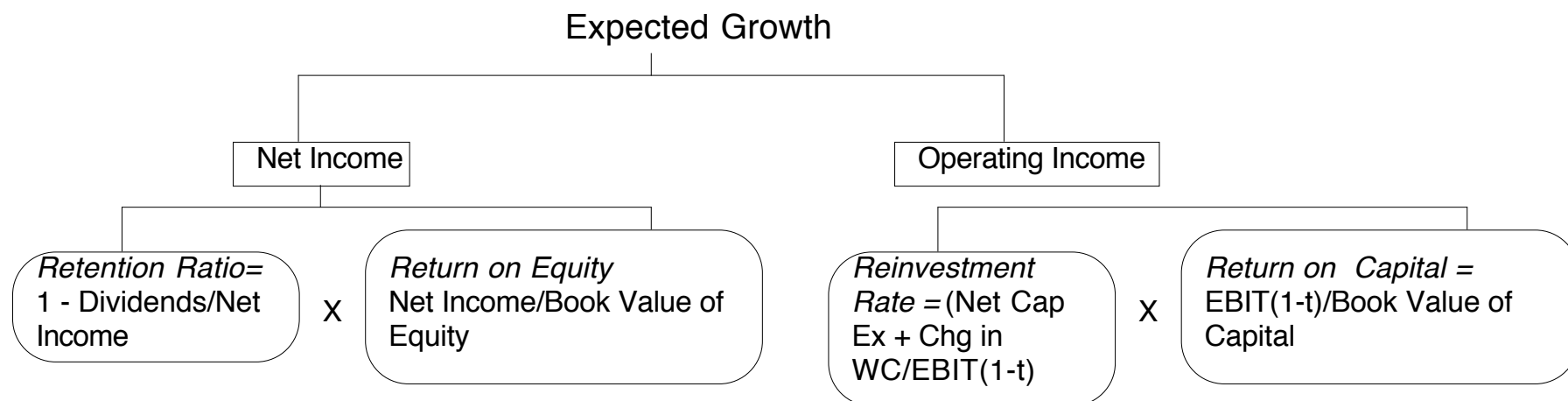

- **No free growth:** In the long term, to grow, you have to reinvest.
- **Growth Quality:** For a given reinvestment, the higher the return you generate on your reinvestment, the faster you can grow.
- **Scaling up is hard to do:** As companies get larger, it gets more difficult to sustain value-adding growth.

EARN AT LEAST YOUR COST OF CAPITAL! BUT COMPANIES SEEM TO HAVE TROUBLE IN PRACTICE...

<i>Region</i>	<i># firms</i>	<i>ROE</i>	<i>COE</i>	<i>% of firms with ROE>COE</i>	<i>ROIC</i>	<i>WACC</i>	<i>% of firms with ROIC>WACC</i>	<i>% of firms with ROIC-WACC>5%</i>	<i>% of firms with ROIC-WACC<5%</i>
Africa and Middle East	2,423	7.55%	10.98%	32.03%	4.77%	9.33%	25.05%	16.59%	83.41%
Australia & NZ	1,798	-12.08%	8.51%	18.19%	-11.59%	8.36%	19.24%	13.68%	86.32%
Canada	2,791	-20.66%	8.64%	11.64%	-18.59%	8.41%	12.54%	8.10%	91.90%
China	7,504	4.34%	10.07%	23.87%	3.36%	8.94%	25.49%	15.27%	84.73%
EU & Environs	5,925	6.73%	9.83%	33.96%	5.48%	8.59%	33.59%	24.76%	75.24%
Eastern Europe & Russia	325	10.17%	10.38%	34.46%	4.32%	9.17%	26.46%	16.31%	83.69%
India	4,446	8.32%	11.12%	34.14%	5.61%	9.90%	29.94%	19.50%	80.50%
Japan	4,020	7.14%	10.05%	33.23%	7.15%	8.62%	41.32%	26.87%	73.13%
Latin America & Caribbean	984	9.28%	12.30%	35.37%	7.37%	9.76%	35.98%	24.19%	75.81%
Small Asia	9,876	5.19%	10.86%	25.65%	3.81%	9.37%	23.78%	14.14%	85.86%
UK	1,125	1.47%	9.71%	29.16%	4.76%	8.74%	37.16%	28.80%	71.20%
United States	6,481	2.64%	8.80%	26.68%	0.05%	7.91%	23.59%	17.74%	82.26%
Global	47,698	4.93%	9.92%	27.54%	3.73%	8.68%	27.12%	18.02%	81.98%

WHEN EVERYTHING IS IN FLUX: CHANGING GROWTH AND MARGINS

- The elegant connection between reinvestment and earnings growth, captured by a sustainable growth rate, when you have a company in transition, and margins are changing over time.
- If that is the case, you have to estimate cash flows in three steps:
 - Forecast revenue growth and revenues in future years, taking into account market potential and competition.
 - **Forecast a “target” operating margin** in the future and a pathway from current margins to the target.
 - **Estimate reinvestment from revenues**, using a sales to capital ratio (measuring the dollars of revenues you get from each dollar of investment).

1. REVENUE GROWTH

Revenue Growth and Magnitude

Market Size and Growth

1. *Current Market size*: The size of the market for the company's products & services, given geography it is targeting and product type.
2. *Expected Growth in Market*: Growth in total market, as technology and market conditions change.

X

Market Share

1. *Company's current market share*: If company's current market share is low, potential for growth in market share at expense of competition.
2. *Industry economics*: Nature of the business (a few big winners or splintered competition).
3. *Strength of company's competitive advantages*: Stronger and more sustainable competitive advantages should allow for higher market share.

The potential for revenue growth is greater for companies with small revenues (and market share) in a big and growing market, especially if the company has strong competitive advantages in winner-take-all businesses.

2. TARGET MARGINS (AND PATH THERE)...

Operating Margin: Target and Pathway

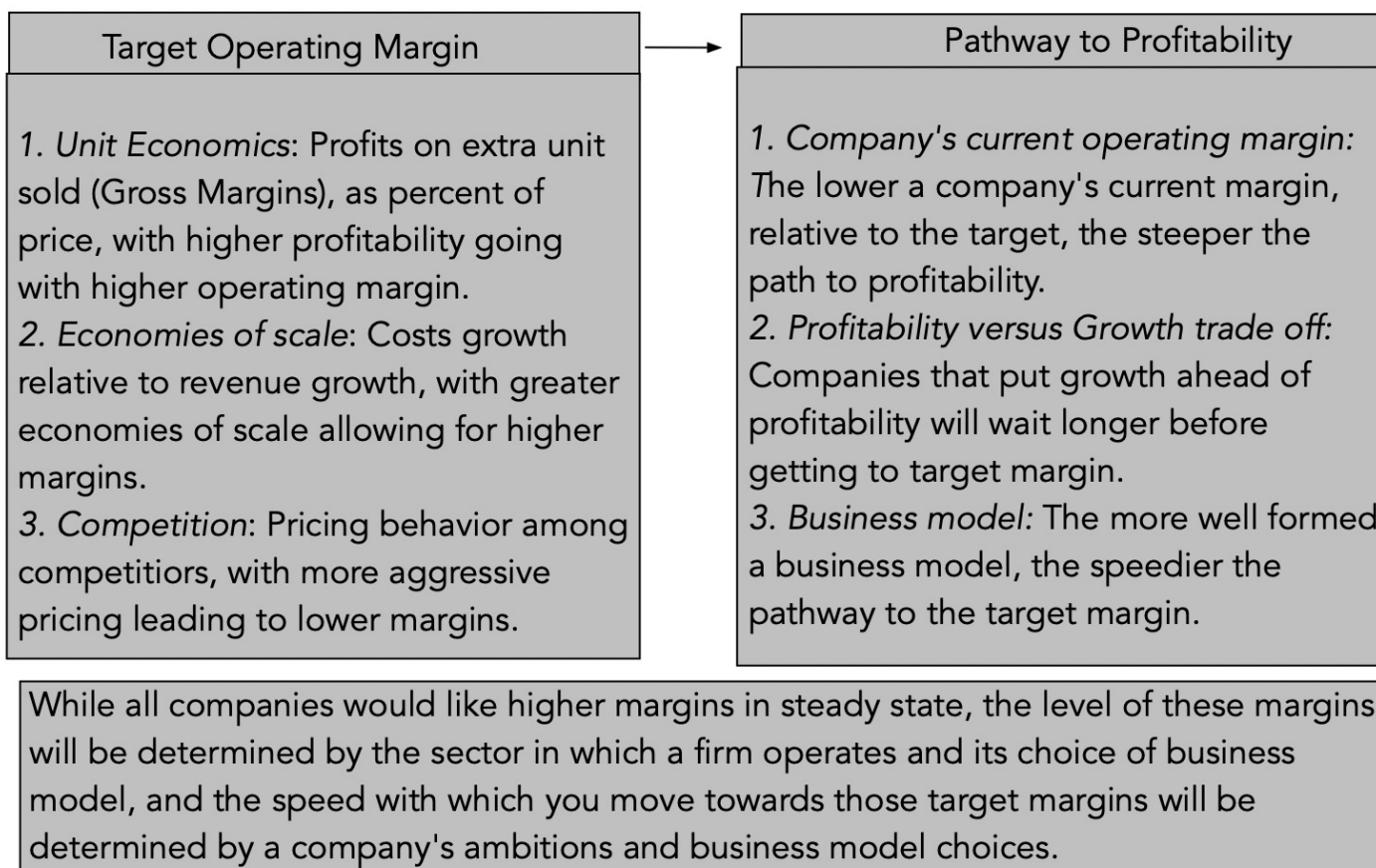

3. SALES TO INVESTED CAPITAL: A PATHWAY TO ESTIMATING REINVESTMENT

Sales to Invested Capital: Reinvestment

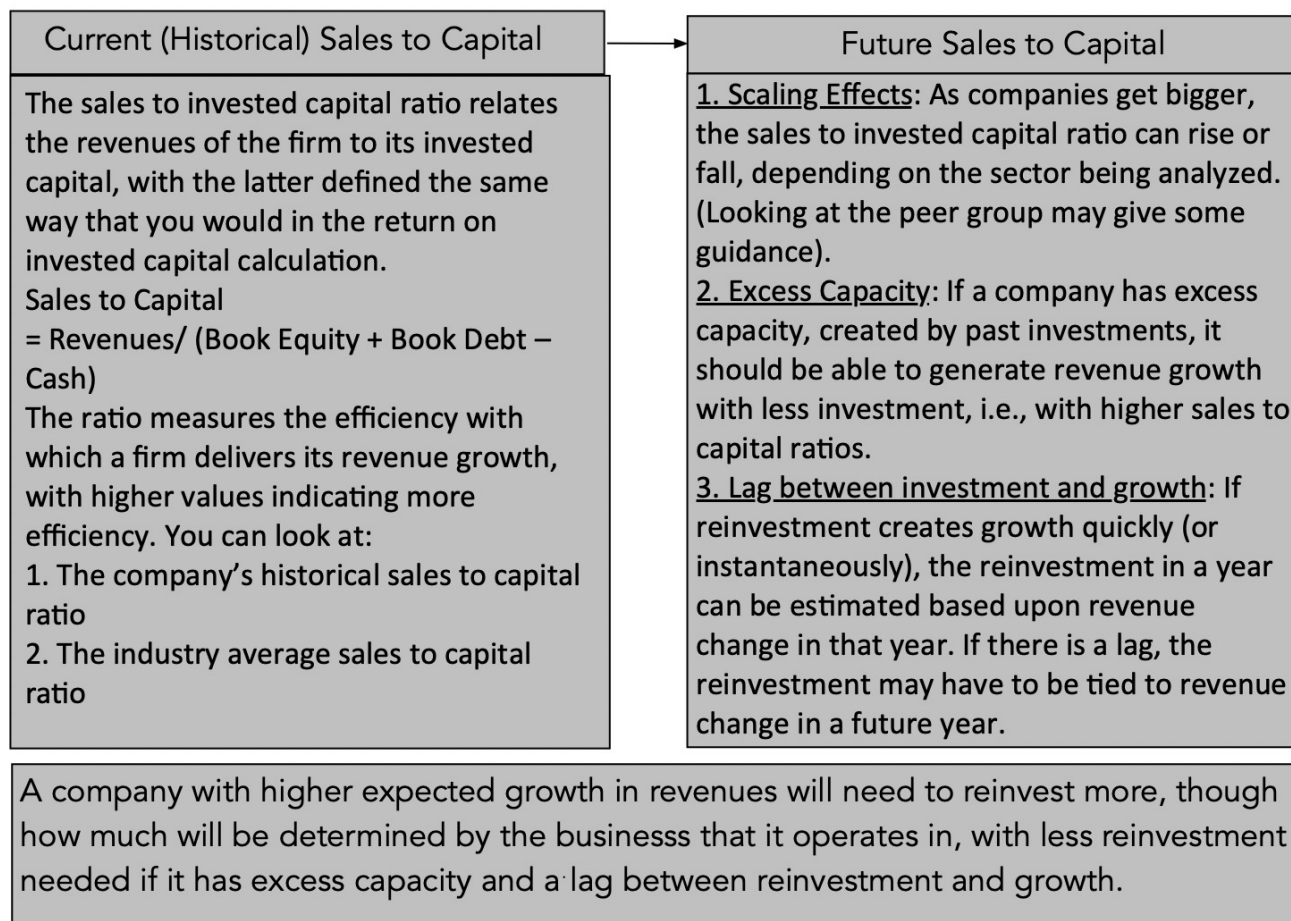

IX. ALL GOOD THINGS COME TO AN END..AND THE TERMINAL VALUE IS NOT AN ATM...

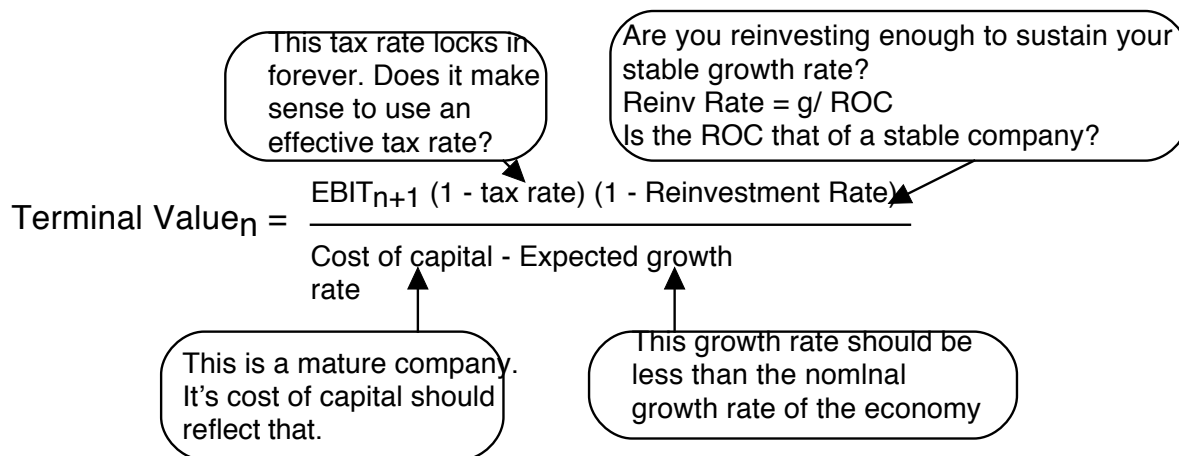

Myth 5.1: The only way to estimate terminal value is to use the perpetual growth model.

Myth 5.2: The perpetual growth model can give you an infinite value.

Myth 5.3: The growth rate is your biggest driver of terminal value.

Myth 5.4: Your growth rate cannot be negative in a perpetual growth model.

Myth 5.5: If your terminal value is a high proportion of your DCF value, it is flawed.

$$\text{Value of an asset with life } > n \text{ years} = \frac{E(CF_1)}{(1+r)^1} + \frac{E(CF_2)}{(1+r)^2} + \dots + \frac{E(CF_n)}{(1+r)^n} + \frac{\text{Terminal Value}_n}{(1+r)^n}$$

Truth 5.1: The terminal value can be based on annuities or a liquidation value.

Truth 5.2: Not if growth forever is capped at the growth rate of the economy.

Truth 5.3: Growth is not free & increasing growth can add or destroy value.

Truth 5.4: Growth can be negative forever & is often more reflective of reality.

Truth 5.5: The terminal value should be a high percent of value today.

TERMINAL VALUE AND GROWTH

Stable Growth Rate	Amgen	Tata Motors	Enka	LVMH
0%	\$150,652	₹ 435,686	TL 418,003	€337,744
1%	\$154,479	₹ 435,686	TL 422,403	€376,093
2%	\$160,194	₹ 435,686	TL 488,525	€427,235
3%	\$167,784	₹ 435,686	TL 507,327	
4%	\$179,099	₹ 435,686	TL 520,336	
5%		₹ 435,686	TL 613,253	
10%			TL 854,837	
15%			TL	
Risk free Rate	4.78%	5.00%	15%	2.63%
ROIC	10.00%	10.39%	25%	12.00%
Cost of capital	8.08%	10.39%	20%	6.96%

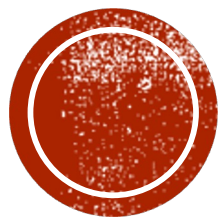

INTRINSIC VALUATION: LOOSE ENDS

A premium here, a discount there, and soon you are where you wanted to be in the first place..

GETTING FROM DCF TO VALUE PER SHARE: THE LOOSE ENDS

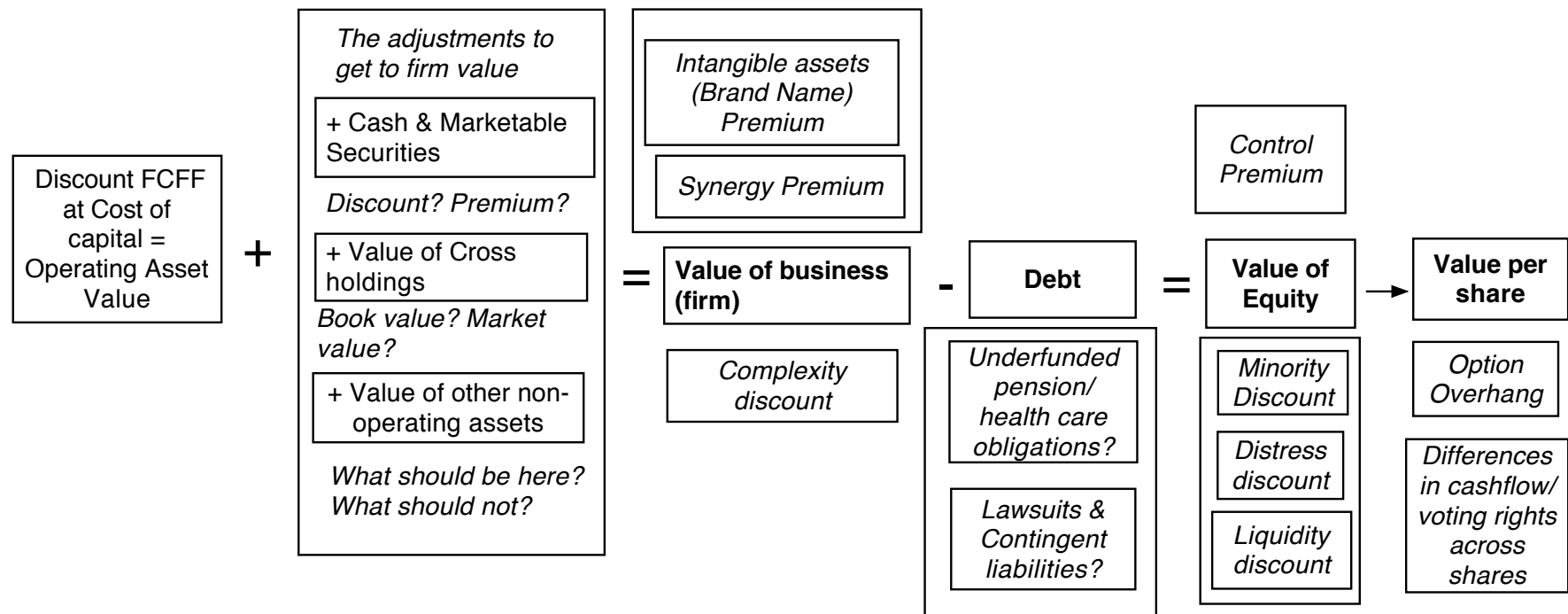

1. THE VALUE OF CASH

AN EXERCISE IN CASH VALUATION

	<i>Company A</i>	<i>Company B</i>	<i>Company C</i>
Enterprise Value	\$ 1 billion	\$ 1 billion	\$ 1 billion
Cash	\$ 100 mil	\$ 100 mil	\$ 100 mil
Return on Capital	10%	5%	22%
Cost of Capital	10%	10%	12%
Trades in	US	US	Argentina

- In which of these companies is cash most likely to trade at face value, at a discount and at a premium?

CASH: DISCOUNT OR PREMIUM?

*Market Value of \$ 1 in cash:
Estimates obtained by regressing Enterprise Value against Cash Balances*

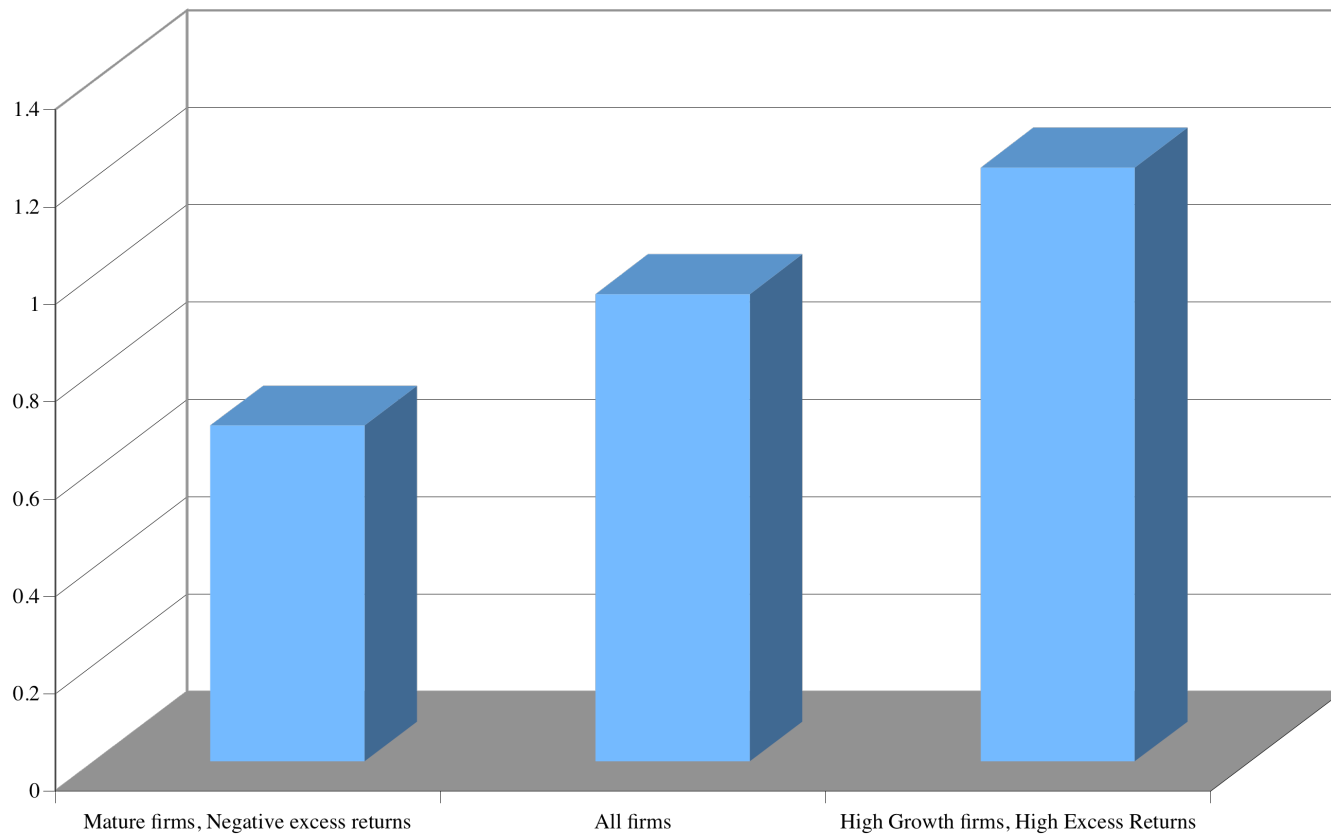

2. DEALING WITH HOLDINGS IN OTHER FIRMS

- Holdings in other firms can be categorized into
 - **Minority passive holdings**, in which case only the dividend from the holdings is shown in the balance sheet
 - **Minority active holdings**, in which case the share of equity income is shown in the income statements
 - **Majority active holdings**, in which case the financial statements are consolidated.
- We tend to be sloppy in practice in dealing with cross holdings. After valuing the operating assets of a firm, using consolidated statements, it is common to add on the balance sheet value of minority holdings (which are in book value terms) and subtract out the minority interests (again in book value terms), representing the portion of the consolidated company that does not belong to the parent company.

HOW TO VALUE HOLDINGS IN OTHER FIRMS.. IN A PERFECT WORLD..

- In a perfect world, we would strip the parent company from its subsidiaries and value each one separately. The value of the combined firm will be
 - Value of parent company + Proportion of value of each subsidiary
- To do this right, you will need to be provided detailed information on each subsidiary to estimate cash flows and discount rates.
- In addition, for firms that have dozens of cross holdings, this would require you to value all of those cross holdings to value a single company.

TWO COMPROMISE SOLUTIONS...

- **The market value solution:** When the subsidiaries are publicly traded, you could use their traded market capitalizations to estimate the values of the cross holdings. You do risk carrying into your valuation any mistakes that the market may be making in valuation.
- **The relative value solution:** When there are too many cross holdings to value separately or when there is insufficient information provided on cross holdings, you can convert the book values of holdings that you have on the balance sheet (for both minority holdings and minority interests in majority holdings) by using the average price to book value ratio of the sector in which the subsidiaries operate.

TATA MOTOR'S CROSS HOLDINGS

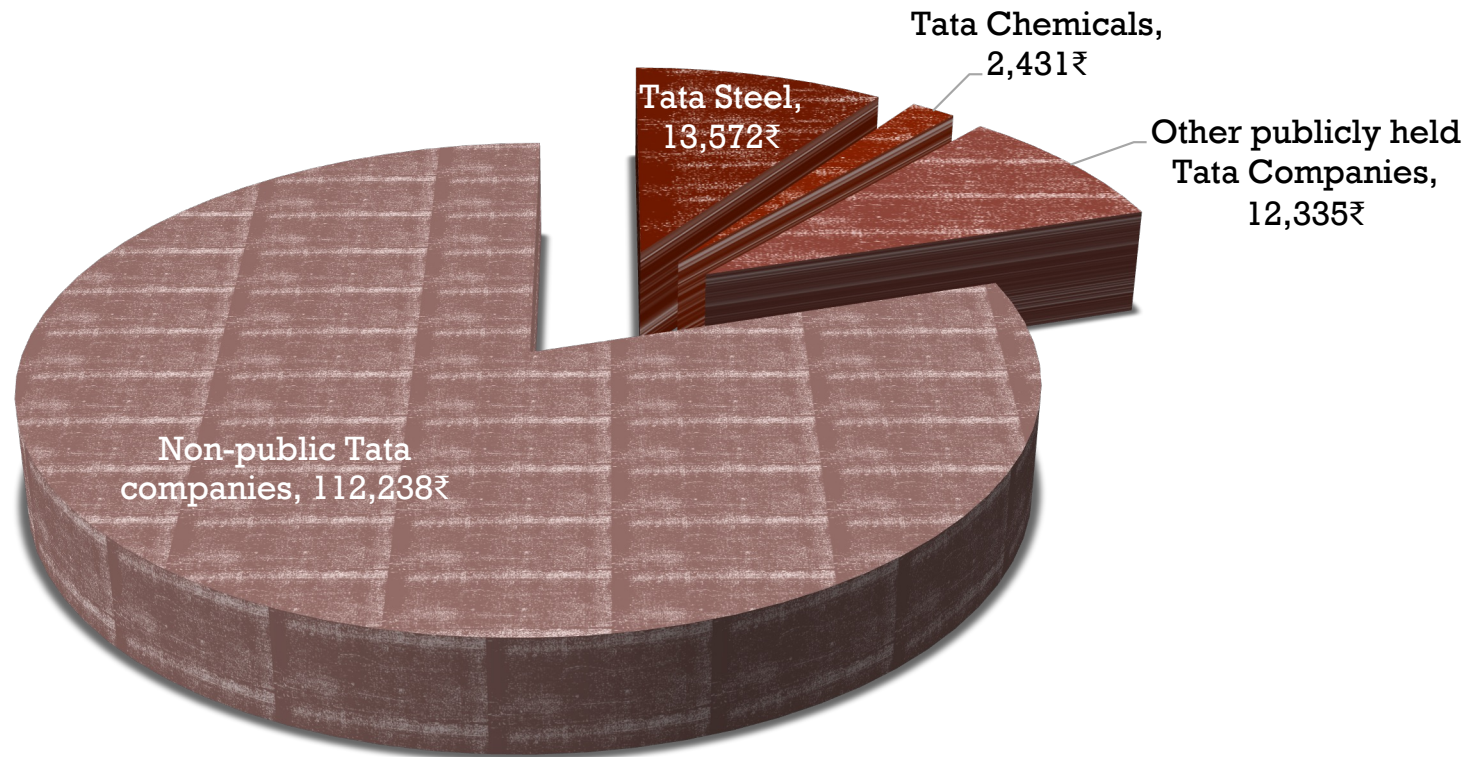

■ Tata Steel ■ Tata Chemicals ■ Other publicly held Tata Companies ■ Non-public Tata companies

3. OTHER ASSETS THAT HAVE NOT BEEN COUNTED YET..

- **Unutilized assets:** If you have assets or property that are not being utilized (vacant land, for example), you have not valued it yet. You can assess a market value for these assets and add them on to the value of the firm.
- **Overfunded pension plans:** If you have a defined benefit plan and your assets exceed your expected liabilities, you could consider the over funding with two caveats:
 - Collective bargaining agreements may prevent you from laying claim to these excess assets.
 - There are tax consequences. Often, withdrawals from pension plans get taxed at much higher rates.
- **Do not double count an asset.** If you count the income from an asset in your cash flows, you cannot count the market value of the asset in your value.

AN UNCOUNTED ASSET?

Price tag: \$200 million



The longtime home of Playboy magazine founder Hugh Hefner is to be sold to Daren Metropoulos, a principal at private-equity firm Metropoulos & Co. PHOTO: GETTY IMAGES

THE “REAL ESTATE” PLAY

- Assume that Accor Hotels, a hotel company, has real estate investments underlying its operations. Assume that you estimate a real estate value of \$1.5 billion for the real estate. Can you add this value on to your DCF value that you get for the hotel business?
 - a. Yes.
 - b. No.
 - c. Depends

- What would you do if the value of the land exceeds the present value that you have estimated for them as operating assets?
 - a. Nothing
 - b. Use the higher of the two values
 - c. Use the lower of the two values
 - d. Use a weighted average of the two values

4. A DISCOUNT FOR COMPLEXITY: AN EXPERIMENT

	<i>Company A</i>	<i>Company B</i>
Operating Income	\$ 1 billion	\$ 1 billion
Tax rate	40%	40%
ROIC	10%	10%
Expected Growth	5%	5%
Cost of capital	8%	8%
Business Mix	Single	Multiple Businesses
Holdings	Simple	Complex
Accounting	Transparent	Opaque

- Which firm would you value more highly?

MEASURING COMPLEXITY: VOLUME OF DATA IN FINANCIAL STATEMENTS

<i>Company</i>	<i>Number of pages in last 10Q</i>	<i>Number of pages in last 10K</i>
General Electric	65	410
Microsoft	63	218
Wal-mart	38	244
Exxon Mobil	86	332
Pfizer	171	460
Citigroup	252	1026
Intel	69	215
AIG	164	720
Johnson & Johnson	63	218
IBM	85	353

MEASURING COMPLEXITY: A COMPLEXITY SCORE

Item	Factors	Follow-up Question	Answer	Weighting factor	Gerdau Score	GE Score
Operating Income	1. Multiple Businesses	Number of businesses (> 10% of revenues) =	1	2.00	2	30
	2. One-time income and expenses	Percent of operating income =	10%	10.00	1	0.8
	3. Income from unspecified sources	Percent of operating income =	0%	10.00	0	1.2
	4. Items in income statement that are volatile	Percent of operating income =	15%	5.00	0.75	1
Tax Rate	1. Income from multiple locales	Percent of revenues from non-domestic locales =	70%	3.00	2.1	1.8
	2. Different tax and reporting books	Yes or No	No	Yes=3	0	3
	3. Headquarters in tax havens	Yes or No	No	Yes=3	0	0
	4. Volatile effective tax rate	Yes or No	Yes	Yes=2	2	0
Capital Expenditures	1. Volatile capital expenditures	Yes or No	Yes	Yes=2	2	2
	2. Frequent and large acquisitions	Yes or No	Yes	Yes=4	4	4
	3. Stock payment for acquisitions	Yes or No	No	Yes=4	0	4
Working capital	1. Unspecified current assets and current liabilities	Yes or No	No	Yes=3	0	0
	2. Volatile working capital items	Yes or No	Yes	Yes=2	2	2
Expected Growth rate	1. Off-balance sheet assets and liabilities	Yes or No	No	Yes=3	0	3
	2. Substantial stock buybacks	Yes or No	No	Yes=3	0	3
	3. Changing return on capital over time	Is your return on capital volatile?	Yes	Yes=5	5	5
	4. Unsustainably high return	Is your firm's ROC much higher than industry average?	No	Yes=5	0	0
Cost of capital	1. Multiple businesses	Number of businesses (more than 10% of revenues) =	1	1.00	1	20
	2. Operations in emerging markets	Percent of revenues=	50%	5.00	2.5	2.5
	3. Is the debt market traded?	Yes or No	No	No=2	2	0
	4. Does the company have a rating?	Yes or No	Yes	No=2	0	0
	5. Does the company have off-balance sheet debt?	Yes or No	No	Yes=5	0	5
No-operating assets	Minority holdings as percent of book assets	Minority holdings as percent of book assets	0%	20.00	0	0.8
Firm to Equity value	Consolidation of subsidiaries	Minority interest as percent of book value of equity	63%	20.00	12.6	1.2
Per share value	Shares with different voting rights	Does the firm have shares with different voting rights?	Yes	Yes = 10	10	0
	Equity options outstanding	Options outstanding as percent of shares	0%	10.00	0	0.25
Complexity Score =					48.95	90.55

DEALING WITH COMPLEXITY

- In Discounted Cashflow Valuation
 - **The Aggressive Analyst:** Trust the firm to tell the truth and value the firm based upon the firm's statements about their value.
 - **The Conservative Analyst:** Don't value what you cannot see.
 - **The Compromise:** Adjust the value for complexity
 - Adjust cash flows for complexity
 - Adjust the discount rate for complexity
 - Adjust the expected growth rate/ length of growth period
 - Value the firm and then discount value for complexity
- In relative valuation
 - In a relative valuation, you may be able to assess the price that the market is charging for complexity:
 - With the hundred largest market cap firms, for instance:
 - $PBV = 0.65 + 15.31 \text{ ROE} - 0.55 \text{ Beta} + 3.04 \text{ Expected growth rate} - 0.003 \text{ \# Pages in 10K}$

5. THE VALUE OF SYNERGY

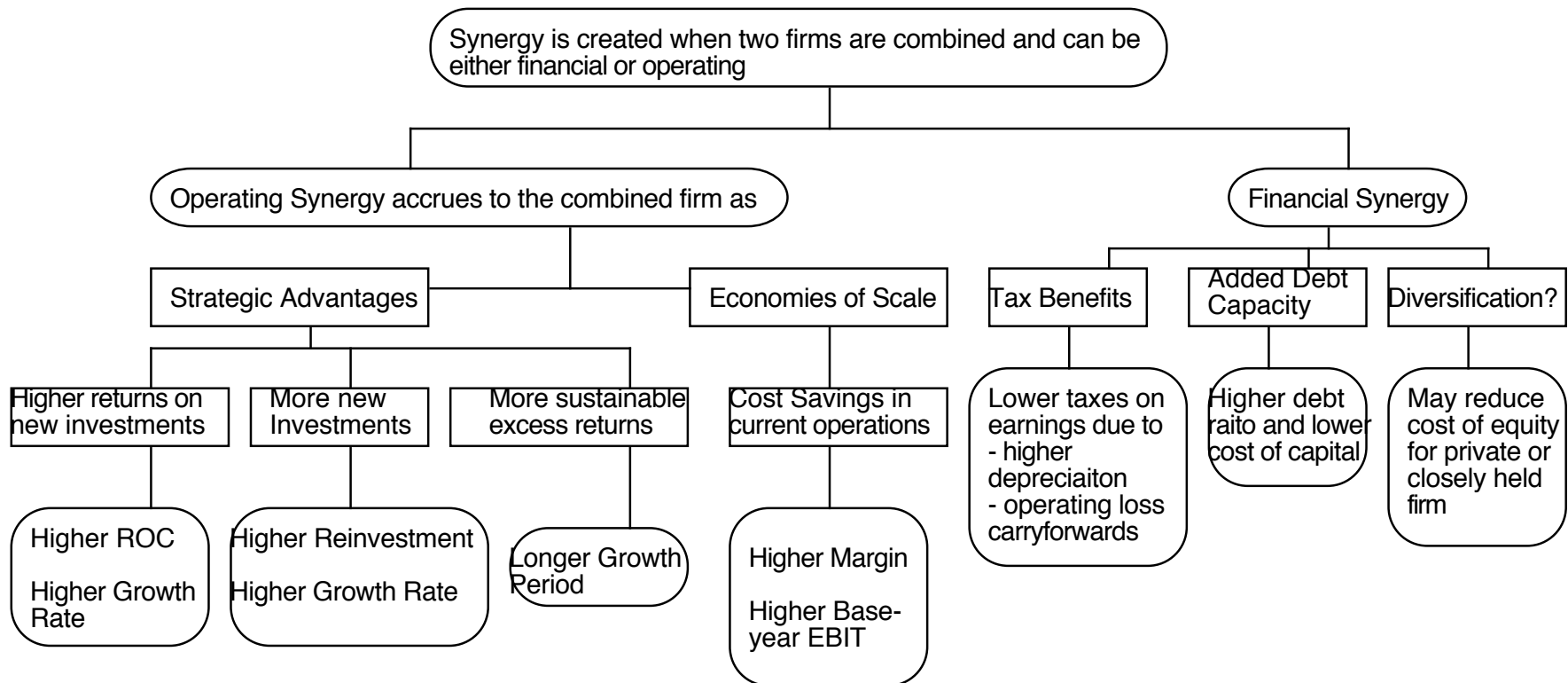

VALUING SYNERGY

(1) The firms involved in the merger are valued independently, by discounting expected cash flows to each firm at the weighted average cost of capital for that firm.

(2) The value of the combined firm, with no synergy, is obtained by adding the values obtained for each firm in the first step.

(3) The effects of synergy are built into expected growth rates and cashflows, and the combined firm is re-valued with synergy.

- Value of Synergy = Value of the combined firm, with synergy - Value of the combined firm, without synergy

INBEV + SAB MILLER: WHERE'S THE SYNERGY?

	<i>Inbev</i>	<i>SABMiller</i>	<i>Combined firm (status quo)</i>	<i>Combined firm (synergy)</i>
Levered Beta	0.85	0.8289	0.84641	0.84641
Pre-tax cost of debt	3.0000%	3.2000%	3.00%	3.00%
Effective tax rate	18.00%	26.36%	19.92%	19.92%
Debt to Equity Ratio	30.51%	23.18%	29.71%	29.71%
Revenues	\$45,762.00	\$22,130.00	\$67,892.00	\$67,892.00
Operating Margin	32.28%	19.97%	28.27%	30.00%
Operating Income (EBIT)	\$14,771.97	\$4,419.36	\$19,191.33	\$20.368
After-tax return on capital	12.10%	12.64%	11.68%	12.00%
Reinvestment Rate =	50.99%	33.29%	43.58%	50.00%
Expected Growth Rate	6.17%	4.21%	5.09%	6.00%

THE VALUE OF SYNERGY

	<i>Inbev</i>	<i>SABMiller</i>	<i>Combined firm (status quo)</i>	<i>Combined firm (synergy)</i>
Cost of Equity =	8.93%	9.37%	9.12%	9.12%
After-tax cost of debt =	2.10%	2.24%	2.10%	2.10%
Cost of capital =	7.33%	8.03%	7.51%	7.51%
After-tax return on capital =	12.10%	12.64%	11.68%	12.00%
Reinvestment Rate =	50.99%	33.29%	43.58%	50.00%
Expected growth rate=	6.17%	4.21%	5.09%	6.00%
<i>Value of firm</i>				
PV of FCFF in high growth =	\$28,733	\$9,806	\$38,539	\$39,151
Terminal value =	\$260,982	\$58,736	\$319,717	\$340,175
Value of operating assets =	\$211,953	\$50,065	\$262,018	\$276,610

Value of synergy = 276,610 – 262,018 = 14,592 million

6. BRAND NAME, GREAT MANAGEMENT, SUPERB PRODUCT ...ARE WE SHORT CHANGING INTANGIBLES?

- There is often a temptation to add on premiums for intangibles. Here are a few examples.
 - Brand name
 - Great management
 - Loyal workforce
 - Technological prowess
- There are two potential dangers:
 - For some assets, the value may already be in your value and adding a premium will be double counting.
 - For other assets, the value may be ignored but incorporating it will not be easy.

A SINGLE INTANGIBLE: VALUING BRAND NAME AT COCA COLA

	<i>Coca Cola</i>	<i>With Cott Margins</i>
Current Revenues =	\$21,962.00	\$21,962.00
Length of high-growth period	10	10
Reinvestment Rate =	50%	50%
Operating Margin (after-tax)	15.57%	5.28%
Sales/Capital (Turnover ratio)	1.34	1.34
Return on capital (after-tax)	20.84%	7.06%
Growth rate during period (g) =	10.42%	3.53%
Cost of Capital during period =	7.65%	7.65%
Stable Growth Period		
Growth rate in steady state =	4.00%	4.00%
Return on capital =	7.65%	7.65%
Reinvestment Rate =	52.28%	52.28%
Cost of Capital =	7.65%	7.65%
Value of Firm =	\$79,611.25	\$15,371.24

MULTIPLE INTANGIBLES: VALUING BIRKENSTOCK'S MANY INTANGIBLES!

- **Brand Name:** It is undeniable that Birkenstock not only has a brand name, in terms of recognition and visibility, but has the pricing power and operating margins to back up that brand name.
- **Celebrity Customer Base:** Birkenstock attracts celebrities in different age groups, from Gwyneth Paltrow & Heidi Klum to Paris Jackson & Kendall Jenner, and more impressively, it does so without paying them sponsorship fees. If the best advertising is unsolicited, Birkenstock clearly has mastered the game.
- **Good Management:** Birkenstock seems to have struck gold with Oliver Reichert. Not only has he steered the company towards high growth, but he has done so without upsetting the balance that lies behind its brand name.
- **The Barbie Buzz:** Margot Robbie's pink Birkenstock sandals in that movie, which has been the blockbuster hit of the year, hypercharged the demand for the company's footwear. It is true that buzzes fade, but not before they create a revenue bump and perhaps even increase the customer base for the long term.

Birkenstock IPO Valuation												Sep-23		
Base Year and Comparison			Growth Story			Profitability Story			Growth Efficiency Story			Terminal Value		
	Company	Big Apparel	Growth of 25% in year 1, followed by 15% in years 2-5			Operating margin of 23% in year 1, rising to 25% over the following four years.			Set to third quartile (2.62) of big brand apparel & footwear firms.			Growth Rate	2.74%	
CAGR in Revenues (2013-22)	18.20%	8.66%	Barbie Buzz in year 1. Strong management finds growth in new markets/products, without sacrificing brand name.			Brand name allows for preservation & slight growth in strong profit margins.			Free celebrity advertising and more sponsorship deals will allow for more efficient reinvestment.			Cost of capital	7.74%	
Revenue (LTM)	€ 1,439,976											Return on capital	12.00%	
Operating Margin (LTM)	22.31%	14.74%										Reinvestment Rate	22.83%	
Operating Income	€ 321,230													
EBIT (1-t)	€ 224,861													
PV(Terminal value)	€ 6,087,285		1	2	3	4	5	6	7	8	9	10	Terminal year	
PV (CF over next 10 years)	€ 2,862,595		Revenue Growth	25.00%	15.00%	15.00%	15.00%	15.00%	12.55%	10.10%	7.64%	5.19%	2.74%	2.74%
Probability of failure =	0.00%		Revenue	€ 1,799,970	€ 2,069,966	€ 2,380,460	€ 2,737,529	€ 3,148,159	€ 3,543,190	€ 3,900,910	€ 4,199,096	€ 4,417,113	€ 4,538,142	€ 4,662,487
Value of operating assets =	€ 8,949,880		Operating Margin	23.00%	23.80%	24.20%	24.60%	25.00%	25.00%	25.00%	25.00%	25.00%	25.00%	25.00%
- Debt	€ 1,874,002		Operating Income	€ 413,993	€ 492,652	€ 576,071	€ 673,432	€ 787,040	€ 885,797	€ 975,228	€ 1,049,774	€ 1,104,278	€ 1,134,535	€ 1,165,622
- Minority interests	€ -		EBIT (1-t)	€ 289,795	€ 344,856	€ 403,250	€ 471,403	€ 550,928	€ 620,058	€ 682,659	€ 734,842	€ 772,995	€ 794,175	€ 815,935
+ Cash	€ 307,078		Reinvestment	€ 103,052	€ 118,509	€ 136,286	€ 156,729	€ 150,775	€ 136,535	€ 113,811	€ 83,213	€ 46,194	€ 47,460	€ 186,305
+ Non-operating assets	€ -		FCFF	€ 186,743	€ 226,347	€ 266,964	€ 314,674	€ 400,153	€ 483,524	€ 568,848	€ 651,629	€ 726,801	€ 746,715	€ 629,630
Value of equity	€ 8,382,956												€ 12,592,600	
- Value of options	€ -													
Value of equity (common stock)	€ 8,382,956		Cost of Capital	7.45%	7.45%	7.45%	7.45%	7.45%	7.51%	7.57%	7.63%	7.68%	7.74%	
Number of shares	202,853.00		Cumulated WACC	0.9306	0.8661	0.8060	0.7501	0.6980	0.6493	0.6036	0.5608	0.5208	0.4834	
Estimated value /share	€ 41.33													
			Sales to Capital	2.62	2.62	2.62	2.62	2.62	2.62	2.62	2.62	2.62	2.62	
Price per share	€ 46.50		ROIC	7.38%	8.56%	9.73%	11.01%	12.41%	13.51%	14.44%	15.18%	15.70%	15.98%	12.00%
% Under or Over Valued	12.52%													
			Risk Story			Competitive Advantages								
			Cost of capital reflecting business mix, geography & debt policy.			Competitive advantages will persist.								
			Centering production in Germany reduces supply chain & country risk.			Intangibles collectively sustain a return on capital above the cost of capital.								

BIRKENSTOCK: INTANGIBLES IN VALUE

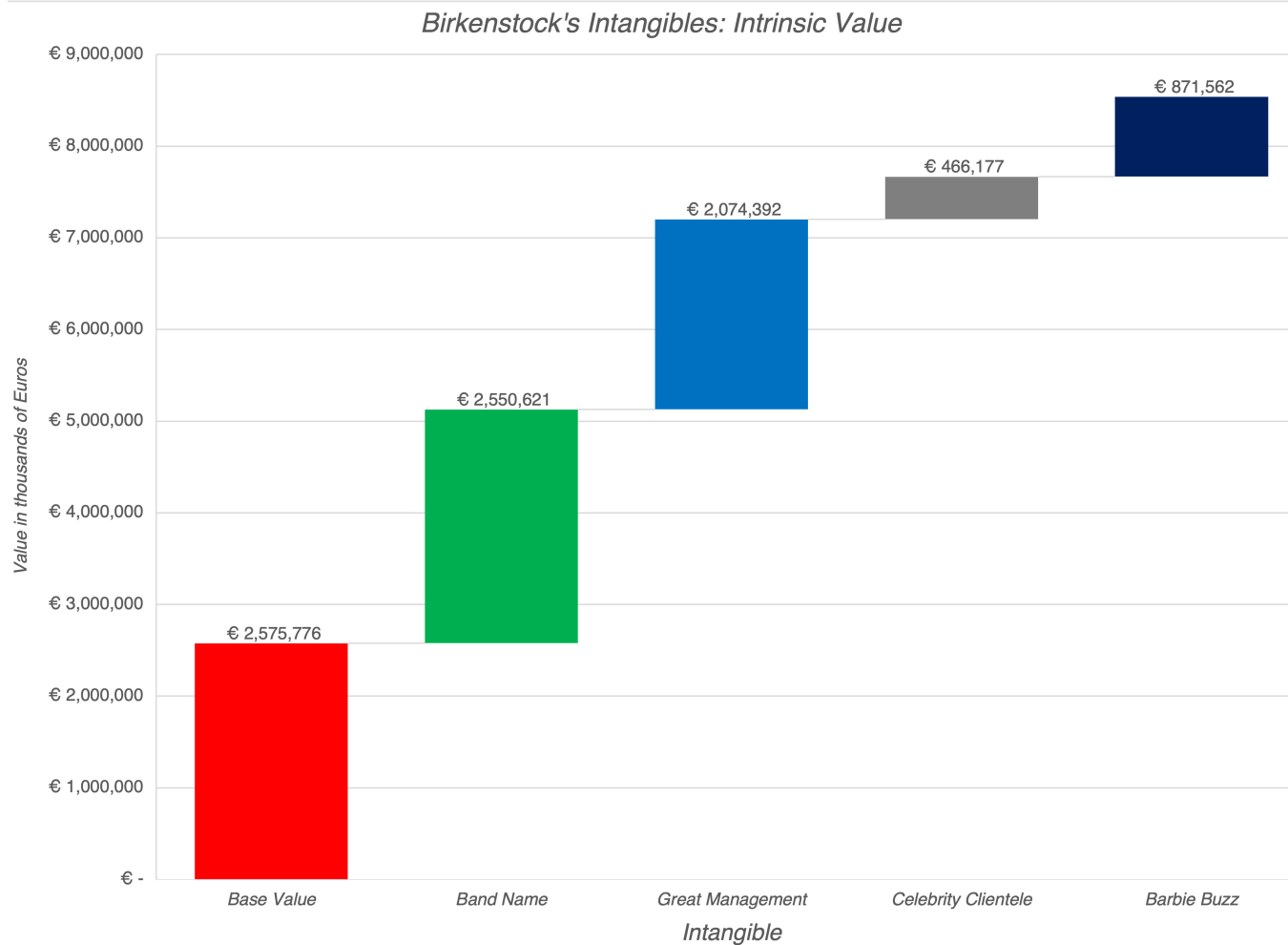

VALUING A FRANCHISE: STAR WARS

Star Wars Franchise Valuation: December 2015

	Add-on \$ per Box Office \$
Streaming/Video	\$1.20
Toys & Merchandise	\$2.00
Books/eBooks	\$0.20
Gaming	\$0.50
Other	\$0.50

Main Movies
World Box office of \$1.5 billion,
adjusted for 2% inflation.

Spin Off Movies
World Box office is 50% of
main movies.

Add on \$ per box office \$	Main Star Wars Movies			Star Wars Spin offs			
	Star Wars VII	Star Wars VIII	Star Wars IX	Rogue One	Hans Solo?	Boba Fett?	
Years from now	0.0	2.0	4.0	1.0	3.0	5.0	
Movies - Revenues	\$2,000	\$2,081	\$2,165	\$1,020	\$1,061	\$1,104	
Streaming/Video - Revenues	\$2,400	\$2,497	\$2,598	\$1,224	\$1,273	\$1,325	
Toys & Merchandise - Revenues	\$4,000	\$4,162	\$4,330	\$2,040	\$2,122	\$2,208	
Books/eBooks - Revenues	\$400	\$416	\$433	\$204	\$212	\$221	
Gaming - Revenues	\$1,000	\$1,040	\$1,082	\$510	\$531	\$552	
Other - Revenues	\$1,000	\$1,040	\$1,082	\$510	\$531	\$552	
Total - Revenues	\$10,800	\$11,236	\$11,690	\$5,508	\$5,731	\$5,962	
Operating Margin 20.14% for movies 15% for non-movies 30% tax rate	After-tax Operating Income (movies)	\$ 282	\$ 293	\$ 305	\$ 144	\$ 150	\$ 156
	After-tax Operating Income (non-movies)	\$ 924	\$ 961	\$ 1,000	\$ 471	\$ 490	\$ 510
	Present Value	\$ 1,206	\$ 1,083	\$ 973	\$ 572	\$ 514	\$ 461
Discounted back @ 7.61% cost of capital of entertainment companies	Value of new Star Wars movies =	\$4,809					
	Value of continuing income =	\$5,163					
	Value of Star Wars =	\$9,972					

Assumes that revenues from add ons
continue after 2020, growing at 2% a year,
with 15% operating margin

7. BE CIRCUMSPECT ABOUT DEFINING DEBT FOR COST OF CAPITAL PURPOSES...

- **General Rule:** Debt generally has the following characteristics:
 - **Contractual commitment** to make fixed payments in the future
 - The fixed payments are **tax deductible**
 - Failure to make the payments can lead to **either default or loss of control of the firm** to the party to whom payments are due.
- Defined as such, debt should include
 - All interest bearing liabilities, short term as well as long term
 - All leases, operating as well as capital
- Debt should not include
 - Accounts payable or supplier credit, since neither explicitly requires interest payment.

BUT SHOULD CONSIDER OTHER POTENTIAL LIABILITIES WHEN GETTING TO EQUITY VALUE...

- If you have **under funded pension fund or health care plans**, you should consider the under funding at this stage in getting to the value of equity.
 - If you do so, you should not double count by also including a cash flow line item reflecting cash you would need to set aside to meet the unfunded obligation.
 - You should not be counting these items as debt in your cost of capital calculations....
- If you have **contingent liabilities** - for example, a potential liability from a lawsuit that has not been decided - you should consider the expected value of these contingent liabilities
 - Value of contingent liability = Probability that the liability will occur
* Expected value of liability

8. THE VALUE OF CONTROL

- The value of the control premium that will be paid to acquire a block of equity will depend upon two factors -
 - **Probability that control of firm will change:** This refers to the probability that incumbent management will be replaced. this can be either through acquisition or through existing stockholders exercising their muscle.
 - **Value of Gaining Control of the Company:** The value of gaining control of a company arises from two sources - the increase in value that can be wrought by changes in the way the company is managed and run, and the side benefits and perquisites of being in control
 - *Value of Gaining Control = Present Value (Value of Company with change in control - Value of company without change in control) + Side Benefits of Control*

Changing Value

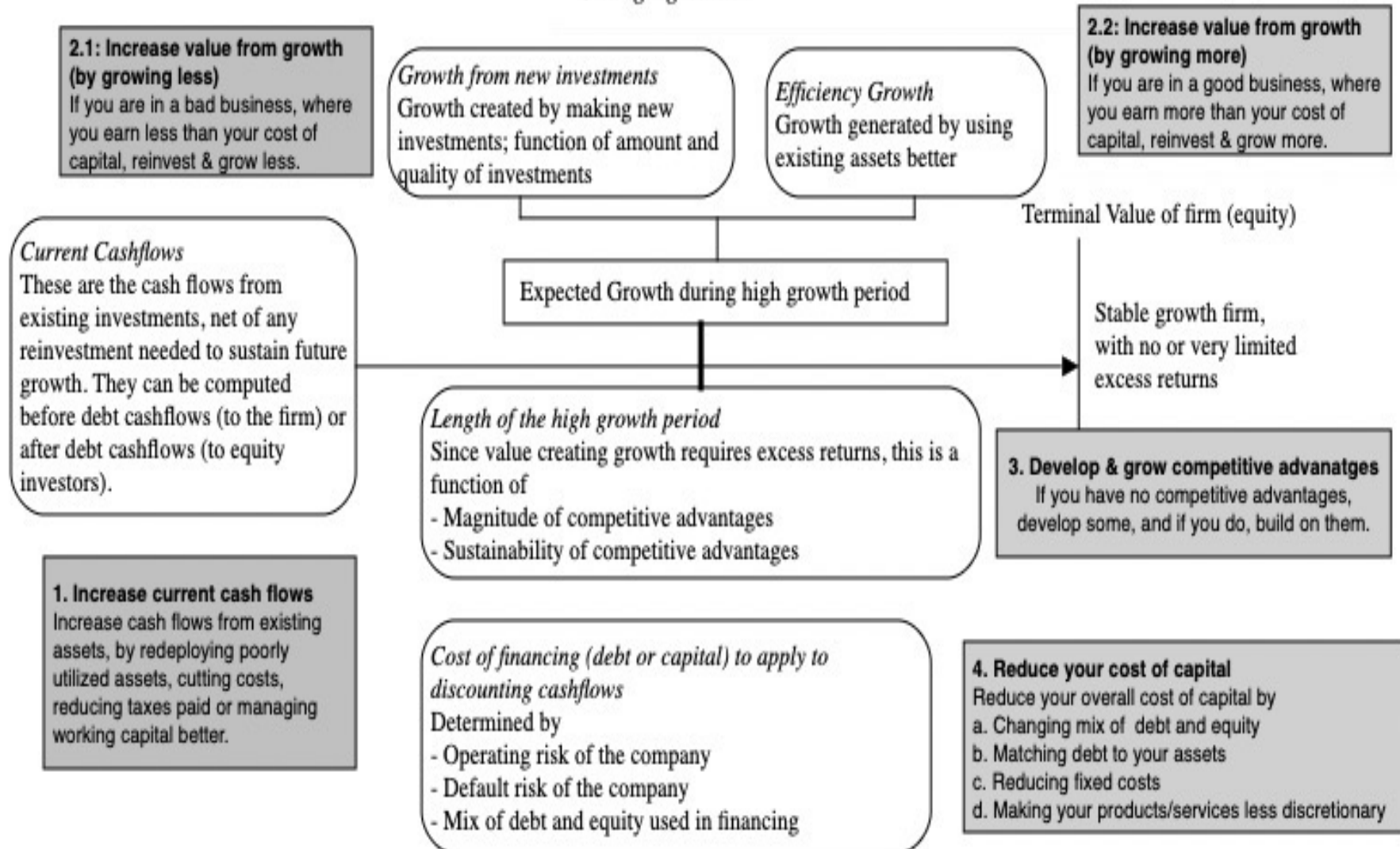

Adris Grupa (Status Quo): 4/2010

Current Cashflow to Firm
 EBIT(1-t) : 436 HRK
 - Nt CpX 3 HRK
 - Chg WC -118 HRK
 = FCFF 551 HRK
 Reinv Rate = $(3-118)/436 = -26.35\%$;
 Tax rate = 17.35%
 Return on capital = 8.72%

Average from 2004-09
 70.83%

Reinvestment Rate
 70.83%

Expected Growth from new inv.
 $.7083 \times .0969 = 0.0686$
 or 6.86%

Average from 2004-09
 9.69%

Return on Capital
 9.69%

Stable Growth
 $g = 4\%$; Beta = 0.80
 Country Premium = 2%
 Cost of capital = 9.92%
 Tax rate = 20.00%
 ROC = 9.92%;
 Reinvestment Rate = $g/ROC = 4/9.92 = 40.32\%$

Terminal Value₅ = $365 / (.0992 - .04) = 6170$ HRK

Op. Assets 4312
 + Cash: 1787
 - Debt 141
 - Minority int 465
 = Equity 5,484
 / (Common + Preferred shares)
 Value non-voting share 335 HRK/share

Year	1	2	3	4	5	
EBIT (1-t)	HRK 466	HRK 498	HRK 532	HRK 569	HRK 608	612 246 365
- Reinvestment	HRK 330	HRK 353	HRK 377	HRK 403	HRK 431	
FCFF	HRK 136	HRK 145	HRK 155	HRK 166	HRK 177	

Discount at \$ Cost of Capital (WACC) = 10.7% (.974) + 5.40% (0.026) = 10.55%

On May 1, 2010
 AG Pfd price = 279 HRK
 AG Common = 345 HRK

Cost of Equity
 10.70%

Cost of Debt
 $(4.25\% + 0.5\% + 2\%)(1 - .20) = 5.40\%$

Weights
 E = 97.4% D = 2.6%

Riskfree Rate:
 HRK Riskfree Rate = 4.25%

Beta 0.70
 x
 Mature market premium 4.5%

Unlevered Beta for Sectors: 0.68
 Firm's D/E Ratio: 2.70%

Lambda 0.68 x CRP for Croatia (3%)
 Lambda 0.42 x CRP for Central Europe (3%)
 Country Default Spread 2% x Rel Equity Mkt Vol 1.50

Adris Grupa: 4/2010 (Restructured)

Current Cashflow to Firm
 EBIT(1-t) : 436 HRK
 - Nt CpX 3 HRK
 - Chg WC -118 HRK
 = FCFF 551 HRK
 Reinv Rate= (3-118)/436=-26.35%;
 Tax rate = 17.35%
 Return on capital = 8.72%

Increased ROIC to cost of capital

Reinvestment Rate
70.83%

Expected Growth from new inv.
 $.7083 \times .01054 = 0.0747$
 or 7.47%

Return on Capital
10.54%

Stable Growth
 g = 4%; Beta = 0.80
 Country Premium= 2%
 Cost of capital = 9.65%
 Tax rate = 20.00%
 ROC=9.65%;
 Reinvestment Rate=g/ROC
 =4/9.65%= 41.47%

Terminal Value₅ = $367 / (.0965 - .04) = 6508$ HRK

Op. Assets 4545
 + Cash: 1787
 - Debt 141
 - Minority int 465
 =Equity 5,735
 Value/non-voting 334
 Value/voting 362

Year	1	2	3	4	5	
EBIT (1-t)	HRK 469	HRK 503	HRK 541	HRK 581	HRK 623	
- Reinvestment	HRK 332	HRK 356	HRK 383	HRK 411	HRK 442	
FCFF	HRK 137	HRK 147	HRK 158	HRK 169	HRK 182	
						628 246 367

Discount at \$ Cost of Capital (WACC) = $11.12\% (.90) + 8.20\% (0.10) = 10.54\%$

Changed mix of debt and equity to optimal

Cost of Equity
11.12%

Cost of Debt
 $(4.25\% + 4\% + 2\%) (1 - .20) = 8.20\%$

Weights
E = 90 % D = 10 %

On May 1, 2010
 AG Pfd price = 279 HRK
 AG Common = 345 HRK

Riskfree Rate:
HRK Riskfree Rate= 4.25%

Beta 0.75 X Mature market premium 4.5%

Lambda 0.68 X CRP for Croatia (3%)
 Lambda 0.42 X CRP for Central Europe (3%)

Unlevered Beta for Sectors: 0.68

Firm's D/E Ratio: 11.1%

Country Default Spread 2%

Rel Equity Mkt Vol 1.50

VALUE OF CONTROL AND THE VALUE OF VOTING RIGHTS

- Adris Grupa has **two classes of shares outstanding**: 9.616 million voting shares and 6.748 million non-voting shares.
 - To value a non-voting share, we assume that all non-voting shares essentially have to settle for status quo value. All shareholders, common and preferred, get an equal share of the status quo value.

Status Quo Value of Equity = 5,484 million HKR

Value for a non-voting share = $5484 / (9.616 + 6.748)$

= 334 HKR/share

- To value a voting share, we **first value control** in Adris Grupa as the difference between the optimal and the status quo value:
 - Value of control at Adris Grupa = $5,735 - 5484 = 249$ million HKR
 - Value per voting share = $334 \text{ HKR} + 249 / 9.616 = 362$ HKR



INTRINSIC VALUATION: THE DARK SIDE

Valuing difficult-to-value companies!

Aswath Damodaran

THE FUNDAMENTAL DETERMINANTS OF VALUE...

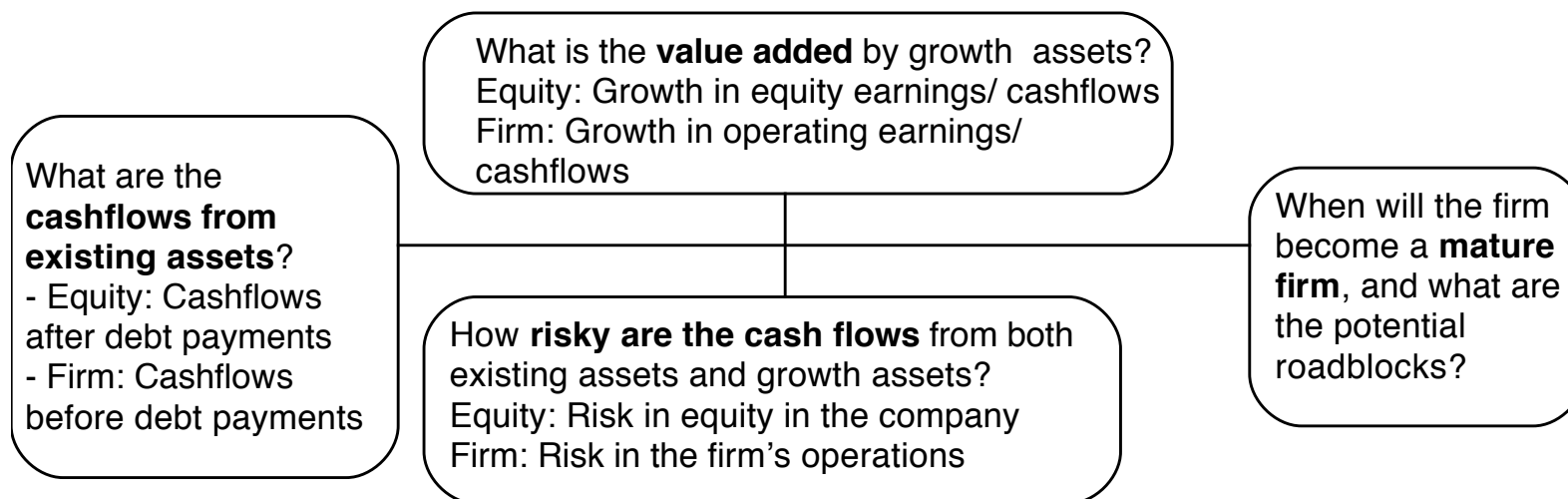

THE DARK SIDE OF VALUATION...

- Valuing **stable, money making companies** with consistent and clear accounting statements, a long and stable history and lots of comparable firms is easy to do.
- The true test of your valuation skills is when you have to value “difficult” companies. In particular, the challenges are greatest when valuing:
 - **Young companies**, early in the life cycle, in young businesses
 - Companies that **don't fit the accounting mold**
 - Companies that **face substantial truncation risk** (default or nationalization risk)

DIFFICULT TO VALUE COMPANIES . . .

- Across the life cycle:
 - **Young, growth firms:** Limited history, small revenues in conjunction with big operating losses and a propensity for failure make these companies tough to value.
 - **Mature companies in transition:** When mature companies change or are forced to change, history may have to be abandoned and parameters have to be reestimated.
 - **Declining and Distressed firms:** A long but irrelevant history, declining markets, high debt loads and the likelihood of distress make them troublesome.
- Across sectors
 - **Financial service firms:** Opacity of financial statements and difficulties in estimating basic inputs leave us trusting managers to tell us what's going on.
 - **Commodity and cyclical firms:** Dependence of the underlying commodity prices or overall economic growth make these valuations susceptible to macro factors.
 - **Firms with intangible assets:** Accounting principles are left to the wayside on these firms.
- Across the ownership cycle
 - **Privately owned businesses:** Exposure to firm specific risk and illiquidity bedevil valuations.
 - **Venture Capital (VC) and private equity:** Different equity investors, with different perceptions of risk.
 - **Closely held public firms:** Part private and part public, sharing the troubles of both.

I. THE CHALLENGE WITH YOUNG COMPANIES...

Figure 5.2: Estimation Issues - Young and Start-up Companies

Making judgments on revenues/ profits difficult because you cannot draw on history. If you have no product/ service, it is difficult to gauge market potential or profitability. The company's entire value lies in future growth but you have little to base your estimate on.

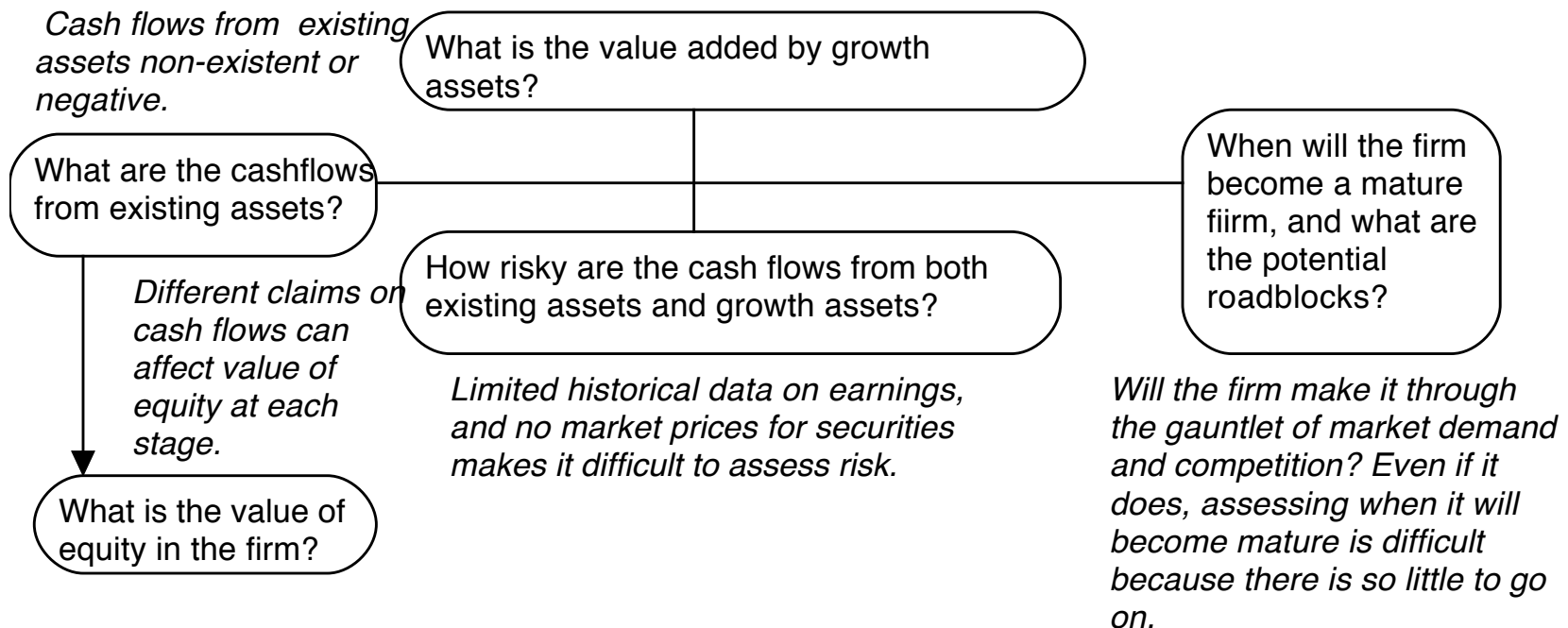

UPPING THE ANTE.. YOUNG COMPANIES IN YOUNG BUSINESSES...

- When valuing a business, we generally draw on three sources of information
 - The firm's **current financial statement**
 - How much did the firm sell?
 - How much did it earn?
 - The firm's **financial history**, usually summarized in its financial statements.
 - How fast have the firm's revenues and earnings grown over time?
 - What can we learn about cost structure and profitability from these trends?
 - Susceptibility to macro-economic factors (recessions and cyclical firms)
 - The industry and **peer firm data**
 - What happens to firms as they mature? (Margins.. Revenue growth... Reinvestment needs... Risk)
- It is when valuing these companies that you find yourself tempted by the dark side, where
 - "Paradigm shifts" happen...
 - New metrics are invented ...
 - The story dominates and the numbers lag...

Amazon in January 2000

Drivers of Cash Flow (Business Model)

Stable Growth

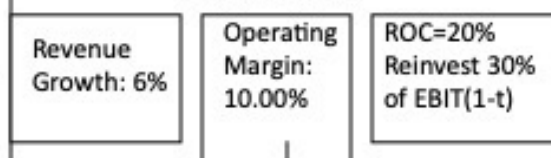

Terminal Value = $1881 / (.0961 - .06) = 52,148$

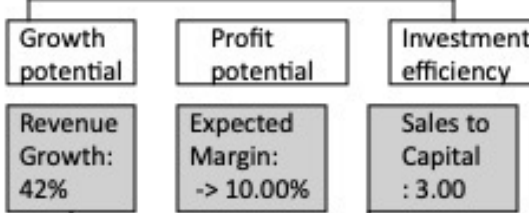
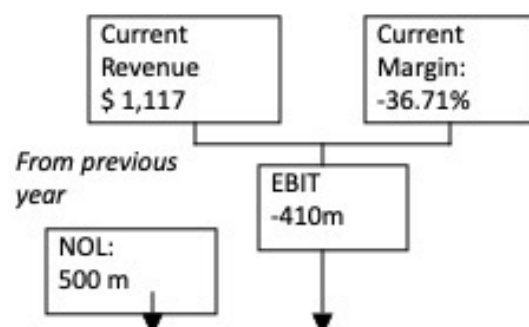

Value of Op Assets \$ 15,170
+ Cash \$ 26
= Value of Firm \$ 15,196
- Value of Debt \$ 349
= Value of Equity \$ 14,847
- Equity Options \$ 2,892
Value per share \$ 35.08

	Base	1	2	3	4	5	6	7	8	9	10	Terminal Year
Revenue Growth Rate	150.00%	100.00%	75.00%	50.00%	30.00%	25.20%	20.40%	15.60%	10.80%	6.00%	6%	6%
Revenues	\$ 1,117	\$ 2,793	\$ 5,585	\$ 9,774	\$ 14,661	\$ 19,059	\$ 23,862	\$ 28,729	\$ 33,211	\$ 36,798	\$ 39,006	\$ 41,346
Operating Margin	-36.71%	-13.35%	-1.68%	4.16%	7.08%	8.54%	9.27%	9.64%	9.82%	9.91%	9.95%	10.00%
EBIT	-\$410	-\$373	-\$94	\$407	\$1,038	\$1,628	\$2,212	\$2,768	\$3,261	\$3,646	\$3,883	\$4,135
Taxes	\$0	\$0	\$0	\$0	\$167	\$570	\$774	\$969	\$1,141	\$1,276	\$1,359	\$1,447
EBIT(1-t)	-\$410	-\$373	-\$94	\$407	\$871	\$1,058	\$1,438	\$1,799	\$2,119	\$2,370	\$2,524	\$2,688
- Reinvestment	\$133	\$559	\$931	\$1,396	\$1,629	\$1,466	\$1,601	\$1,623	\$1,494	\$1,196	\$736	\$806
FCFF	-\$543	-\$931	-\$1,024	-\$989	-\$758	-\$408	-\$163	\$177	\$625	\$1,174	\$1,788	\$1,881

	1	2	3	4	5	6	7	8	9	10	Forever
Cost of Equity	12.90%	12.90%	12.90%	12.90%	12.90%	12.42%	11.94%	11.46%	10.98%	10.50%	
Cost of Debt	8.00%	8.00%	8.00%	8.00%	8.00%	7.80%	7.75%	7.67%	7.50%	7.00%	
After-tax cost of debt	8.00%	8.00%	8.00%	6.71%	5.20%	5.07%	5.04%	4.98%	4.88%	4.55%	
Cost of Capital	12.84%	12.84%	12.84%	12.83%	12.81%	12.13%	11.62%	11.08%	10.49%	9.61%	

All existing options valued as options, using current stock price of \$84.

Amazon was trading at \$84 in January 2000.

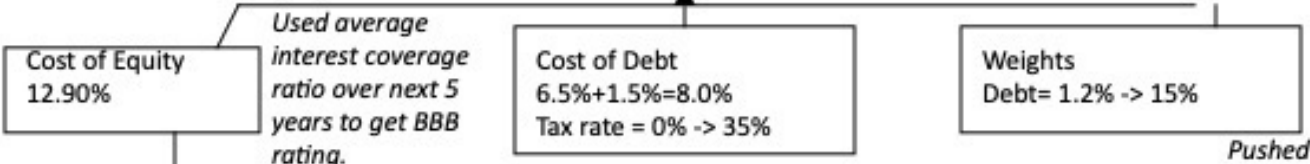

Pushed debt ratio to retail industry average of 15%.

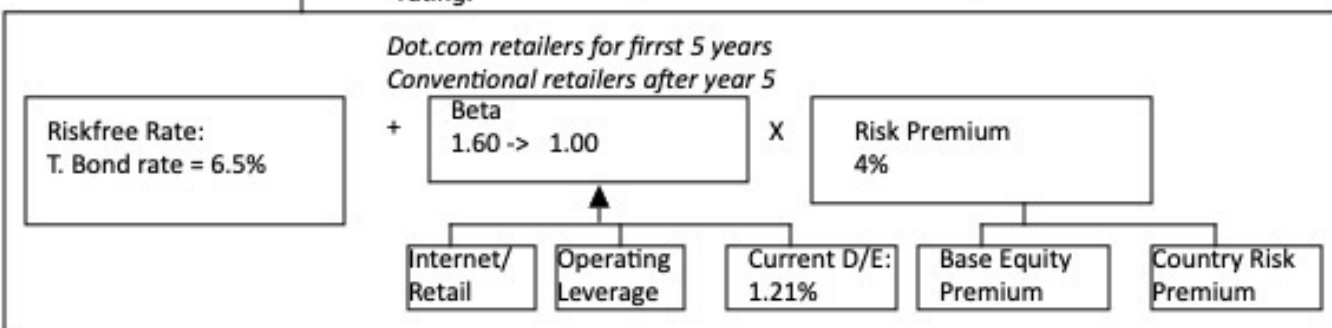

LESSON 1: DON'T TRUST REGRESSION BETAS....

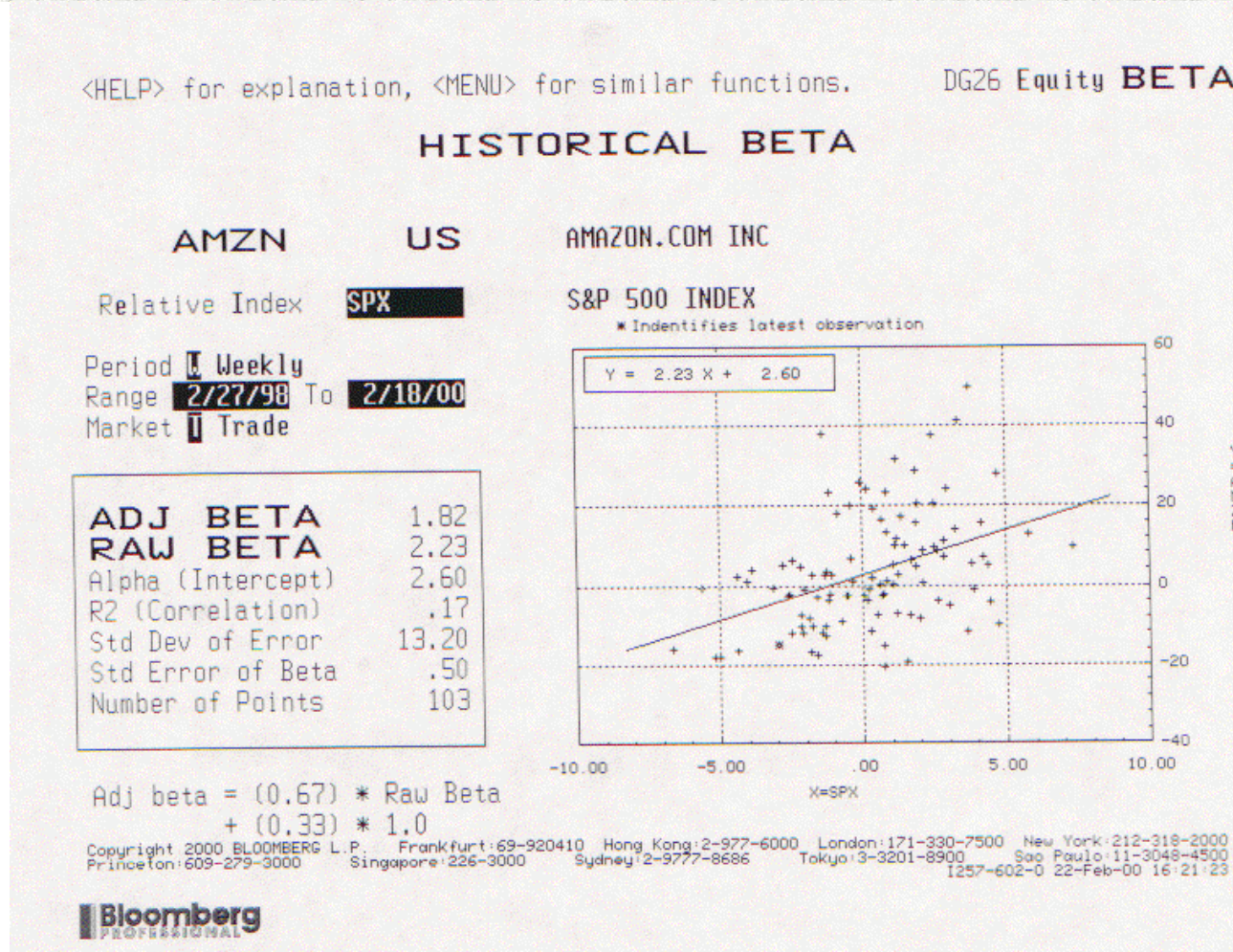

LESSON 2: WORK BACKWARDS AND KEEP IT SIMPLE...

Year	Revenue Growth	Sales	Operating Margin	EBIT	EBIT (1-t)
Tr 12 mths		\$1,117	-36.71%	-\$410	-\$410
1	150.00%	\$2,793	-13.35%	-\$373	-\$373
2	100.00%	\$5,585	-1.68%	-\$94	-\$94
3	75.00%	\$9,774	4.16%	\$407	\$407
4	50.00%	\$14,661	7.08%	\$1,038	\$871
5	30.00%	\$19,059	8.54%	\$1,628	\$1,058
6	25.20%	\$23,862	9.27%	\$2,212	\$1,438
7	20.40%	\$28,729	9.64%	\$2,768	\$1,799
8	15.60%	\$33,211	9.82%	\$3,261	\$2,119
9	10.80%	\$36,798	9.91%	\$3,646	\$2,370
10	6.00%	\$39,006	9.95%	\$3,883	\$2,524
TY	6.00%	\$41,346	10.00%	\$4,135	\$2,688

LESSON 3: SCALING UP IS HARD TO DO...

Typically, the revenue growth rate of a newly public company outpaces its industry average for only about five years.

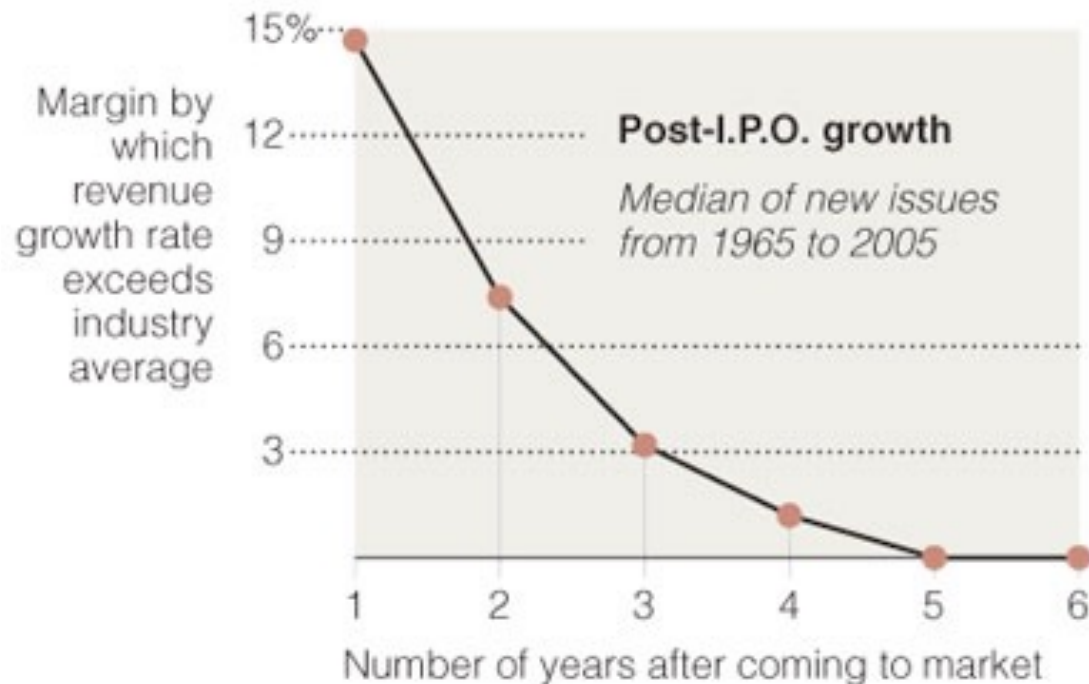

Source: Andrew Metrick

The New York Times

LESSON 4: DON'T FORGET TO PAY FOR GROWTH...

Invested Capital in year t = Invested Capital in year t-1 + Reinvestment in year t-1

Year	Revenues	Δ Revenue	Sales/Cap	Δ Investment	Invested Capital	EBIT (1-t)	Imputed ROC
Tr 12 mths	\$1,117				\$ 487	-\$410	
1	\$2,793	\$1,676	3.00	\$559	\$ 1,045	-\$373	-76.62%
2	\$5,585	\$2,793	3.00	\$931	\$ 1,976	-\$94	-8.96%
3	\$9,774	\$4,189	3.00	\$1,396	\$ 3,372	\$407	20.59%
4	\$14,661	\$4,887	3.00	\$1,629	\$ 5,001	\$871	25.82%
5	\$19,059	\$4,398	3.00	\$1,466	\$ 6,467	\$1,058	21.16%
6	\$23,862	\$4,803	3.00	\$1,601	\$ 8,068	\$1,438	22.23%
7	\$28,729	\$4,868	3.00	\$1,623	\$ 9,691	\$1,799	22.30%
8	\$33,211	\$4,482	3.00	\$1,494	\$ 11,185	\$2,119	21.87%
9	\$36,798	\$3,587	3.00	\$1,196	\$ 12,380	\$2,370	21.19%
10	\$39,006	\$2,208	3.00	\$736	\$ 13,116	\$2,524	20.39%
TY	\$41,346	\$2,340	NA		Assumed to be =		20.00%

Return on Capital in year t = EBIT (1-t) in year t / Invested Capital in year t-1

LESSON 5: THERE ARE ALWAYS SCENARIOS WHERE THE MARKET PRICE CAN BE JUSTIFIED...

		Target pre-tax Operating Margin				
		6%	8%	10%	12%	14%
Compounded annual Revenue Growth rate	30%	\$ (1.94)	\$ 2.95	\$ 7.84	\$ 12.71	\$ 17.57
	35%	\$ 1.41	\$ 8.37	\$ 15.33	\$ 22.27	\$ 29.21
	40%	\$ 6.10	\$ 15.93	\$ 25.74	\$ 35.54	\$ 45.34
	45%	\$ 12.59	\$ 26.34	\$ 40.05	\$ 53.77	\$ 67.48
	50%	\$ 21.47	\$ 40.50	\$ 59.52	\$ 78.53	\$ 97.54
	55%	\$ 33.47	\$ 59.60	\$ 85.72	\$ 111.84	\$ 137.95
	60%	\$ 49.53	\$ 85.10	\$ 120.66	\$ 156.22	\$ 191.77

LESSON 6: YOU WILL BE WRONG 100% OF THE TIME... AND IT REALLY IS NOT (ALWAYS) YOUR FAULT...

- No matter how careful you are in getting your inputs and how well structured your model is, **your estimate of value will change** both as new information comes out about the company, the business and the economy.
- As information comes out, you will have to **adjust and adapt your model to reflect the information**. Rather than be defensive about the resulting changes in value, recognize that this is the essence of risk.
- A test: **If your valuations are unbiased**, you should find yourself increasing estimated values as often as you are decreasing values. In other words, there should be equal doses of good and bad news affecting valuations (at least over time).

AND THE MARKET IS OFTEN "MORE WRONG"

Amazon: Value and Price

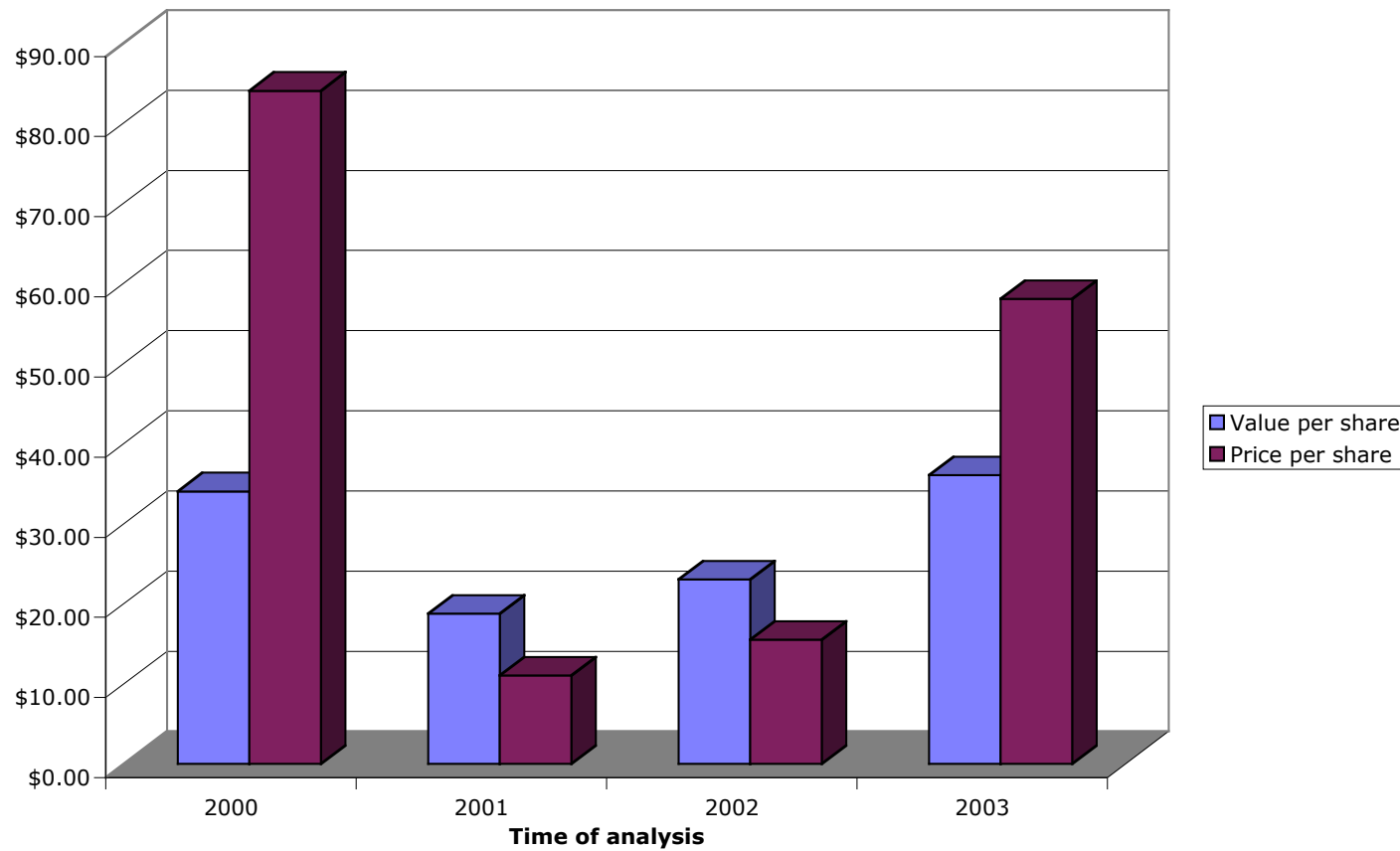

VALUING AN IPO

- Valuation issues:
 - **Use of the proceeds from the offering:** The proceeds from the offering can be held as cash by the firm to cover future investment needs, paid to existing equity investors who want to cash out or used to pay down debt.
 - **Warrants/ Special deals with prior equity investors:** If venture capitalists and other equity investors from earlier iterations of fund raising have rights to buy or sell their equity at pre-specified prices, it can affect the value per share offered to the public.
- Pricing issues:
 - **Institutional set-up:** Most IPOs are backed by investment banking guarantees on the price, which can affect how they are priced.
 - **Follow-up offerings:** The proportion of equity being offered at initial offering and subsequent offering plans can affect pricing.

Zomato						Jul-21
The Story						
Zomato will benefit as the Indian food delivery market grows, driven by overall economic growth and more digital access, and it will be one of a few (two or three) players who will dominate the market; there will be a near term COVID bounceback effect. While Amazon Food remains the wild card, economies of scales will allow the company to generate high operating margins, and the company will continue to reinvest (acquisitions and technology) as it grows. The risk of failure is low, given the company's post-IPO cash balance and access to capital and its operating risk reflects its exposure to Indian country risk.						
The Assumptions						
	<i>Base year</i>	<i>Next year</i>	<i>Years 2-5</i>	<i>Years 6-10</i>	<i>After year 10</i>	<i>Link to story</i>
Indian Food Delivery	₹ 225,000	₹ 337,500	30.00%	15.27%	₹ 1,961,979	Indian food market rebounds in 2021 and grows to about \$25 billion in year 10
Market Share	42.15%	41.72%	→	40.00%	40.00%	Zomato is one of two or three lead players in Indian food delivery market
Revenues as % of GOV	21.03%	22.00%			22.00%	
Revenues (a)	₹ 19,937.89	₹ 30,975	Total Market * Market Share* Revenue as % of GOV		₹ 172,654	COVID rebound in 2021 + Growth in food delivery market in India long term
Operating margin (b)	-24.10%	-10.0%	-10.00%	→ 35.00%	35.00%	Margins improve as growth wanes
Tax rate	30.00%		30.00%	→ 30.00%	30.00%	Indian corporate tax rate over time
Reinvestment (c)		5.00	2.50	3.00	35.42%	Acquisitions & technology investments needed to sustain growth
Return on capital	-7.15%	Marginal ROIC =	127.01%		12.00%	Newworking benefits allow for high ROIC, near and long term.
Cost of capital (d)			10.25%	→ 8.97%	8.97%	Cost of capital reflects Indian country risk
The Cash Flows						
	<i>Total Market</i>	<i>Market Share</i>	<i>Revenues</i>	<i>EBIT (1-t)</i>	<i>Reinvestment</i>	<i>FCFF</i>
1	₹ 337,500	41.72%	₹ 30,974.78	-₹ 3,097.48	₹ 2,207.38	-₹ 5,304.86
2	₹ 438,750	41.29%	₹ 39,852.91	₹ 498.16	₹ 3,551.25	-₹ 3,053.09
3	₹ 570,375	40.86%	₹ 51,270.19	₹ 3,247.17	₹ 4,566.91	-₹ 1,319.74
4	₹ 741,488	40.43%	₹ 65,951.07	₹ 5,770.72	₹ 5,872.35	-₹ 101.64
5	₹ 963,934	40.00%	₹ 84,826.17	₹ 10,762.32	₹ 6,291.70	₹ 4,470.62
6	₹ 1,203,471	40.00%	₹ 105,905.47	₹ 14,994.01	₹ 7,026.43	₹ 7,967.57
7	₹ 1,440,555	40.00%	₹ 126,768.85	₹ 24,503.10	₹ 6,954.46	₹ 17,548.64
8	₹ 1,650,156	40.00%	₹ 145,213.72	₹ 35,577.36	₹ 6,148.29	₹ 29,429.07
9	₹ 1,805,271	40.00%	₹ 158,863.81	₹ 38,921.63	₹ 4,550.03	₹ 34,371.60
10	₹ 1,881,995	40.00%	₹ 165,615.52	₹ 40,575.80	₹ 2,250.57	₹ 38,325.23
Terminal year	₹ 1,961,979	40.00%	₹ 172,654.18	₹ 42,300.27	₹ 14,981.35	₹ 27,318.93
The Value						
Terminal value			₹ 578,790.83			
PV(Terminal value)			₹ 225,869.40			
PV (CF over next 10 years)			₹ 50,979.90			
Value of operating assets =			₹ 276,849.30			
Adjustment for distress			₹ 13,842.46	Probability of failure =		10.00%
- Debt & Minority Interests			₹ 1,591.72			
+ Cash & Other Non-operating assets			₹ 135,959.70	Includes cash proceeds from IPO of		₹ 90,000
Value of equity			₹ 397,374.81			
- Value of equity options			₹ 73,244.53			
Number of shares			7,946.68			
Value per share			₹ 40.79	Stock was offered at =		₹ 70.00

II. DEALING WITH DECLINE AND DISTRESS...

Historical data often reflects flat or declining revenues and falling margins. Investments often earn less than the cost of capital.

Growth can be negative, as firm sheds assets and shrinks. As less profitable assets are shed, the firm's remaining assets may improve in quality.

What is the value added by growth assets?

What are the cashflows from existing assets?

Underfunded pension obligations and litigation claims can lower value of equity. Liquidation preferences can affect value of equity

What is the value of equity in the firm?

How risky are the cash flows from both existing assets and growth assets?

Depending upon the risk of the assets being divested and the use of the proceeds from the divestiture (to pay dividends or retire debt), the risk in both the firm and its equity can change.

When will the firm become a mature firm, and what are the potential roadblocks?

There is a real chance, especially with high financial leverage, that the firm will not make it. If it is expected to survive as a going concern, it will be as a much smaller entity.

DEALING WITH THE “DOWNSIDE” OF DISTRESS

- **A DCF valuation values a firm as a going concern.** If there is a significant likelihood of the firm failing before it reaches stable growth and if the assets will then be sold for a value less than the present value of the expected cash flows (a distress sale value), DCF valuations will understate the value of the firm.

$$\text{Value of Equity} = \text{DCF value of equity} (1 - \text{Probability of distress}) + \text{Distress sale value of equity} (\text{Probability of distress})$$

- There are three ways in which we can estimate the probability of distress:
 - **Use the bond rating** to estimate the cumulative probability of distress over 10 years
 - Estimate the probability of distress **with a probit**
 - Estimate the probability of distress by looking at market value of bonds..
- The distress sale value of equity is usually best estimated as a percent of book value (and this value will be lower if the economy is doing badly and there are other firms in the same business also in distress).

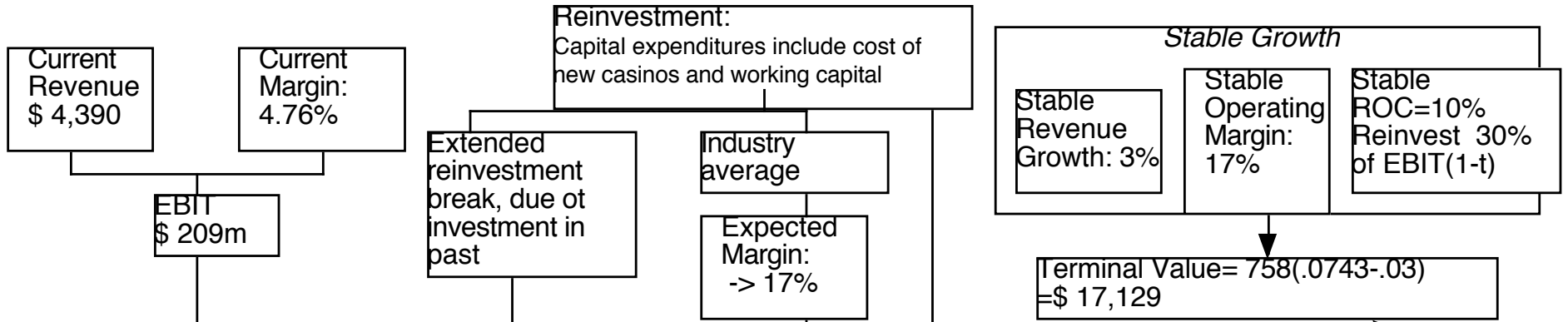

Revenues	\$4,434	\$4,523	\$5,427	\$6,513	\$7,815	\$8,206	\$8,616	\$9,047	\$9,499	\$9,974	Term. Year
Oper margin	5.81%	6.86%	7.90%	8.95%	10%	11.40%	12.80%	14.20%	15.60%	17%	\$10,273
EBIT	\$258	\$310	\$429	\$583	\$782	\$935	\$1,103	\$1,285	\$1,482	\$1,696	17%
Tax rate	26.0%	26.0%	26.0%	26.0%	26.0%	28.4%	30.8%	33.2%	35.6%	38.00%	38%
EBIT * (1 - t)	\$191	\$229	\$317	\$431	\$578	\$670	\$763	\$858	\$954	\$1,051	\$1,083
- Reinvestment	-\$19	-\$11	\$0	\$22	\$58	\$67	\$153	\$215	\$286	\$350	\$ 325
FCFF	\$210	\$241	\$317	\$410	\$520	\$603	\$611	\$644	\$668	\$701	\$758

Value of Op Assets \$ 9,793
 + Cash & Non-op \$ 3,040
 = Value of Firm \$12,833
 - Value of Debt \$ 7,565
 = Value of Equity \$ 5,268

Value per share \$ 8.12

	1	2	3	4	5	6	7	8	9	10	Forever
Beta	3.14	3.14	3.14	3.14	3.14	2.75	2.36	1.97	1.59	1.20	
Cost of equity	21.82%	21.82%	21.82%	21.82%	21.82%	19.50%	17.17%	14.85%	12.52%	10.20%	
Cost of debt	9%	9%	9%	9%	9%	8.70%	8.40%	8.10%	7.80%	7.50%	
Debt/ratio	73.50%	73.50%	73.50%	73.50%	73.50%	68.80%	64.10%	59.40%	54.70%	50.00%	
Cost of capital	9.88%	9.88%	9.88%	9.88%	9.88%	9.79%	9.50%	9.01%	8.32%	7.43%	

Cost of Equity 21.82%

Cost of Debt 3%+6%= 9%
 9% (1-.38)=5.58%

Weights Debt= 73.5% ->50%

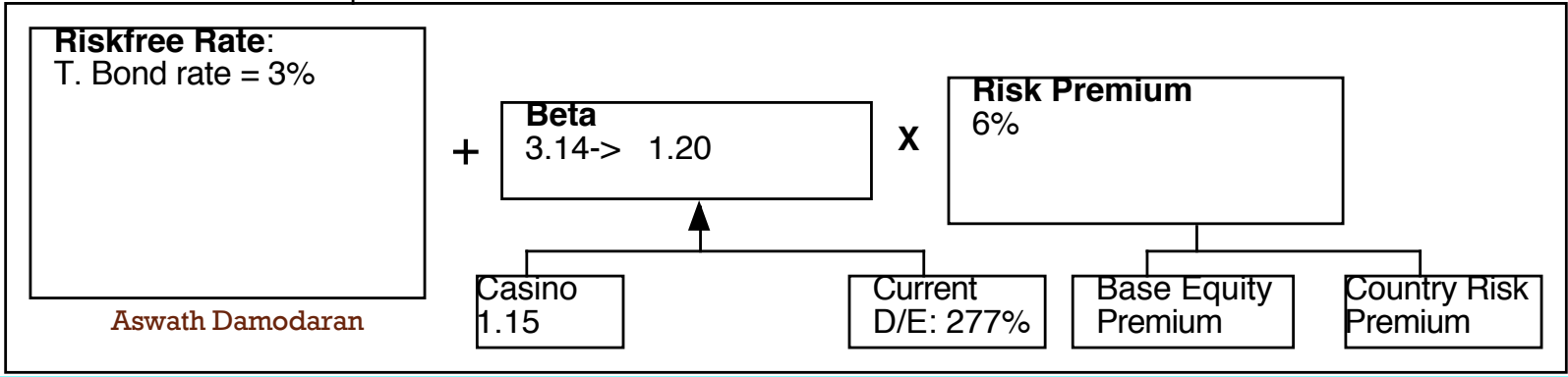

Las Vegas Sands
Feburary 2009
Trading @ \$4.25

ADJUSTING THE VALUE OF LVS FOR DISTRESS..

- **Ratings based approach:** In February 2009, Las Vegas Sands was rated B+, and based upon history (previous ten years), the likelihood of default is 28.25%.
- **Bond Price based:** In February 2009, LVS was rated B+ by S&P. Historically, 28.25% of B+ rated bonds default within 10 years. LVS has a 6.375% bond, maturing in February 2015 (7 years), trading at \$529. If we discount the expected cash flows on the bond at the riskfree rate, we can back out the probability of distress

$$529 = \sum_{t=1}^{t=7} \frac{63.75(1 - \pi_{\text{Distress}})^t}{(1.03)^t} + \frac{1000(1 - \pi_{\text{Distress}})^7}{(1.03)^7}$$

π_{Distress} = Annual probability of default = 13.54%

Cumulative probability of surviving 10 years = $(1 - .1354)^{10} = 23.34\%$

Cumulative probability of distress over 10 years = $1 - .2334 = .7666$ or 76.66%

- If LVS is becomes distressed:
 - Expected distress sale proceeds = \$2,769 million < Face value of debt
 - Expected equity value/share = \$0.00
- Expected value per share
 - With ratings-based approach: $\$8.12 (.7175) + \$0 (.2825) = \$5.83$
 - With bond-based approach: $\$8.12 (1 - .7666) + \$0.00 (.7666) = \$1.92$

THE "SUNNY" SIDE OF DISTRESS: EQUITY AS A CALL OPTION TO LIQUIDATE THE FIRM

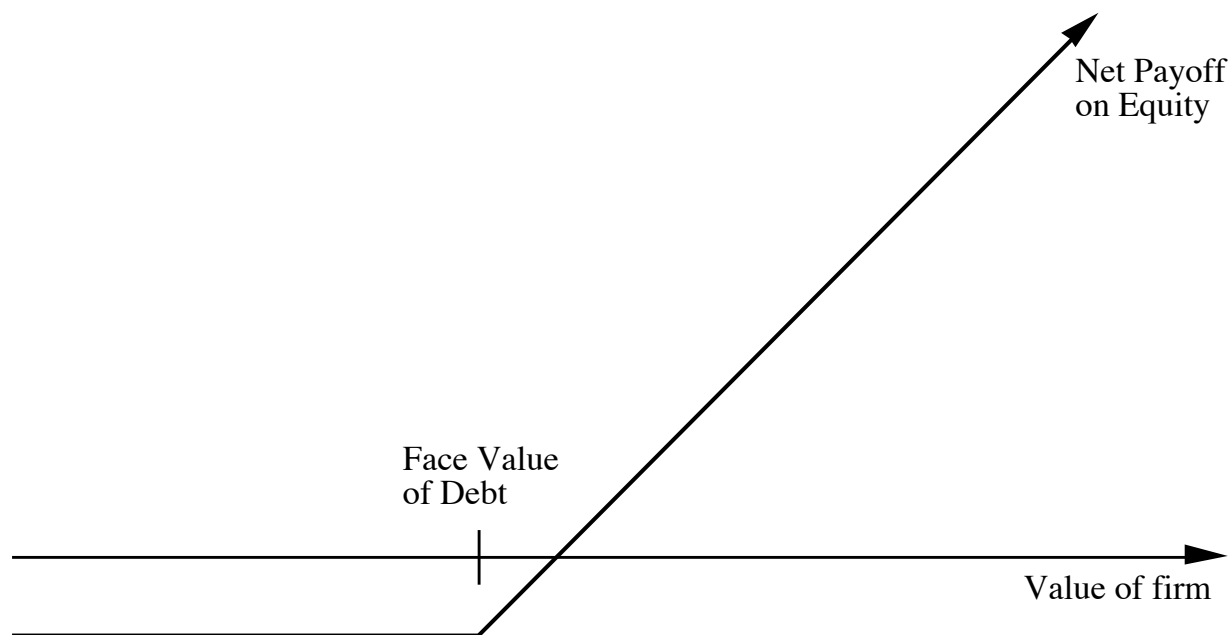

APPLICATION TO VALUATION: A SIMPLE EXAMPLE

- Assume that you have a firm whose assets are currently valued at \$100 million and that the standard deviation in this asset value is 40%.
- Further, assume that the face value of debt is \$80 million (It is zero coupon debt with 10 years left to maturity).
- If the ten-year treasury bond rate is 10%,
 - how much is the equity worth?
 - What should the interest rate on debt be?

MODEL PARAMETERS & VALUATION

- The inputs
 - Value of the underlying asset = S = Value of the firm = \$ 100 million
 - Exercise price = K = Face Value of outstanding debt = \$ 80 million
 - Life of the option = t = Life of zero-coupon debt = 10 years
 - Variance in the value of the underlying asset = σ^2 = Variance in firm value = 0.16
 - Riskless rate = r = Treasury bond rate corresponding to option life = 10%
- The output
 - The Black-Scholes model provides the following value for the call:
 $d1 = 1.5994$ $N(d1) = 0.9451$
 $d2 = 0.3345$ $N(d2) = 0.6310$
 - Value of the call (equity) = $100 (0.9451) - 80 \exp(-0.10)(10) (0.6310) =$
 \$75.94 million
 - Value of the outstanding debt = $\$100 - \$75.94 = \$24.06$ million
 - Interest rate on debt = $(\$ 80 / \$24.06)^{1/10} - 1 = 12.77\%$

FIRM VALUE DROPS..

- Assume now that a catastrophe wipes out half the value of this firm (the value drops to \$ 50 million), while the face value of the debt remains at \$ 80 million.
- The inputs
 - Value of the underlying asset = S = Value of the firm = \$ 50 million
 - All the other inputs remain unchanged
- The output
 - Based upon these inputs, the Black-Scholes model provides the following value for the call:
 - $d1 = 1.0515$ $N(d1) = 0.8534$
 - $d2 = -0.2135$ $N(d2) = 0.4155$
 - Value of the call = $50 (0.8534) - 80 \exp(-0.10)(10) (0.4155) = \30.44 million
 - Value of the bond = $\$50 - \$30.44 = \$19.56$ million

EQUITY VALUE PERSISTS .. AS FIRM VALUE DECLINES..

Value of Equity as Firm Value Changes

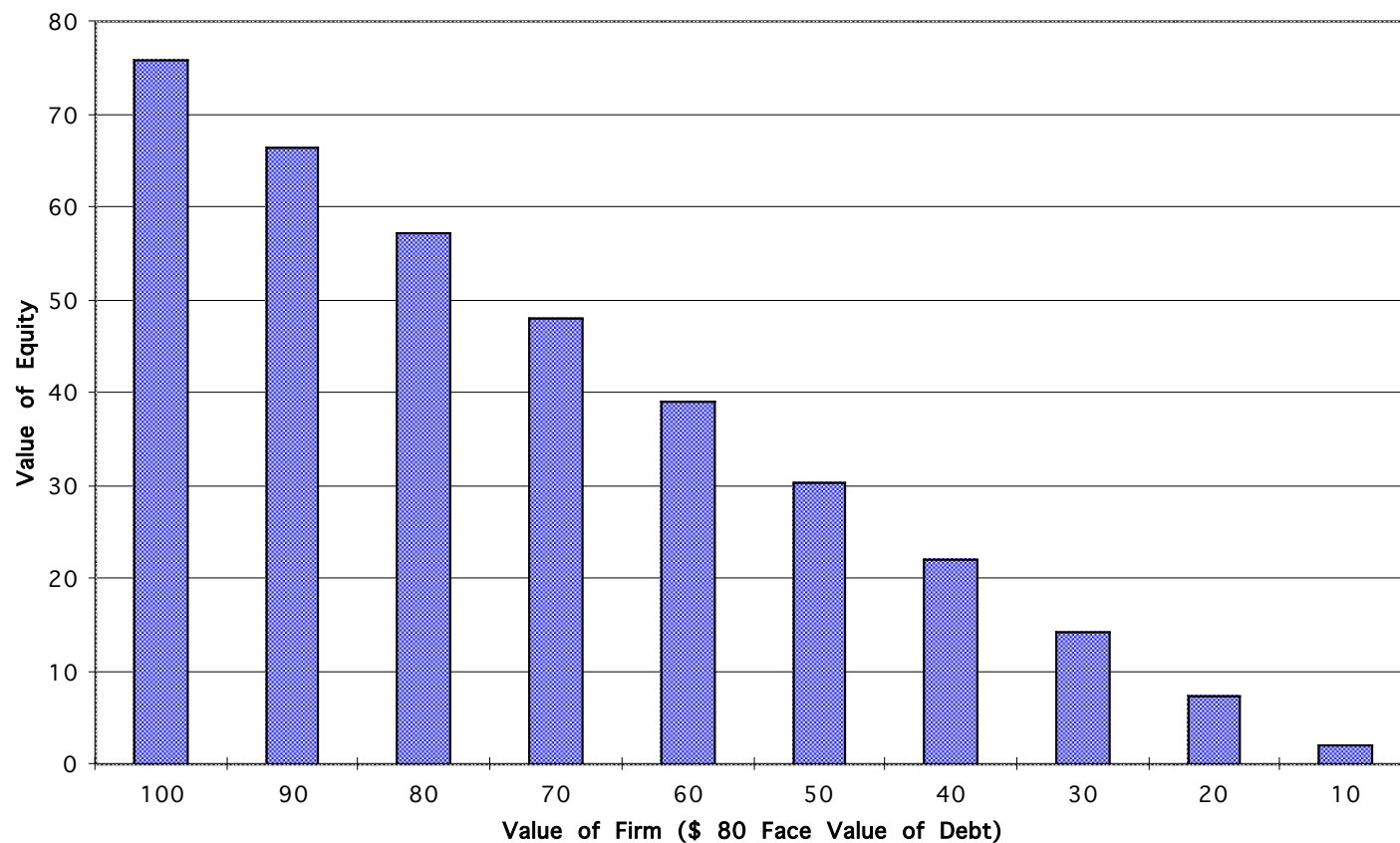

III. VALUING FINANCIAL SERVICE COMPANIES

Existing assets are usually financial assets or loans, often marked to market. Earnings do not provide much information on underlying risk.

What are the cashflows from existing assets?

Preferred stock is a significant source of capital.

What is the value of equity in the firm?

Defining capital expenditures and working capital is a challenge. Growth can be strongly influenced by regulatory limits and constraints. Both the amount of new investments and the returns on these investments can change with regulatory changes.

What is the value added by growth assets?

How risky are the cash flows from both existing assets and growth assets?

For financial service firms, debt is raw material rather than a source of capital. It is not only tough to define but if defined broadly can result in high financial leverage, magnifying the impact of small operating risk changes on equity risk.

When will the firm become a mature firm, and what are the potential roadblocks?

In addition to all the normal constraints, financial service firms also have to worry about maintaining capital ratios that are acceptable of regulators. If they do not, they can be taken over and shut down.

LESSON 1: DEBT TO A BANK IS RAW MATERIAL, NOT A SOURCE OF CAPITAL

- With conventional firms, you often face a choice of either valuing the entire business (using cash flows to the firm and a cost of capital) or valuing equity. Often, valuing the firm is both easier and more robust, and you subtract out debt to get to value of equity.
- With financial service firms, valuing the firm is often a non-starter, since debt to a bank is not a source of capital but raw material.
- Status Quo 1: When you value a bank, it is almost always on an equity basis.

LESSON 2: ESTIMATING CASH FLOWS FOR A BANK IS DIFFICULT TO DO..

- Assuming that you want to go down the road of valuing equity using a DCF, the standard definition of cash flows is
 - $FCFE = \text{Net Income} + \text{Depreciation} - \text{Cap Ex} - \text{Change in Non-cash Working Capital}$
- Defining cap ex and working capital for a bank is close to impossible. Consequently, most analysts give up and make one of the two following choices:
 - The indefensible: Discount earnings at the cost of equity, which gives you basically nothing.
 - The defensible: Discount dividends at the cost of equity
- Status Quo 2: The dividend discount model's last stand was with financial service companies.

LESSON 3: FOR FINANCIAL SERVICE COMPANIES, BOOK VALUE MATTERS...

- The book value of assets and equity is mostly irrelevant when valuing non-financial service companies. After all, the book value of equity is a historical figure and can be nonsensical. (The book value of equity can be negative and is so for more than a 1000 publicly traded US companies)
- With financial service firms, book value of equity is relevant for two reasons:
 - Since financial service firms mark to market, the book value is more likely to reflect what the firms own right now (rather than a historical value)
 - The regulatory capital ratios are based on book equity. Thus, a bank with negative or even low book equity will be shut down by the regulators.
- From a valuation perspective, it therefore makes sense to pay heed to book value. In fact, you can argue that reinvestment for a bank is the amount that it needs to add to book equity to sustain its growth ambitions and safety requirements:
 - $FCFE = \text{Net Income} - \text{Reinvestment in regulatory capital (book equity)}$

Stodgy and Low-profitability Bank, with investment potential

Citi has fallen behind its biggest rivals on growth and profitability, and investors have built in their low regard for it into its pricing. In my story, Ciit will continue on its cautious path of low growth, while earning a return on equity that is well below its cost of equity, but it is well capitalized (even with the write downs on investment securities that may be coming) and continues to earn a lucrative spread on its core banking business.

	Current	1	2	3	4	5	Steady state	Estimation notes
Risk Adjusted Assets	\$1,142,985	\$1,177,275	\$1,212,593	\$1,248,971	\$1,286,440	\$1,325,033	\$1,364,784	Grows 3% a year in perpetuity
Tier 1 Capital ratio	14.80%	14.84%	14.88%	14.92%	14.96%	15.00%	15.00%	Improves to 15% over 5 years
Tier 1 Capital	\$169,145	\$174,694	\$180,423	\$186,339	\$192,448	\$198,755	\$204,718	Risk Adjusted Assets * Tier 1 Capital Ratio
Change in regulatory capital (Tier 1)		\$5,549	\$5,729	\$5,916	\$6,109	\$6,307	\$5,963	Change in Tier 1 capital from year to year
Book Equity	\$182,194	\$187,743	\$193,472	\$199,388	\$205,497	\$211,804	\$218,158	Book equity + (Net Income - FCFE)
ROE	8.78%	8.92%	9.07%	9.21%	9.36%	9.50%	9.50%	Improves to 9.5% (5-year average) over time
Net Income	\$14,845	\$16,254	\$17,021	\$17,820	\$18,653	\$19,522	\$20,121	Book Equity * ROE
- Investment in Regulatory Capital		\$5,549	\$5,729	\$5,916	\$6,109	\$6,307	\$6,354	Change in regulatory capital
FCFE		\$10,705	\$11,291	\$11,904	\$12,545	\$13,215	\$13,767	Net Income - Change in regulatory capital
Terminal value of equity						158,791.87 €		3% growth in perpetuity on steady state CF
Present value		9,586.43 €	9,054.51 €	8,548.36 €	8,067.12 €	99,051.91 €		PV of cash flows (and terminal equity value)
Cost of equity	11.67%	11.67%	11.67%	11.67%	11.67%	11.67%	11.67%	Implied cost of equity of 25 biggest banks
Value of equity today =	\$134,308							
Number of shares outstanding =	1958.30							
Value per share =	\$68.58							
Stock price in May 2023 =	\$46.32							
% Under or over valued =	-32.46%							

Implied cost of equity for big banks

Median price to book = 1.04
 Median ROE in 2022 = 12.00%
 Expected growth rate = 3.3% (equal to T.Bond rate)
 $PBV = (ROE - g) / (Cost\ of\ equity - g)$
 $1.04 = (.12 - .033) / (Cost\ of\ equity - .033)$
 Solving, Cost of equity = 11.67%

IV. VALUING CYCLICAL AND COMMODITY COMPANIES

Company growth often comes from movements in the economic cycle, for cyclical firms, or commodity prices, for commodity companies.

What are the cashflows from existing assets?

Historical revenue and earnings data are volatile, as the economic cycle and commodity prices change.

What is the value added by growth assets?

How risky are the cash flows from both existing assets and growth assets?

Primary risk is from the economy for cyclical firms and from commodity price movements for commodity companies. These risks can stay dormant for long periods of apparent prosperity.

When will the firm become a mature firm, and what are the potential roadblocks?

For commodity companies, the fact that there are only finite amounts of the commodity may put a limit on growth forever. For cyclical firms, there is the peril that the next recession may put an end to the firm.

LESSON 1: WITH “MACRO” COMPANIES, IT IS EASY TO GET LOST IN “MACRO” ASSUMPTIONS...

- With cyclical and commodity companies, it is undeniable that the value you arrive at will be affected by your views on the economy or the price of the commodity.
- Consequently, you will feel the urge to take a stand on these macro variables and build them into your valuation. Doing so, though, will create valuations that are jointly impacted by your views on macro variables and your views on the company, and it is difficult to separate the two.
- The best (though not easiest) thing to do is to separate your macro views from your micro views. Use current market based numbers for your valuation, but then provide a separate assessment of what you think about those market numbers.

SHELL'S REVENUES & OIL PRICES

Shell: Revenues vs Oil Price

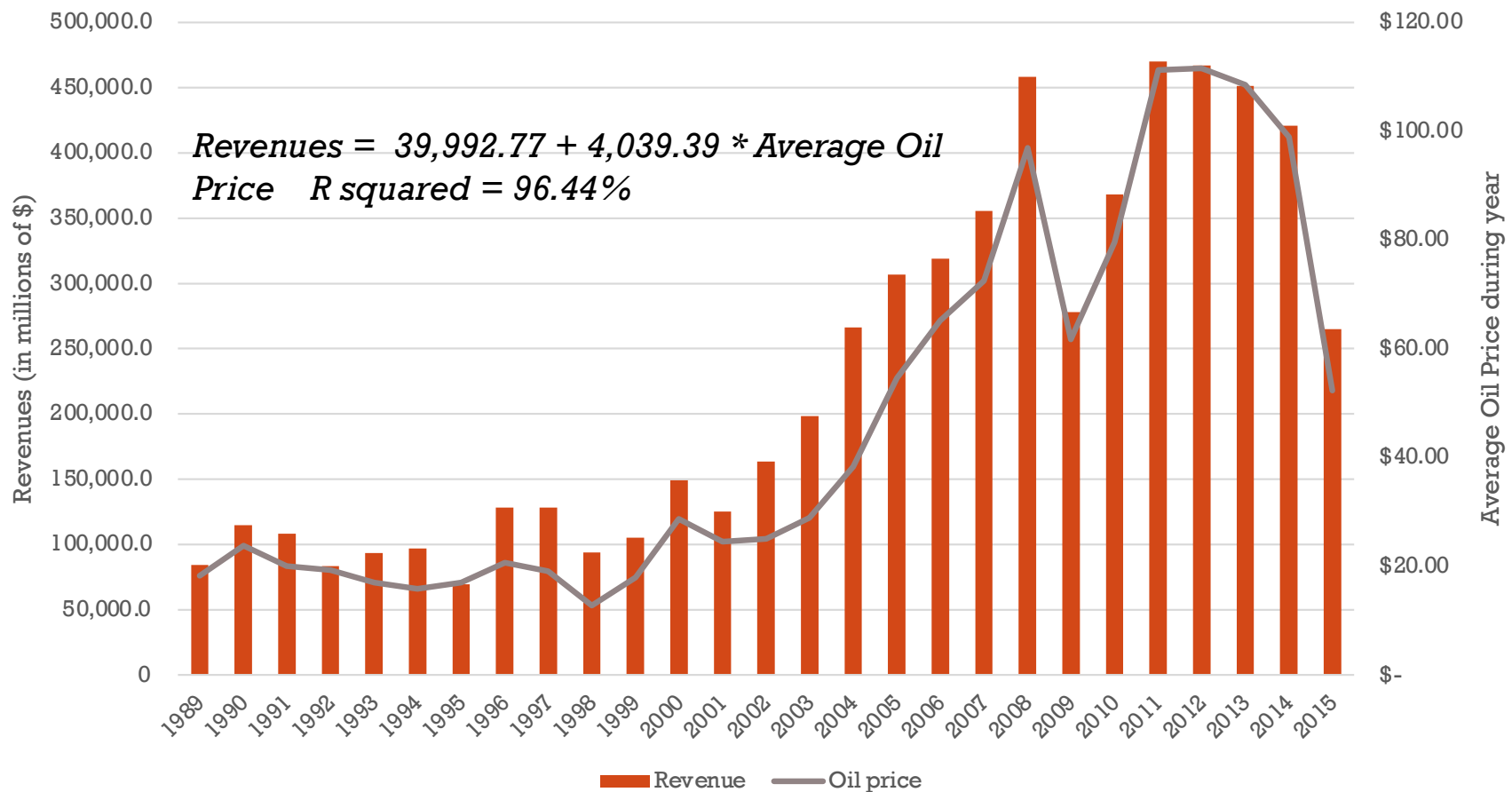

Shell: A "Oil Price" Neutral Valuation: March 2016

Revenue calculated from prevailing oil price of \$40/barrel in March 2016
 Revenue = 39992.77+4039.40*\$40
 = \$201,569

Compounded revenue growth of 3.91% a year, based on Shell's historical revenue growth rate from 2000 to 2015

	Base Year	1	2	3	4	5	Terminal Year
Revenues	\$ 201,569	\$ 209,450	\$ 217,639	\$ 226,149	\$ 234,991	\$ 244,180	\$ 249,063
Operating Margin	3.01%	6.18%	7.76%	8.56%	8.95%	9.35%	9.35%
Operating Income	\$ 6,065.00	\$ 12,942.85	\$ 16,899.10	\$ 19,352.39	\$ 21,040.39	\$ 22,830.80	\$ 23,287.41
Effective tax rate	30.00%	30.00%	30.00%	30.00%	30.00%	30.00%	30.00%
AT Operating Income	\$ 4,245.50	\$ 9,060.00	\$ 11,829.37	\$ 13,546.68	\$ 14,728.27	\$ 15,981.56	\$ 16,301.19
+ Depreciation	\$ 26,714.00	\$ 27,759	\$ 28,844	\$ 29,972	\$ 31,144	\$ 32,361	
- Cap Ex	\$ 31,854.00	\$ 33,099	\$ 34,394	\$ 35,738	\$ 37,136	\$ 38,588	
- Chg in WC		\$ 472.88	\$ 491.37	\$ 510.58	\$ 530.55	\$ 551.29	
FCFF		\$ 3,246.14	\$ 5,788.19	\$ 7,269.29	\$ 8,205.44	\$ 9,203.68	\$ 13,011.34
Terminal Value						\$ 216,855.71	
Return on capital							12.37%
Cost of Capital		9.91%	9.91%	9.91%	9.91%	9.91%	8.00%
Cumulated Discount Factor		1.0991	1.2080	1.3277	1.4593	1.6039	
Present Value		\$ 2,953.45	\$ 4,791.47	\$ 5,474.95	\$ 5,622.81	\$ 140,940.73	
Value of Operating Assets	\$ 159,783.41						
+ Cash	\$ 31,752.00						
+ Cross Holdings	\$ 33,566.00						
- Debt	\$ 58,379.00						
- Minority Interests	\$ 1,245.00						
Value of Equity	\$ 165,477.41						
Number of shares	4209.7						
Value per share	\$ 39.31						

Operating margin converges on Shell's historical average margin of 9.35% from 200-2015

Return on capital reverts and stays at Shell's historic average of 12.37% from 200-2015

Added long term investments in joint ventures and subtracted out minority interest in consolidated holdings.

LESSON 2: USE PROBABILISTIC TOOLS TO ASSESS VALUE AS A FUNCTION OF MACRO VARIABLES...

- If there is a key macro variable affecting the value of your company that you are uncertain about (and who is not), why not quantify the uncertainty in a distribution (rather than a single price) and use that distribution in your valuation.
- That is exactly what you do in a Monte Carlo simulation, where you allow one or more variables to be distributions and compute a distribution of values for the company.
- With a simulation, you get not only everything you would get in a standard valuation (an estimated value for your company) but you will get additional output (on the variation in that value and the likelihood that your firm is under or over valued)

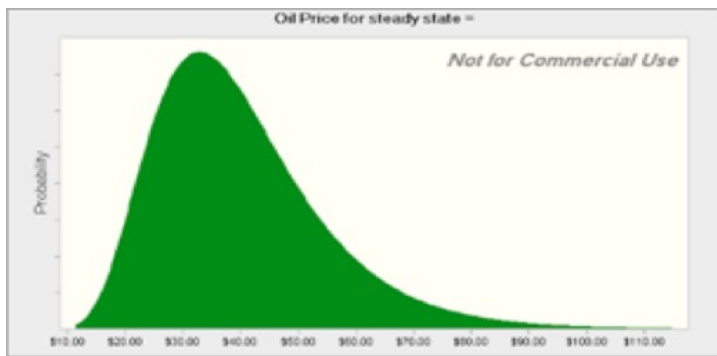

Revenue calculated from the oil price drawn from distribution
 $Revenue = 39992.77 + 4039.40 * \text{Oil Price/Barrel}$

Pre-tax Operating Income based on revenue & selected margin
 $Pre\text{-tax Operating Income} = Revenues * Operating\ Margin$



Value Shell based on operating income, assuming other assumptions (tax rate, revenue growth, cost of capital)

Percentiles:	Forecast values
0%	\$6.55
10%	\$23.90
20%	\$27.73
30%	\$30.89
40%	\$33.88
50%	\$36.99
60%	\$40.28
70%	\$44.22
80%	\$49.24
90%	\$57.49
100%	\$197.11

Aswath Damodaran

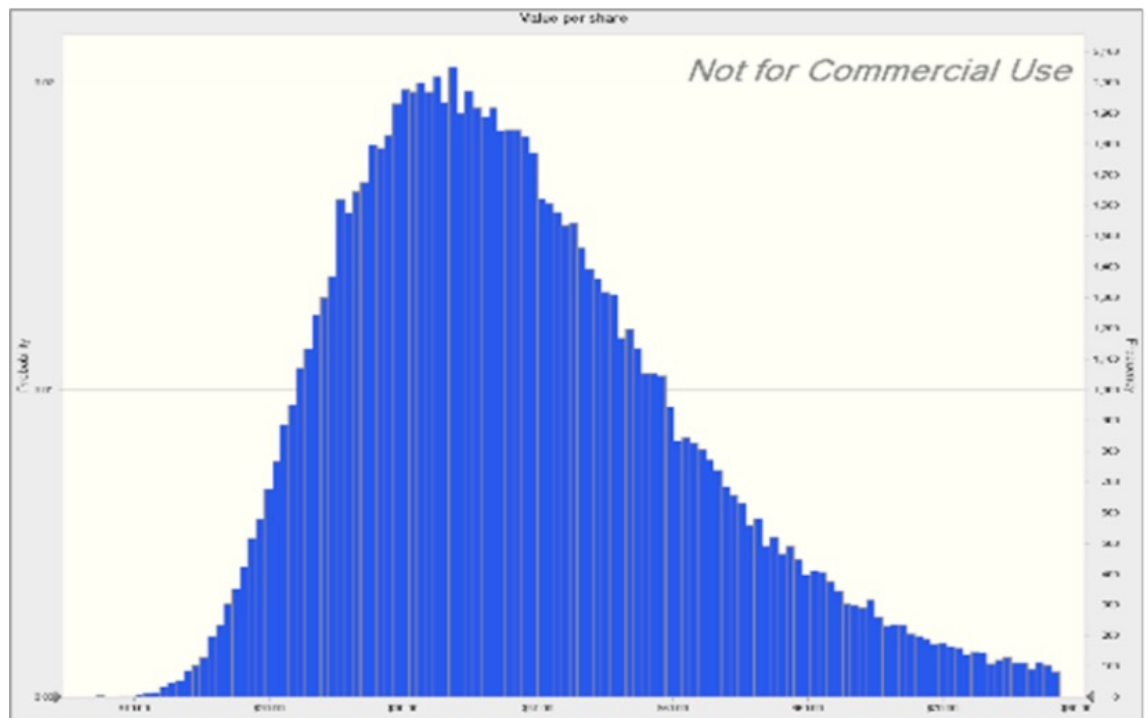

VALUING ARAMCO: POTENTIAL DIVIDENDS

A Potential Dividend (FCFE) Discount Model Valuation of Aramco

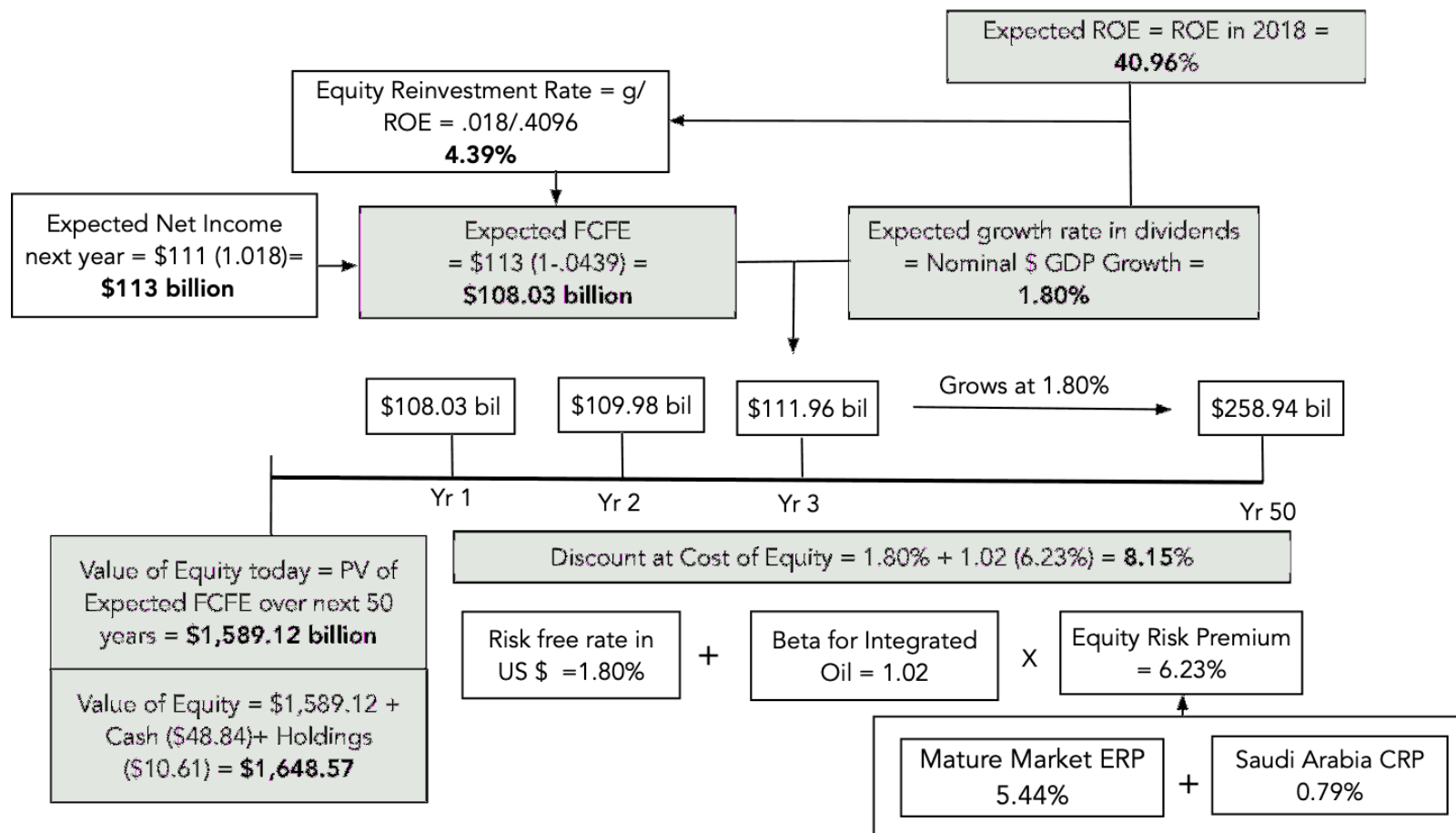

ADJUSTING FOR REGIME CHANGE

- If you believe that there is no chance of regime change, your expected value will remain \$1.65 trillion.
 - If you believe that regime change is imminent, and that your equity will be fully expropriated, your expected value will be zero.
 - If you believe that there remains a non-trivial chance (perhaps as high as 20%) that there will be a regime change and that if there is one, there will be changes that reduce, but not
- exti

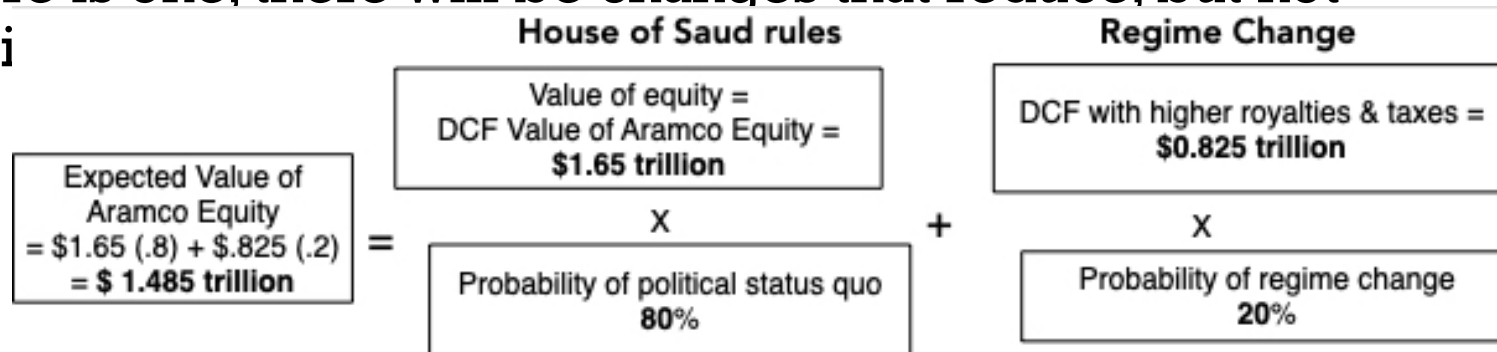

THE OPTIONALITY IN COMMODITIES: UNDEVELOPED RESERVES AS AN OPTION

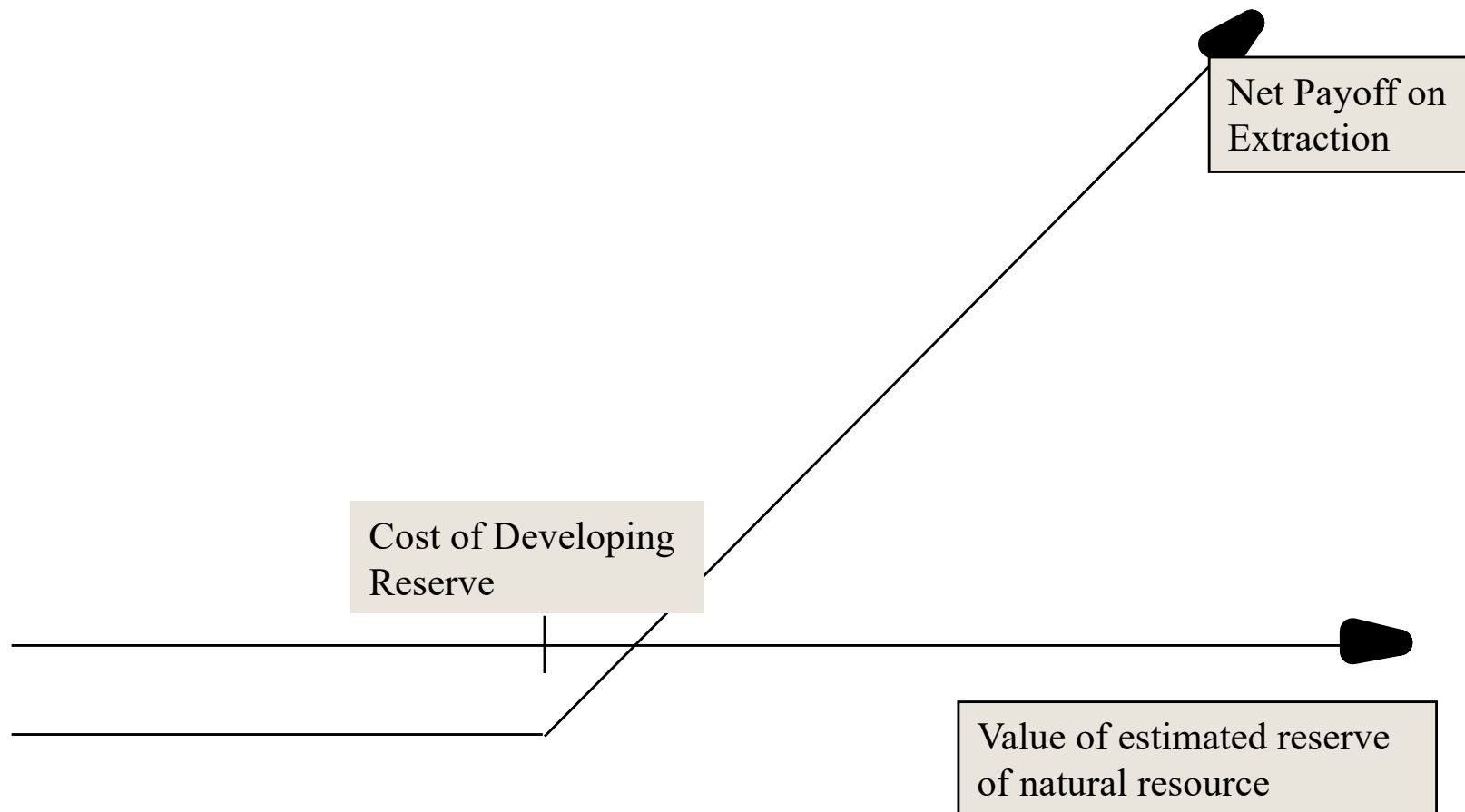

IMPLICATIONS

- **Optionality Premium:** Undeveloped reserves have option value that will give them a premium over their DCF value. Put simply, even non-viable reserves have value, because commodity prices can bounce back.
 - The option premium will be greater when commodity prices are low, rather than when oil prices are high.
 - The option premium will increase if commodity prices are expected to become more volatile.
- **Level + Variance:** The value of a commodity company is affected by both the level of oil prices, as well as the volatility in that level. The former affects your DCF and the latter the optionality.

V. VALUING INFRASTRUCTURE COMPANIES AND PROJECTS

Regulatory and legal constraints: Infrastructure investments often have a regulatory overlay, defining not just ownership rights, but also pricing power (in what can be charged to the customers/tenants/users of the infrastructure).

1. How long will construction take?
2. Are construction expenses contractually set?
3. How is construction funded?

1. What form will operating revenues take?
2. What time pattern will cash flows take?
3. What expenses will there be for ongoing operation & maintenance?

1. Does the investment have a finite life?
2. If yes, what will the assets be worth at the end of the life?
3. If not, what happens to cashflows after end of forecast period?

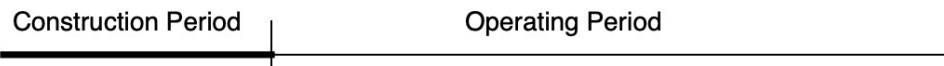

The upfront negative cash flows and the heavy use of debt can expose the firm/project to failure risk.

Discount rates used should reflect uncertainty about cash flows, and thus may be different for investment & operating cash flows.

Debt often utilized in early years, and paid down over the project life leading to changing debt ratios and levered betas.

Subsidies and Options: To the extent that there are public interests at play, governments may provide subsidies, either directly or in below-cost financing, and there will also be special provisions in the case of default and bankruptcy.

ESTIMATING CASH FLOWS

- The cash flows will reflect the reality of infrastructure investments, with
 - An **early stretch of negative cash flows**, as the investment gets built.
 - Positive cash flows, starting when the infrastructure investment has been built, with the **level of the cash flows determined by how much pricing power the infrastructure project has been given**.
 - Since much of the investment is up front, **depreciation is likely to be a cash flow add on** (with little or no cap ex netted out) during the operating cash flow period.
 - To the extent that regulatory changes can affect the expected revenues and cash flows, they should be built in either through expected cash flows or simulations.
- At the end of the forecast period, the terminal value can be a liquidation value, if the investment is finite, or a going concern value, if it will continue.

ESTIMATING DISCOUNT RATES

- In the years of infrastructure building, with negative cash flows, **your cost of capital will converge on the cost of debt**, since many of the expenses are contractually set.
- In the face of a shifting capital structure, there are two choices that you face, when valuing infrastructure investments:
 - **Year-specific costs of capital:** In the first approach, the cost of capital is computed each year, with the estimated debt ratio and costs of debt and equity in that year, with the tax advantage being applied to debt, only if the project's earnings are taxable.
 - **Average cost of capital across life:** In the second approach, the cost of capital is computed using an average debt ratio and cost of debt over the project life, with a beta reflecting that average debt ratio.

V. VALUING COMPANIES ACROSS THE OWNERSHIP CYCLE

Reported income and balance sheet are heavily affected by tax considerations rather than information disclosure requirements. The line between the personal and business expenses is a fine one.

What are the **cashflows from existing assets**?

- Equity: Cashflows after debt payments
- Firm: Cashflows before debt payments

Reversing investment mistakes is difficult to do. The need for and the cost of illiquidity has to be incorporated into current

What is the **value added** by growth assets?
Equity: Growth in equity earnings/ cashflows
Firm: Growth in operating earnings/ cashflows

How **risky** are the **cash flows** from both existing assets and growth assets?
Equity: Risk in equity in the company
Firm: Risk in the firm's operations

Different buyers can perceive risk differently in the same private business, largely because what they see as risk will be a function of how diversified they are. The fall back positions of using market prices to extract risk measures does not

When will the firm become a **mature firm**, and what are the potential roadblocks?

Many private businesses are finite life enterprises, not expected to last into perpetuity

Kristin's Kandy: Valuation in March 2006

Current Cashflow to Firm
 EBIT(1-t) : 300
 - Nt CpX 100
 - Chg WC 40
 = FCFF 160
 Reinvestment Rate = 46.67%

Reinvestment Rate
 46.67%

Expected Growth in EBIT (1-t)
 $.4667 \times .1364 = .0636$
6.36%

Return on Capital
 13.64%

Stable Growth
 $g = 4\%$; $\text{Beta} = 3.00$;
 $\text{ROC} = 12.54\%$
 Reinvestment Rate = 31.90%

Terminal Value₅ = $289 / (.1254 - .04) = 3,403$

Year	1	2	3	4	5
EBIT (1-t)	\$319	\$339	\$361	\$384	\$408
- Reinvestment	\$149	\$158	\$168	\$179	\$191
=FCFF	\$170	\$181	\$193	\$205	\$218

Term Yr
 425
 136
 289

Firm Value: 2,571
 + Cash 125
 - Debt: 900
 =Equity 1,796
 - Illiq Discount 12.5%
 Adj Value 1,571

Discount at Cost of Capital (WACC) = $16.26\% (.70) + 3.30\% (.30) = 12.37\%$

Cost of Equity
 16.26%

Cost of Debt
 $(4.5\% + 1.00)(1 - .40)$
 = 3.30%
 Synthetic rating = A-

Weights
 E = 70% D = 30%

Riskfree Rate:
 Riskfree rate = 4.50%
 (10-year T.Bond rate)

Total Beta
 2.94

Risk Premium
 4.00%

1/3 of risk is market risk

Adjusted for ownrer non-diversification

Market Beta: 0.98

Mature risk premium
 4%

Country Risk Premium
 0%

Aswath Damodaran

Unlevered Beta for Sectors: 0.78

Firm's D/E Ratio: 30/70

Private Owner versus Publicly Traded Company Perceptions of Risk in an Investment

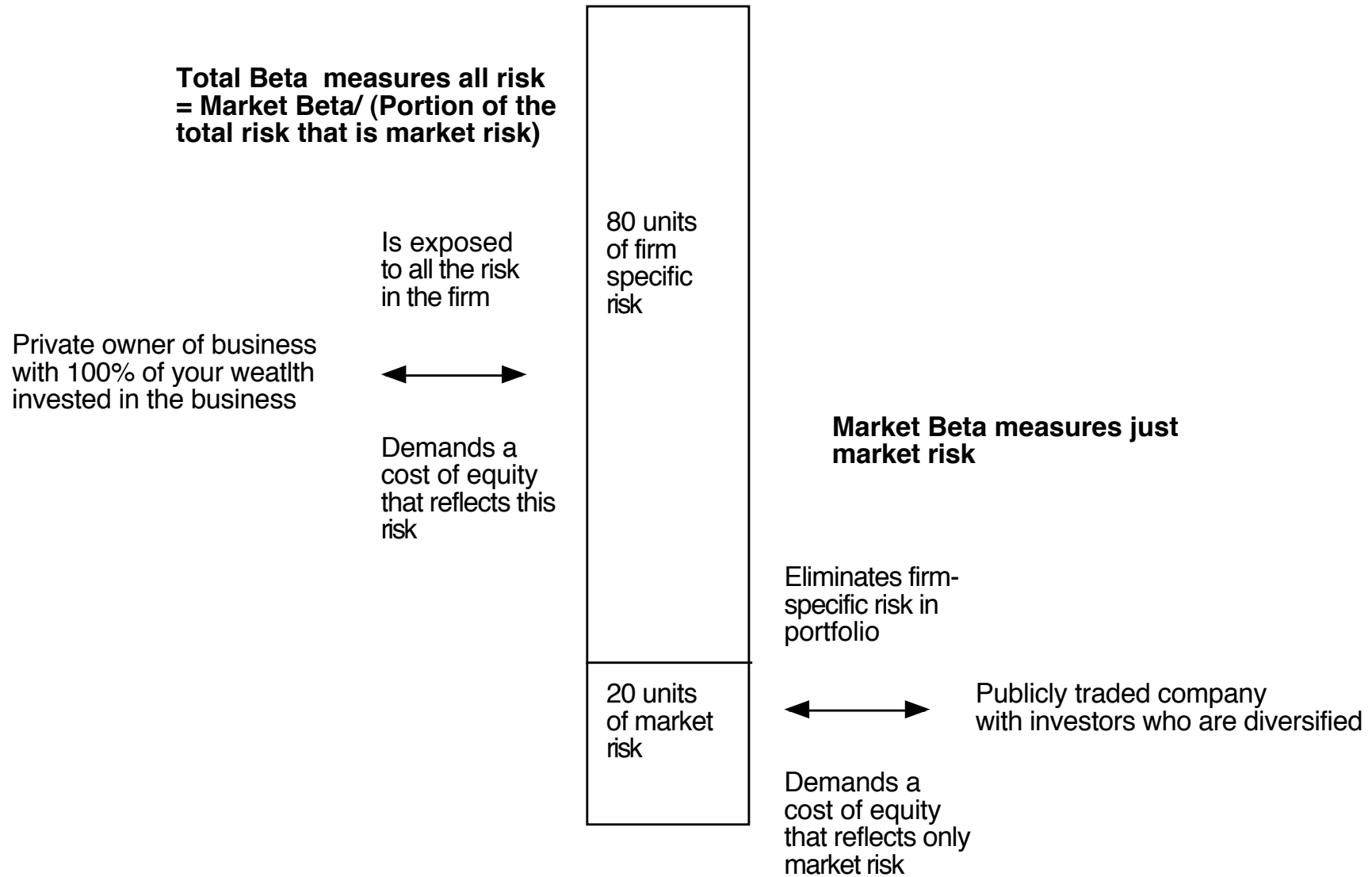

TOTAL RISK VERSUS MARKET RISK

- Adjust the beta to reflect total risk rather than market risk. This adjustment is a relatively simple one, since the R squared of the regression measures the proportion of the risk that is market risk.
 - Total Beta = Market Beta / Correlation of the sector with the market
- To estimate the beta for Kristin Kandy, we begin with the bottom-up unlevered beta of food processing companies:
 - Unlevered beta for publicly traded food processing companies = 0.78
 - Average correlation of food processing companies with market = 0.333
 - Unlevered total beta for Kristin Kandy = $0.78/0.333 = 2.34$
 - Debt to equity ratio for Kristin Kandy = $0.3/0.7$ (assumed industry average)
 - Total Beta = $2.34 (1 - (1-.40)(30/70)) = 2.94$
 - Total Cost of Equity = $4.50\% + 2.94 (4\%) = 16.26\%$

LESSON 2: WITH FINANCIALS, TRUST BUT VERIFY..

- **Different Accounting Standards:** The accounting statements for private firms are often based upon different accounting standards than public firms, which operate under much tighter constraints on what to report and when to report.
- **Intermingling of personal and business expenses:** In the case of private firms, some personal expenses may be reported as business expenses.
- **Separating “Salaries” from “Dividends”:** It is difficult to tell where salaries end and dividends begin in a private firm, since they both end up with the owner.
- **The Key person issue:** In some private businesses, with a personal component, the cashflows may be intertwined with the owner being part of the business.

KEY PERSON: PATHWAYS TO VALUE

Key Person Value Effect

Key Management Person (CEO or Founder): Sets or alters narrative for the business, and in the process, changes expectations of revenue growth, margins, reinvestment and risk, in good (value-increasing) or bad (value-decreasing) ways.

Key Sales Person: Through client relationships and new customers/clients, driving sales (and sales growth).

Key (outside) Spokesperson: As the face of a company's products, can add or detract from its sales and pricing power (margins)

Key Design/Research Person: Involved in creation of design of product/service, driving both sales and margins.

Key Production Person: Instrumental in design/production of product or service and delivery (supply chains), affecting margins and investment efficiency.

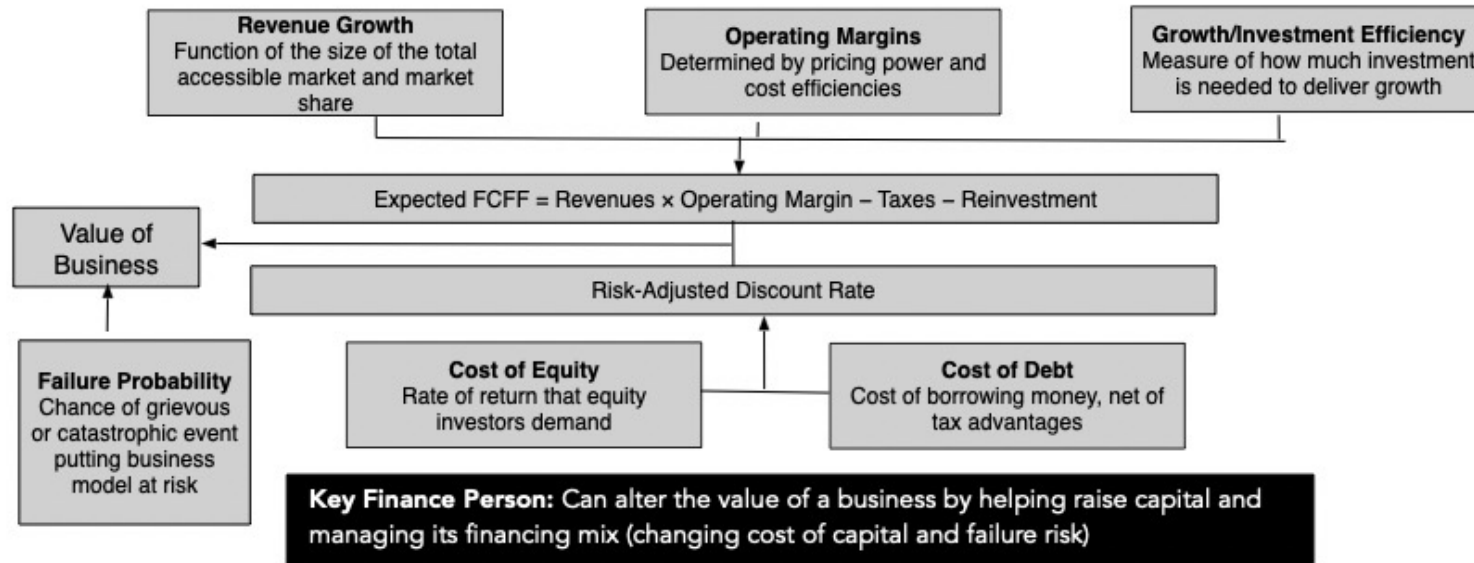

LESSON 3: ILLIQUIDITY IS A CLEAR AND PRESENT DANGER.

- In private company valuation, illiquidity is a constant theme. All the talk, though, seems to lead to a rule of thumb. The illiquidity discount for a private firm is between 20-30% and does not vary across private firms.
- But illiquidity should vary across:
 - Companies: Healthier and larger companies, with more liquid assets, should have smaller discounts than money-losing smaller businesses with more illiquid assets.
 - Time: Liquidity is worth more when the economy is doing badly and credit is tough to come by than when markets are booming.
 - Buyers: Liquidity is worth more to buyers who have shorter time horizons and greater cash needs than for longer term investors who don't need the cash and are willing to hold the investment.

ESTIMATING AN ILLIQUIDITY DISCOUNT

- **The Bludgeon Approach:** Many practitioners use a fixed illiquidity discount, often around 25%, to reduce the values of all private business, no matter who the buyer, what the firm looks like or market conditions.
- **The Refined Bludgeon Approach:** Start with a fixed discount, but alter it (subjectively or numerically) to reflect business, buyer and market conditions.
- **Illiquidity as an option:** In a sense, liquidity provides the option to an asset's holder to sell at the prevailing market price, and not having it therefore can be viewed as the loss of this put option.
- **The Bid Ask Spread Variant:** All investments, including the most liquid publicly traded stock, are illiquid, with the bid ask spread (as percent of the price) representing the magnitude of the illiquidity.

AND IT IS NOT JUST IN PRIVATE BUSINESSES..

- Assume that you are valuing a closely held company in a lightly traded market. Will the possibility of illiquidity affect your valuation of the company?
 - a. Yes
 - b. No
- If it will affect your valuation, how will it show up?
- If it will not affect your valuation, how would it show up in your investment process?

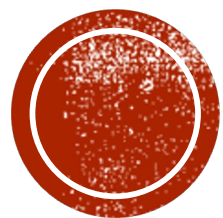

INTRINSIC VALUE: STORY + NUMBERS

Work on your weak side...

VALUATION AS A BRIDGE

Number Crunchers

What stories do for a numbers valuation

1. Stories are better "hooks" & more memorable.
2. Stories force consistency tests on numbers.
3. Stories allow for follow through in businesses.

Valuation Numbers

The Dangers of a pure numbers valuation

1. You can "play" with numbers to change value
2. You can fool yourself with false precision
3. You can deny your own biases

Story Tellers

What numbers can do for a story valuation

1. Numbers give stories credibility.
2. Numbers allow for plausibility checks
3. Numbers create accountability in businesses.

Valuation Story

The Dangers of a pure story valuation

1. You can tell fairy tales
2. You will be guided by anecdotal evidence
3. Your biases will be unconstrained

**A Good Valuation =
Story + Numbers**

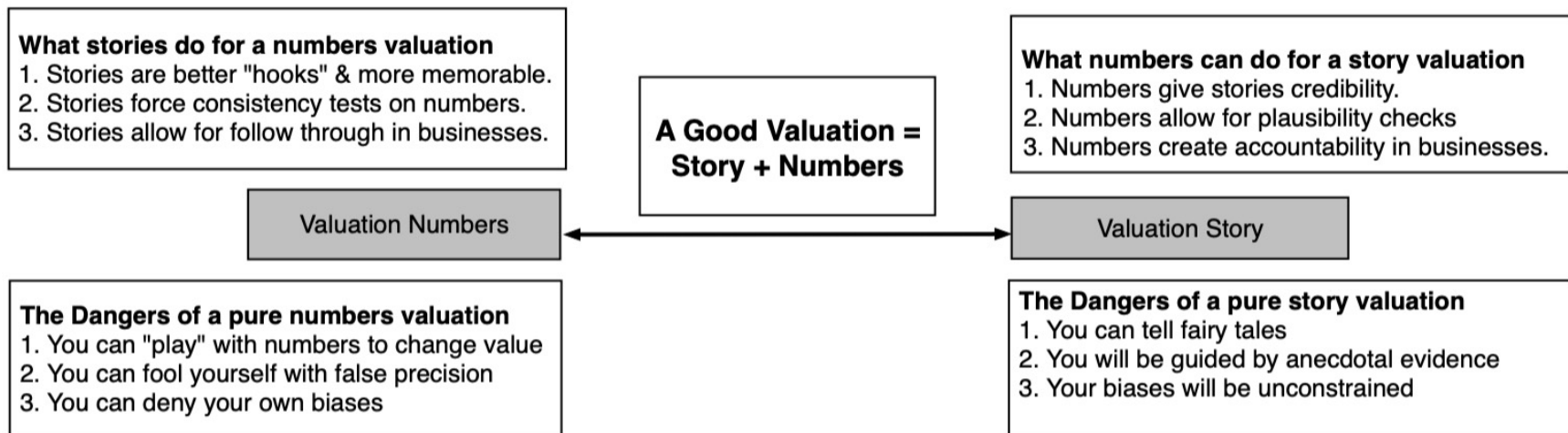

FROM STORY TO NUMBERS AND BEYOND..

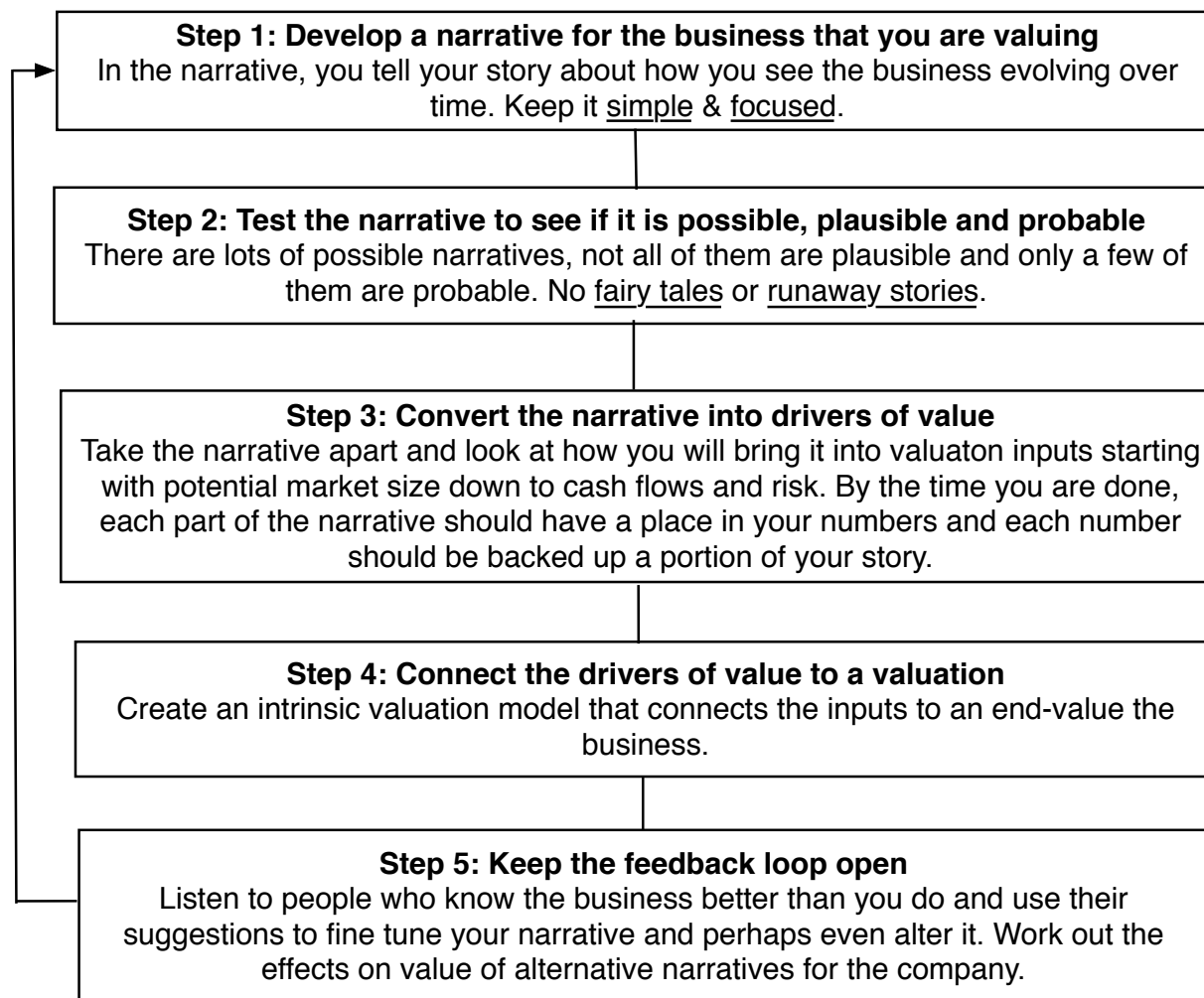

STEP 1A: SURVEY THE LANDSCAPE

- Every valuation starts with a narrative, a story that you see unfolding for your company in the future.
- In developing this narrative, you will be making assessments of
 - Your **company** (its products, its management and its history).
 - The **market or markets** that you see it growing in.
 - The **competition** it faces and will face.
 - The **macro environment** in which it operates.
- If understanding the products and services that a business sells makes it easier to construct a story, it follows that B2C (sell to final consumer) businesses will be easier to value than B2B businesses.

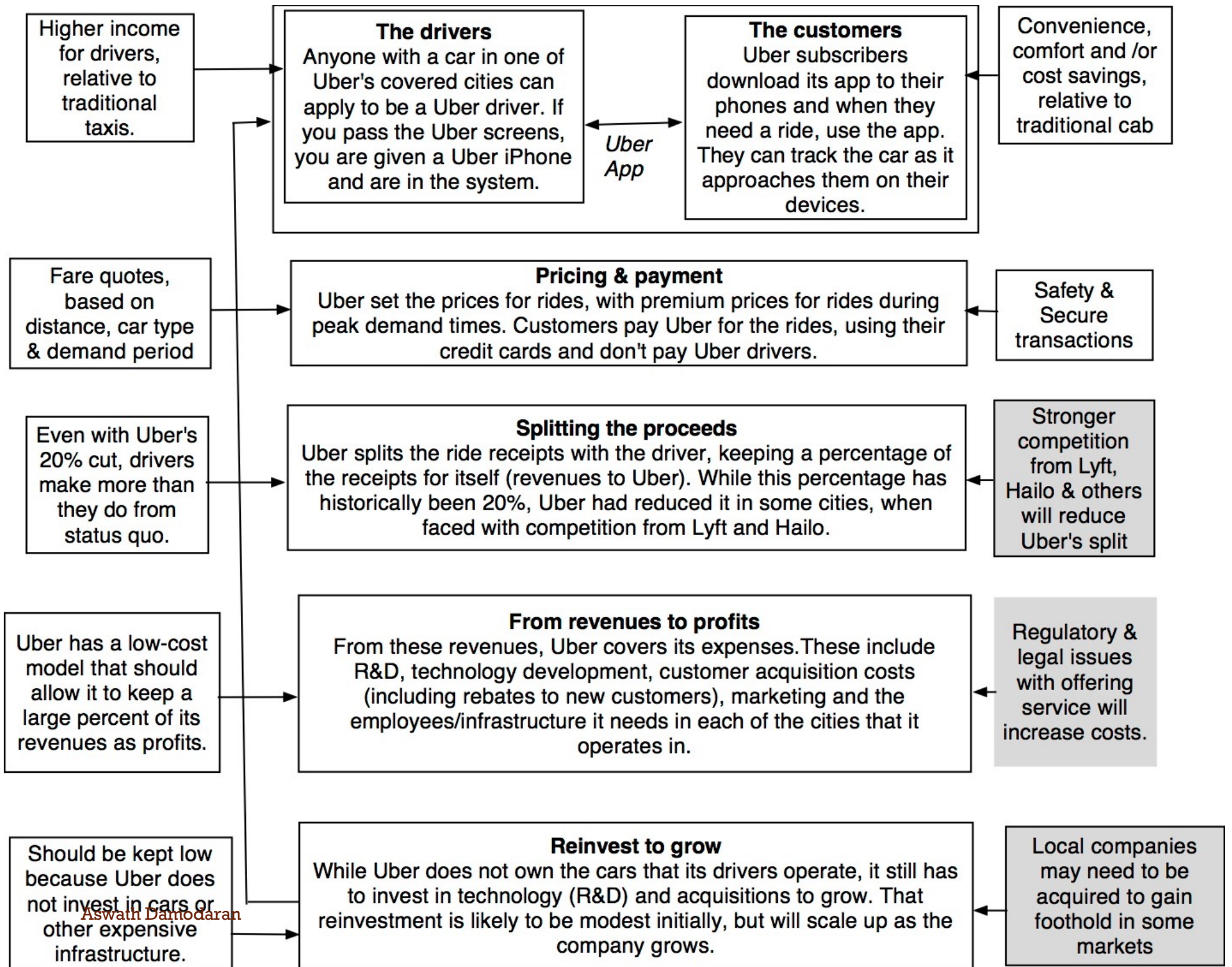

Low Growth

The Auto Business

Low Margins

Year	Revenues (\$)	% Growth Rate
2005	1,274,716.60	
2006	1,421,804.20	11.54%
2007	1,854,576.40	30.44%
2008	1,818,533.00	-1.94%
2009	1,572,890.10	-13.51%
2010	1,816,269.40	15.47%
2011	1,962,630.40	8.06%
2012	2,110,572.20	7.54%
2013	2,158,603.00	2.28%
2014	2,086,124.80	-3.36%
Rounded Average =		5.63%

+

The Automobile Business: Pre-tax Operating Margins in 2015

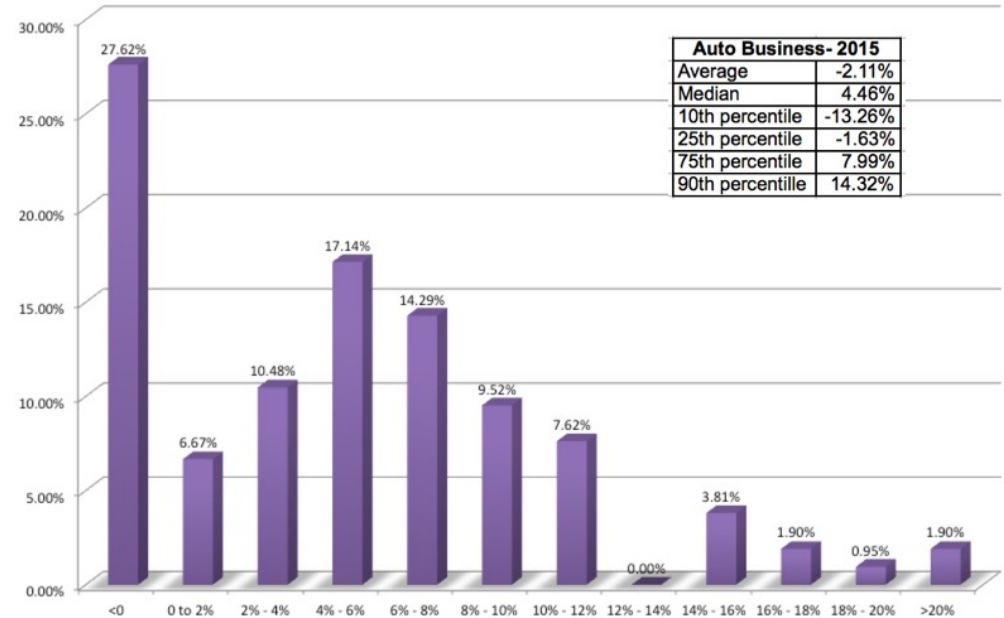

Auto Business-2015	
Average	-2.11%
Median	4.46%
10th percentile	-13.26%
25th percentile	-1.63%
75th percentile	7.99%
90th percentile	14.32%

High & Increasing Reinvestment

The Reinvestment Burden: Investment as % of Sales for Auto Business

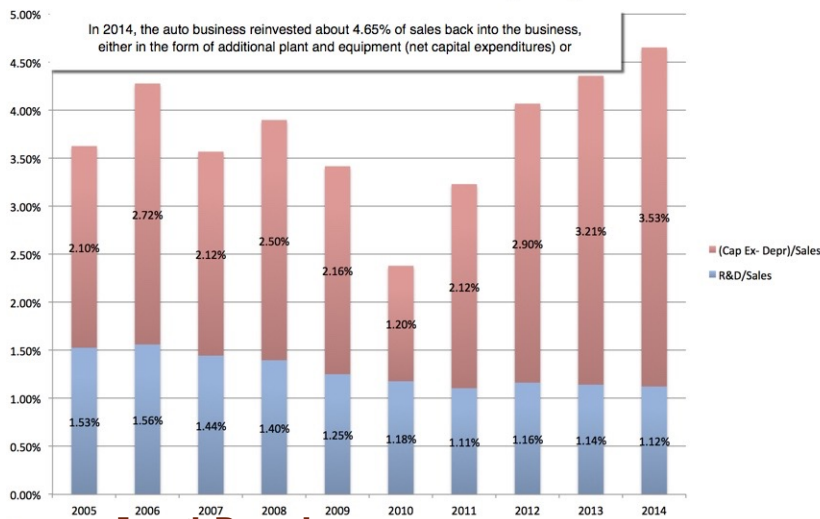

Aswath Damodaran

=

Bad Business

	ROIC	Cost of capital	ROIC - Cost of capital
2004	6.82%	7.93%	-1.11%
2005	10.47%	7.02%	3.45%
2006	4.60%	7.97%	-3.37%
2007	7.62%	8.50%	-0.88%
2008	3.48%	8.03%	-4.55%
2009	-4.97%	8.58%	-13.55%
2010	5.16%	8.03%	-2.87%
2011	7.55%	8.15%	-0.60%
2012	7.80%	8.55%	-0.75%
2013	7.83%	8.47%	-0.64%
2014	6.47%	7.53%	-1.06%

Only once in the last 10 years have auto companies collectively earned more than their cost of capital

WHAT MAKES FERRARI DIFFERENT?

Ferrari: Geographical Sales (2014)

Ferrari sold only 7,255 cars in all of 2014

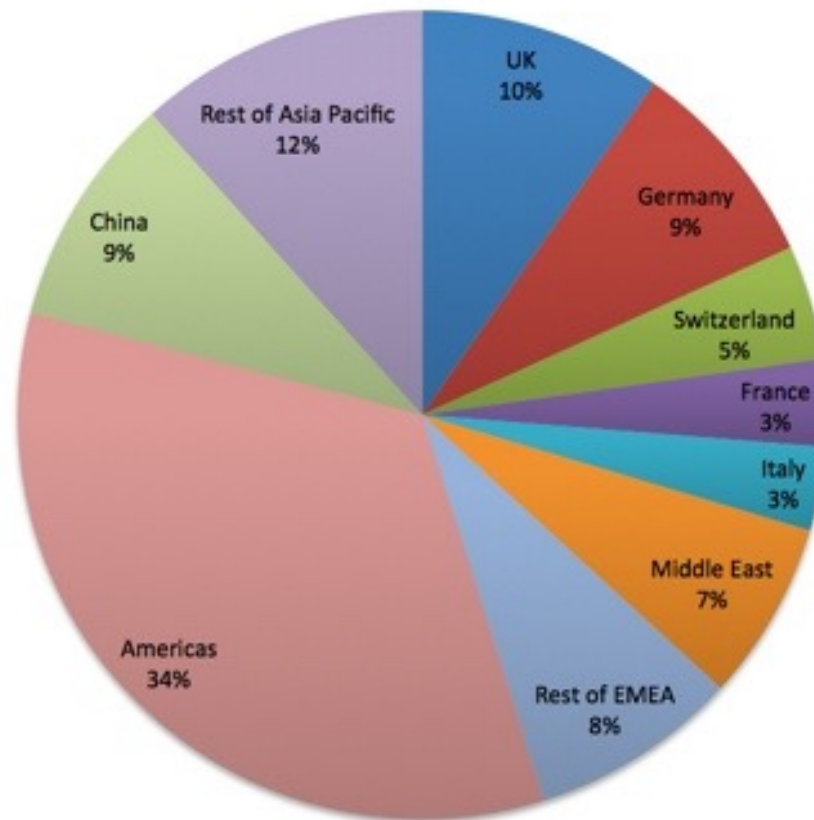

Ferrari sales (in units) have grown very little in the last decade & have been stable

Ferrari had a profit margin of 18.2%, in the 95th percentile, partly because of its high prices and partly because it spends little on advertising.

Ferrari has not invested in new plants.

STEP 1B: CREATE A NARRATIVE FOR THE FUTURE

- Every valuation starts with a narrative, a story that you see unfolding for your company in the future.
- That story should capture the essence of what the company does well, what it does badly and how you see it evolving over time.
- In developing this narrative, you will be making assessments of your company (its products, its management), the market or markets that you see it growing in, the competition it faces and will face and the macro environment in which it operates.
 - Rule 1: Keep it simple.
 - Rule 2: Keep it focused.

THE UBER NARRATIVE

- In June 2014, my initial narrative for Uber was that it would be
 1. **An urban car service business:** I saw Uber primarily as a force in urban areas and only in the car service business.
 2. Which would **expand the business moderately** (about 40% over ten years) by bringing in new users.
 3. **With local networking benefits:** If Uber becomes large enough in any city, it will quickly become larger, but that will be of little help when it enters a new city.
 4. **Maintain its revenue sharing (20%) system** due to strong competitive advantages (from being a first mover).
 5. And its **existing low-capital business model**, with drivers as contractors and very little investment in infrastructure.

THE FERRARI NARRATIVE

- Ferrari will stay an exclusive auto club, deriving its allure from its scarcity and the fact that only a few own Ferraris.
- By staying exclusive, the company gets three benefits:
 - It can **continue to charge nose bleed prices** for its cars and sell them with little or no advertising.
 - It **does not need to invest in new assembly plants**, since it does not plan to ramp up production.
 - It **sells only to the super rich**, who are unaffected by overall economic conditions or market crises.

STEP 2: CHECK THE NARRATIVE AGAINST HISTORY, ECONOMIC FIRST PRINCIPLES & COMMON SENSE

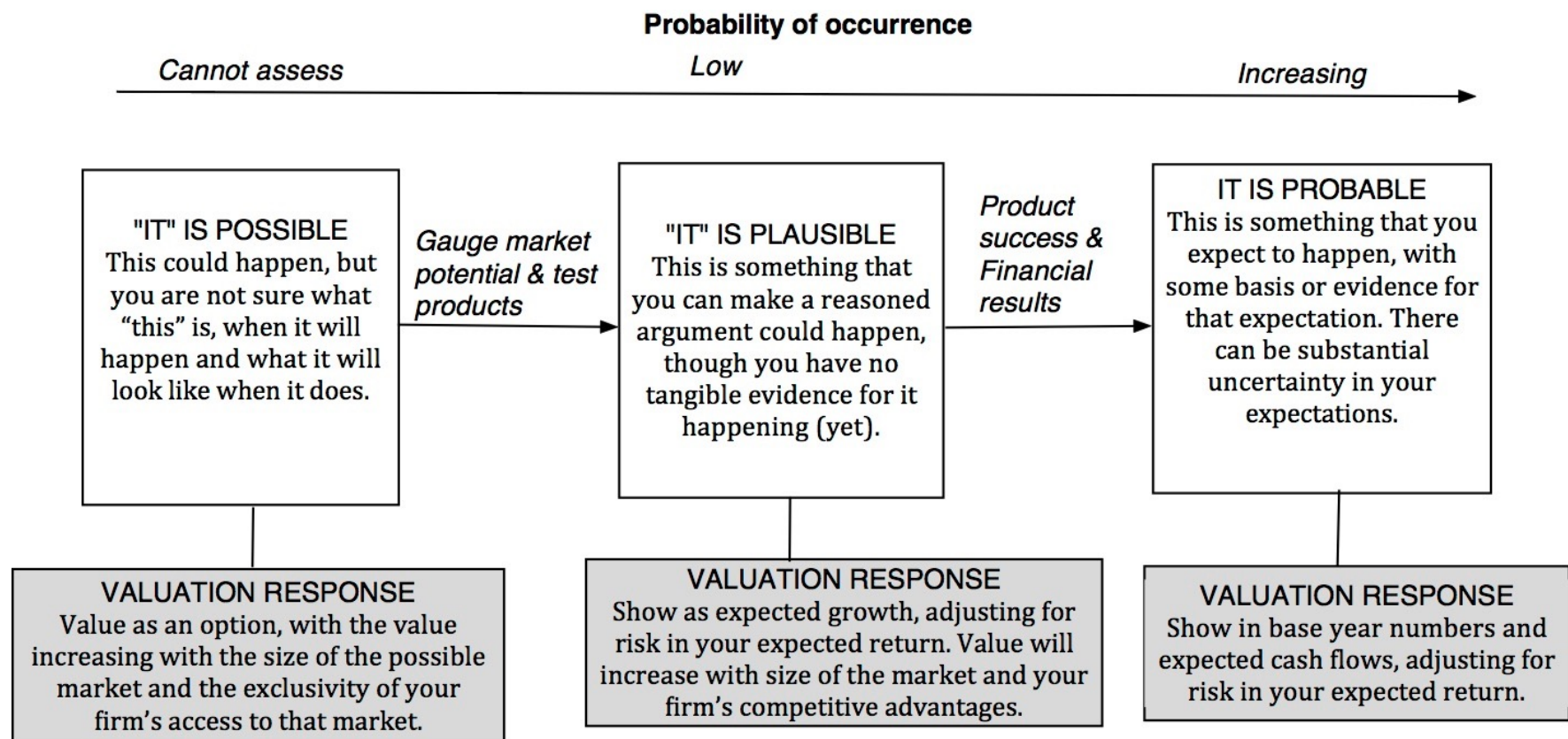

THE IMPOSSIBLE, THE IMPLAUSIBLE AND THE IMPROBABLE

The Impossible

Bigger than the economy

Assuming Growth rate for company in perpetuity > Growth rate for economy

Bigger than the total market

Allowing a company's revenues to grow so much that it has more than a 100% market share of whatever business it is in.

Profit margin > 100%

Assuming earnings growth will exceed revenue growth for a long enough period, and pushing margins above 100%

Depreciation without cap ex

Assuming that depreciation will exceed cap ex in perpetuity.

The Implausible

Growth without reinvestment

Assuming growth forever without reinvestment.

Profits without competition

Assuming that your company will grow and earn higher profits, with no competition.

Returns without risk

Assuming that you can generate high returns in a business with no risk.

The Improbable

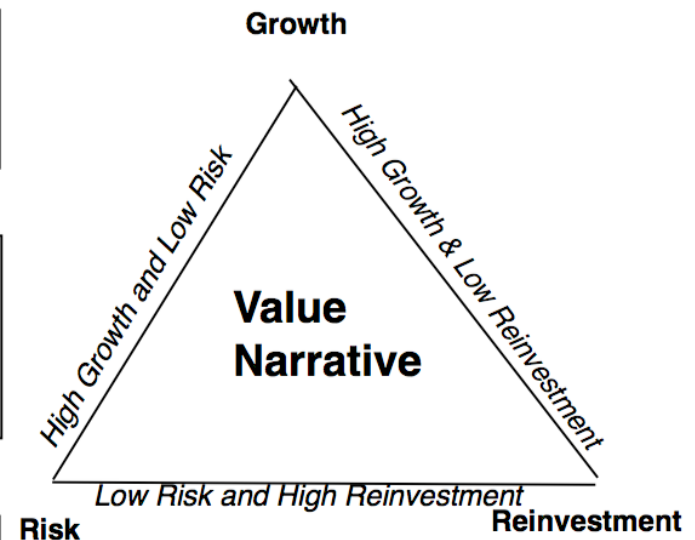

UBER: POSSIBLE, PLAUSIBLE AND PROBABLE

Uber (My narrative))

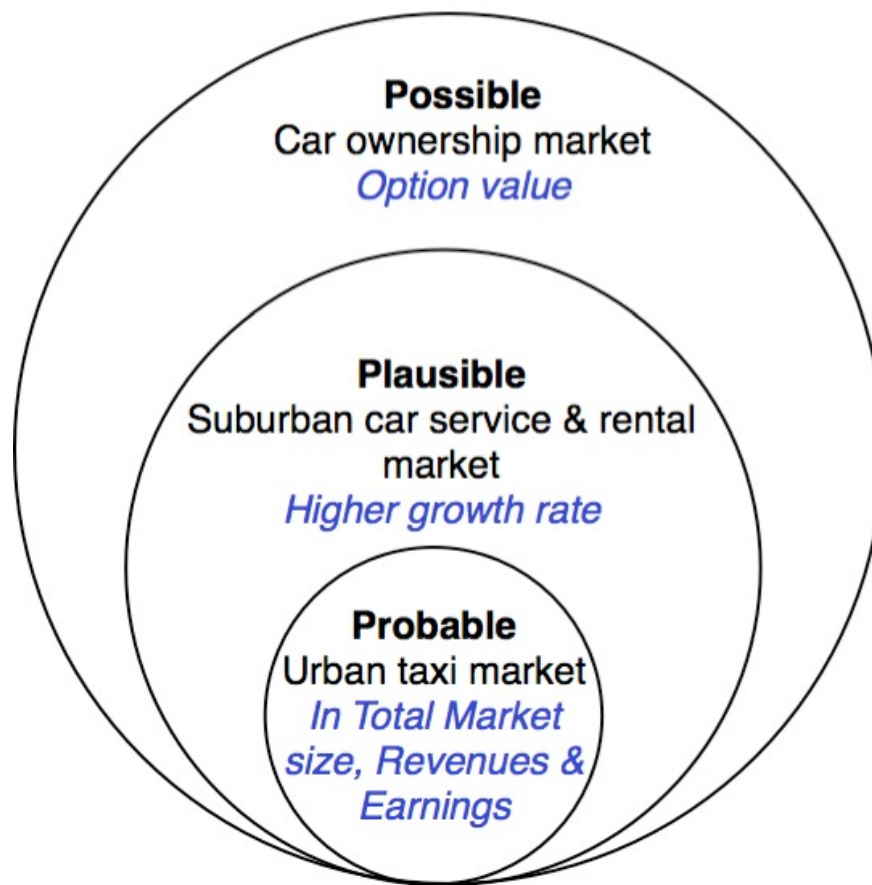

THE RUNAWAY STORY: WHEN YOU WANT A STORY TO BE TRUE...

- With a runaway business story, you usually have three ingredients:
 - **Charismatic, likeable Narrator:** The narrator of the business story is someone that you want to see succeed, either because you like the narrator or because he/she will be a good role model.
 - **Telling a story about disrupting a much business,** where you dislike the status quo: The status quo in the business that the story is disrupting is dissatisfying (to everyone involved).
 - With a **societal benefit as bonus:** And if the story holds, society and humanity will benefit.
- Since you want this story to work out, you stop asking questions, because the answers may put the story at risk.

The Impossible: The Runaway Story

The Story



+

The Checks (?)

Board Member	Designation	Age
Henry Kissinger	Former Secretary of State	92
Bill Perry	Former Secretary of Defense	88
George Schultz	Former Secretary of State	94
Bill Frist	Former Senate Majority Leader	63
Sam Nunn	Former Senator	77
Gary Roughead	Former Navy Admiral	64
James Mattis	Former Marine Corps General	65
Dick Kovocovich	Former CEO of Wells Fargo	72
Riley Bechtel	Former CEO of Bechtel	63
William Foege	Epidemiologist	79
Elizabeth Holmes	Founder & CEO, Theranos	31
Sunny Balwani	President & COO, Theranos	NA

+

Money

Companies valued at \$1 billion or more by venture-capital firms

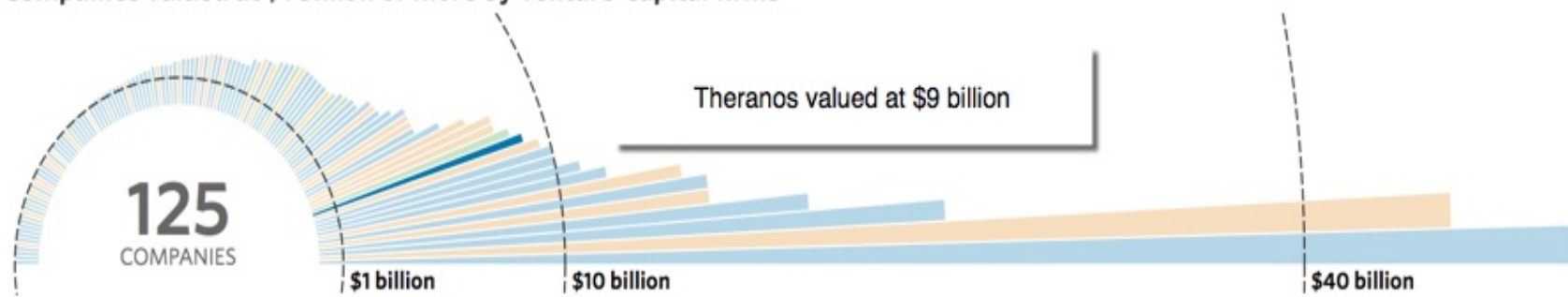

Valuations as of **October 2015**

Select companies from the chart or table for more detail.

The Improbable: Willy Wonkitis

Tesla: Summary 15-year DCF Analysis (DCF valuation as of mid-year 2013)

	FY 2013	FY 2014	FY 2015	FY 2016	FY 2017	FY 2018	FY 2019	FY 2020	FY 2021	FY 2022	FY 2023	FY 2024	FY 2025	FY 2026	FY 2027	FY 2028
Unit Volume	24,298	36,883	64,684	86,713	149,869	214,841	291,861	384,747	466,559	550,398	643,850	726,655	820,645	922,481	1,034,215	1,137,780
% Growth		52%	79%	34%	73%	43%	36%	32%	21%	18%	17%	13%	13%	12%	12%	10%
Automotive Revenue Per Unit (\$)	93,403	85,342	83,432	78,932	65,465	58,258	56,407	55,553	55,991	56,586	56,969	57,540	58,138	58,603	59,002	59,554
% Growth		-9%	-2%	-5%	-17%	-11%	-3%	-2%	1%	1%	1%	1%	1%	1%	1%	1%
Automotive Sales	2,462	3,321	5,613	7,051	10,025	12,720	16,685	21,595	26,347	31,357	36,897	42,022	47,949	54,283	61,221	67,980
Development Service Sales	16	40	42	44	46	49	51	54	56	59	62	65	68	72	75	79
Total Sales	2,478	3,361	5,655	7,095	10,072	12,768	16,736	21,648	26,403	31,416	36,959	42,087	48,017	54,355	61,296	68,059
% Growth		36%	60%	25%	42%	27%	31%	29%	22%	19%	18%	14%	14%	13%	13%	11%
EBITDA	148	417	920	1,042	1,586	2,150	3,138	4,066	4,857	5,723	6,328	7,182	8,144	9,688	10,874	12,099
% Margin	6.0%	12.4%	16.3%	14.7%	15.7%	16.8%	18.7%	18.8%	18.4%	18.2%	17.1%	17.1%	17.0%	17.8%	17.7%	17.8%
D&A	103	158	172	203	301	353	389	537	606	696	811	938	1,088	1,260	1,451	1,661
% of Capex	41%	79%	59%	65%	62%	69%	78%	86%	79%	77%	79%	76%	76%	76%	76%	77%
EBIT	45	259	748	839	1,285	1,796	2,749	3,529	4,252	5,027	5,517	6,244	7,056	8,429	9,423	10,439
% Margin	1.8%	7.7%	13.2%	11.8%	12.8%	14.1%	16.4%	16.3%	16.1%	15.0%	14.9%	14.8%	14.7%	15.5%	15.4%	15.3%
Net Interest Income (Expense)	(27)	(1)	9	33	47	90	108	155	199	278	358	445	542	651	784	934
Other Income	28	0	0	0	0	0	0	0	0	0	0	0	0	0	0	0
Pretax Income	46	258	758	872	1,332	1,886	2,857	3,684	4,451	5,305	5,875	6,688	7,598	9,080	10,207	11,373
Income Taxes	3	2	14	34	86	262	462	641	807	1,003	1,134	1,317	1,470	1,761	2,028	2,323
% Effective Rate	6%	1%	2%	4%	6%	14%	16%	17%	18%	19%	19%	20%	19%	19%	20%	20%
Net Income	44	256	744	839	1,246	1,624	2,395	3,043	3,644	4,303	4,741	5,372	6,128	7,319	8,179	9,050
Plus																
After-tax Interest Expense (Income)	27	1	(9)	(33)	(47)	(90)	(108)	(154)	(199)	(278)	(357)	(444)	(541)	(650)	(782)	(932)
Depreciation of PP&E	103	158	172	203	301	353	389	537	606	696	811	938	1,088	1,260	1,451	1,661
Other	0	0	0	0	0	0	0	0	0	0	0	0	0	0	0	0
Less																
Change in Working Capital	(155)	(14)	(157)	(167)	(172)	(325)	(163)	(81)	(28)	(299)	(356)	(328)	(219)	(329)	(365)	(376)
% of Change in Sales		-2%	-7%	-12%	-6%	-12%	-4%	-2%	-1%	-6%	-6%	-6%	-4%	-5%	-5%	-6%
Capital Expenditures	250	200	312	312	486	510	497	623	765	906	1,078	1,236	1,437	1,660	1,898	2,149
% of Sales	10%	6%	6%	4%	5%	4%	3%	3%	3%	3%	3%	3%	3%	3%	3%	3%
Other	0	0	0	0	0	0	0	0	0	0	0	0	0	0	0	0
Unlevered Free Cash Flow	78	229	750	863	1,186	1,702	2,343	2,884	3,314	4,113	4,472	4,959	5,456	6,597	7,315	8,005

EBITDA	12,099
Sales	68,059
Net Debt (Cash)	(260)
Tesla Diluted Shares	142

Exit EBITDA High	12.0 x	Exit PPG High	5.0%	Exit P/Sales High	180%
Exit EBITDA Low	8.0 x	Exit PPG Low	3.0%	Exit P/Sales Low	130%

Discount Rate High	13.0%	FY Month of Valuation	1.0 (Beginning of this Month)
Discount Rate Low	9.0%	Month of FY End	12.0 (End of this Month)

STEP 3: CONNECT YOUR NARRATIVE TO KEY DRIVERS OF VALUE

The Uber narrative (June 2014)

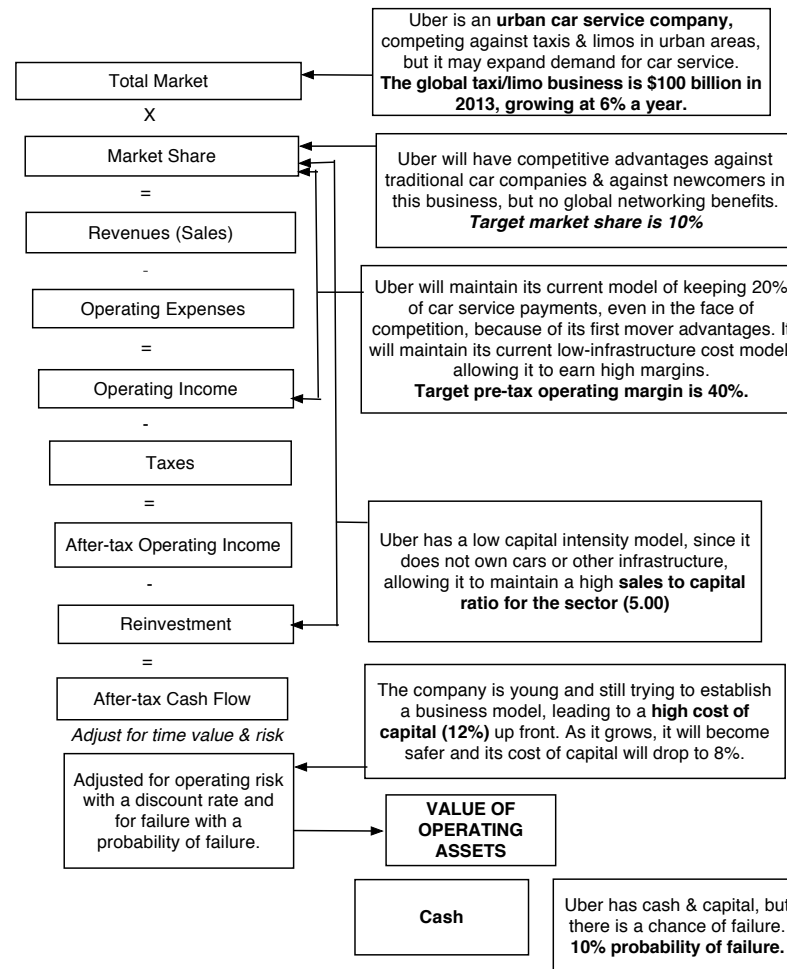

FERRARI: FROM STORY TO NUMBERS

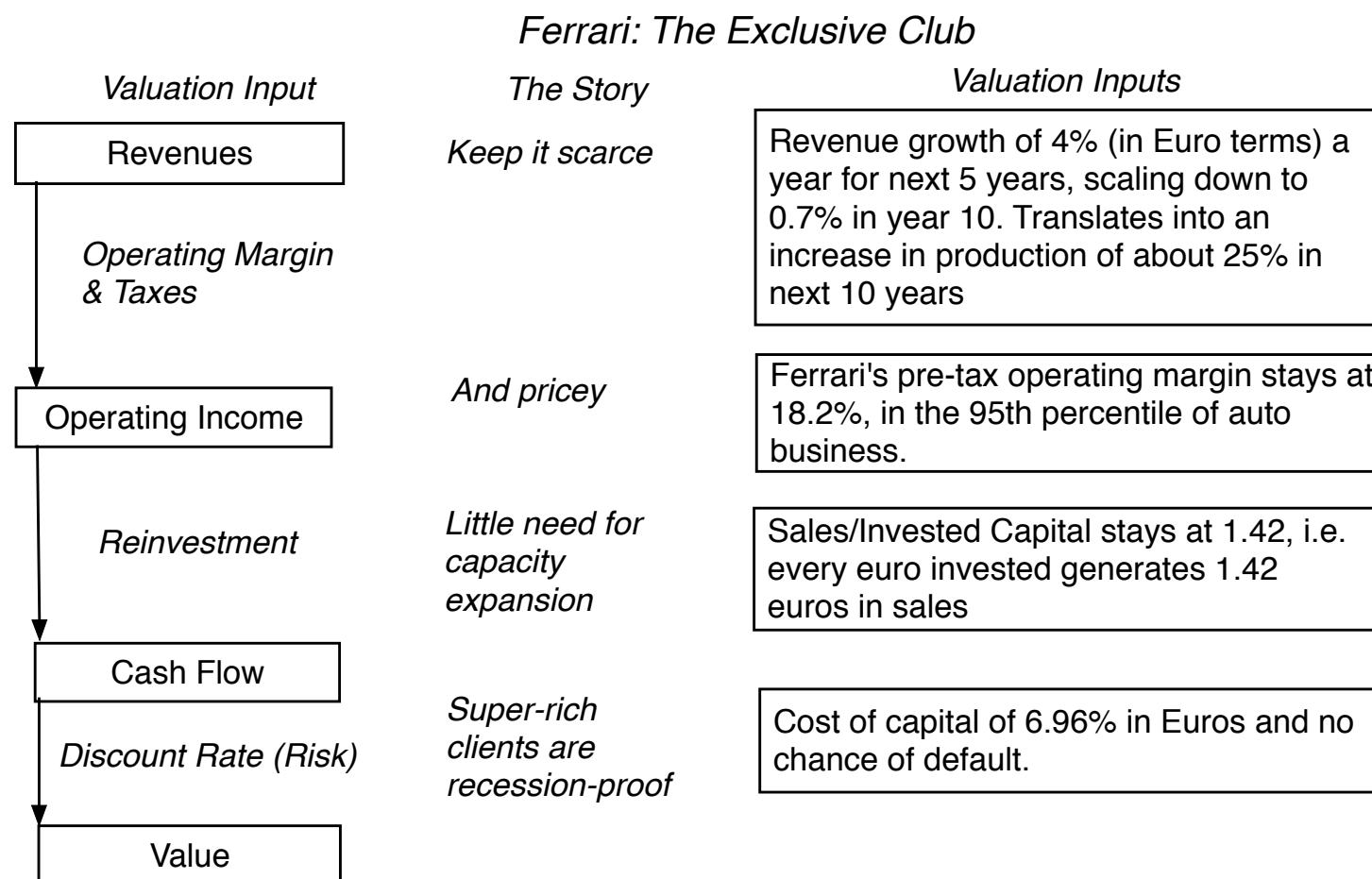

STEP 4: VALUE THE COMPANY (UBER)

Uber: Intrinsic valuation - June 8, 2014 (in US \$)

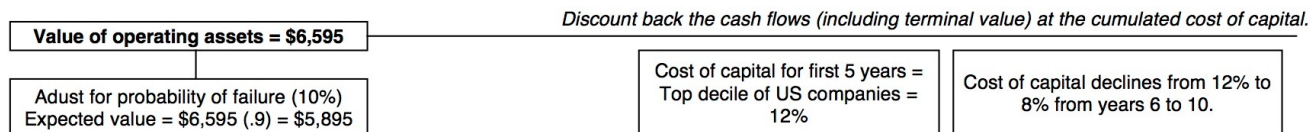
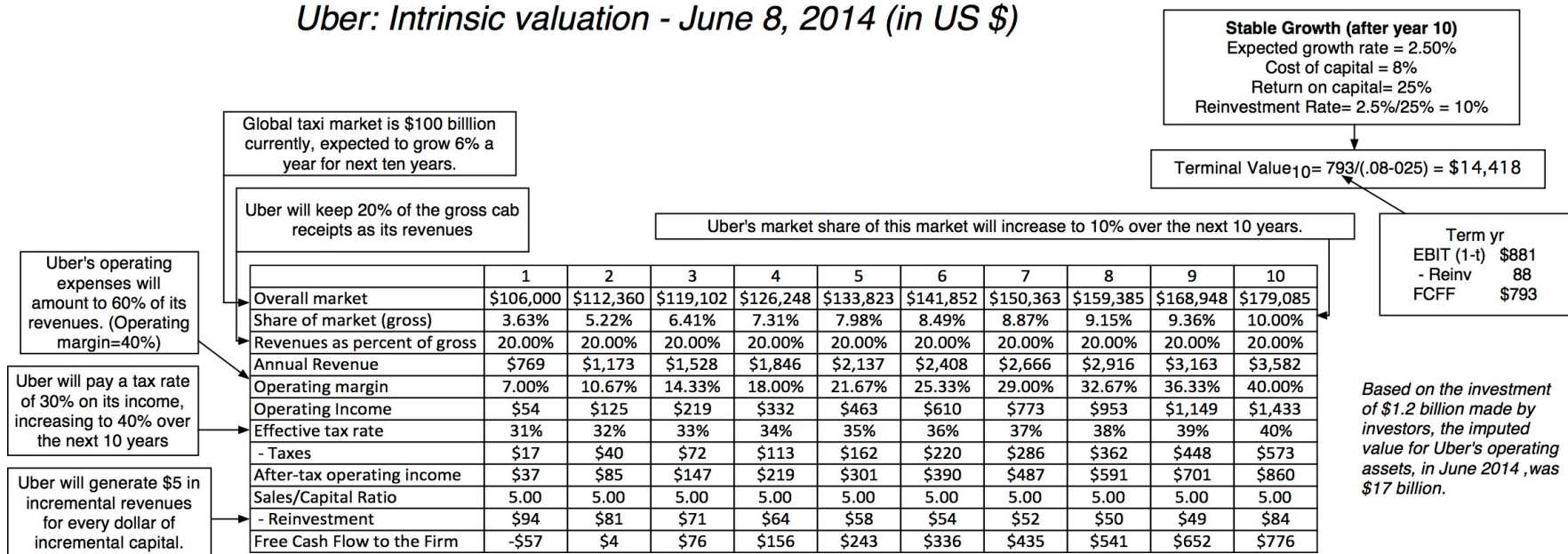

FERRARI: THE "EXCLUSIVE CLUB" VALUE

Stay Super Exclusive: Revenue growth is low

	Base year	1	2	3	4	5	6	7	8	9	10	Terminal year
Revenue growth rate		4.00%	4.00%	4.00%	4.00%	4.00%	3.34%	2.68%	2.02%	1.36%	0.70%	0.70%
Revenues	€ 2,763	€ 2,874	€ 2,988	€ 3,108	€ 3,232	€ 3,362	€ 3,474	€ 3,567	€ 3,639	€ 3,689	€ 3,714	€ 3,740
EBIT (Operating) margin	18.20%	18.20%	18.20%	18.20%	18.20%	18.20%	18.20%	18.20%	18.20%	18.20%	18.20%	18.20%
EBIT (Operating income)	€ 503	€ 523	€ 544	€ 566	€ 588	€ 612	€ 632	€ 649	€ 662	€ 671	€ 676	€ 681
Tax rate	33.54%	33.54%	33.54%	33.54%	33.54%	33.54%	33.54%	33.54%	33.54%	33.54%	33.54%	33.54%
EBIT(1-t)	€ 334	€ 348	€ 361	€ 376	€ 391	€ 407	€ 420	€ 431	€ 440	€ 446	€ 449	€ 452
- Reinvestment		€ 78	€ 81	€ 84	€ 87	€ 91	€ 79	€ 66	€ 51	€ 35	€ 18	€ 22
FCFF		€ 270	€ 281	€ 292	€ 303	€ 316	€ 341	€ 366	€ 389	€ 411	€ 431	€ 431
Cost of capital		6.96%	6.96%	6.96%	6.96%	6.96%	6.96%	6.97%	6.98%	6.99%	7.00%	7.00%
PV(FCFF)		€ 252	€ 245	€ 238	€ 232	€ 225	€ 228	€ 228	€ 227	€ 224	€ 220	
Terminal value	€ 6,835											
PV(Terminal value)	€ 3,485											
PV (CF over next 10 years)	€ 2,321											
Value of operating assets =	€ 5,806											
- Debt	€ 623											
- Minority interests	€ 13											
+ Cash	€ 1,141											
Value of equity	€ 6,311											

High Prices
+ No selling
cost =
Preserve
current
operating
margin

Minimal
Reinvestment
due to low
growth

The super
rich are not
sensitive to
economic
downturns

STEP 5: KEEP THE FEEDBACK LOOP

- **Not just car service company.:** Uber is a car company, not just a car service company, and there may be a day when consumers will subscribe to a Uber service, rather than own their own cars. It could also expand into logistics, i.e., moving and transportation businesses.
- **Not just urban:** Uber can create new demands for car service in parts of the country where taxis are not used (suburbia, small towns).
- **Global networking benefits:** By linking with technology and credit card companies, Uber can have global networking benefits.

VALUING BILL GURLEY'S UBER NARRATIVE

	<i>Uber (Gurley)</i>	<i>Uber (Gurley Mod)</i>	<i>Uber (Damodaran)</i>
Narrative	Uber will <u>expand the car service market substantially</u> , bringing in mass transit users & non-users from the suburbs into the market, and use its <u>networking advantage</u> to gain a <u>dominant market share</u> , while maintaining its revenue slice at 20%.	Uber will <u>expand the car service market substantially</u> , bringing in mass transit users & non-users from the suburbs into the market, and use its <u>networking advantage</u> to gain a <u>dominant market share</u> , while cutting prices and margins (to 10%).	Uber will expand the car service market moderately, primarily in urban environments, and use its <u>competitive advantages</u> to get a <u>significant but not dominant market share</u> and maintain its revenue slice at 20%.
Total Market	\$300 billion, growing at 3% a year	\$300 billion, growing at 3% a year	\$100 billion, growing at 6% a year
Market Share	40%	40%	10%
Uber's revenue slice	20%	10%	20%
Value for Uber	\$53.4 billion + Option value of entering car ownership market (\$10 billion+)	\$28.7 billion + Option value of entering car ownership market (\$6 billion+)	\$5.9 billion + Option value of entering car ownership market (\$2-3 billion)

DIFFERENT NARRATIVES, DIFFERENT NUMBERS

<i>Total Market</i>	<i>Growth Effect</i>	<i>Network Effect</i>	<i>Competitive Advantages</i>	<i>Value of Uber</i>
A4. Mobility Services	B4. Double market size	C5. Strong global network effects	D4. Strong & Sustainable	\$90,457
A3. Logistics	B4. Double market size	C5. Strong global network effects	D4. Strong & Sustainable	\$65,158
A4. Mobility Services	B3. Increase market by 50%	C3. Strong local network effects	D3. Semi-strong	\$52,346
A2. All car service	B4. Double market size	C5. Strong global network effects	D4. Strong & Sustainable	\$47,764
A1. Urban car service	B4. Double market size	C5. Strong global network effects	D4. Strong & Sustainable	\$31,952
A3. Logistics	B3. Increase market by 50%	C3. Strong local network effects	D3. Semi-strong	\$14,321
A1. Urban car service	B3. Increase market by 50%	C3. Strong local network effects	D3. Semi-strong	\$7,127
A2. All car service	B3. Increase market by 50%	C3. Strong local network effects	D3. Semi-strong	\$4,764
A4. Mobility Services	B1. None	C1. No network effects	D1. None	\$1,888
A3. Logistics	B1. None	C1. No network effects	D1. None	\$1,417
A2. All car service	B1. None	C1. No network effects	D1. None	\$1,094
A1. Urban car service	B1. None	C1. No network effects	D1. None	\$799

THE FERRARI COUNTER NARRATIVE

Ferrari: The Rev-it-up Option

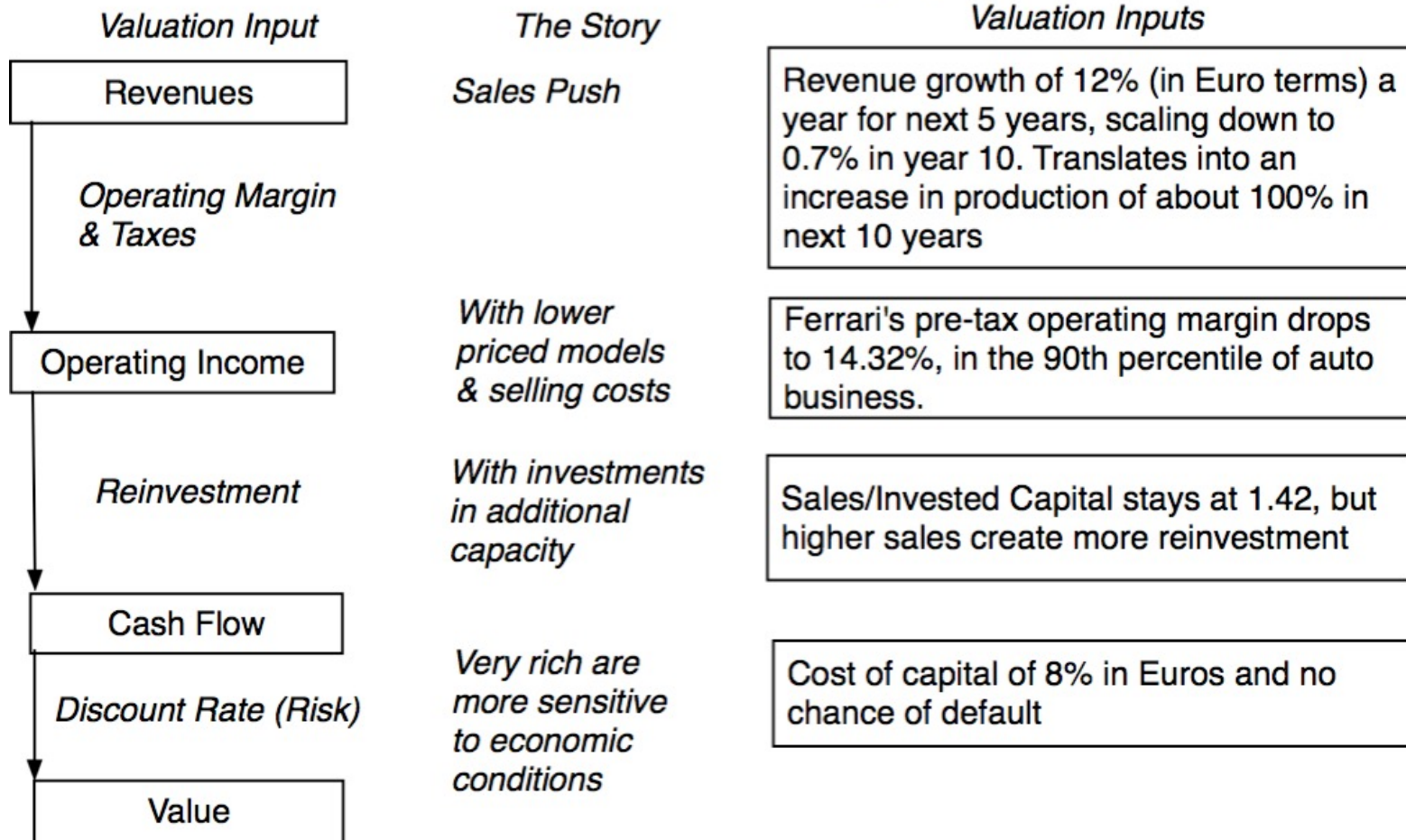

FERRARI: THE “REV-IT-UP” ALTERNATIVE

Get less exclusive: Double number of cars sold over next decade

	Base year	1	2	3	4	5	6	7	8	9	10	Terminal year
Revenue growth rate		12.00%	12.00%	12.00%	12.00%	12.00%	9.74%	7.48%	5.22%	2.96%	0.70%	0.70%
Revenues	€ 2,763	€ 3,095	€ 3,466	€ 3,882	€ 4,348	€ 4,869	€ 5,344	€ 5,743	€ 6,043	€ 6,222	€ 6,266	€ 6,309
EBIT (Operating) margin	18.20%	17.81%	17.42%	17.04%	16.65%	16.26%	15.87%	15.48%	15.10%	14.71%	14.32%	14.32%
EBIT (Operating income)	€ 503	€ 551	€ 604	€ 661	€ 724	€ 792	€ 848	€ 889	€ 912	€ 915	€ 897	€ 904
Tax rate	33.54%	33.54%	33.54%	33.54%	33.54%	33.54%	33.54%	33.54%	33.54%	33.54%	33.54%	33.54%
EBIT(1-t)	€ 334	€ 366	€ 401	€ 439	€ 481	€ 526	€ 564	€ 591	€ 606	€ 608	€ 596	€ 600
- Reinvestment		€ 233	€ 261	€ 293	€ 328	€ 367	€ 334	€ 281	€ 211	€ 126	€ 31	€ 35
FCFF		€ 133	€ 140	€ 147	€ 153	€ 159	€ 230	€ 310	€ 395	€ 482	€ 566	€ 565
Cost of capital		8.00%	8.00%	8.00%	8.00%	8.00%	7.90%	7.80%	7.70%	7.60%	7.50%	7.50%
PV(FCFF)		€ 123	€ 120	€ 117	€ 113	€ 108	€ 145	€ 181	€ 215	€ 244	€ 266	
Terminal value	€ 8,315											
PV(Terminal value)	€ 3,906											
PV (CF over next 10 years)	€ 1,631											
Value of operating assets =	€ 5,537											
- Debt	€ 623											
- Minority interests	€ 13											
+ Cash	€ 1,141											
Value of equity	€ 6,042											

Lower Prices +
Some selling cost = Lower operating margin

Reinvestment reflects higher sales

The very rich are more sensitive to economic conditions

AND THE WORLD IS FULL OF FEEDBACK.. MY FERRARI AFTERTHOUGHT!



ZOMATO IPO: ALTERNATE STORIES (AND VALUES)

Story	TAM (in ₹ millions)	Market Share	Revenue Slice	Target Margin	Cost of Capital	Value/share	
Delivery Juggernaut	₹ 5,000,000.00	40%	25%	45%	9.50%	₹ 150.02	Plausible
Delivery Star	₹ 5,000,000.00	40%	22%	35%	9.50%	₹ 93.00	
Delivery Leader + Competition	₹ 5,000,000.00	40%	15%	35%	10.99%	₹ 61.55	
Restaurant Delivery Juggernaut + High Growth India	₹ 3,000,000.00	40%	25%	45%	9.50%	₹ 94.31	Probable
Restaurant Delivery Star + High Growth India	₹ 3,000,000.00	40%	22%	35%	9.50%	₹ 59.02	
Restaurant Delivery + Competition + High Growth India	₹ 3,000,000.00	40%	20%	25%	10.99%	₹ 35.52	
Base Case, Positive	₹ 2,000,000.00	40%	25%	45%	10.25%	₹ 56.66	
Base Case	₹ 2,000,000.00	40%	22%	35%	10.25%	₹ 39.48	
Base Case, Negative	₹ 2,000,000.00	40%	20%	25%	10.25%	₹ 26.16	
Restaurant Delivery Juggernaut + Low Growth India	₹ 1,125,000.00	40%	25%	45%	9.50%	₹ 36.48	Plausible
Restaurant Delivery Star + Low Growth India	₹ 1,125,000.00	40%	22%	35%	9.50%	₹ 24.02	
Restaurant Delivery + Competition + low Growth India	₹ 1,125,000.00	40%	20%	25%	10.99%	₹ 16.58	

STEP 6: BE READY TO MODIFY NARRATIVE AS EVENTS UNFOLD

Narrative Break/End	Narrative Shift	Narrative Change (Expansion or Contraction)
Events, external (legal, political or economic) or internal (management, competitive, default), that can cause the narrative to break or end.	Improvement or deterioration in initial business model, changing market size, market share and/or profitability.	Unexpected entry/success in a new market or unexpected exit/failure in an existing market.
Your valuation estimates (cash flows, risk, growth & value) are no longer operative	Your valuation estimates will have to be modified to reflect the new data about the company.	Valuation estimates have to be redone with new overall market potential and characteristics.
Estimate a probability that it will occur & consequences	Monte Carlo simulations or scenario analysis	Real Options



PRICING 101

Price \neq Value

Aswath Damodaran

RELATIVE VALUATION IS PERVASIVE...

- Much of what passes for valuation is pricing.
- Most “valuations” on Wall Street are pricing.
 - Almost 85% of equity research reports are based upon a multiple and comparable firms.
 - More than 50% of all acquisition valuations are based upon multiples.
 - Rules of thumb based on multiples are not only common but are often the basis for final valuation judgments.
- While there are more discounted cashflow valuations in consulting and corporate finance, they are often relative valuations masquerading as discounted cash flow valuations.
 - The objective in many discounted cashflow valuations is to back into a number that has been obtained by using a multiple.
 - The terminal value in a significant number of discounted cashflow valuations is estimated using a multiple.

WHY RELATIVE VALUATION?

- “If you think I’m crazy, you should see the guy who live the hall”

Jerry Seinfeld talking about Kramer in a Seinfeld epis



Michael Richards
Photo: George Lange

©NBC, Inc.

“ A little inaccuracy sometimes saves tons of explanation”

H.H. Munro

“ If you are going to screw up, make sure that you have lots of company”

Ex-portfolio manager

PRICING VERSUS VALUATION

- Drivers of intrinsic value
- Cashflows from existing assets
 - Growth in cash flows
 - Quality of Growth

- Drivers of price
- Market moods & momentum
 - Surface stories about fundamentals

Accounting Estimates

Valuation Estimates

INTRINSIC VALUE

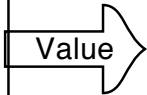

THE GAP
Is there one?
If so, will it close?
If it will close, what will cause it to close?



PRICE

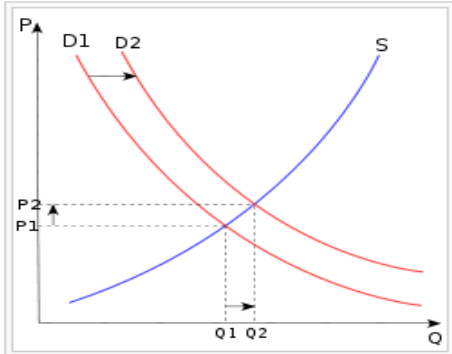

TEST 1: ARE YOU PRICING OR VALUING?



5369 La Jolla Mesa Dr
La Jolla, CA 92037
Status: Active

\$995,000
Price

3
Beds

2.5
Baths

1,440 Sq. Ft.
\$691 / Sq. Ft.

Built: 1955 Lot Size: 3,000 Sq. Ft. On Redfin: 12 days



Favorite



X-Out



Share...



Tour Home

Overview

Property Details

Tour Insights

Property History

Public Records

Activity

Schools

Neighborhood & Offer Insights

Similar Homes

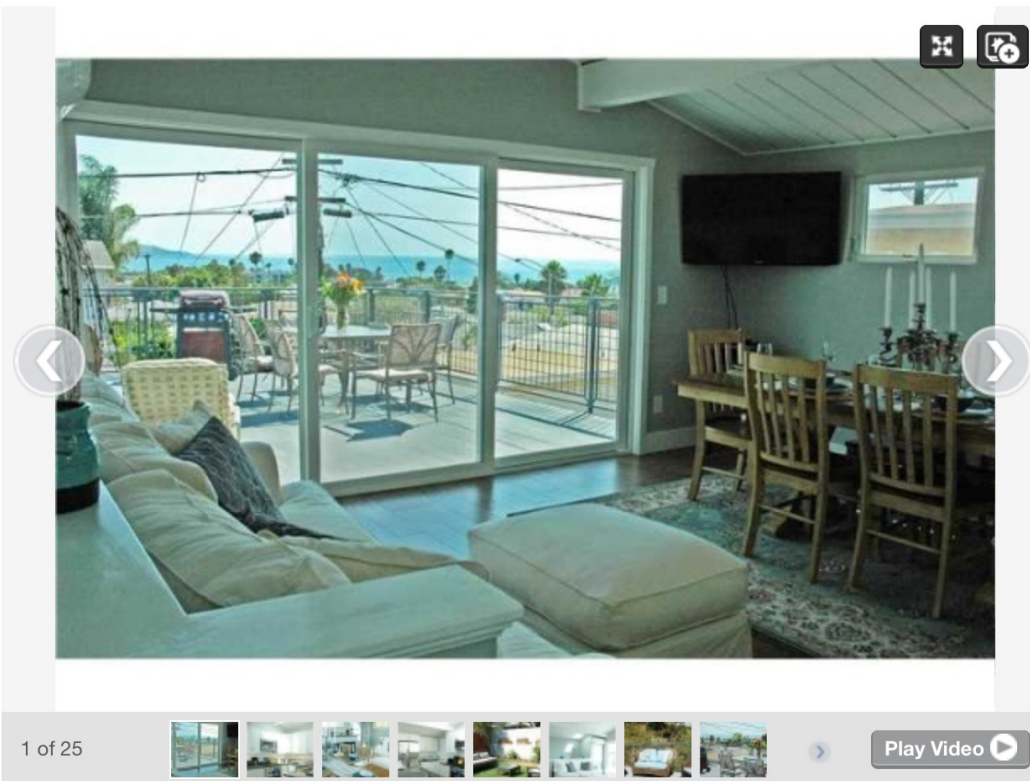

1 of 25

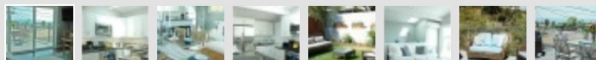

Play Video

Lisa Padilla

REDFIN Real Estate Agent

★★★★★
47 client reviews

\$8,726 commission refund

Go Tour This Home

Ask Lisa a Question or Start an Offer



1 of 4 Redfin Agents in this area

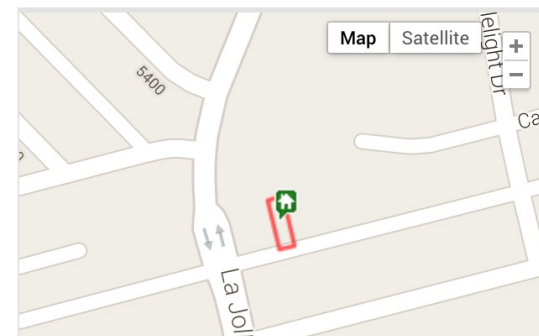

TEST 2: ARE YOU PRICING OR VALUING?

Rating
Buy

Europe
Switzerland

Biotechnology
Biotechnology

Company
BB BIOTECH

Reuters
BION.S

Bloomberg
BION SW

Exchange
SWX

Ticker
BION

Date
13 August 2013

Forecast Change

Price at 12 Aug 2013 (CHF) 124.00

Price Target

52-week

Holger B

Research

(+41) 44 227-3376

(+49) 69 910-31917

holger.blum@db.com

gunnar.romer@db.com

Strong sector and stock-picking continue

Impressive performance

Over the past two years, BB Biotech shares have roughly tripled, which could tempt investors to take profits. However, this performance has been well backed by a deserved revival of the biotech industry, encouraging fundamental news, M&A, and increased money flow into health care stocks. In addition, BBB returned to index outperformance by modifying its stock-picking approach. Hence, despite excellent performance, the shares still trade at a 23% discount to the net asset value of the portfolio. Hence, the shares are an attractive value vehicle to capture growth opportunities in an attractive sector.

Biotech industry remains attractive

With the re-rating of the pharma sector, investors have also showed increased interest in biotech stocks. Established biotech stocks have delivered encouraging financial results and approvals, while there has also been substantial industry consolidation, which is not surprising in times of "cheap" money and high liquidity. BB Biotech remains an attractive vehicle to capture the future potential of the biotech sector. In addition, investors benefit from a 23% discount to NAV and attractive cash distribution policy of 5% yield p.a. Hence, we reiterate our Buy on BB Biotech shares.

BB Biotech shares remain attractive

In the first 6M of 2013, BB Biotech increased its NAV by 36%, which marks good outperformance against the Nasdaq Biotech Index (NBI)'s 27%. This is a remarkable performance after 2012 when BBB's NAV increase of 45% also

Key changes

Target Price 106.50 to 164.50 ↑ 54.5%

Source: Deutsche Bank

Price/price relative

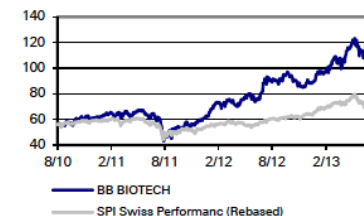

Performance (%)	1m	3m	12m
Absolute	-1.4	5.4	37.4
SPI Swiss Performance IX	0.5	-1.4	26.4

Source: Deutsche Bank

THE TOOL FOR PRICING: A MULTIPLE

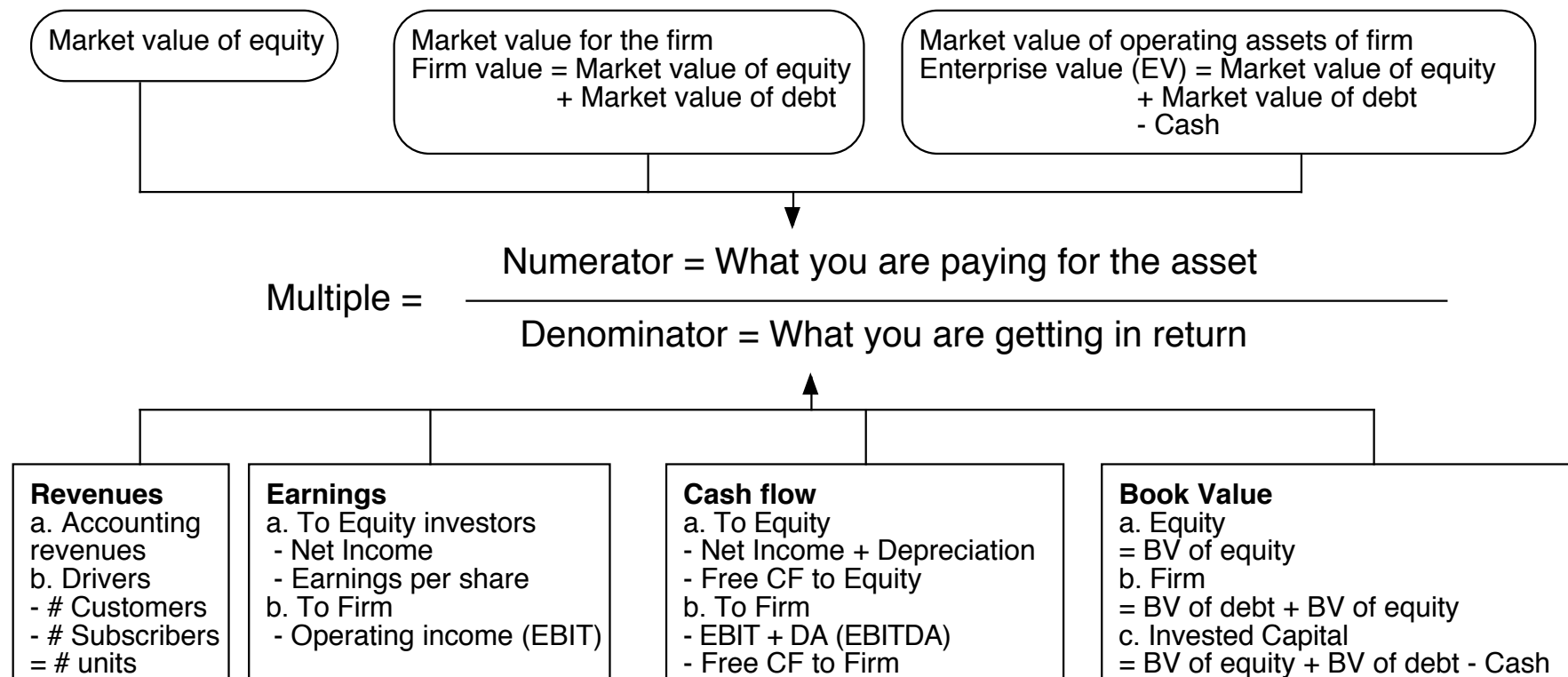

THE FOUR STEPS TO DECONSTRUCTING MULTIPLES

- Define the multiple
 - In use, the same multiple can be defined in different ways by different users. In pricing, it is key that the multiple be **consistently defined** and **uniformly estimated**.
- Describe the multiple
 - Too many people who use a multiple have no idea what its cross sectional distribution is, using rules of thumb for what is cheap or expensive. Instead, **use all of the data** to develop perspective on what is low or high.
- Analyze the multiple
 - It is critical that we **understand the fundamentals** that drive each multiple, and the nature of the relationship between the multiple and each variable.
- Apply the multiple
 - **Defining the comparables** and controlling for differences is far more difficult in practice than it is in theory.

DEFINITIONAL TESTS

- Is the multiple consistently defined?
 - **Proposition 1:** Both the value (the numerator) and the standardizing variable (the denominator) **should be to the same claimholders in the firm.** In other words, the value of equity should be divided by equity earnings or equity book value, and firm value should be divided by firm earnings or book value.
- Is the multiple uniformly estimated?
 - The variables used in defining the multiple should be estimated **uniformly across assets** in the “comparable firm” list.
 - If earnings-based multiples are used, the **accounting rules to measure earnings should be applied consistently** across assets. The same rule applies with book-value based multiples.

EXAMPLE 1: PRICE EARNINGS RATIO: DEFINITION

- $PE = \text{Market Price per Share} / \text{Earnings per Share}$
 - There are a **number of variants on the basic PE ratio in use**. They are based upon how the price and the earnings are defined.
 - Price: is usually the current price
 - is sometimes the average price for the year
- EPS: EPS in most recent financial year
- EPS in trailing 12 months (Trailing PE)
- Forecasted EPS for next year (Forward PE)
- Forecasted EPS in future year

EXAMPLE 2: ENTERPRISE VALUE / EBITDA MULTIPLE

- The enterprise value to EBITDA multiple is obtained by netting cash out against debt to arrive at enterprise value and dividing by EBITDA.

$$\frac{\text{Enterprise Value}}{\text{EBITDA}} = \frac{\text{Market Value of Equity} + \text{Market Value of Debt} - \text{Cash}}{\text{Earnings before Interest, Taxes and Depreciation}}$$

- Why do we **net out cash** from firm value?
- What happens if a firm has cross holdings which are categorized as:
 - Minority interests?
 - Majority active interests?

DESCRIPTIVE TESTS

- What is the **average and standard deviation** for this multiple, across the universe (market)?
- What is the **median** for this multiple?
 - The median for this multiple is often a more reliable comparison point.
- How **large are the outliers to the distribution**, and how do we deal with the outliers?
 - Throwing out the outliers may seem like an obvious solution, but if the outliers all lie on one side of the distribution (they usually are large positive numbers), this can lead to a biased estimate.
- Are there cases **where the multiple cannot be estimated**? Will ignoring these cases lead to a biased estimate of the multiple?
- How has this multiple **changed over time**?

1. MULTIPLES HAVE SKEWED DISTRIBUTIONS...

PE Ratios at the start of 2025: United States

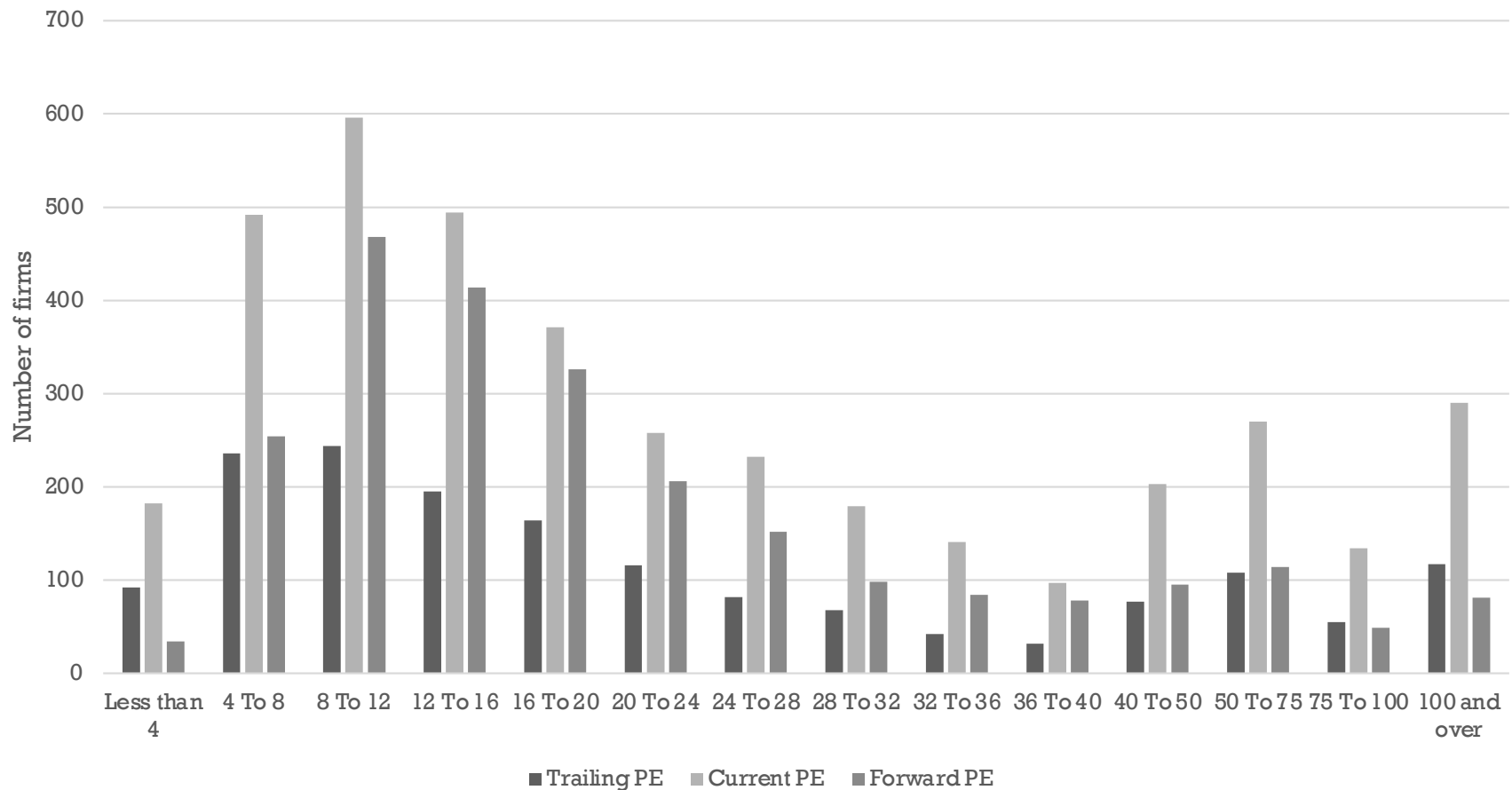

2. MAKING STATISTICS “DICEY”

	<i>Current PE</i>	<i>Trailing PE</i>	<i>Forward PE</i>
Sample Size	6062	6062	6062
# firms	2607	2576	2339
Average	57.11	48.86	31.6
Minimum	0.03	0.04	1.41
First Quartile	10.61	11.43	11.65
Median	18.66	18.73	17.24
Third Quartile	35.12	33.17	27.26
Maximum	7900	9489	3825
Skewness	15.92	26.45	23.62

3. MARKETS HAVE A LOT IN COMMON : COMPARING GLOBAL PES

PE Ratios in January 2025: US and Global Stocks

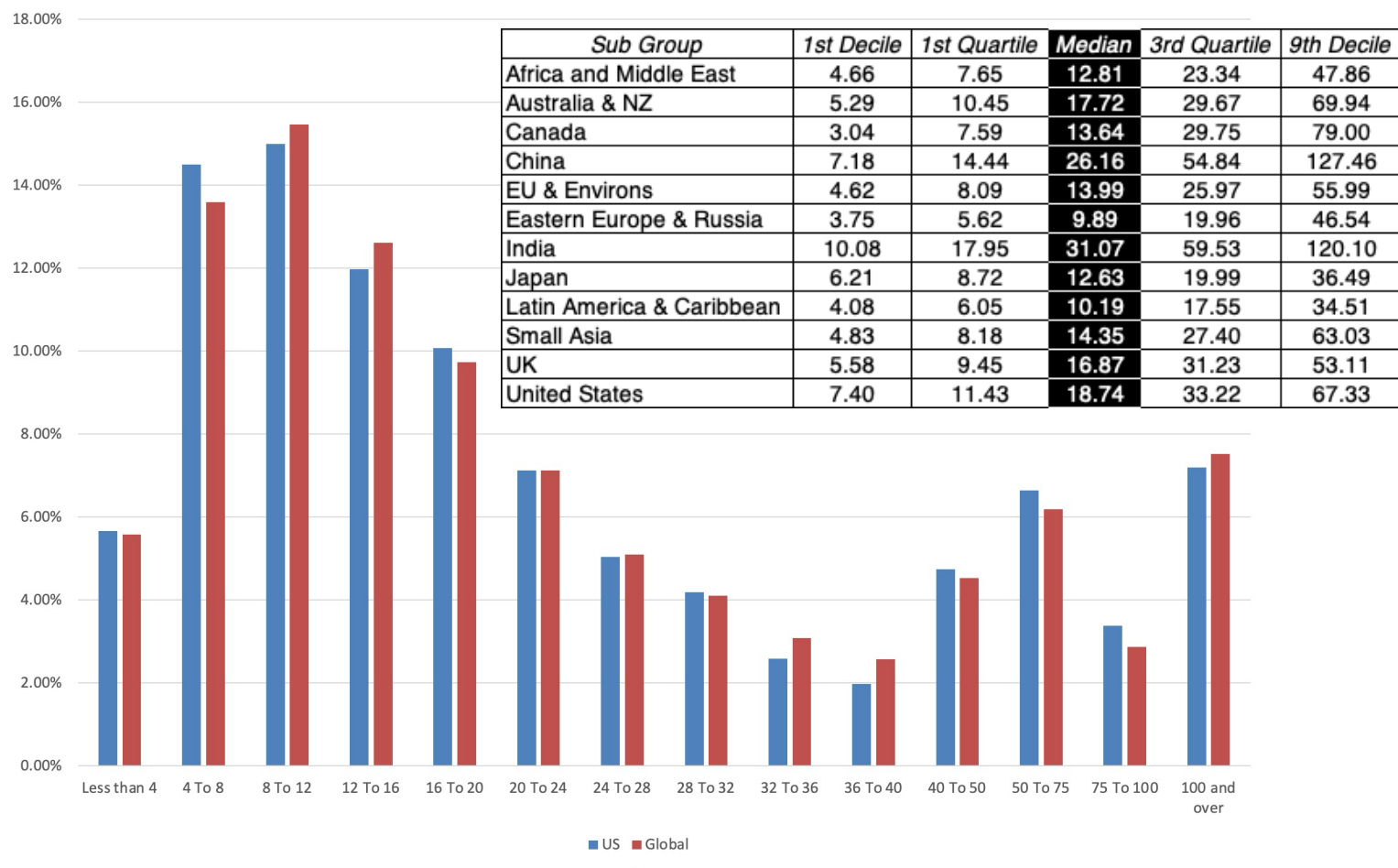

4. SIMPLISTIC RULES ALMOST ALWAYS BREAK DOWN... 6 TIMES EBITDA WAS NOT CHEAP IN THE US IN 2010

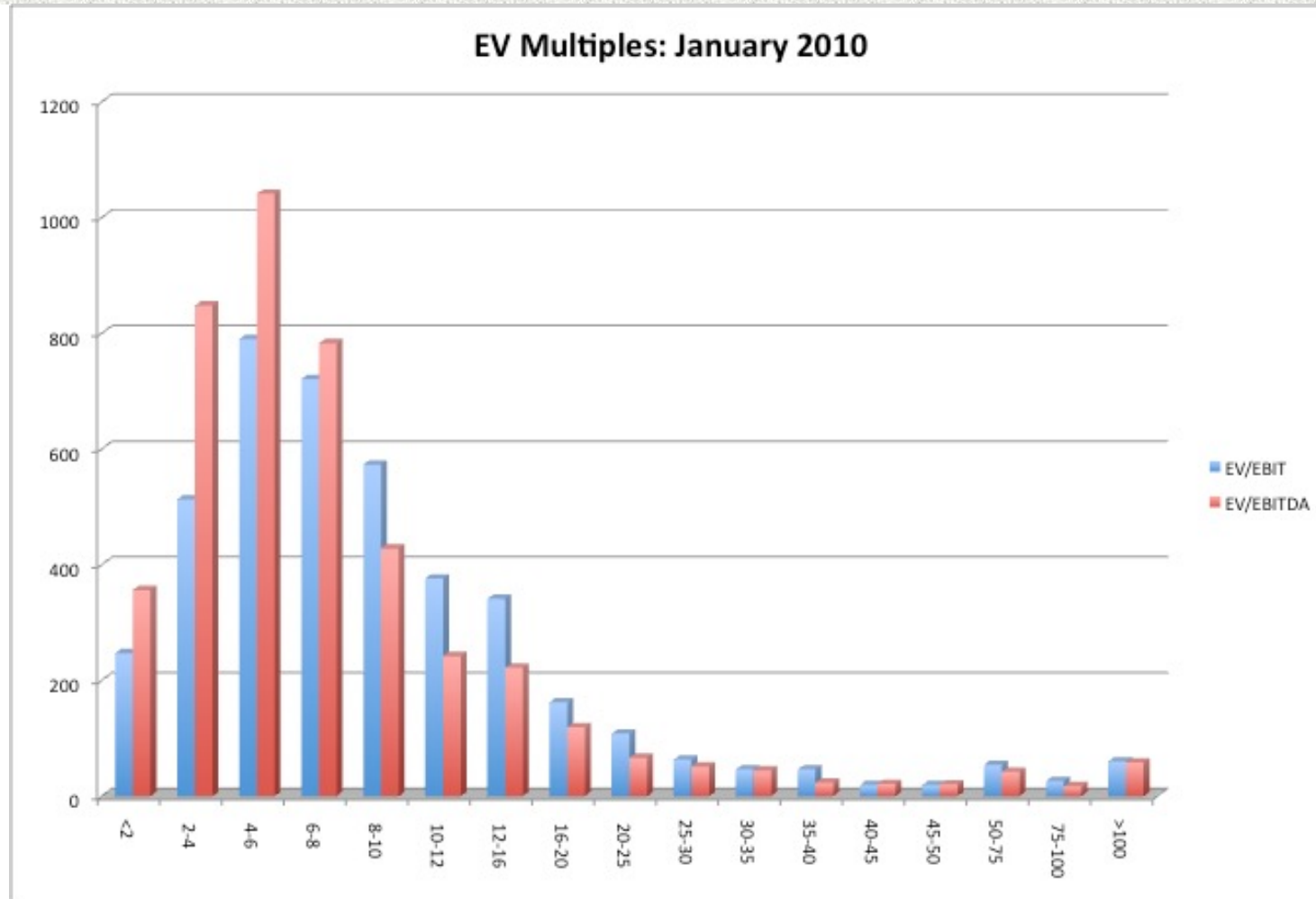

BUT IT MAY BE IN 2024, UNLESS YOU IN JAPAN OR RUSSIA...

EV to EBITDA in January 2025

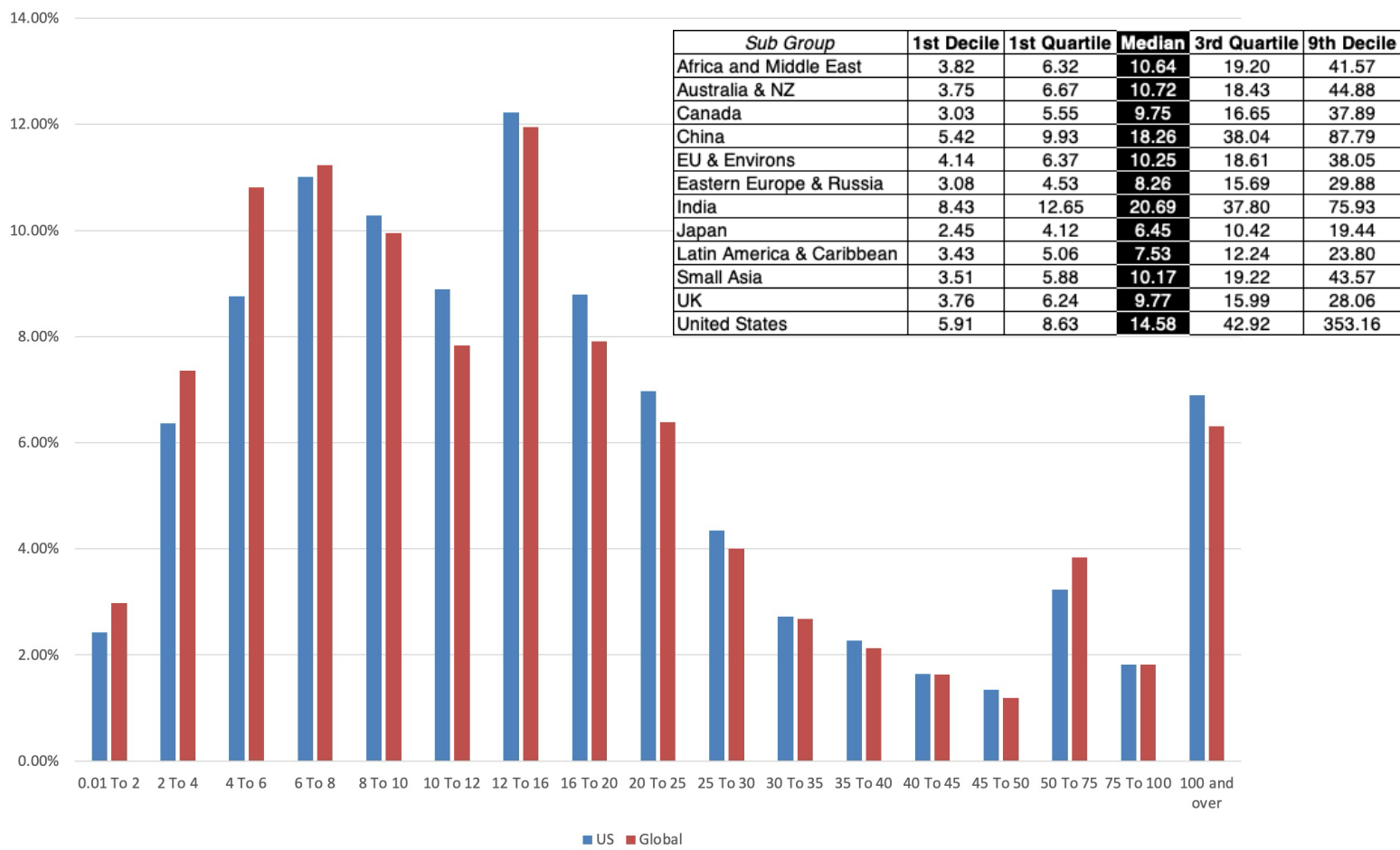

ANALYTICAL TESTS

- What are the **fundamentals** that determine and drive these multiples?
 - **Proposition 2:** Embedded in every multiple are **all of the variables that drive every discounted cash flow valuation** - growth, risk and cash flow patterns.
 - In fact, using a simple discounted cash flow model and basic algebra should yield the fundamentals that drive a multiple
- How do changes in these fundamentals change the multiple?
 - The relationship between a fundamental (like growth) and a multiple (such as PE) is **seldom linear**. For example, if firm A has twice the growth rate of firm B, it will generally not trade at twice its PE ratio
 - **Proposition 3:** It is **impossible to properly compare firms on a multiple**, if we do not know the **nature of the relationship** between fundamentals and the multiple.

A SIMPLE ANALYTICAL DEVICE

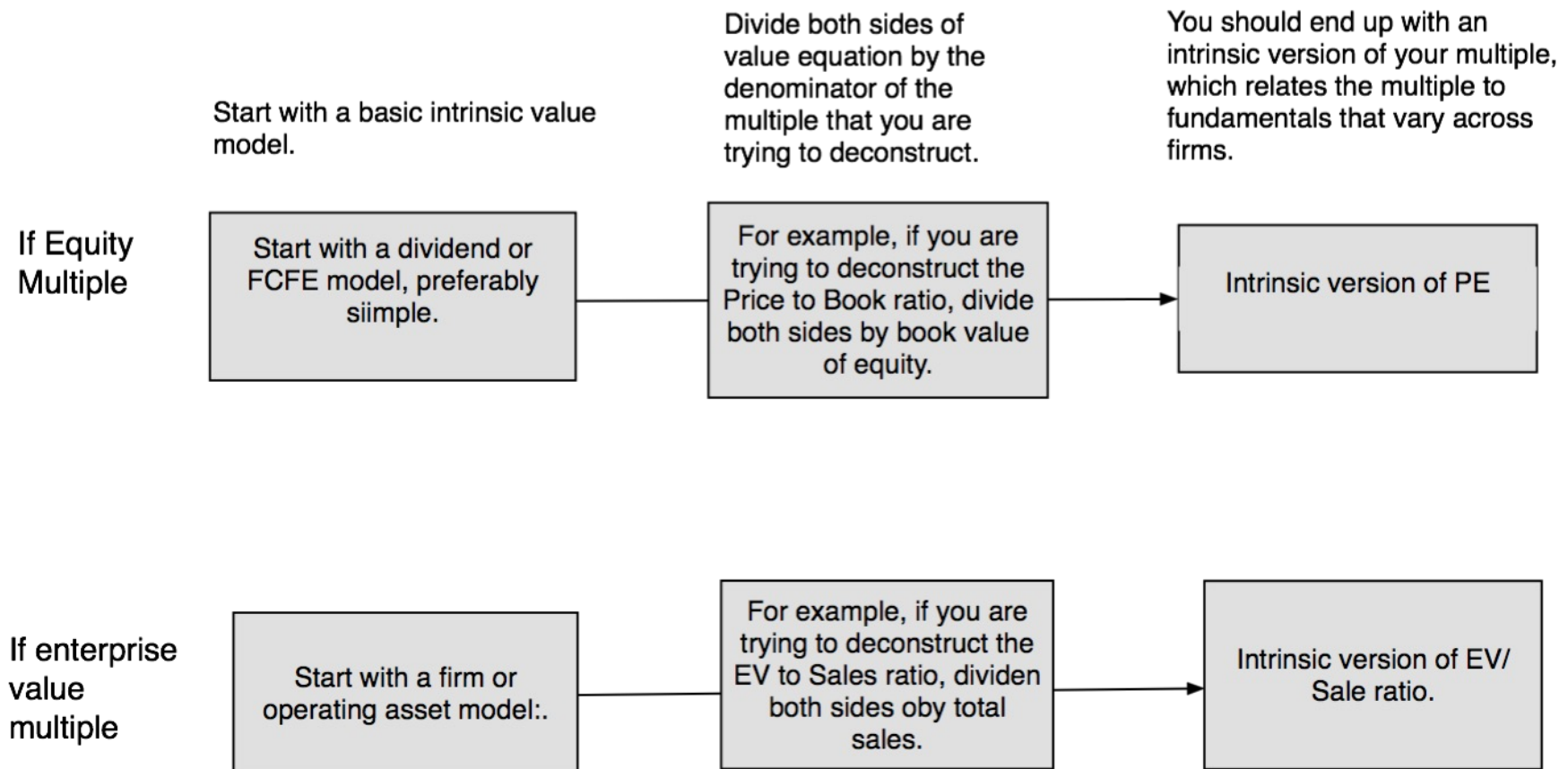

PE RATIO: UNDERSTANDING THE FUNDAMENTALS

- To understand the fundamentals, start with a basic equity discounted cash flow model.
- With the dividend discount model,

$$P_0 = \frac{DPS_1}{r - g_n}$$

- Dividing both sides by the current earnings per share,

$$\frac{P_0}{EPS_0} = PE = \frac{\text{Payout Ratio} * (1 + g_n)}{r - g_n}$$

- If this had been a FCFE Model,

$$P_0 = \frac{FCFE_1}{r - g_n}$$

$$\frac{P_0}{EPS_0} = PE = \frac{(FCFE/\text{Earnings}) * (1 + g_n)}{r - g_n}$$

THE DETERMINANTS OF MULTIPLES . . .

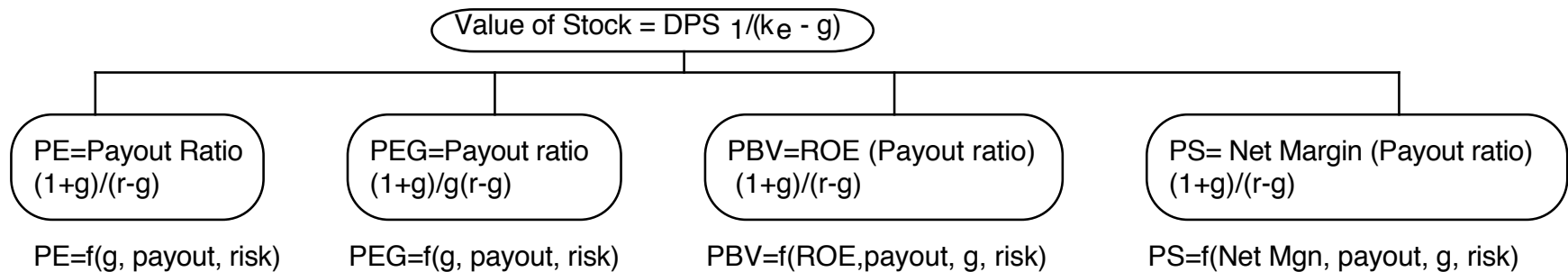

Equity Multiples

Firm Multiples

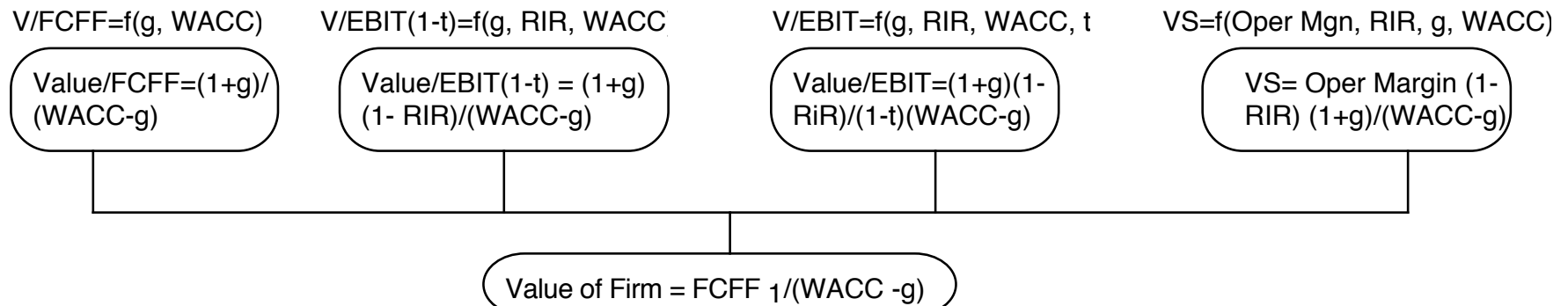

APPLICATION TESTS

- Given the firm that we are valuing, **what is a “comparable” firm?**
 - While traditional analysis is built on the premise that **firms in the same sector** are comparable firms, valuation theory would suggest that a comparable firm is one which is similar to the one being analyzed in terms of fundamentals.
 - **Proposition 4:** There is no reason why a firm cannot be compared with another firm in a very different business, if the two firms have the **same risk, growth and cash flow characteristics.**
- Given the comparable firms, how do we adjust for differences across firms on the fundamentals?
 - **Proposition 5:** It is **impossible to find an exactly identical firm** to the one you are valuing.

AN EXAMPLE: COMPARING PE RATIOS ACROSS A SECTOR: PE

<i>Company Name</i>	<i>PE</i>	<i>Growth</i>
<i>PT Indosat ADR</i>	<i>7.8</i>	<i>0.06</i>
<i>Telebras ADR</i>	<i>8.9</i>	<i>0.075</i>
<i>Telecom Corporation of New Zealand ADR</i>	<i>11.2</i>	<i>0.11</i>
<i>Telecom Argentina Stet - France Telecom SA ADR B</i>	<i>12.5</i>	<i>0.08</i>
<i>Hellenic Telecommunication Organization SA ADR</i>	<i>12.8</i>	<i>0.12</i>
<i>Telecomunicaciones de Chile ADR</i>	<i>16.6</i>	<i>0.08</i>
<i>Swisscom AG ADR</i>	<i>18.3</i>	<i>0.11</i>
<i>Asia Satellite Telecom Holdings ADR</i>	<i>19.6</i>	<i>0.16</i>
<i>Portugal Telecom SA ADR</i>	<i>20.8</i>	<i>0.13</i>
<i>Telefonos de Mexico ADR L</i>	<i>21.1</i>	<i>0.14</i>
<i>Matav RT ADR</i>	<i>21.5</i>	<i>0.22</i>
<i>Telstra ADR</i>	<i>21.7</i>	<i>0.12</i>
<i>Gilat Communications</i>	<i>22.7</i>	<i>0.31</i>
<i>Deutsche Telekom AG ADR</i>	<i>24.6</i>	<i>0.11</i>
<i>British Telecommunications PLC ADR</i>	<i>25.7</i>	<i>0.07</i>
<i>Tele Danmark AS ADR</i>	<i>27</i>	<i>0.09</i>
<i>Telekomunikasi Indonesia ADR</i>	<i>28.4</i>	<i>0.32</i>
<i>Cable & Wireless PLC ADR</i>	<i>29.8</i>	<i>0.14</i>
<i>APT Satellite Holdings ADR</i>	<i>31</i>	<i>0.33</i>
<i>Telefonica SA ADR</i>	<i>32.5</i>	<i>0.18</i>
<i>Royal KPN NV ADR</i>	<i>35.7</i>	<i>0.13</i>
<i>Telecom Italia SPA ADR</i>	<i>42.2</i>	<i>0.14</i>
<i>Nippon Telegraph & Telephone ADR</i>	<i>44.3</i>	<i>0.2</i>
<i>France Telecom SA ADR</i>	<i>45.2</i>	<i>0.19</i>
<i>Korea Telecom ADR</i>	<i>71.3</i>	<i>0.44</i>

COMPARISONS TO THE ENTIRE MARKET: WHY NOT?

- In contrast to the 'comparable firm' approach, the information in the entire cross-section of firms can be used to predict PE ratios.
- The simplest way of summarizing this information is with a multiple regression, with the PE ratio as the dependent variable, and proxies for risk, growth and payout forming the independent variables.
- While there will be significant variation across the companies in the sample, the sample size will be large enough to yield statistical significance.

PE RATIO VERSUS THE MARKET

PE VERSUS EXPECTED EPS GROWTH: JANUARY 2025

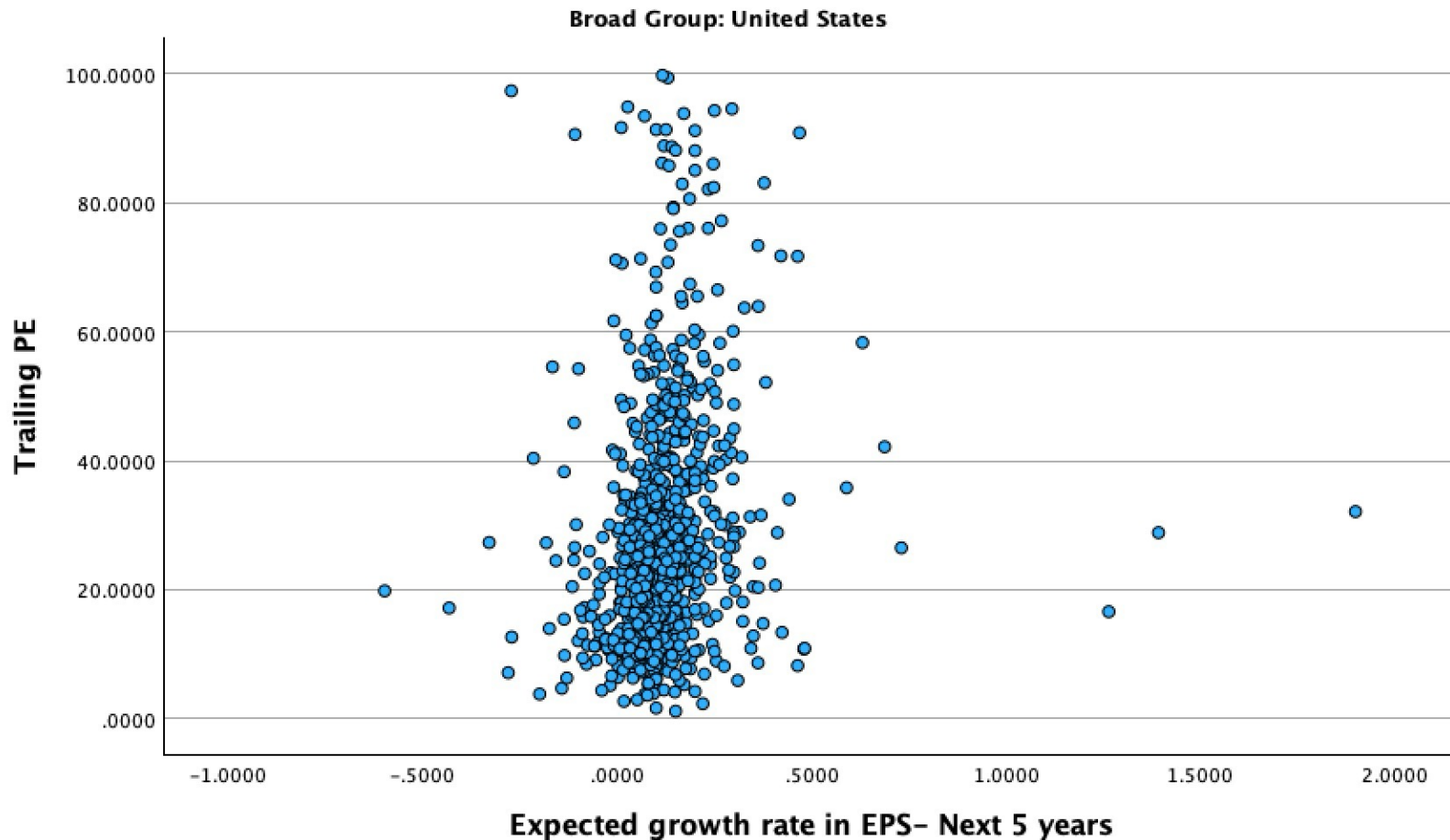

PE RATIO: STANDARD REGRESSION FOR US STOCKS - JANUARY 2025

Model Summary^a

Model	R	R Square	Adjusted R Square	Std. Error of the Estimate
1	.496 ^b	.246	.244	2951.48154

a. Broad Group = United States

b. Predictors: (Constant), Beta, Expected growth rate in EPS- Next 5 years, Payout ratio

The regression is run with growth and payout entered as decimals, i.e., 25% is entered as 0.25)

Coefficients^{a,b,c}

Model		Unstandardized Coefficients		Standardized Coefficients	t	Sig.
		B	Std. Error	Beta		
1	(Constant)	16.085	1.472		10.928	<.001
	Expected growth rate in EPS- Next 5 years	51.916	4.386	.380	11.836	<.001
	Payout ratio	7.531	1.233	.196	6.107	<.001
	Beta	9.298	1.364	.242	6.817	<.001

a. Broad Group = United States

b. Dependent Variable: Trailing PE

c. Weighted Least Squares Regression – Weighted by Market Cap (in US \$)

PE RATIO REGRESSIONS ACROSS MARKETS

⚓ Market-wide Regressions of Multiples: PE Ratios in January 2025
T statistics in brackets below coefficients

Regression	R Squared	Region
$PE = 16.09 + 9.30 \text{ Beta} + 51.92 g_{EPS} + 7.53 \text{ Payout}$ (0.93) (6.82) (11.84) (6.11)	24.4%	US
$PE = 12.58 + 3.70 \text{ Beta} + 45.97 g_{EPS} + 6.97 \text{ Payout}$ (8.70) (4.65) (9.57) (8.48)	16.0%	Europe
$PE = 8.63 + 3.72 \text{ Beta} + 38.36 g_{EPS} + 5.99 \text{ Payout}$ (5.43) (4.66) (7.77) (3.44)	26.4%	Japan
$PE = 4.28 + 13.96 \text{ Beta} + 72.58 g_{EPS} + 4.08 \text{ Payout}$ (1.47) (7.40) (8.64) (1.79)	46.0%	Aus, NZ & Canada
$PE = 23.41 - 1.84 \text{ Beta} + 33.66 g_{EPS} - 2.30 \text{ Payout}$ (20.51) (3.63) (14.62) (2.46)	13.2%	Emerging Markets
$PE = 24.17 - 1.07 \text{ Beta} + 53.16 g_{EPS} + 1.08 \text{ Payout}$ (38.48) (2.65) (27.59) (2.05)	16.0%	Global

g_{EPS} = Expected Growth: Expected growth in EPS or Net Income: Next 5 years (decimals)

Beta: Regression or Bottom up Beta

Payout ratio: Dividends/ Net income from most recent year. Set to zero, if net income < 0

CHOOSING BETWEEN THE MULTIPLES

- As presented in this section, there are **dozens of multiples that can be potentially used** to value an individual firm.
- In addition, relative valuation can be **relative to a sector (or comparable firms) or to the entire market** (using the regressions, for instance)
- Since there can be only one final estimate of value, there are three choices at this stage:
 - Use a **simple average of the pricing** obtained using a number of different multiples
 - Use a **weighted average of the pricing** obtained using a number of different multiples
 - Choose **one of the multiples** and base your valuation on that multiple

PICKING ONE MULTIPLE

- This is usually the best way to approach this issue. While a range of values can be obtained from a number of multiples, the “best estimate” value is obtained using one multiple.
- The multiple that is used can be chosen in one of two ways:
 - **The Cynic:** Use the multiple that best fits your objective. Thus, if you want the company to be undervalued, you pick the multiple that yields the highest value.
 - **The Quant:** Use the multiple that has the **highest R-squared** in the sector when regressed against fundamentals. Thus, if you have tried PE, PBV, PS, etc. and run regressions of these multiples against fundamentals, use the multiple that works best at explaining differences across firms in that sector.
 - **The Business Imperative:** Use the multiple that seems to make the most sense for that sector, given how value is measured and created.

CONVENTIONAL USAGE...

Sector	Multiple Used	Rationale
Cyclical Manufacturing	PE, Relative PE	Often with normalized earnings
Growth firms	PEG ratio	Big differences in growth rates
Young growth firms w/ losses	Revenue Multiples	What choice do you have?
Infrastructure	EV/EBITDA	Early losses, big DA
REIT	P/CFE (where CFE = Net income + Depreciation)	Big depreciation charges on real estate
Financial Services	Price/ Book equity	Marked to market?
Retailing	Revenue multiples	Margins equalize sooner or later

A CLOSING THOUGHT...

