



Aswath Damodaran

VALUATION: ART, CRAFT OR MAGIC?

Aswath Damodaran
www.damodaran.com

Some Initial Thoughts

" One hundred thousand lemmings cannot be wrong"

Graffiti

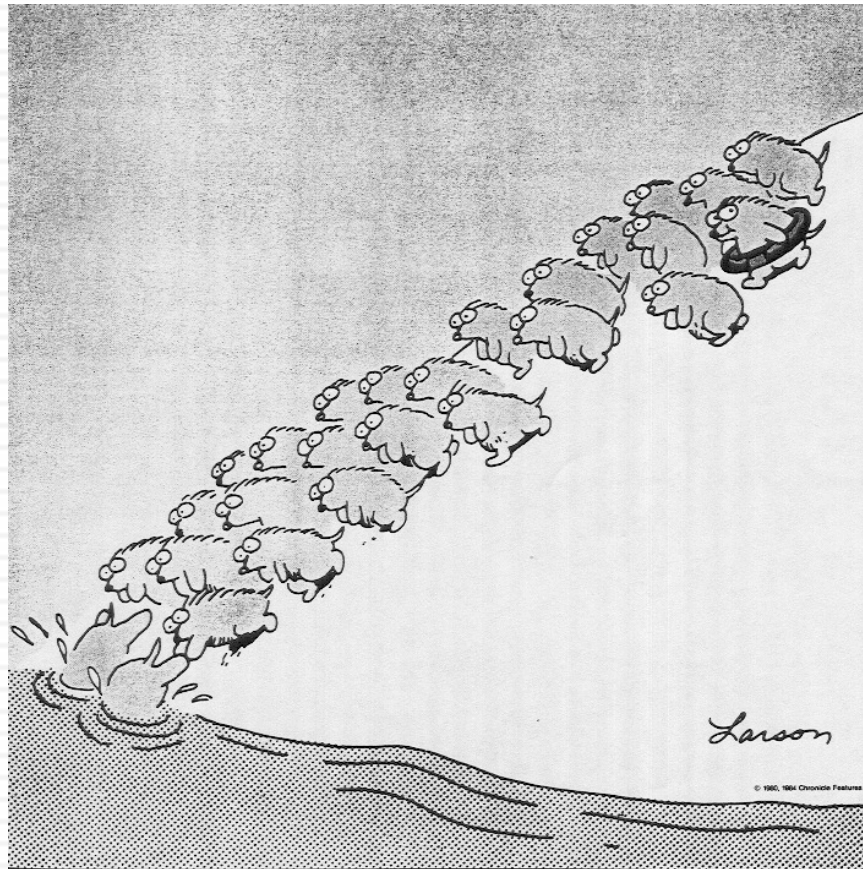

Aswath Damodaran

Misconceptions about Valuation

- Myth 1: A valuation is an objective search for “true” value
 - ▣ Truth 1.1: All valuations are biased. The only questions are how much and in which direction.
 - ▣ Truth 1.2: The direction and magnitude of the bias in your valuation is directly proportional to who pays you and how much you are paid.
- Myth 2.: A good valuation provides a precise estimate of value
 - ▣ Truth 2.1: There are no precise valuations
 - ▣ Truth 2.2: The payoff to valuation is greatest when valuation is least precise.
- Myth 3: . The more quantitative a model, the better the valuation
 - ▣ Truth 3.1: One’s understanding of a valuation model is inversely proportional to the number of inputs required for the model.
 - ▣ Truth 3.2: Simpler valuation models do much better than complex ones.

Approaches to Valuation

- **Intrinsic valuation**, relates the value of an asset to the present value of expected future cashflows on that asset. In its most common form, this takes the form of a discounted cash flow valuation.
- **Relative valuation**, estimates the value of an asset by looking at the pricing of 'comparable' assets relative to a common variable like earnings, cash flows, book value or sales.
- **Contingent claim valuation**, uses option pricing models to measure the value of assets that share option characteristics.

Discounted Cash Flow Valuation

- *What is it:* In discounted cash flow valuation, the value of an asset is the present value of the expected cash flows on the asset.
- *Philosophical Basis:* Every asset has an intrinsic value that can be estimated, based upon its characteristics in terms of cash flows, growth and risk.
- *Information Needed:* To use discounted cash flow valuation, you need
 - to estimate the life of the asset
 - to estimate the cash flows during the life of the asset
 - to estimate the discount rate to apply to these cash flows to get present value
- *Market Inefficiency:* Markets are assumed to make mistakes in pricing assets across time, and are assumed to correct themselves over time, as new information comes out about assets.

Risk Adjusted Value: Three Basic Propositions

- The value of an asset is the present value of the expected cash flows on that asset, over its expected life:

$$\text{Value of asset} = \frac{E(CF_1)}{(1+r)} + \frac{E(CF_2)}{(1+r)^2} + \frac{E(CF_3)}{(1+r)^3} \dots + \frac{E(CF_n)}{(1+r)^n}$$

- Proposition 1: If “it” does not affect the cash flows or alter risk (thus changing discount rates), “it” cannot affect value.
- Proposition 2: For an asset to have value, the expected cash flows have to be positive some time over the life of the asset.
- Proposition 3: Assets that generate cash flows early in their life will be worth more than assets that generate cash flows later; the latter may however have greater growth and higher cash flows to compensate.

DCF Choices: Equity Valuation versus Firm Valuation

Firm Valuation: Value the entire business

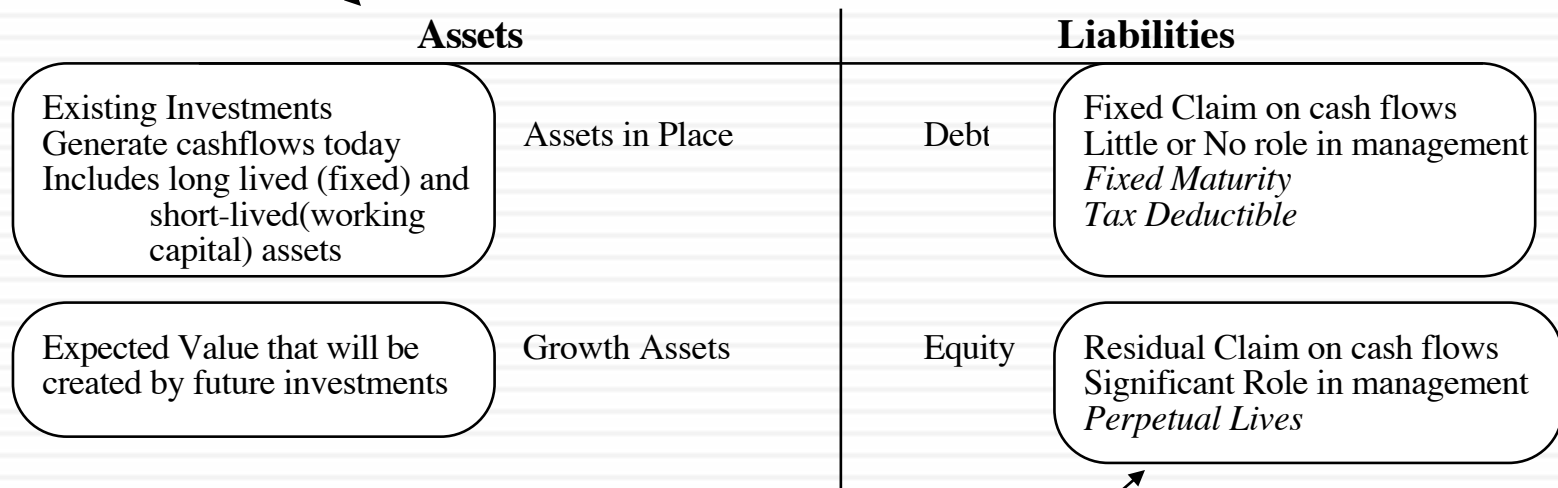

Equity valuation: Value just the equity claim in the business

The Drivers of Value...

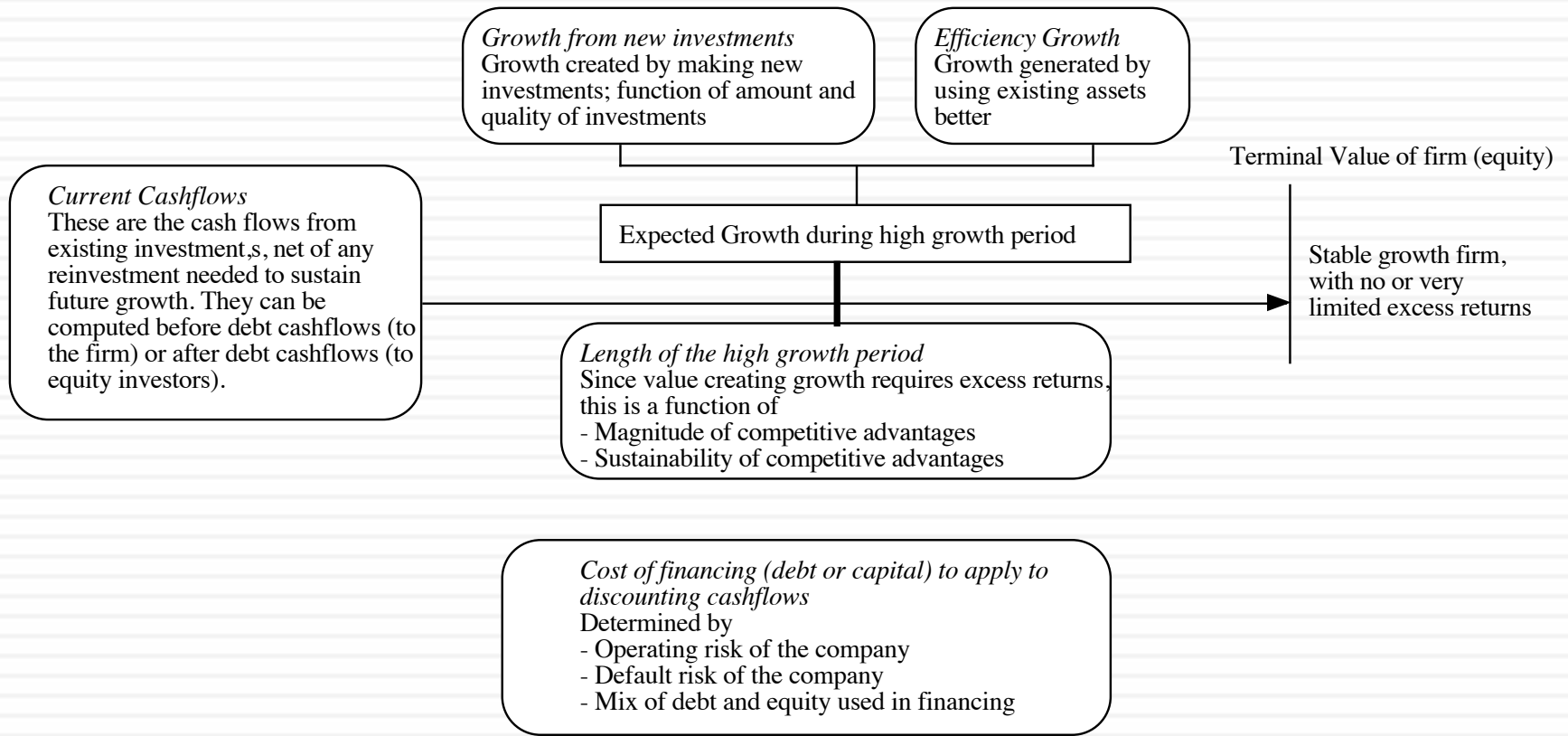

DISCOUNTED CASHFLOW VALUATION

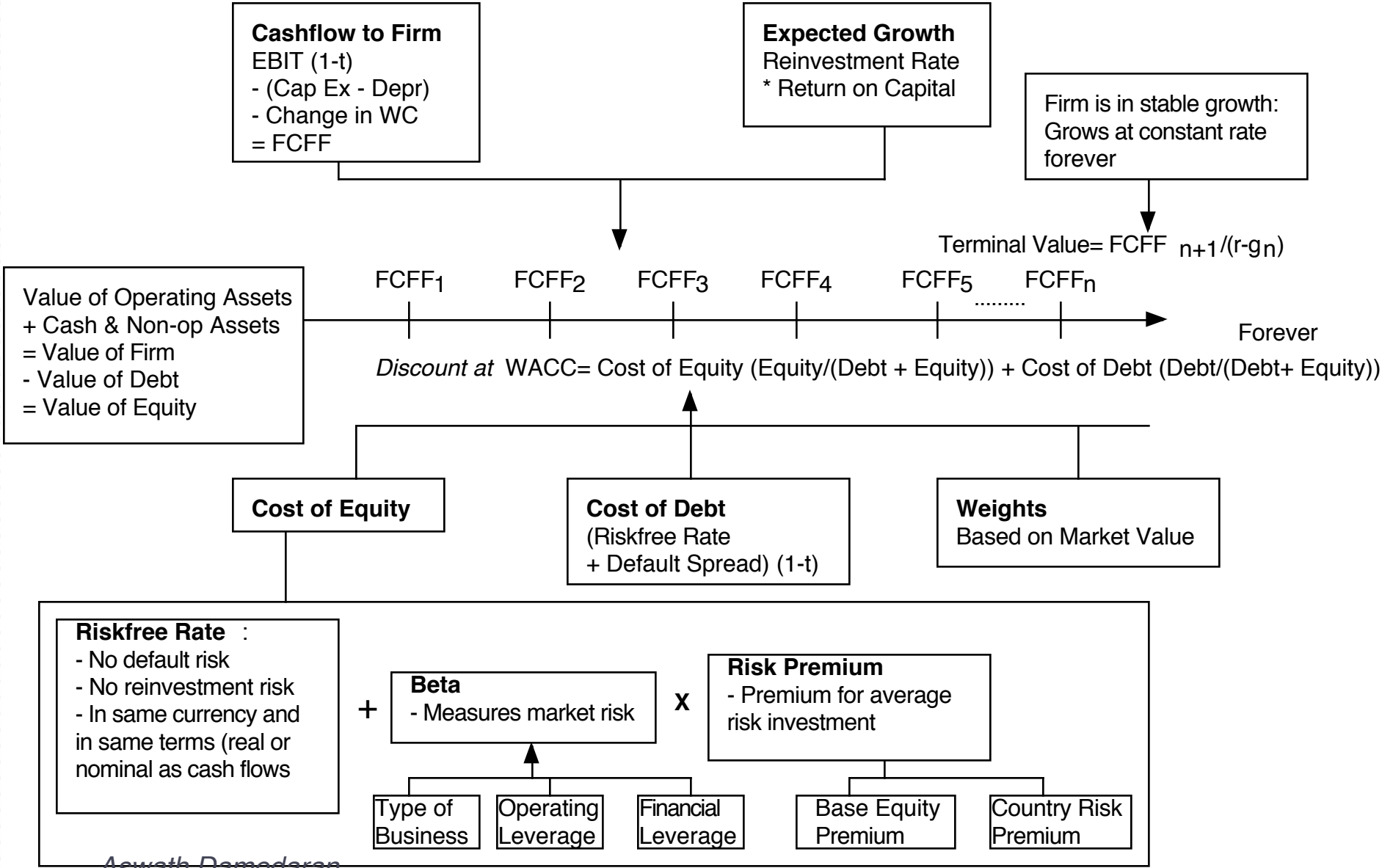

Amgen: Status Quo

Cap Ex = Acc net Cap Ex(255) + Acquisitions (3975) + R&D (2216)

Current Cashflow to Firm

EBIT(1-t) = :7336(1-.28) = 6058
 - Nt CpX = 6443
 - Chg WC 37
 = FCFF - 423
 Reinvestment Rate = 6480/6058 = 106.98%
 Return on capital = 16.71%

Reinvestment Rate 60%

Expected Growth in EBIT (1-t)
 $.60 * .16 = .096$
 9.6%

Return on Capital 16%

Stable Growth

g = 4%; Beta = 1.10;
 Debt Ratio = 20%; Tax rate = 35%
 Cost of capital = 8.08%
 ROC = 10.00%;
 Reinvestment Rate = 4/10 = 40%

Terminal Value₁₀ = 7300 / (.0808 - .04) = 179,099

First 5 years

Growth decreases gradually to 4%

Op. Assets 94214
 + Cash: 1283
 - Debt 8272
 = Equity 87226
 - Options 479
 Value/Share \$ 74.33

Year	1	2	3	4	5	6	7	8	9	10
EBIT	\$9,221	\$10,106	\$11,076	\$12,140	\$13,305	\$14,433	\$15,496	\$16,463	\$17,306	\$17,998
EBIT (1-t)	\$6,639	\$7,276	\$7,975	\$8,741	\$9,580	\$10,392	\$11,157	\$11,853	\$12,460	\$12,958
- Reinvestment	\$3,983	\$4,366	\$4,785	\$5,244	\$5,748	\$5,820	\$5,802	\$5,690	\$5,482	\$5,183
= FCFF	\$2,656	\$2,911	\$3,190	\$3,496	\$3,832	\$4,573	\$5,355	\$6,164	\$6,978	\$7,775

Term Yr
 18718
 12167
 4867
 7300

Cost of Capital (WACC) = 11.7% (0.90) + 3.66% (0.10) = 10.90%

Debt ratio increases to 20%
 Beta decreases to 1.10

Cost of Equity 11.70%

Cost of Debt
 $(4.78\% + .85\%)(1 - .35)$
 = 3.66%

Weights
 E = 90% D = 10%

On May 1, 2007,
 Amgen was trading
 at \$ 55/share

Riskfree Rate:
 Riskfree rate = 4.78%

+

Beta
 1.73

x

Risk Premium
 4%

Unlevered Beta for
 Sectors: 1.59

D/E = 11.06%

Aswath Damodaran

Tata Motors: April 2010

Current Cashflow to Firm

EBIT(1-t) : Rs 20,116
 - Nt CpX Rs 31,590
 - Chg WC Rs 2,732
 = FCFF - Rs 14,205
 Reinv Rate = $(31590+2732)/20116 = 170.61\%$; Tax rate = 21.00%
 Return on capital = 17.16%

Average reinvestment rate
 from 2005-09: 179.59%;
 without acquisitions: 70%

Reinvestment Rate
 70%

Expected Growth
 from new inv.
 $70 \cdot 17.16 = 0.1201$

Return on Capital
 17.16%

Stable Growth
 $g = 5\%$; Beta = 1.00
 Country Premium = 3%
 Cost of capital = 10.39%
 Tax rate = 33.99%
 ROC = 10.39%;
 Reinvestment Rate = $g/ROC = 5/10.39 = 48.11\%$

Rs Cashflows

Year	1	2	3	4	5	6	7	8	9	10
EBIT (1-t)	22533	25240	28272	31668	35472	39236	42848	46192	49150	51607
- Reinvestment	15773	17668	19790	22168	24830	25242	25138	24482	23264	21503
FCFF	6760	7572	8482	9500	10642	13994	17711	21710	25886	30104

Terminal Value₅ = $23493 / (.1039 - .05) = \text{Rs } 435,686$

45278
 21785
 23493

Op. Assets Rs 210,813
 + Cash: 11418
 + Other NO 140576
 - Debt 109198
 = Equity 253,628

Value/Share Rs 614

Discount at Cost of Capital (WACC) = $14.00\% (.747) + 8.09\% (0.253) = 12.50\%$

Growth declines to 5%
 and cost of capital
 moves to stable period
 level.

Cost of Equity
 14.00%

Cost of Debt
 $(5\% + 4.25\% + 3\%)(1 - .3399)$
 = 8.09%

Weights
 E = 74.7% D = 25.3%

On April 1, 2010
 Tata Motors price = Rs 781

Riskfree Rate:
 Rs Riskfree Rate = 5%

+

Beta
 1.20

X

Mature market
 premium
 4.5%

+

Lambda
 0.80

X

Country Equity Risk
 Premium
 4.50%

Aswath Damodaran

Unlevered Beta for
 Sectors: 1.04

Firm's D/E
 Ratio: 33%

Country Default
 Spread
 3%

X

Rel Equity
 Mkt Vol
 1.50

Indofoods - April 2014

Average annual values from 2009-2013

Current Cashflow to Firm
 EBIT(1-t) = 6,222(1-.263) = 4,587
 - (Cap Ex - Deprecn) 4,997
 - Chg Working capital 63
 = FCFF -473
 Reinvestment Rate = 7,967/4587
 =175.04%
 Return on capital = 21.15%

Reinvestment Rate
78.03%

Return on Capital
22.20%

Expected Growth
 $.222 * .7803 = .1725$ or 17.25%

Stable Growth
 g = 6%; Beta = 1.00;
 Debt % = 30.3%; k(debt) = 7.5%
 Cost of capital = 12.2%
 Tax rate = 25%; ROC = 15%;
 Reinvestment Rate = 6/15 = 40%

Terminal Value₁₀ = 10,810 / (.122 - .06) = 174,434

First 5 years

Growth declines gradually to 2.75%

Op. Assets 71,223
 + Cash: 18,367
 - Debt 27,492
 - Minority Int 14,725
 = Equity 47,373
 - Options 0
Value/Share 5,395 IDR

Year	1	2	3	4	5	6	7	8	9	10
EBIT (1-t)	5388	6328	7432	8729	10252	11809	13338	14763	16008	16997
- Reinvestment	4204	4938	5799	6811	7999	8317	8378	8151	7621	6799
FCFF	1184	1390	1633	1918	2252	3493	4959	6612	8387	10198

Term Yr
 18,017
 7,207
 10,810

Cost of Capital (WACC) = 14.20% (0.697) + 9.56% (0.303) = 12.79%

Cost of capital declines gradually to 12.2%

Cost of Equity 14.20

Cost of Debt
 (6.24% + 4.3% + 2.2%) (1 - .25)
 = 9.56%
 Based on actual A rating

Weights
 E = 69.7% D = 30.3%

In April 2014, Indofoods was trading at 7200 IDR/share

Riskfree Rate:
 Riskfree rate = 6.24%

Beta
 0.97

ERP for operations
 8.21%

Unlevered Beta for Sectors: 0.7323

D/E = 43.49%

Indonesia	92.70%	8.30%
Other countries	7.30%	Varied
Indofood	100.00%	8.21%

Aswath Damodaran



DCF INPUTS

“Garbage in, garbage out”

I. Measure earnings right..

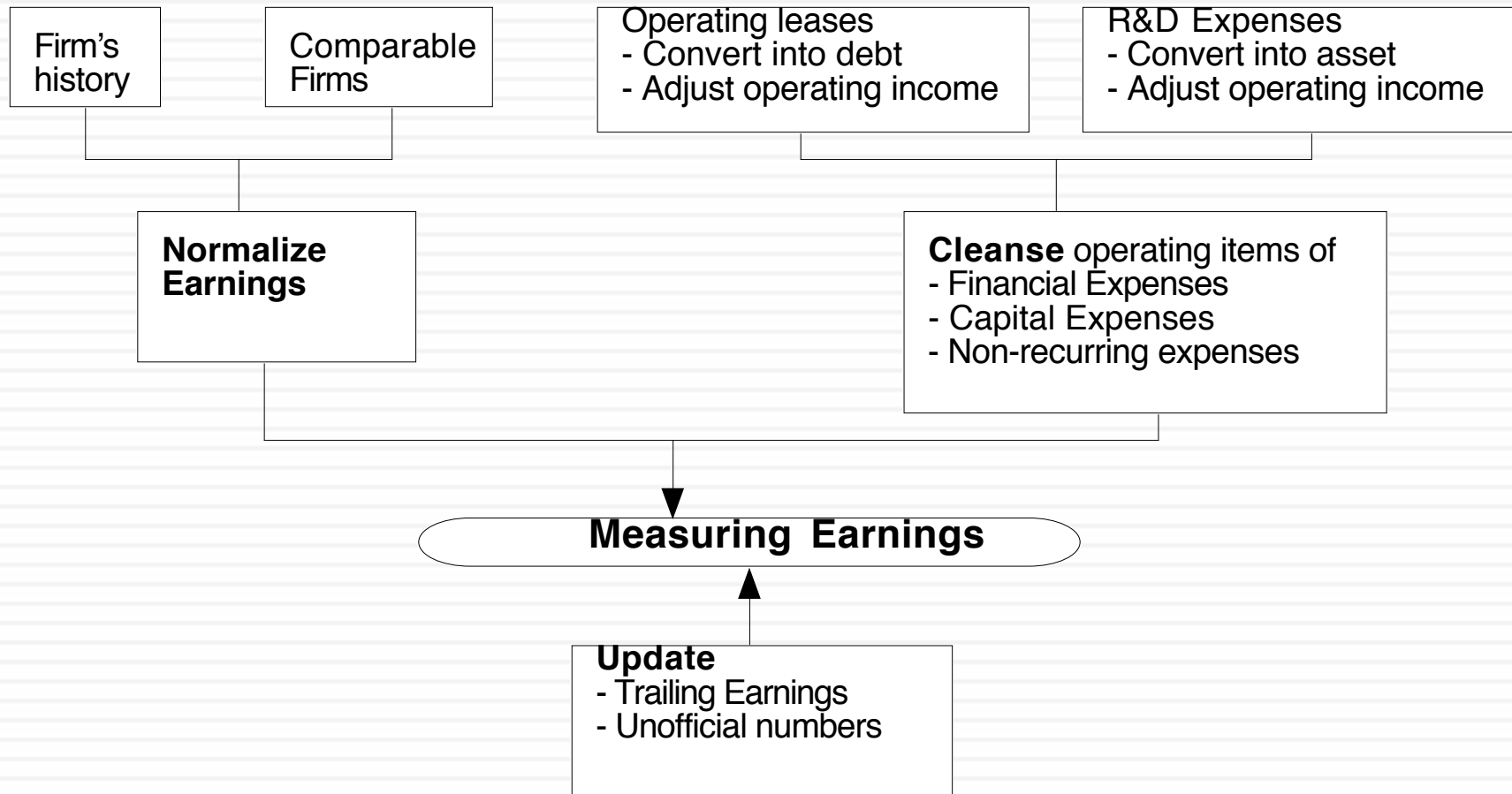

Operating Leases at Amgen in 2007

- Amgen has lease commitments and its cost of debt (based on its A rating) is 5.63%.

Year	Commitment	Present Value
1	\$96.00	\$90.88
2	\$95.00	\$85.14
3	\$102.00	\$86.54
4	\$98.00	\$78.72
5	\$87.00	\$66.16
6-12	\$107.43	\$462.10 (\$752 million prorated)

- Debt Value of leases = \$869.55
- Debt outstanding at Amgen = \$7,402 + \$ 870 = \$8,272 million
- Adjusted Operating Income = Stated OI + Lease expense this year – Depreciation
= 5,071 m + 69 m - 870/12 = \$5,068 million (12 year life for assets)
- Approximate Operating income= stated OI + PV of Lease commitment * Pre-tax cost of debt
= \$5,071 m + 870 m (.0563) = \$ 5,120 million

Capitalizing R&D Expenses: Amgen

- R & D was assumed to have a 10-year life.

Year	R&D Expense	Unamortized portion	Amortization this year	
Current	3366.00	1.00	3366.00	
-1	2314.00	0.90	2082.60	\$231.40
-2	2028.00	0.80	1622.40	\$202.80
-3	1655.00	0.70	1158.50	\$165.50
-4	1117.00	0.60	670.20	\$111.70
-5	865.00	0.50	432.50	\$86.50
-6	845.00	0.40	338.00	\$84.50
-7	823.00	0.30	246.90	\$82.30
-8	663.00	0.20	132.60	\$66.30
-9	631.00	0.10	63.10	\$63.10
-10	558.00	0.00	0.00	\$55.80
Value of Research Asset =			\$10,112.80	\$1,149.90

- Adjusted Operating Income = \$5,120 + 3,366 - 1,150 = \$7,336 million

II. Get the big picture (not the accounting one) when it comes to cap ex and working capital

- Capital expenditures should include
 - ▣ Research and development expenses, once they have been re-categorized as capital expenses.
 - ▣ Acquisitions of other firms, whether paid for with cash or stock.
- Working capital should be defined not as the difference between current assets and current liabilities but as the difference between non-cash current assets and non-debt current liabilities.
- On both items, start with what the company did in the most recent year but do look at the company's history and at industry averages.

Amgen's Net Capital Expenditures

- The accounting net cap ex at Amgen is small:
 - ▣ Accounting Capital Expenditures = \$1,218 million
 - ▣ - Accounting Depreciation = \$ 963 million
 - ▣ Accounting Net Cap Ex = \$ 255 million
- We define capital expenditures broadly to include R&D and acquisitions:
 - ▣ Accounting Net Cap Ex = \$ 255 million
 - ▣ Net R&D Cap Ex = (3366-1150) = \$2,216 million
 - ▣ Acquisitions in 2006 = \$3,975 million
 - ▣ Total Net Capital Expenditures = \$ 6,443 million
- Acquisitions have been a volatile item. Amgen was quiet on the acquisition front in 2004 and 2005 and had a significant acquisition in 2003.

III. The government bond rate is not always the risk free rate

- When valuing Amgen in US dollars, the US\$ ten-year bond rate of 4.78% was used as the risk free rate. We assumed that the US treasury was default free.
- When valuing Tata Motors in Indian rupees in 2010, the Indian government bond rate of 8% was not default free. Using the Indian government's local currency rating of Ba2 yielded a default spread of 3% for India and a riskfree rate of 5% in Indian rupees.

Risk free rate in Indian Rupees = 8% - 3% = 5%

- To estimate a risk free rate in Indonesian Rupiah for Indofoods, we started with the Indonesian government bond rate in rupiah of 8.44% and subtracted out a default risk spread for Indonesia (estimated at 2.20% based on its ratings of Baa3 and at 2.44% in the CDS market):
 - Risk free rate in Indonesian Rupiah (based on rating) = 8.44% - 2.20% = 6.24%
 - Risk free rate in Indonesian Rupiah (based on CDS) = 8.44% - 2.44% = 6.00%

Risk free rates will vary across currencies!

Riskfree Rates: January 2015

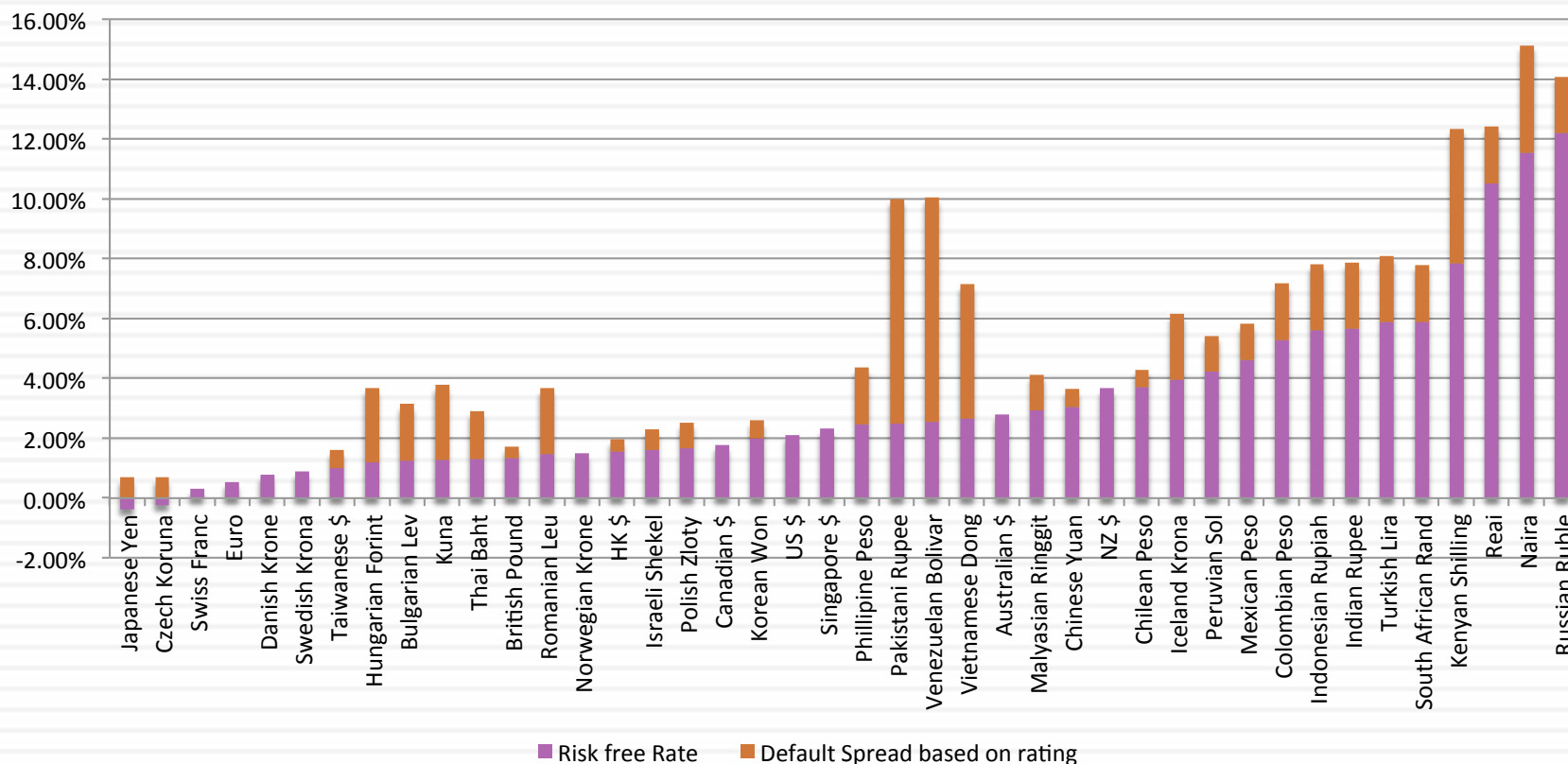

But valuations should not!

	In Indian Rupees	In US \$
Risk free Rate	5.00%	2.00%
Expected inflation rate	4.00%	1.00%
Cost of capital		
- High Growth	12.50%	9.25%
- Stable Growth	10.39%	7.21%
Expected growth rate		
- High Growth	12.01%	8.78%
- Stable Growth	5.00%	2.00%
Return on Capital		
- High Growth	17.16%	13.78%
- Stable Growth	10.39%	7.21%
Value per share	Rs 614	\$12.79/share (roughly Rs 614 at current exchange rate)

IV. Betas do not come from regressions... and are noisy...

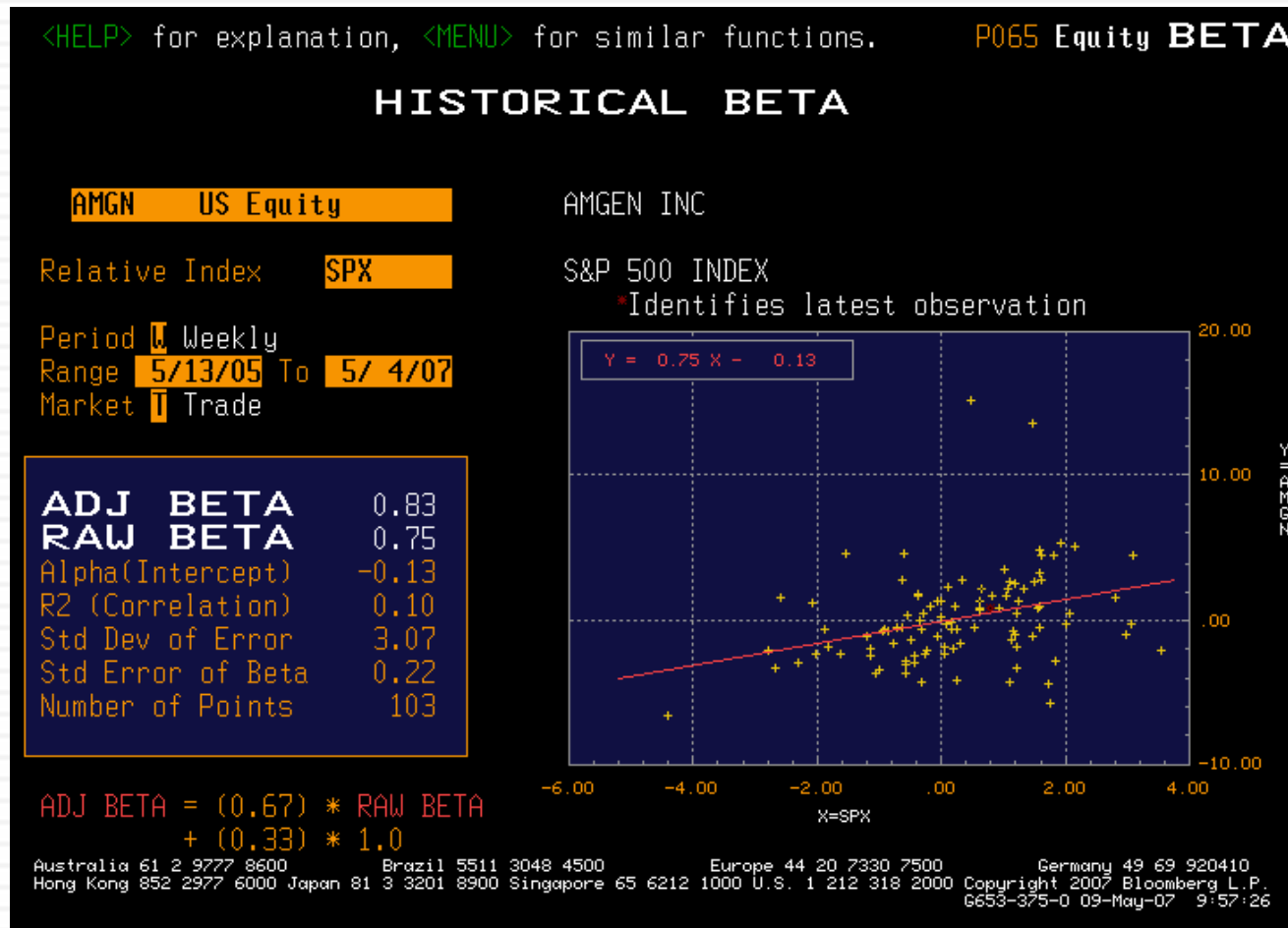

Look better for some companies, but not if run against narrow indices

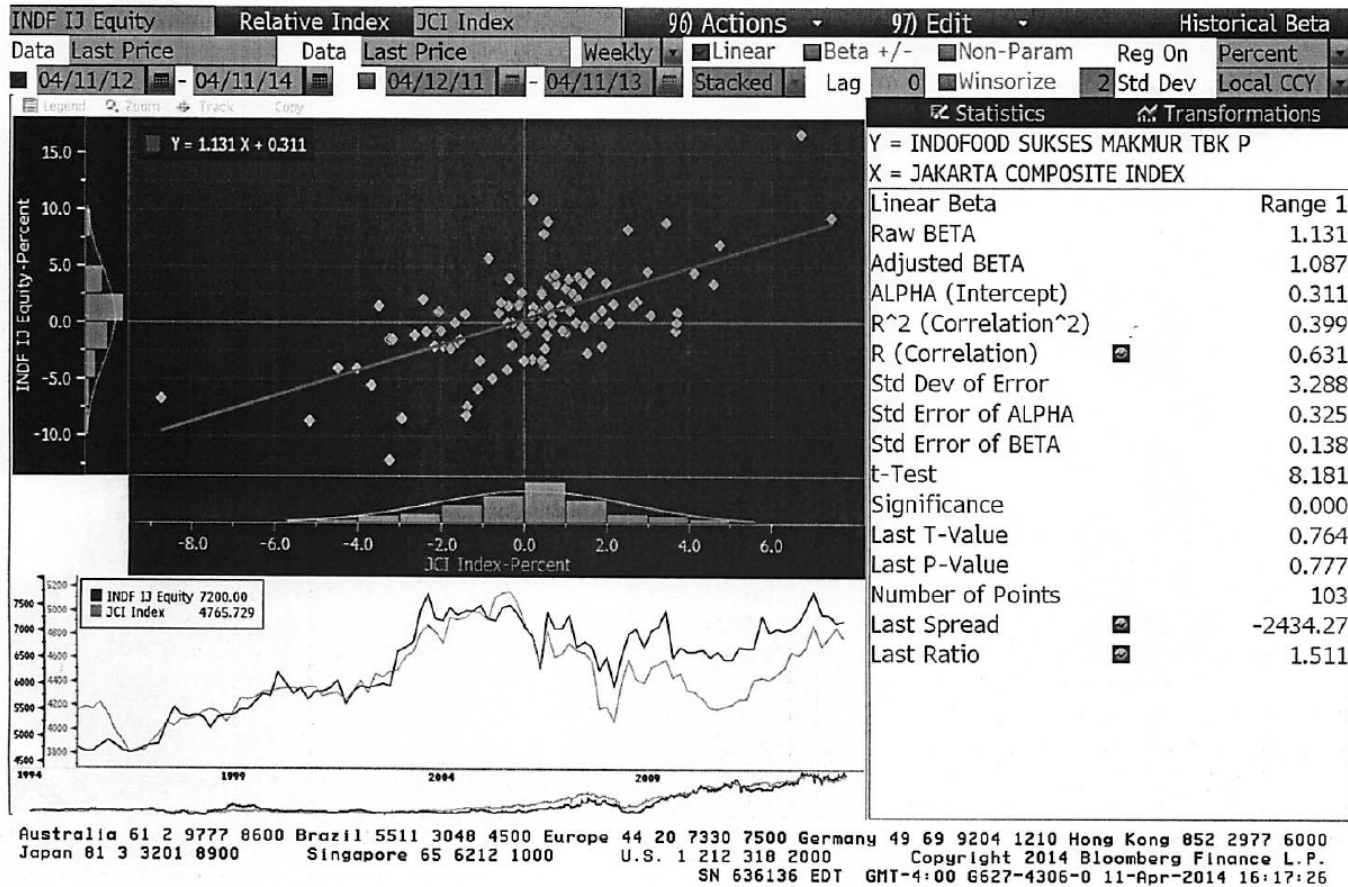

Determinants of Betas

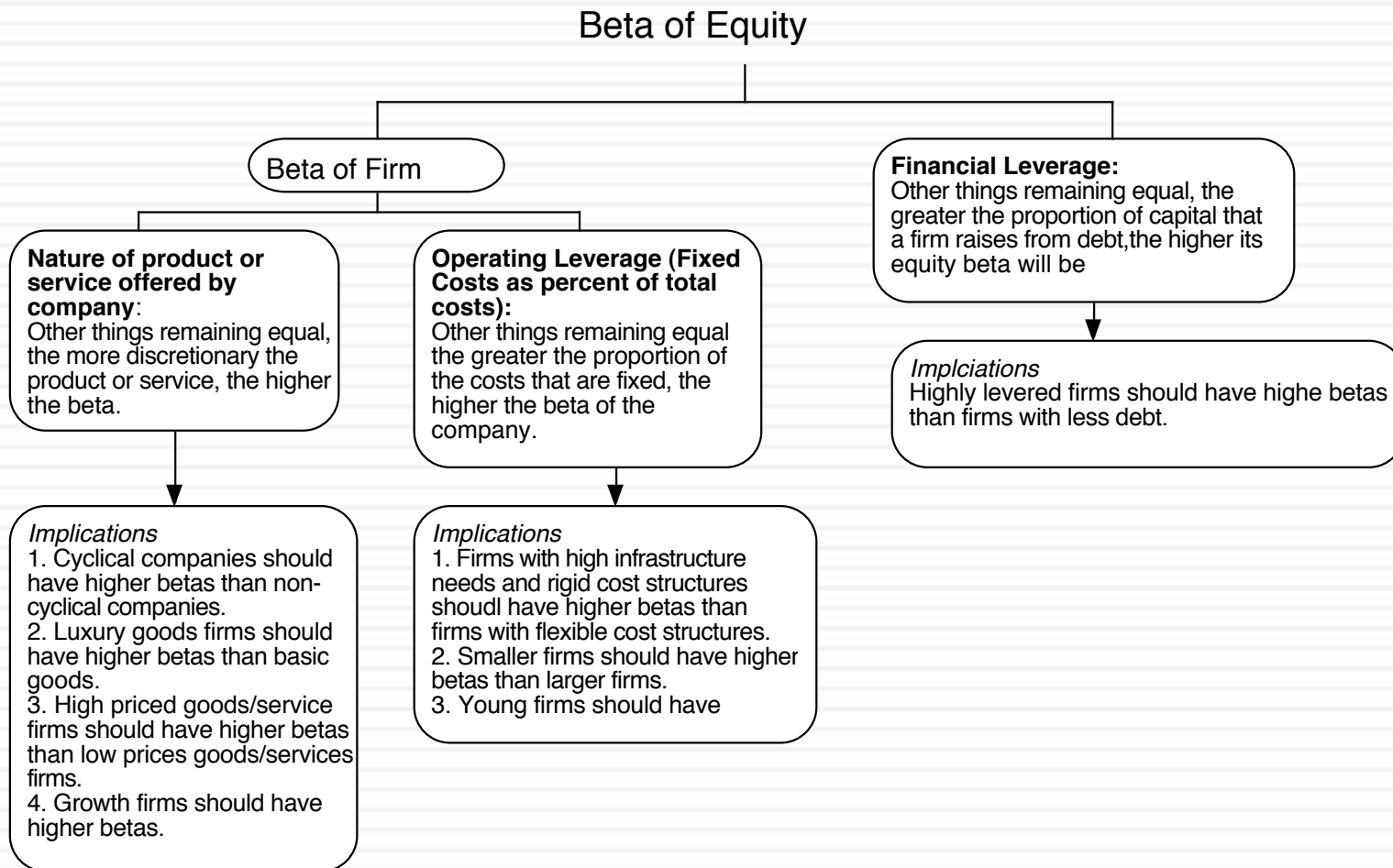

Bottom-up Betas

Step 1: Find the business or businesses that your firm operates in.

Step 2: Find publicly traded firms in each of these businesses and obtain their regression betas. Compute the simple average across these regression betas to arrive at an average beta for these publicly traded firms. Unlever this average beta using the average debt to equity ratio across the publicly traded firms in the sample.
Unlevered beta for business = Average beta across publicly traded firms / $(1 + (1-t) (\text{Average D/E ratio across firms}))$

Step 3: Estimate how much value your firm derives from each of the different businesses it is in.

Step 4: Compute a weighted average of the unlevered betas of the different businesses (from step 2) using the weights from step 3.
Bottom-up Unlevered beta for your firm = Weighted average of the unlevered betas of the individual business

Step 5: Compute a levered beta (equity beta) for your firm, using the market debt to equity ratio for your firm.
Levered bottom-up beta = Unlevered beta $(1 + (1-t) (\text{Debt/Equity}))$

Possible Refinements

If you can, adjust this beta for differences between your firm and the comparable firms on operating leverage and product characteristics.

While revenues or operating income are often used as weights, it is better to try to estimate the value of each business.

If you expect the business mix of your firm to change over time, you can change the weights on a year-to-year basis.

If you expect your debt to equity ratio to change over time, the levered beta will change over time.

Three examples...

□ Amgen

- The unlevered beta for pharmaceutical firms is 1.59. Using Amgen's debt to equity ratio of 11%, the bottom up beta for Amgen is
- Bottom-up Beta = $1.59 (1 + (1 - .35)(.11)) = 1.73$

□ Tata Motors

- The unlevered beta for automobile firms is 0.98. Using Tata Motor's debt to equity ratio of 33.87%, the bottom up beta for Tata Motors is
- Bottom-up Beta = $0.98 (1 + (1 - .3399)(.3387)) = 1.20$

A multi-business company

- Indofoods is in three businesses – agribusiness, food processing and food distribution:

<i>Business</i>	<i>Revenues</i>	<i>EV/Sales</i>	<i>Estimated Value</i>	<i>% of company</i>	<i>Unlevered Beta</i>
Food Processing	\$68.00	1.3988	\$95.12	83.02%	0.7606
Agribusiness	\$24.00	0.6300	\$15.12	13.20%	0.5700
Retail/Wholesale Food	\$8.00	0.5414	\$4.33	3.78%	0.6770
Indofoods	\$100.00		\$114.57		0.7323

- To get the levered beta for the operating assets of the company, we use Indofood's market D/E ratio of 43.49%:

<i>Business</i>	<i>Unlevered Beta</i>	<i>D/E ratio</i>	<i>Levered Beta</i>
Food Processing	0.7606	43.49%	1.01
Agribusiness	0.5700	43.49%	0.76
Retail/Wholesale Food	0.6770	43.49%	0.90
Indofoods	0.7323	43.49%	0.97

V. And the past is not always a good indicator of the future

	Arithmetic Average		Geometric Average	
	Stocks - T. Bills	Stocks - T. Bonds	Stocks - T. Bills	Stocks - T. Bonds
1928-2014	8.00%	6.25%	6.11%	4.60%
	2.17%	2.32%		
1965-2014	6.19%	4.12%	4.84%	3.14%
	2.42%	2.74%		
2005-2014	7.94%	4.06%	6.18%	2.73%
	6.05%	8.65%		

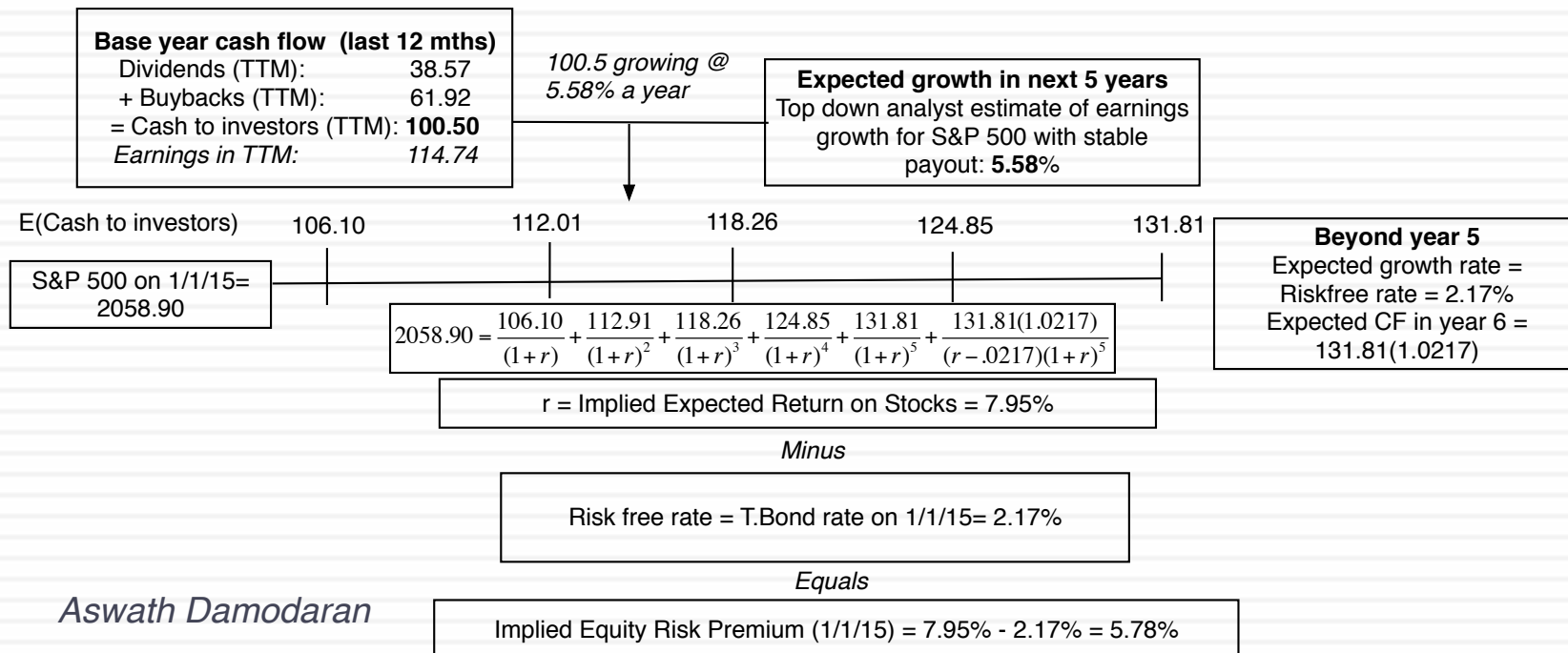

Implied Premiums in the US: 1960-2014

Implied Premium for US Equity Market: 1960-2014

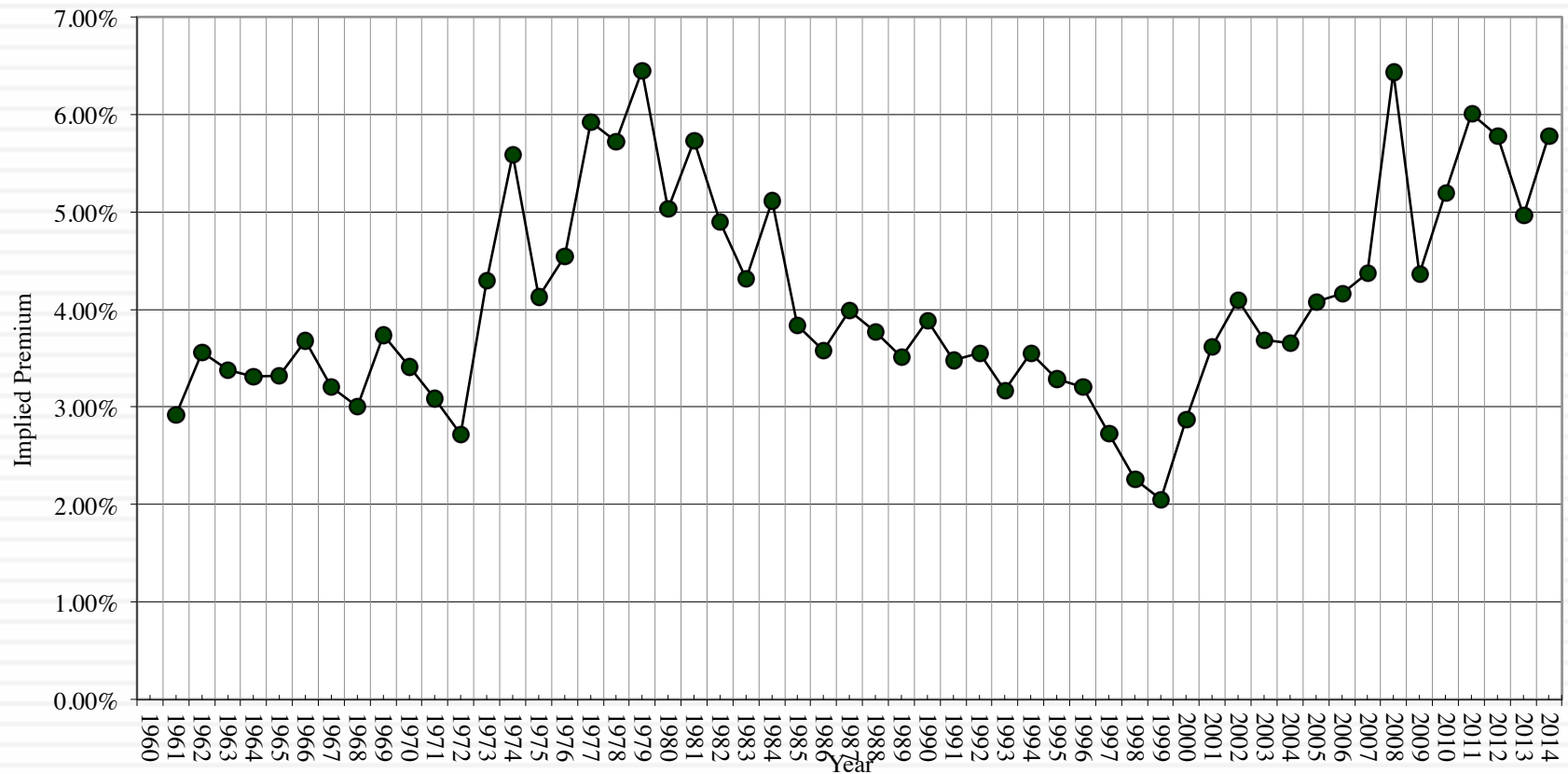

The Anatomy of a Crisis: Implied ERP from September 12, 2008 to January 1, 2009

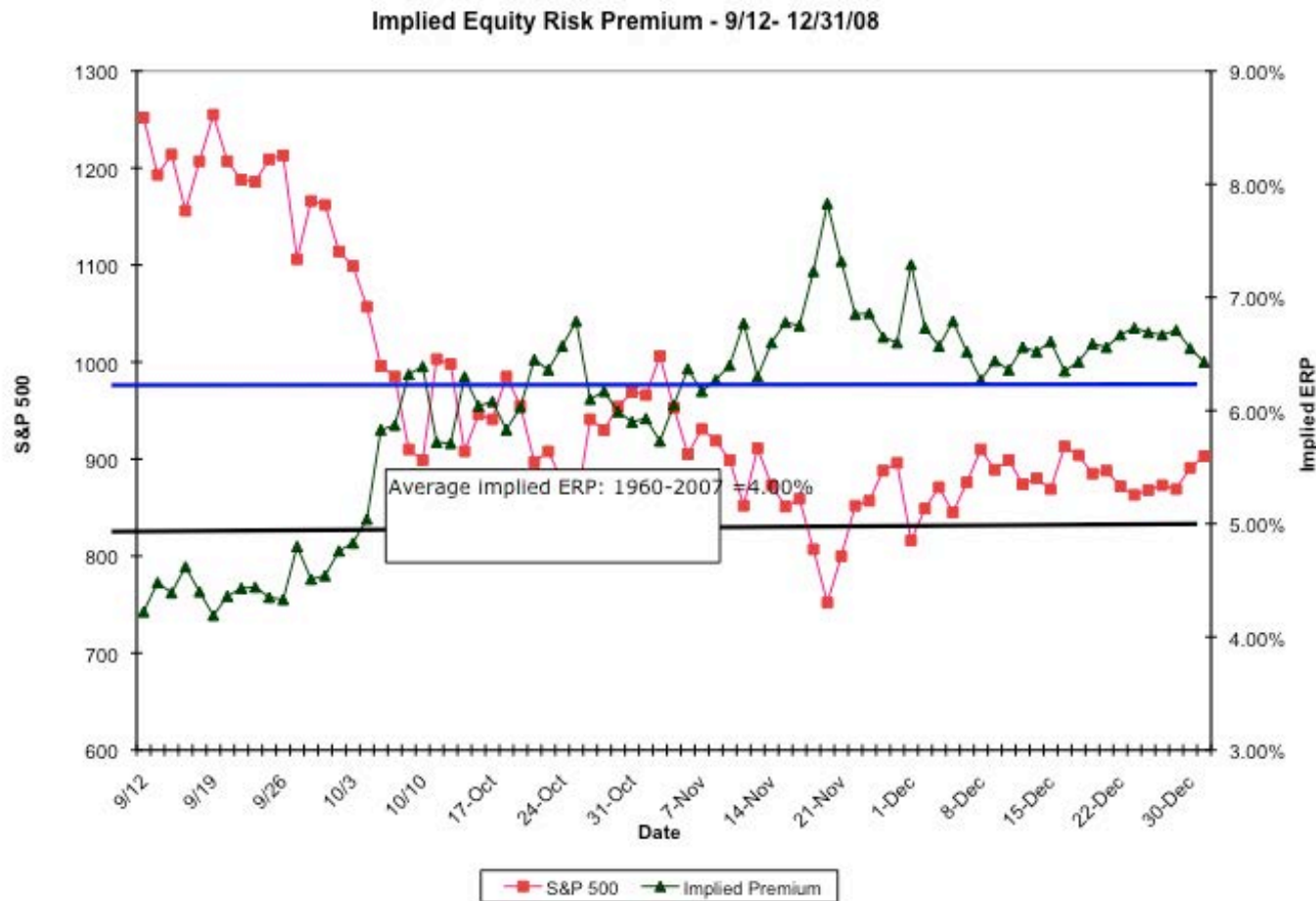

Implied Premium for India using the Sensex: April 2010

- Level of the Index = 17559
- FCFE on the Index = 3.5% (Estimated FCFE for companies in index as % of market value of equity)
- Other parameters
 - Riskfree Rate = 5% (Rupee)
 - Expected Growth (in Rupee)
 - Next 5 years = 20% (Used expected growth rate in Earnings)
 - After year 5 = 5%
- Solving for the expected return:
 - Expected return on Equity = 11.72%
 - Implied Equity premium for India = $11.72\% - 5\% = 6.72\%$

Emerging versus Developed Markets: Implied Equity Risk Premiums

$$PBV = \frac{(\text{Return on equity} - \text{Expected growth rate})}{(\text{Cost of equity} - \text{Expected growth rate})}$$

$$\text{Cost of Equity} = \frac{(\text{ROE} - \text{Expected growth rate})}{PBV} + \text{Expected growth rate}$$

	<i>PBV- Developed</i>	<i>PBV - Emerging</i>	<i>ROE - Developed</i>	<i>ROE- Emerging</i>	<i>T.Bond rate</i>	<i>Cost of equity (Developed)</i>	<i>Cost of equity (Emerging)</i>	<i>Differential</i>
2004	2.00	1.19	10.81%	11.65%	4.22%	7.52%	10.46%	2.95%
2005	2.09	1.27	11.12%	11.93%	4.39%	7.61%	10.33%	2.72%
2006	2.03	1.44	11.32%	12.18%	4.70%	7.96%	9.89%	1.93%
2007	1.67	1.67	10.87%	12.88%	4.02%	8.12%	9.33%	1.20%
2008	0.87	0.83	9.42%	11.12%	2.21%	10.50%	12.94%	2.45%
2009	1.20	1.34	8.48%	11.02%	3.84%	7.71%	9.20%	1.49%
2010	1.39	1.43	9.14%	11.22%	3.29%	7.50%	8.84%	1.34%
2011	1.12	1.08	9.21%	10.04%	1.88%	8.42%	9.44%	1.01%
2012	1.17	1.18	9.10%	9.33%	1.76%	8.03%	8.18%	0.14%
Jun-13	1.17	1.17	8.79%	9.37%	2.55%	7.88%	8.38%	0.50%

VI. There is a downside to globalization...

- Emerging markets offer growth opportunities but they are also riskier. If we want to count the growth, we have to also consider the risk.
- Two ways of estimating the country risk premium:
 - Sovereign Default Spread: In this approach, the country equity risk premium is set equal to the default spread of the bond issued by the country.
 - Equity Risk Premium for mature market = 4.50%
 - Default Spread for India = 3.00% (based on rating)
 - Equity Risk Premium for India = 4.50% + 3.00%
 - Adjusted for equity risk: The country equity risk premium is based upon the volatility of the equity market relative to the government bond rate.
 - Country risk premium = $\text{Default Spread} \times \frac{\text{Std Deviation}_{\text{Country Equity}}}{\text{Std Deviation}_{\text{Country Bond}}}$
 - Standard Deviation in Sensex = 21%
 - Standard Deviation in Indian government bond = 14%
 - Default spread on Indian Bond = 2%
 - Additional country risk premium for India = $2\% \times (21/14) = 3\%$
 - Total equity risk premium = US equity risk premium + CRP for India = 6% + 3% = 9%

Indonesia's Country Risk Premium

- Default Spread for Indonesia in April 2014
 - ▣ CDS Spread for Indonesia in April 2014 = 2.54%
 - ▣ Spread based upon Indonesia's Baa3 rating = 2.20%
- Relative Volatility
 - ▣ Standard deviation in Indonesian equities = 16.94%
 - ▣ Standard deviation in Indonesian Government Bond = 10.73%
 - ▣ Relative standard deviation = $16.94\%/10.73\% = 1.58$ (approximately)
 - ▣ Country risk premium for Indonesia = $2.20\% (1.58) = 3.48\%$
 - ▣ If you use the average relative volatility measure across all emerging markets (about 1.50), country risk premium = $2.20\% (1.50) = 3.30\%$
- Estimating equity risk premium for Indonesia
 - ▣ Mature market premium on April 1, 2014 = 5.00% (US S&P 500)
 - ▣ Country risk premium for Indonesia = 3.30%
 - ▣ Total Equity risk premium for Indonesia = $5.00\% + 3.30\% = 8.30\%$

ERP : Jan 2015

Andorra	8.15%	2.40%	Italy	8.60%	2.85%
Austria	5.75%	0.00%	Jersey	6.35%	0.60%
Belgium	6.65%	0.90%	Liechtenstein	5.75%	0.00%
Cyprus	15.50%	9.75%	Luxembourg	5.75%	0.00%
Denmark	5.75%	0.00%	Malta	7.55%	1.80%
Finland	5.75%	0.00%	Netherlands	5.75%	0.00%
France	6.35%	0.60%	Norway	5.75%	0.00%
Germany	5.75%	0.00%	Portugal	9.50%	3.75%
Greece	17.00%	11.25%	Spain	8.60%	2.85%
Guernsey	6.35%	0.60%	Sweden	5.75%	0.00%
Iceland	9.05%	3.30%	Switzerland	5.75%	0.00%
Ireland	8.15%	2.40%	Turkey	9.05%	3.30%
Isle of Man	6.35%	0.60%	UK	6.35%	0.60%
			W. Europe	6.88%	1.13%

Albania	12.50%	6.75%	Montenegro	11.15%	5.40%
Armenia	10.25%	4.50%	Poland	7.03%	1.28%
Azerbaijan	9.05%	3.30%	Romania	9.05%	3.30%
Belarus	15.50%	9.75%	Russia	8.60%	2.85%
Bosnia	15.50%	.75%	Serbia	12.50%	6.75%
Bulgaria	8.60%	2.85%	Slovakia	7.03%	1.28%
Croatia	9.50%	3.75%	Slovenia	9.50%	3.75%
Czech Repub	6.80%	1.05%	Ukraine	20.75%	15.00%
Estonia	6.80%	1.05%	E. Europe	9.08%	3.33%

Canada	5.75%	0.00%
US	5.75%	0.00%
North America	5.75%	0.00%

Angola	10.25%	4.50%
Botswana	7.03%	1.28%
Burkina Faso	15.50%	9.75%
Cameroon	14.00%	8.25%
Cape Verde	14.00%	8.25%
Congo (DR)	15.50%	9.75%
Congo (Republic)	11.15%	5.40%
Côte d'Ivoire	12.50%	6.75%
Egypt	17.00%	11.25%
Ethiopia	12.50%	6.75%
Gabon	11.15%	5.40%
Ghana	14.00%	8.25%
Kenya	12.50%	6.75%
Morocco	9.50%	3.75%
Mozambique	12.50%	6.75%
Namibia	9.05%	3.30%
Nigeria	11.15%	5.40%
Rwanda	14.00%	8.25%
Senegal	12.50%	6.75%
South Africa	8.60%	2.85%
Tunisia	11.15%	5.40%
Uganda	12.50%	6.75%
Zambia	12.50%	6.75%
Africa	11.73%	5.98%

Georgia	11.15%	5.40%
Hungary	9.50%	3.75%
Kazakhstan	8.60%	2.85%
Latvia	8.15%	2.40%
Lithuania	8.15%	2.40%
Macedonia	11.15%	5.40%
Moldova	15.50%	9.75%

Abu Dhabi	6.50%	0.75%
Bahrain	8.60%	2.85%
Israel	6.80%	1.05%
Jordan	12.50%	6.75%
Kuwait	6.50%	0.75%
Lebanon	14.00%	8.25%
Oman	6.80%	1.05%
Qatar	6.50%	0.75%
Ras Al Khaimah	7.03%	1.28%
Saudi Arabia	6.65%	0.90%
Sharjah	7.55%	1.80%
UAE	6.50%	0.75%
Middle East	6.85%	1.10%

Bangladesh	11.15%	5.40%
Cambodia	14.00%	8.25%
China	6.65%	0.90%
Fiji	12.50%	6.75%
Hong Kong	6.35%	0.60%
India	9.05%	3.30%
Indonesia	9.05%	3.30%
Japan	6.80%	1.05%
Korea	6.65%	0.90%
Macao	6.50%	0.75%
Malaysia	7.55%	1.80%
Mauritius	8.15%	2.40%
Mongolia	14.00%	8.25%
Pakistan	17.00%	11.25%
Papua New Guinea	12.50%	6.75%
Philippines	8.60%	2.85%
Singapore	5.75%	0.00%
Sri Lanka	12.50%	6.75%
Taiwan	6.65%	0.90%
Thailand	8.15%	2.40%
Vietnam	12.50%	6.75%
Asia	7.26%	1.51%

Argentina	17.00%	11.25%
Belize	19.25%	13.50%
Bolivia	11.15%	5.40%
Brazil	8.60%	2.85%
Chile	6.65%	0.90%
Colombia	8.60%	2.85%
Costa Rica	9.50%	3.75%
Ecuador	15.50%	9.75%
El Salvador	11.15%	5.40%
Guatemala	9.50%	3.75%
Honduras	15.50%	9.75%
Mexico	7.55%	1.80%
Nicaragua	15.50%	9.75%
Panama	8.60%	2.85%
Paraguay	10.25%	4.50%
Peru	7.55%	1.80%
Suriname	11.15%	5.40%
Uruguay	8.60%	2.85%
Venezuela	17.00%	11.25%
Latin America	9.95%	4.20%

Black #: Total ERP
 Red #: Country risk premium
 AVG: GDP weighted average

Australia	5.75%	0.00%
Cook Islands	12.50%	6.75%
New Zealand	5.75%	0.00%
Australia & NZ	5.75%	0.00%

Indonesia country risk over time



VII. And it is not just emerging market companies that are exposed to this risk..

- The “default” approach in valuation has been to assign country risk based upon your country of incorporation. Thus, if you are incorporated in a developed market, the assumption has been that you are not exposed to emerging market risks. If you are incorporated in an emerging market, you are saddled with the entire country risk.
- As companies globalize and look for revenues in foreign markets, this practice will under estimate the costs of equity of developed market companies with significant emerging market risk exposure and over estimate the costs of equity of emerging market companies with significant developed market risk exposure.

One way of dealing with this: Operation-based ERP for Indofoods

<i>Country</i>	<i>Revenues</i>	<i>ERP</i>	<i>Weight</i>	<i>Weighted ERP</i>
Indonesia	44650	8.30%	92.73%	7.70%
Saudi Arabia	621	5.90%	1.29%	0.08%
Netherlands	593	5.00%	1.23%	0.06%
Korea	498	5.90%	1.03%	0.06%
China	391	5.90%	0.81%	0.05%
Nigeria	335	10.40%	0.70%	0.07%
Philippines	303	8.30%	0.63%	0.05%
Vietnam	300	13.25%	0.62%	0.08%
Malaysia	263	6.80%	0.55%	0.04%
Singapore	199	5.00%	0.41%	0.02%
Total	48153		100.00%	8.21%

An alternate way: Estimating a company's exposure to country risk (Lambda)

- **Just as beta measures exposure to macro economic risk, lambda measures exposure just to country risk. Like beta, it is scaled around one.**
- The easiest and most accessible data is on revenues. Most companies break their revenues down by region. One simplistic solution would be to do the following:

$$\text{Lambda} = \frac{\% \text{ of revenues domestically}_{\text{firm}}}{\% \text{ of revenues domestically}_{\text{average firm}}}$$

- In 2008-09, Tata Motors got about 91.37% of its revenues in India and TCS got 7.62%. The average Indian firm gets about 80% of its revenues in India:
 - ▣ $\text{Lambda}_{\text{Tata Motors}} = 91\%/80\% = 1.14$
 - ▣ The danger of focusing just on revenues is that it misses other exposures to risk (production and operations).

	<i>Tata Motors</i>	<i>TCS</i>
% of production/operations in India	High	High
% of revenues in India	91.37% (in 2009) Estimated 70% (in 2010)	7.62%
Lambda	0.80	0.20
Flexibility in moving operations	Low. Significant physical assets.	High. Human capital is mobile.

VIII. Growth has to be earned (not endowed or estimated)

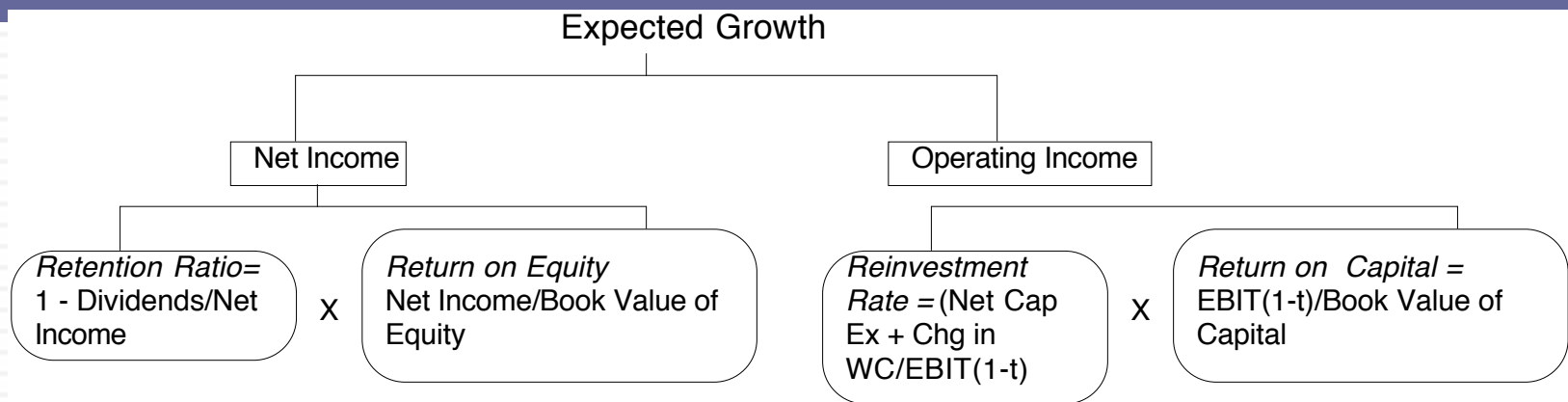

Adjust EBIT for

- a. Extraordinary or one-time expenses or income
- b. Operating leases and R&D
- c. Cyclical in earnings (Normalize)
- d. Acquisition Debris (Goodwill amortization etc.)

Use a marginal tax rate to be safe. A high ROC created by paying low effective taxes is not sustainable

$$ROC = \frac{EBIT (1 - \text{tax rate})}{\text{Book Value of Equity} + \text{Book value of debt} - \text{Cash}}$$

Adjust book equity for

1. Capitalized R&D
2. Acquisition Debris (Goodwill)

Adjust book value of debt for

- a. Capitalized operating leases

Use end of prior year numbers or average over the year but be consistent in your application

Operating income, Reinvestment & Return on Capital - Indofoods

	2009	2010	2011	2012	2013	Total
Revenues	37397	38403	45768	50201	57732	229501
EBIT	5004	6729	6649	6690	6222	31294
Effective tax rate	29.70%	27.57%	23.01%	24.24%	26.83%	26.27%
Operating Margin	13.38%	17.52%	14.53%	13.33%	10.78%	13.64%
Cap Ex	3090	2576	2915	4779	6541	19901
Acquisitions	0	275	15	200	2970	3460
Depreciation	1130	252	986	1134	1545	5047
Net Cap Ex	1960	2599	1944	3845	7966	18314
Chg in WC	26.55	40.24	294.60	177.32	301.24	839.95
Reinvestment	1986.55	2639.24	2238.60	4022.32	8267.24	19153.95
EBIT (1- t)	3517.81	4873.81	5119.07	5068.34	4552.64	23131.67
Reinvestment rate	52.22%	51.50%	38.98%	76.63%	170.71%	78.03%
Book Debt	16426	16927	14326	13686	15326	76691
Book Equity	8572	10155	16781	19388	21206	76102
Cash	4894	4806	10908	13630	13899	48137
Invested Capital	20104	22276	20199	19444	22633	104656
ROIC	17.50%	21.88%	25.34%	26.07%	20.12%	22.10%

Sounds simple, right? But companies seem to have trouble in practice

ROIC versus Cost of Capital: A Global Assessment for 2013

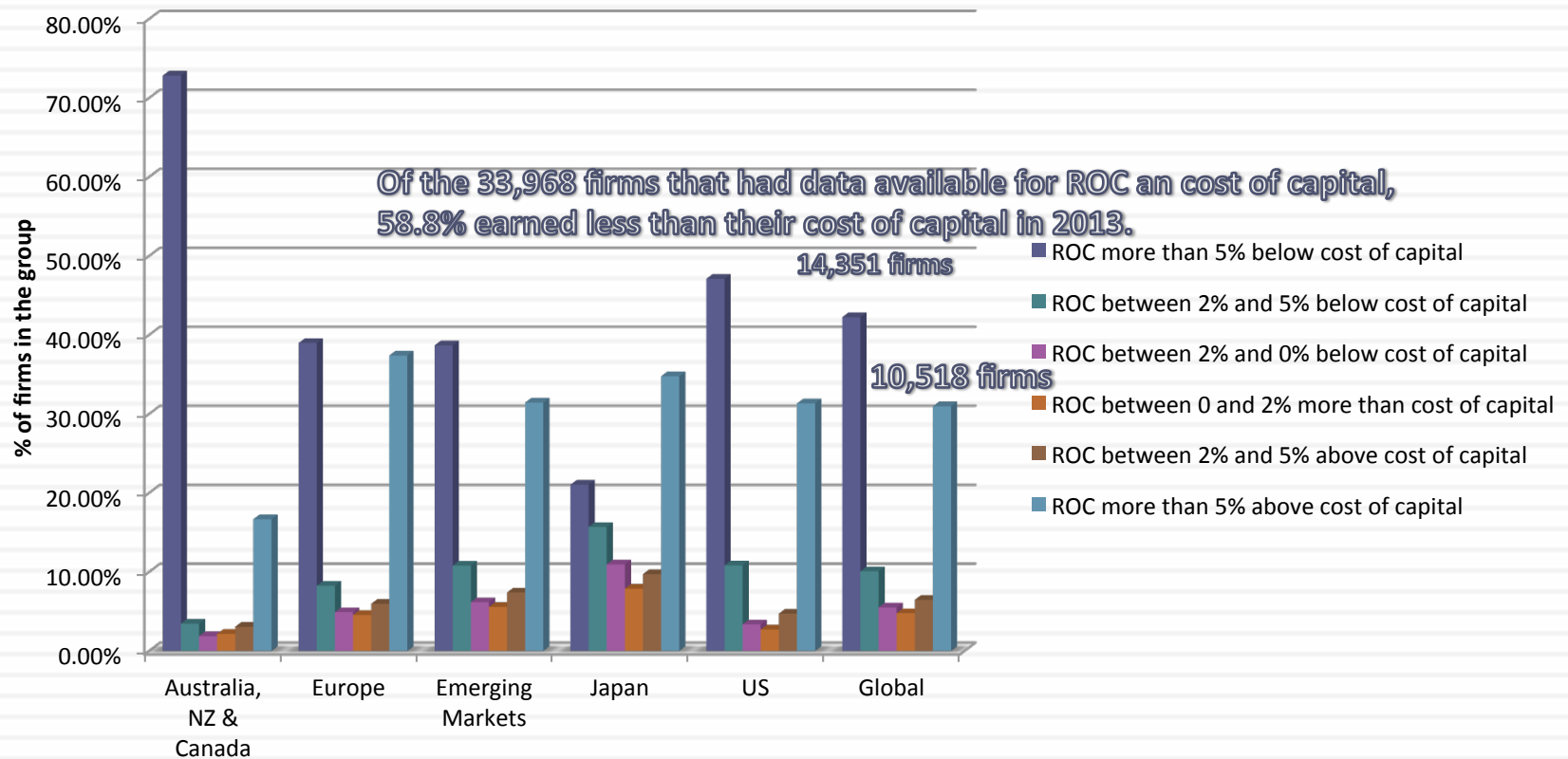

IX. All good things come to an end..And the terminal value is not an ATM...

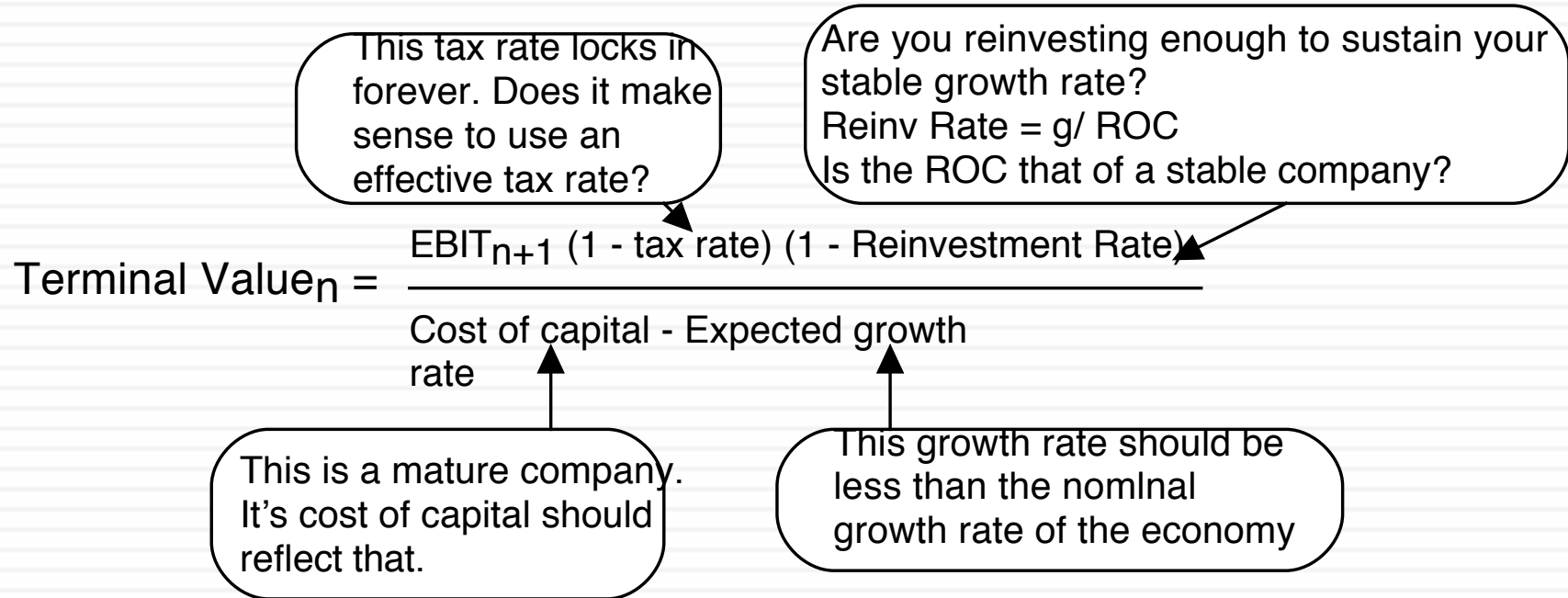

Terminal Value and Growth

<i>Stable growth rate</i>	<i>Amgen</i>	<i>Tata Motors</i>	<i>Indofoods</i>
0%	\$150,652	435,686₹	IDR 147,680
1%	\$154,479	435,686₹	IDR 150,142
2%	\$160,194	435,686₹	IDR 153,086
3%	\$167,784	435,686₹	IDR 156,670
4%	\$179,099	435,686₹	IDR 161,128
5%		435,686₹	IDR 166,824
			IDR 174,358
Riskfree rate	4.78%	5%	6.24%
ROIC	10%	10.39%	15.00%
Cost of capital	8.08%	10.39%	12.20%

Aswath Damodaran



THE LOOSE ENDS IN VALUATION...

Aswath Damodaran

Getting from DCF to value per share: The Loose Ends

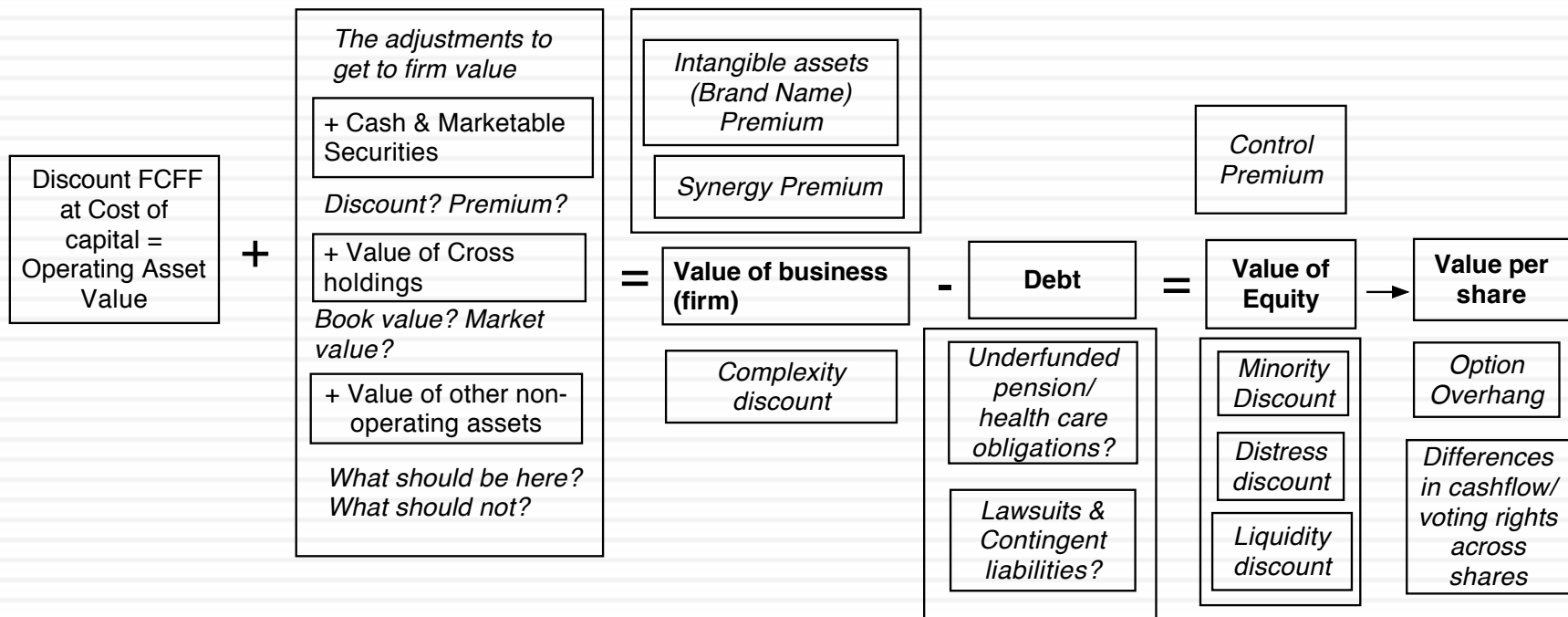

1. The Value of Cash

An Exercise in Cash Valuation

	Company A	Company B	Company C
Enterprise Value	\$ 1 billion	\$ 1 billion	\$ 1 billion
Cash	\$ 100 mil	\$ 100 mil	\$ 100 mil
Return on Capital	10%	5%	22%
Cost of Capital	10%	10%	12%
Trades in	US	US	Argentina

- In which of these companies is cash most likely to trade at face value, at a discount and at a premium?

Cash: Discount or Premium?

*Market Value of \$ 1 in cash:
Estimates obtained by regressing Enterprise Value against Cash Balances*

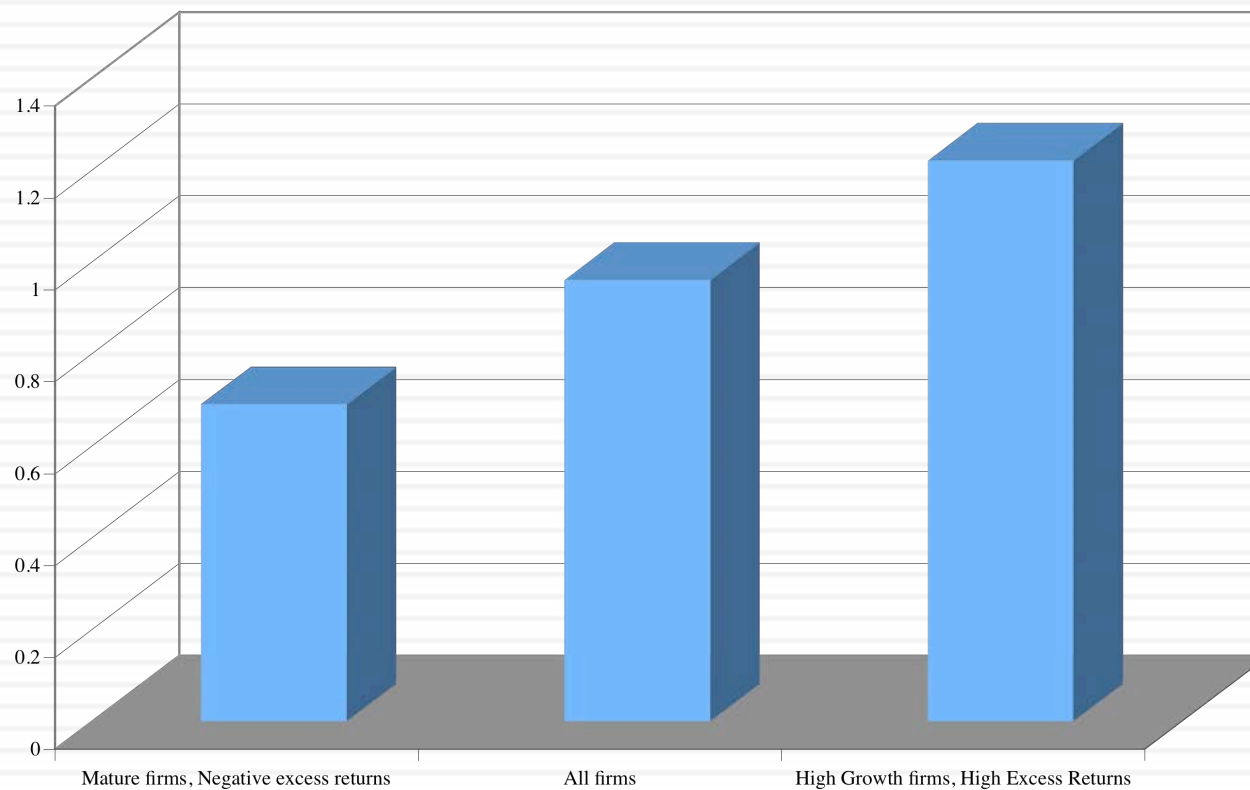

2. Dealing with Holdings in Other firms

- Holdings in other firms can be categorized into
 - ▣ Minority passive holdings, in which case only the dividend from the holdings is shown in the balance sheet
 - ▣ Minority active holdings, in which case the share of equity income is shown in the income statements
 - ▣ Majority active holdings, in which case the financial statements are consolidated.
- We tend to be sloppy in practice in dealing with cross holdings. After valuing the operating assets of a firm, using consolidated statements, it is common to add on the balance sheet value of minority holdings (which are in book value terms) and subtract out the minority interests (again in book value terms), representing the portion of the consolidated company that does not belong to the parent company.

How to value holdings in other firms.. In a perfect world..

- In a perfect world, we would strip the parent company from its subsidiaries and value each one separately. The value of the combined firm will be
 - ▣ Value of parent company + Proportion of value of each subsidiary
- To do this right, you will need to be provided detailed information on each subsidiary to estimate cash flows and discount rates.

Two compromise solutions...

- The market value solution: When the subsidiaries are publicly traded, you could use their traded market capitalizations to estimate the values of the cross holdings. You do risk carrying into your valuation any mistakes that the market may be making in valuation.
- The relative value solution: When there are too many cross holdings to value separately or when there is insufficient information provided on cross holdings, you can convert the book values of holdings that you have on the balance sheet (for both minority holdings and minority interests in majority holdings) by using the average price to book value ratio of the sector in which the subsidiaries operate.

Tata Motor's Cross Holdings

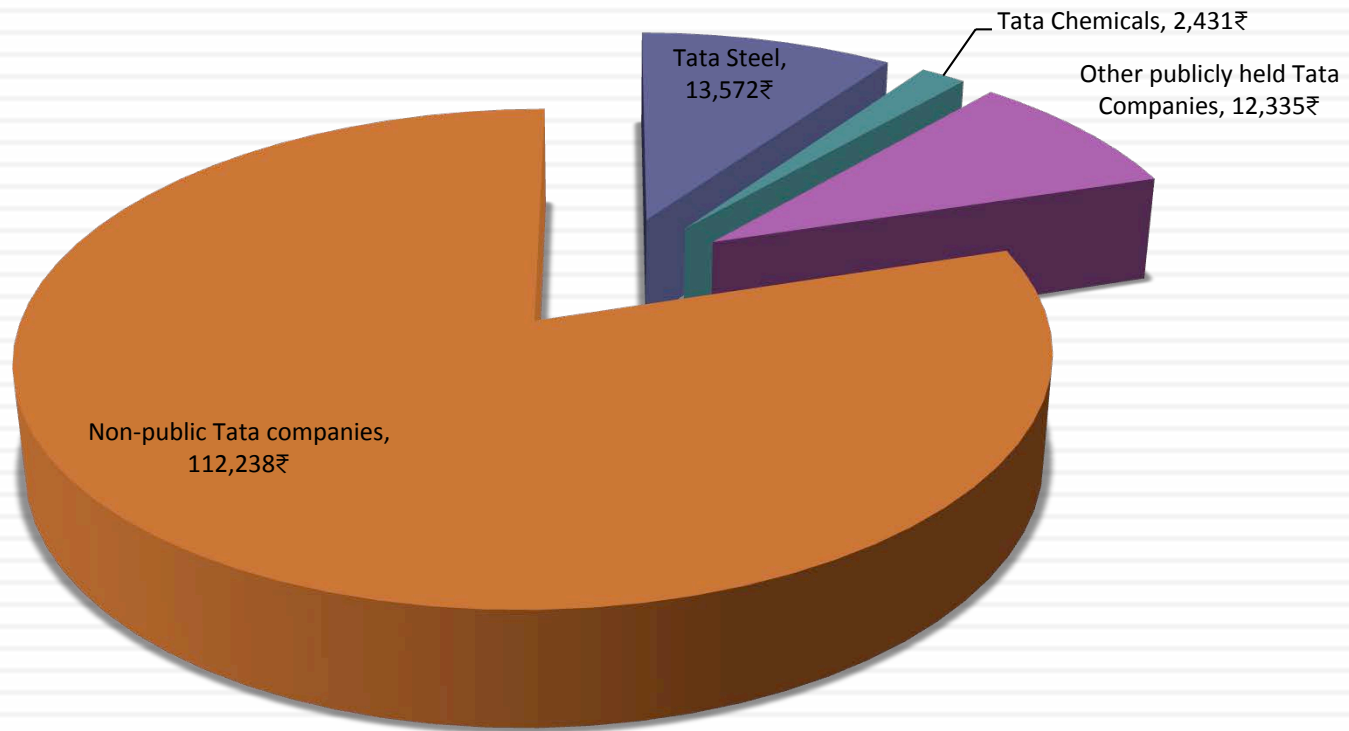

Indofoods: From operating assets to equity value

PV of cash flows during high growth =	18054	25.35%		
PV of terminal value	53168	74.65%		
Value of operating assets	71222	71222		
+ Cash		18367		
Value of firm		89589	89589	
- Debt			27492	
Value of equity in consolidated companies			62097	62097
- Value of minority interests				14725
Value of equity in company				47372

3. Other Assets that have not been counted yet..

- Unutilized assets: If you have assets or property that are not being utilized (vacant land, for example), you have not valued it yet. You can assess a market value for these assets and add them on to the value of the firm.
- Overfunded pension plans: If you have a defined benefit plan and your assets exceed your expected liabilities, you could consider the over funding with two caveats:
 - Collective bargaining agreements may prevent you from laying claim to these excess assets.
 - There are tax consequences. Often, withdrawals from pension plans get taxed at much higher rates.
- **Do not double count an asset.** If you count the income from an asset in your cash flows, you cannot count the market value of the asset in your value.

The “real estate” play

- Indofoods has real estate investments underlying its plantations (which are being used to generate its operating income). Assume that you estimate a real estate value of 40,000 billion IDR for the real estate. Can you add this value on to your DCF value?
 - a. Yes.
 - b. No.
 - c. Depends
- What would you do if the value of the land under the plantations exceeds the present value that you have estimated for them as plantations?
 - a. Nothing
 - b. Use the higher of the two values
 - c. Use the lower of the two values
 - d. Use a weighted average of the two values

4. A Discount for Complexity: An Experiment

	Company A	Company B
Operating Income	\$ 1 billion	\$ 1 billion
Tax rate	40%	40%
ROIC	10%	10%
Expected Growth	5%	5%
Cost of capital	8%	8%
Business Mix	Single	Multiple Businesses
Holdings	Simple	Complex
Accounting	Transparent	Opaque

□ Which firm would you value more highly?

Measuring Complexity: Volume of Data in Financial Statements

<i>Company</i>	<i>Number of pages in last 10Q</i>	<i>Number of pages in last 10K</i>
General Electric	65	410
Microsoft	63	218
Wal-mart	38	244
Exxon Mobil	86	332
Pfizer	171	460
Citigroup	252	1026
Intel	69	215
AIG	164	720
Johnson & Johnson	63	218
IBM	85	353

Measuring Complexity: A Complexity Score

Item	Factors	Follow-up Question	Answer	Weighting factor	Gerdau Score	GE Score
Operating Income	1. Multiple Businesses	Number of businesses (with more than 10% of revenues) =	1	2.00	2	30
	2. One-time income and expenses	Percent of operating income =	10%	10.00	1	0.8
	3. Income from unspecified sources	Percent of operating income =	0%	10.00	0	1.2
	4. Items in income statement that are volatile	Percent of operating income =	15%	5.00	0.75	1
Tax Rate	1. Income from multiple locales	Percent of revenues from non-domestic locales =	70%	3.00	2.1	1.8
	2. Different tax and reporting books	Yes or No	No	Yes=3	0	3
	3. Headquarters in tax havens	Yes or No	No	Yes=3	0	0
	4. Volatile effective tax rate	Yes or No	Yes	Yes=2	2	0
Capital Expenditures	1. Volatile capital expenditures	Yes or No	Yes	Yes=2	2	2
	2. Frequent and large acquisitions	Yes or No	Yes	Yes=4	4	4
	3. Stock payment for acquisitions and investments	Yes or No	No	Yes=4	0	4
Working capital	1. Unspecified current assets and current liabilities	Yes or No	No	Yes=3	0	0
	2. Volatile working capital items	Yes or No	Yes	Yes=2	2	2
Expected Growth rate	1. Off-balance sheet assets and liabilities (operating leases and R&D)	Yes or No	No	Yes=3	0	3
	2. Substantial stock buybacks	Yes or No	No	Yes=3	0	3
	3. Changing return on capital over time	Is your return on capital volatile?	Yes	Yes=5	5	5
	4. Unsustainably high return	Is your firm's ROC much higher than industry average?	No	Yes=5	0	0
Cost of capital	1. Multiple businesses	Number of businesses (more than 10% of revenues) =	1	1.00	1	20
	2. Operations in emerging markets	Percent of revenues=	50%	5.00	2.5	2.5
	3. Is the debt market traded?	Yes or No	No	No=2	2	0
	4. Does the company have a rating?	Yes or No	Yes	No=2	0	0
	5. Does the company have off-balance sheet debt?	Yes or No	No	Yes=5	0	5
No-operating assets	Minority holdings as percent of book assets	Minority holdings as percent of book assets	0%	20.00	0	0.8
Firm to Equity value	Consolidation of subsidiaries	Minority interest as percent of book value of equity	63%	20.00	12.6	1.2
Per share value	Shares with different voting rights	Does the firm have shares with different voting rights?	Yes	Yes = 10	10	0
	Equity options outstanding	Options outstanding as percent of shares	0%	10.00	0	0.58
Complexity Score =					48.95	90.55

Dealing with Complexity

□ In Discounted Cashflow Valuation

- The Aggressive Analyst: Trust the firm to tell the truth and value the firm based upon the firm's statements about their value.
- The Conservative Analyst: Don't value what you cannot see.
- The Compromise: Adjust the value for complexity
 - Adjust cash flows for complexity
 - Adjust the discount rate for complexity
 - Adjust the expected growth rate/ length of growth period
 - Value the firm and then discount value for complexity

□ In relative valuation

- In a relative valuation, you may be able to assess the price that the market is charging for complexity:
- With the hundred largest market cap firms, for instance:

$$\text{PBV} = 0.65 + 15.31 \text{ ROE} - 0.55 \text{ Beta} + 3.04 \text{ Expected growth rate} - 0.003 \# \text{ Pages in 10K}$$

5. The Value of Synergy

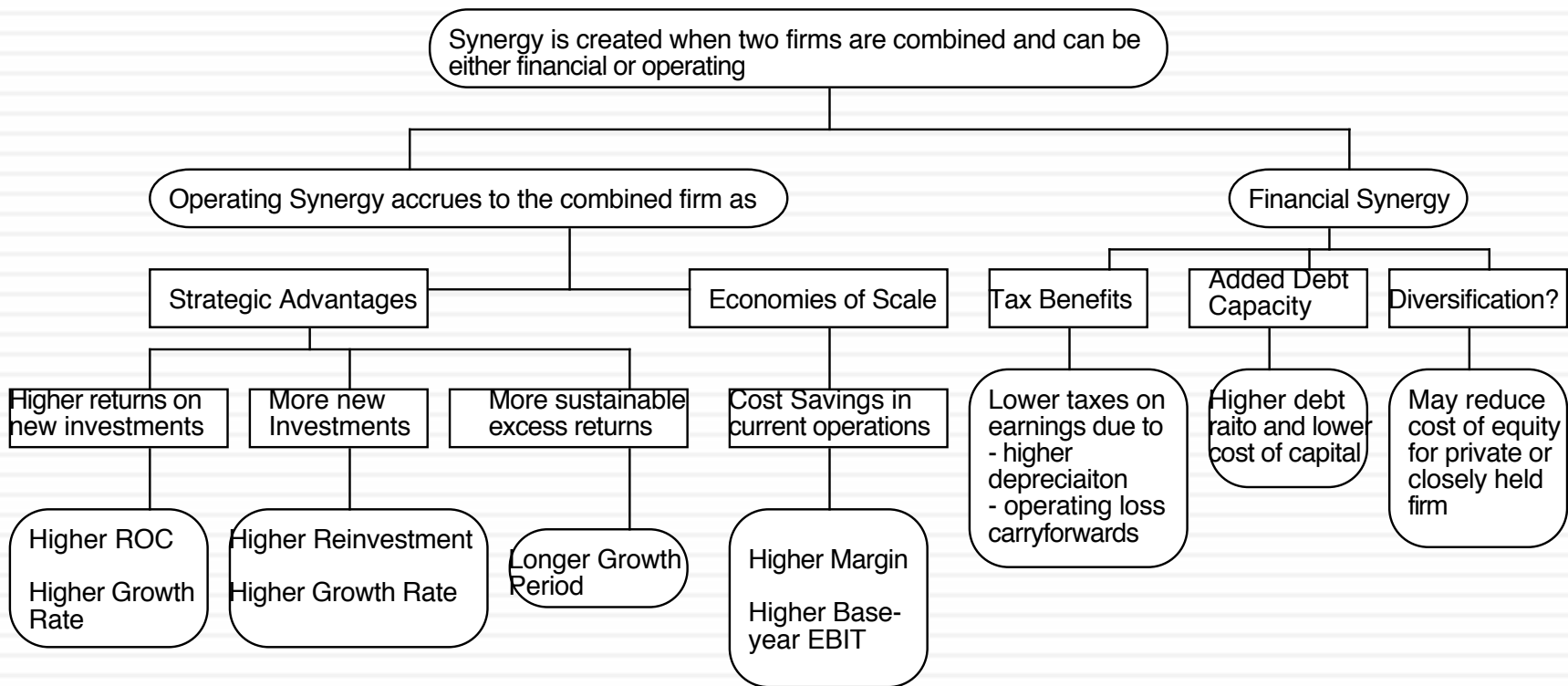

Valuing Synergy

- (1) the firms involved in the merger are valued independently, by discounting expected cash flows to each firm at the weighted average cost of capital for that firm.
- (2) the value of the combined firm, with no synergy, is obtained by adding the values obtained for each firm in the first step.
- (3) The effects of synergy are built into expected growth rates and cashflows, and the combined firm is re-valued with synergy.

$$\text{Value of Synergy} = \text{Value of the combined firm, with synergy} - \text{Value of the combined firm, without synergy}$$

Valuing Synergy: P&G + Gillette

Assume that \$250 million in operating expenses will be cut immediately. Translates into an after-tax increase in operating income of approximately \$158 million.

	P&G	Gillette	Piglet: No Synergy	Piglet: Synergy
Free Cashflow to Equity	\$5,864.74	\$1,547.50	\$7,412.24	\$7,569.73
Growth rate for first 5 years	12%	10%	11.58%	12.50%
Growth rate after five years	4%	4%	4.00%	4.00%
Beta	0.90	0.80	0.88	0.88
Cost of Equity	7.90%	7.50%	7.81%	7.81%
Value of Equity	\$221,292	\$59,878	\$281,170	\$298,355

Assume that the combined company will grow at a faster rate (for the next decade) starting immediately.

6. Brand name, great management, superb product ...Are we short changing intangibles?

- There is often a temptation to add on premiums for intangibles. Here are a few examples.
 - ▣ Brand name
 - ▣ Great management
 - ▣ Loyal workforce
 - ▣ Technological prowess
- There are two potential dangers:
 - ▣ For some assets, the value may already be in your value and adding a premium will be double counting.
 - ▣ For other assets, the value may be ignored but incorporating it will not be easy.

Valuing Brand Name

	Coca Cola	With Cott Margins
Current Revenues =	\$21,962.00	\$21,962.00
Length of high-growth period	10	10
Reinvestment Rate =	50%	50%
Operating Margin (after-tax)	15.57%	5.28%
Sales/Capital (Turnover ratio)	1.34	1.34
Return on capital (after-tax)	20.84%	7.06%
Growth rate during period (g) =	10.42%	3.53%
Cost of Capital during period =	7.65%	7.65%
Stable Growth Period		
Growth rate in steady state =	4.00%	4.00%
Return on capital =	7.65%	7.65%
Reinvestment Rate =	52.28%	52.28%
Cost of Capital =	7.65%	7.65%
Value of Firm =	\$79,611.25	\$15,371.24

7. Be circumspect about defining debt for cost of capital purposes...

- General Rule: Debt generally has the following characteristics:
 - ▣ Commitment to make fixed payments in the future
 - ▣ The fixed payments are tax deductible
 - ▣ Failure to make the payments can lead to either default or loss of control of the firm to the party to whom payments are due.
- Defined as such, debt should include
 - ▣ All interest bearing liabilities, short term as well as long term
 - ▣ All leases, operating as well as capital
- Debt should not include
 - ▣ Accounts payable or supplier credit

But should consider other potential liabilities when getting to equity value...

- If you have under funded pension fund or health care plans, you should consider the under funding at this stage in getting to the value of equity.
 - ▣ If you do so, you should not double count by also including a cash flow line item reflecting cash you would need to set aside to meet the unfunded obligation.
 - ▣ You should not be counting these items as debt in your cost of capital calculations....
- If you have contingent liabilities - for example, a potential liability from a lawsuit that has not been decided - you should consider the expected value of these contingent liabilities
 - ▣ Value of contingent liability = Probability that the liability will occur * Expected value of liability

8. The Value of Control

- The value of the control premium that will be paid to acquire a block of equity will depend upon two factors -
 - Probability that control of firm will change: This refers to the probability that incumbent management will be replaced. this can be either through acquisition or through existing stockholders exercising their muscle.
 - Value of Gaining Control of the Company: The value of gaining control of a company arises from two sources - the increase in value that can be wrought by changes in the way the company is managed and run, and the side benefits and perquisites of being in control
 - Value of Gaining Control = Present Value (Value of Company with change in control - Value of company without change in control) + Side Benefits of Control

Increase Cash Flows

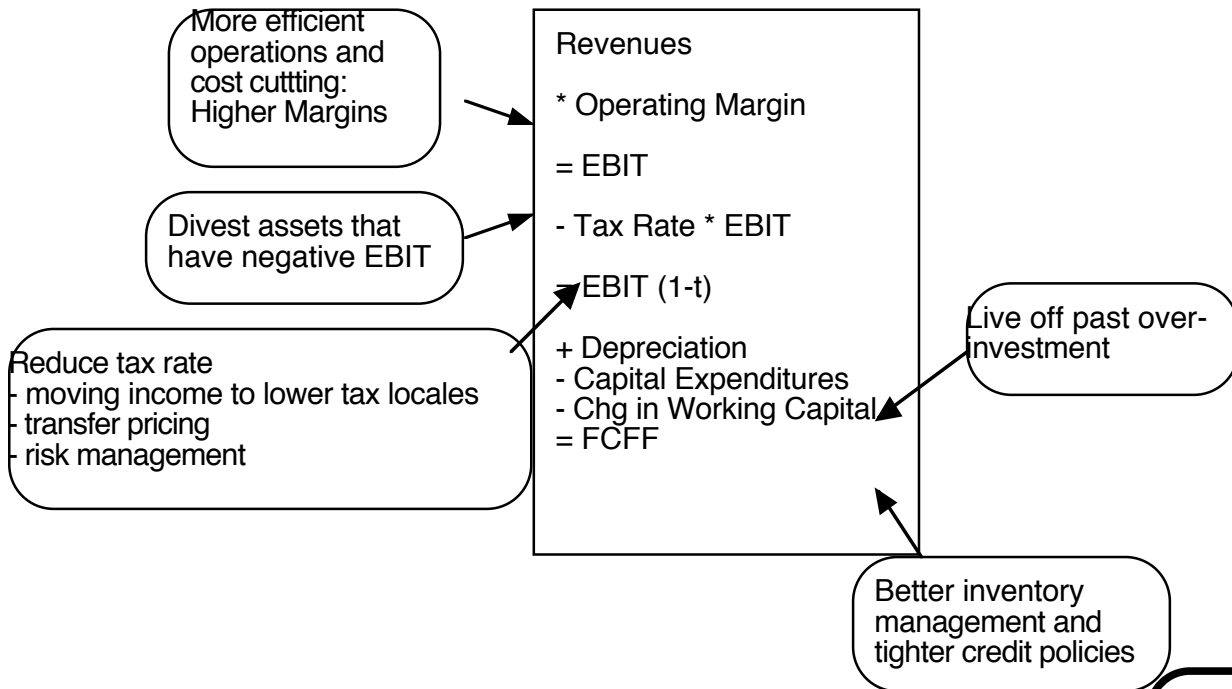

Reduce the cost of capital

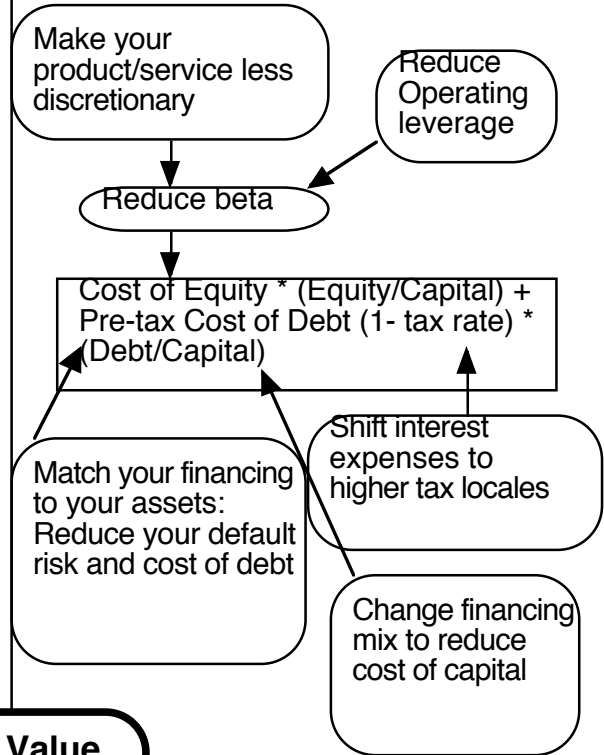

Firm Value

Increase Expected Growth

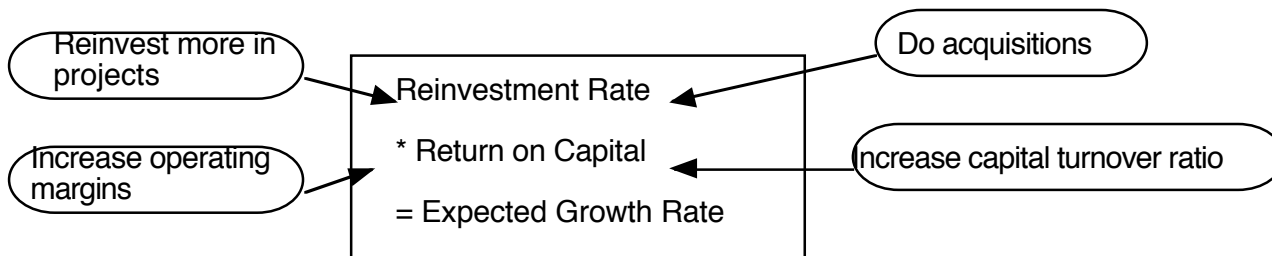

Increase length of growth period

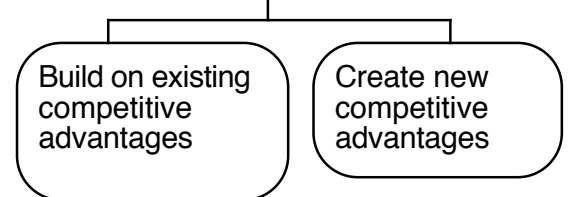

Adris Grupa (Status Quo): 4/2010

Current Cashflow to Firm
 EBIT(1-t) : 436 HRK
 - Nt CpX 3 HRK
 - Chg WC -118 HRK
 = FCFF 551 HRK
 Reinv Rate = $(3-118)/436 = -26.35\%$;
 Tax rate = 17.35%
 Return on capital = 8.72%

Average from 2004-09
 70.83%

Reinvestment Rate
 70.83%

Expected Growth from new inv.
 $.7083 \cdot .0969 = 0.0686$
 or 6.86%

Average from 2004-09
 9.69%

Return on Capital
 9.69%

Stable Growth
 $g = 4\%$; Beta = 0.80
 Country Premium = 2%
 Cost of capital = 9.92%
 Tax rate = 20.00%
 ROC = 9.92%;
 Reinvestment Rate = $g/ROC = 4/9.92 = 40.32\%$

Terminal Value₅ = $365 / (.0992 - .04) = 6170$ HRK

Op. Assets 4312
 + Cash: 1787
 - Debt 141
 - Minority int 465
 = Equity 5,484
 / (Common + Preferred shares)
 Value non-voting share 335 HRK/share

Year	1	2	3	4	5	
EBIT (1-t)	HRK 466	HRK 498	HRK 532	HRK 569	HRK 608	
- Reinvestment	HRK 330	HRK 353	HRK 377	HRK 403	HRK 431	
FCFF	HRK 136	HRK 145	HRK 155	HRK 166	HRK 177	
						612 246 365

Discount at \$ Cost of Capital (WACC) = 10.7% (.974) + 5.40% (0.026) = 10.55%

Cost of Equity
 10.70%

Cost of Debt
 $(4.25\% + 0.5\% + 2\%)(1 - .20) = 5.40\%$

Weights
 E = 97.4% D = 2.6%

On May 1, 2010
 AG Pfd price = 279 HRK
 AG Common = 345 HRK

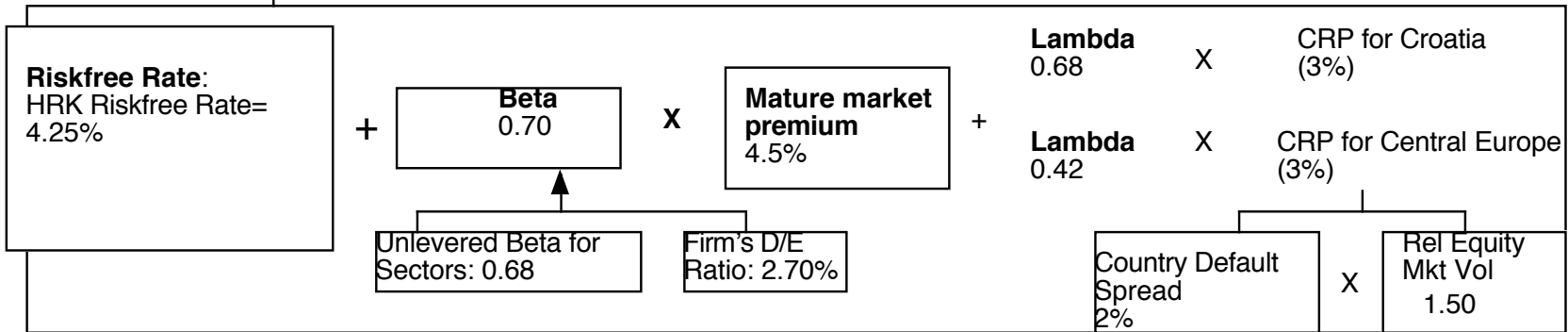

Adris Grupa: 4/2010 (Restructured)

Increased ROIC to cost of capital

Current Cashflow to Firm
 EBIT(1-t) : 436 HRK
 - Nt CpX 3 HRK
 - Chg WC -118 HRK
 = FCFF 551 HRK
 Reinv Rate = (3-118)/436 = -26.35%;
 Tax rate = 17.35%
 Return on capital = 8.72%

Average from 2004-09
70.83%

Reinvestment Rate
70.83%

Expected Growth from new inv.
 $.7083 \times .01054 = 0.0074$
 or 6.86%

Return on Capital
10.54%

Stable Growth
 $g = 4\%$; Beta = 0.80
 Country Premium = 2%
 Cost of capital = 9.65%
 Tax rate = 20.00%
 ROC = 9.94%;
 Reinvestment Rate = $g/ROC = 4/9.65 = 41.47\%$

Terminal Value₅ = $367 / (.0965 - .04) = 6508$ HRK

HKR Cashflows

Op. Assets 4545
 + Cash: 1787
 - Debt 141
 - Minority int 465
 = Equity 5,735

 Value/non-voting 334
 Value/voting 362

Year	1	2	3	4	5	
EBIT (1-t)	HRK 469	HRK 503	HRK 541	HRK 581	HRK 623	628
- Reinvestment	HRK 332	HRK 356	HRK 383	HRK 411	HRK 442	246
FCFF	HRK 137	HRK 147	HRK 158	HRK 169	HRK 182	367

Discount at \$ Cost of Capital (WACC) = 11.12% (.90) + 8.20% (0.10) = 10.55%

Changed mix of debt and equity to optimal

On May 1, 2010
 AG Pfd price = 279 HRK
 AG Common = 345 HRK

Cost of Equity 11.12%

Cost of Debt
 $(4.25\% + 4\% + 2\%) (1 - .20) = 8.20\%$

Weights
 E = 90 % D = 10 %

Riskfree Rate:
 HRK Riskfree Rate = 4.25%

+

Beta
0.75

x

Mature market premium
4.5%

+

Lambda
0.68

x

CRP for Croatia (3%)

Lambda
0.42

x

CRP for Central Europe (3%)

Unlevered Beta for Sectors: 0.68

Firm's D/E Ratio: 11.1%

Country Default Spread 2%

x

Rel Equity Mkt Vol 1.50

Value of Control and the Value of Voting Rights

- Adris Grupa has two classes of shares outstanding: 9.616 million voting shares and 6.748 million non-voting shares.
- To value a non-voting share, we assume that all non-voting shares essentially have to settle for status quo value. All shareholders, common and preferred, get an equal share of the status quo value.

Status Quo Value of Equity = 5,484 million HKR

Value for a non-voting share = $5484 / (9.616 + 6.748) = 334$ HKR/share

- To value a voting share, we first value control in Adris Grup as the difference between the optimal and the status quo value:

Value of control at Adris Grupa = $5,735 - 5484 = 249$ million HKR

Value per voting share = 334 HKR + $249 / 9.616 = 362$ HKR

Aswath Damodaran



THE DARK SIDE OF VALUATION: VALUING DIFFICULT-TO-VALUE COMPANIES



The fundamental determinants of value...

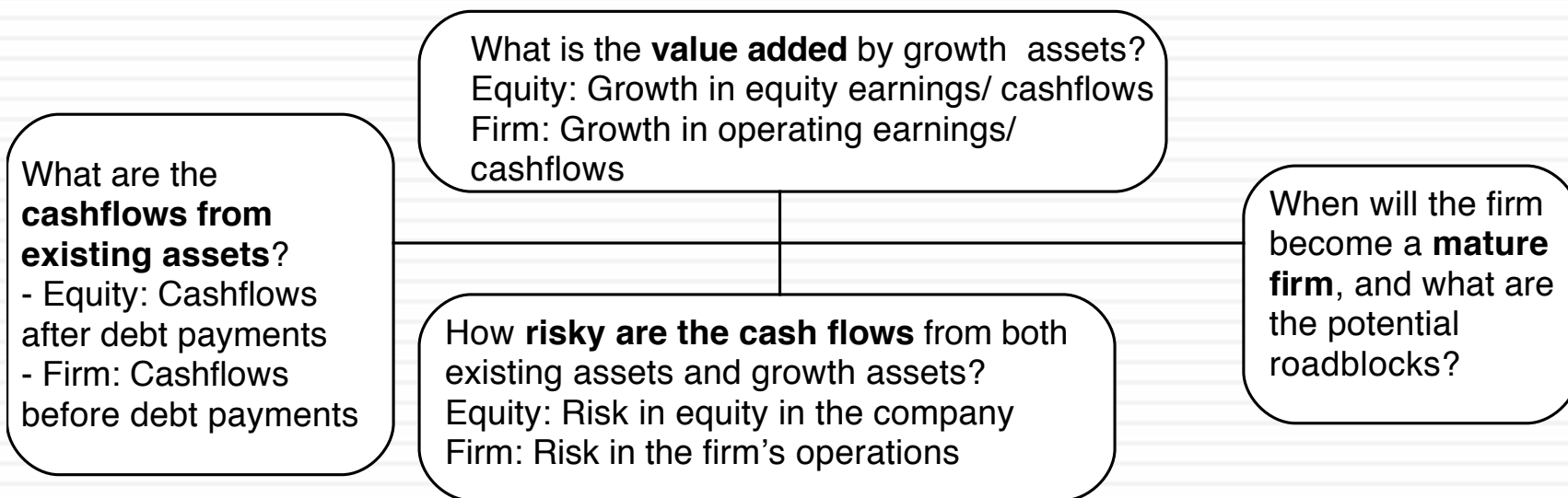

The Dark Side of Valuation...

- Valuing stable, money making companies with consistent and clear accounting statements, a long and stable history and lots of comparable firms is easy to do.
- The true test of your valuation skills is when you have to value “difficult” companies. In particular, the challenges are greatest when valuing:
 - Young companies, early in the life cycle, in young businesses
 - Companies that don’t fit the accounting mold
 - Companies that face substantial truncation risk (default or nationalization risk)

Difficult to value companies...

- Across the life cycle:
 - Young, growth firms: Limited history, small revenues in conjunction with big operating losses and a propensity for failure make these companies tough to value.
 - Mature companies in transition: When mature companies change or are forced to change, history may have to be abandoned and parameters have to be reestimated.
 - Declining and Distressed firms: A long but irrelevant history, declining markets, high debt loads and the likelihood of distress make them troublesome.
- Across sectors
 - Financial service firms: Opacity of financial statements and difficulties in estimating basic inputs leave us trusting managers to tell us what's going on.
 - Commodity and cyclical firms: Dependence of the underlying commodity prices or overall economic growth make these valuations susceptible to macro factors.
 - Firms with intangible assets: Accounting principles are left to the wayside on these firms.
- Across the ownership cycle
 - Privately owned businesses: Exposure to firm specific risk and illiquidity bedevil valuations.
 - Venture Capital (VC) and private equity: Different equity investors, with different perceptions of risk.
 - Closely held public firms: Part private and part public, sharing the troubles of both.

I. The challenge with young companies...

Figure 5.2: Estimation Issues - Young and Start-up Companies

Making judgments on revenues/ profits difficult because you cannot draw on history. If you have no product/ service, it is difficult to gauge market potential or profitability. The company's entire value lies in future growth but you have little to base your estimate on.

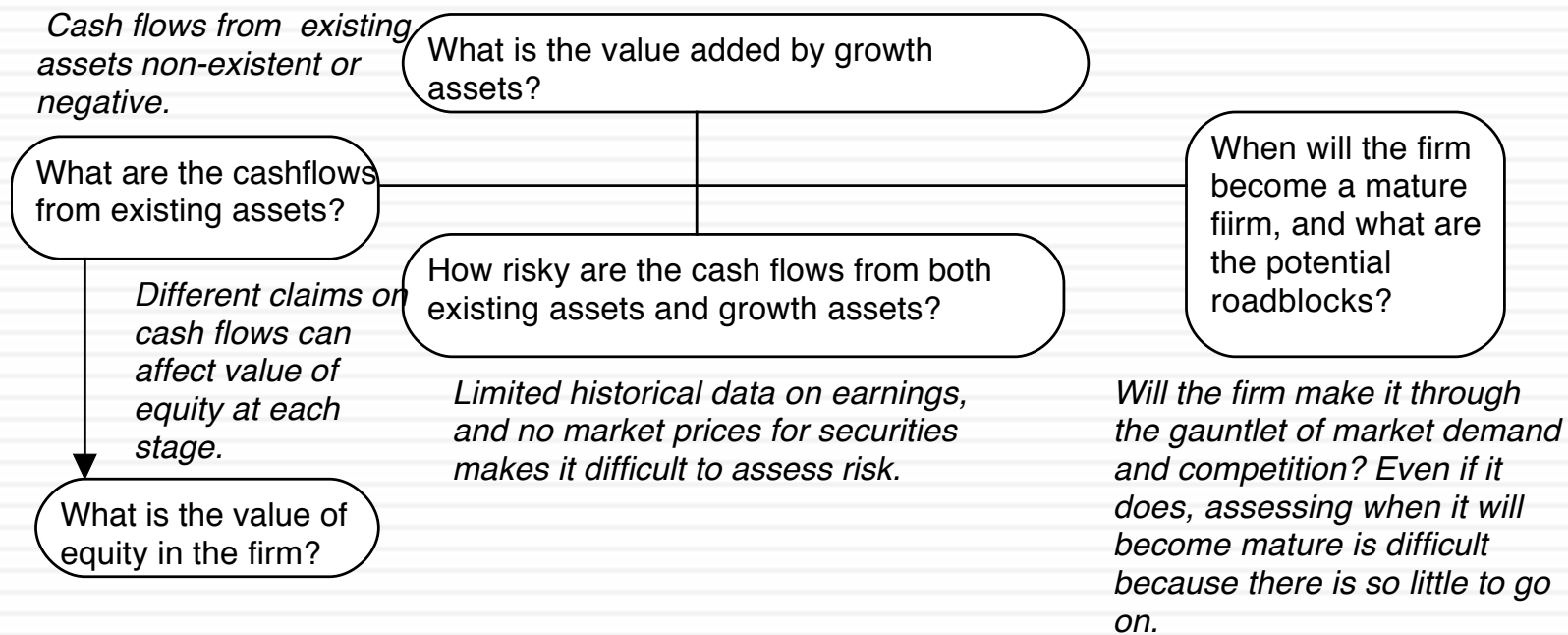

Upping the ante.. Young companies in young businesses...

- When valuing a business, we generally draw on three sources of information
 - ▣ The firm's current financial statement
 - How much did the firm sell?
 - How much did it earn?
 - ▣ The firm's financial history, usually summarized in its financial statements.
 - How fast have the firm's revenues and earnings grown over time?
 - What can we learn about cost structure and profitability from these trends?
 - Susceptibility to macro-economic factors (recessions and cyclical firms)
 - ▣ The industry and comparable firm data
 - What happens to firms as they mature? (Margins.. Revenue growth... Reinvestment needs... Risk)
- It is when valuing these companies that you find yourself tempted by the dark side, where
 - ▣ "Paradigm shifts" happen...
 - ▣ New metrics are invented ...
 - ▣ The story dominates and the numbers lag...

Amazon in January 2000

Sales to capital ratio and expected margin are retail industry average numbers

Stable Growth

- Stable Revenue Growth: 6%
- Stable Operating Margin: 10.00%
- Stable ROC=20% Reinvest 30% of EBIT(1-t)

From previous years

- Current Revenue: \$ 1,117
- Current Margin: -36.71%
- EBIT: -410m
- NOL: 500 m

- Sales Turnover Ratio: 3.00
- Revenue Growth: 42%
- Competitive Advantages
- Expected Margin: -> 10.00%

Terminal Value = $1881 / (.0961 - .06) = 52,148$

Value of Op Assets \$ 15,170
 + Cash \$ 26
 = Value of Firm \$15,196
 - Value of Debt \$ 349
 = Value of Equity \$14,847
 - Equity Options \$ 2,892
 Value per share \$ 35.08

All existing options valued as options, using current stock price of \$84.

	150.00%	100.00%	75.00%	50.00%	30.00%	25.20%	20.40%	15.60%	10.80%	6.00%	Term. Year
Revenues	\$ 2,793	\$ 5,585	\$ 9,774	\$ 14,661	\$ 19,059	\$ 23,862	\$ 28,729	\$ 33,211	\$ 36,798	\$ 39,006	\$ 41,346
Operating Margin	-13.35%	-1.68%	4.16%	7.08%	8.54%	9.27%	9.64%	9.82%	9.91%	9.95%	10.00%
EBIT	-\$373	-\$94	\$407	\$1,038	\$1,628	\$2,212	\$2,768	\$3,261	\$3,646	\$3,883	\$4,135
EBIT(1-t)	-\$373	-\$94	\$407	\$871	\$1,058	\$1,438	\$1,799	\$2,119	\$2,370	\$2,524	\$2,688
- Reinvestment	\$600	\$967	\$1,420	\$1,663	\$1,543	\$1,688	\$1,721	\$1,619	\$1,363	\$961	\$155
FCFF	-\$931	-\$1,024	-\$989	-\$758	-\$408	-\$163	\$177	\$625	\$1,174	\$1,788	\$1,881

	1	2	3	4	5	6	7	8	9	10	Forever
Cost of Equity	12.90%	12.90%	12.90%	12.90%	12.90%	12.42%	11.94%	11.46%	10.98%	10.50%	
Cost of Debt	8.00%	8.00%	8.00%	8.00%	8.00%	7.80%	7.75%	7.67%	7.50%	7.00%	
After-tax cost of debt	8.00%	8.00%	8.00%	6.71%	5.20%	5.07%	5.04%	4.98%	4.88%	4.55%	
Cost of Capital	12.84%	12.84%	12.84%	12.83%	12.81%	12.13%	11.62%	11.08%	10.49%	9.61%	

Cost of Equity 12.90%

Used average interest coverage ratio over next 5 years to get BBB rating.

Cost of Debt 6.5%+1.5%=8.0%
 Tax rate = 0% -> 35%

Weights Debt= 1.2% -> 15%

Amazon was trading at \$84 in January 2000.

Pushed debt ratio to retail industry average of 15%.

Dot.com retailers for first 5 years
 Conventional retailers after year 5

Riskfree Rate:
 T. Bond rate = 6.5%

+ **Beta 1.60 -> 1.00** X **Risk Premium 4%**

- Internet/Retail
- Operating Leverage
- Current D/E: 1.21%
- Base Equity Premium
- Country Risk Premium

Lesson 1: Don't trust regression betas....

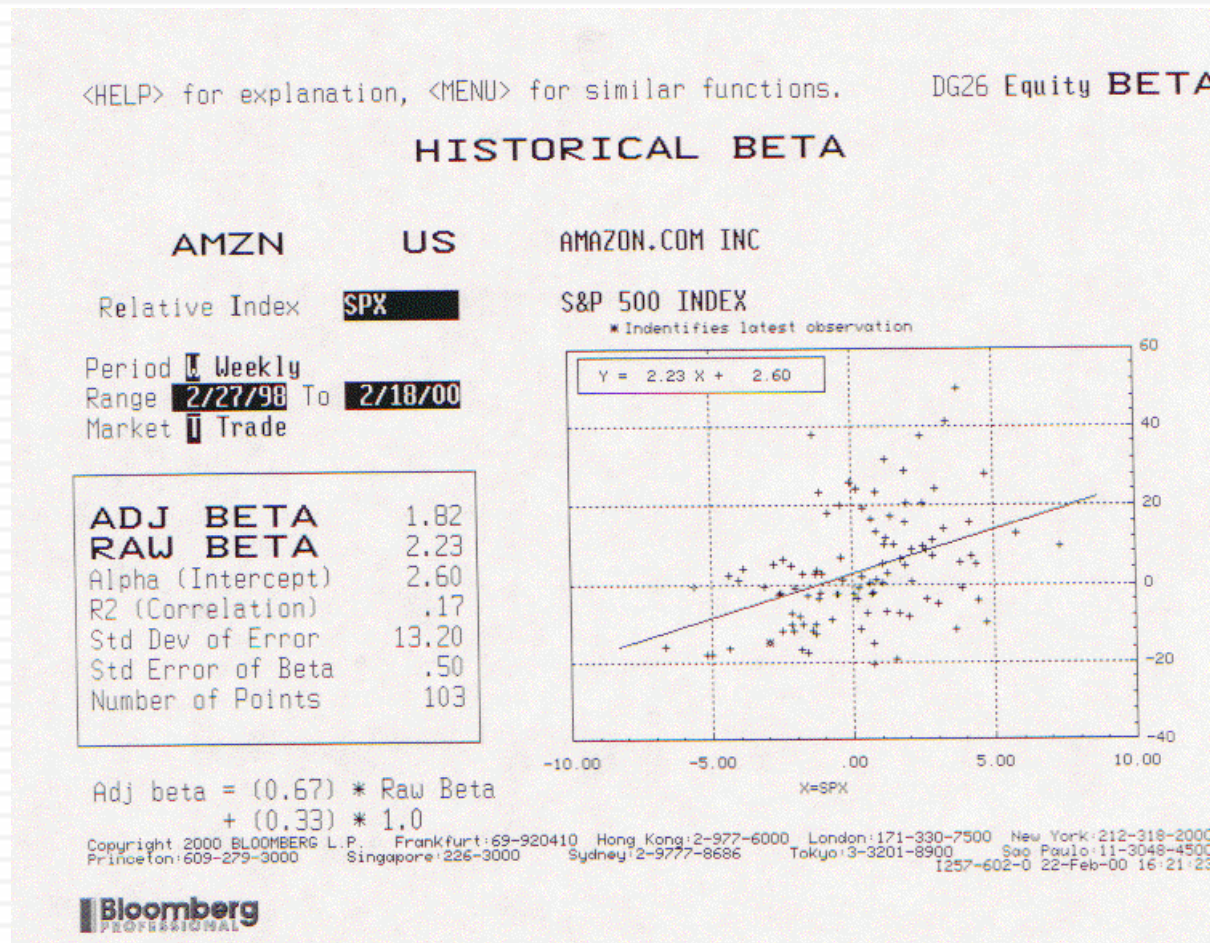

Lesson 2: Work backwards and keep it simple...

Year	Revenue Growth	Sales	Operating Margin	EBIT	EBIT (1-t)
Tr 12 mths		\$1,117	-36.71%	-\$410	-\$410
1	150.00%	\$2,793	-13.35%	-\$373	-\$373
2	100.00%	\$5,585	-1.68%	-\$94	-\$94
3	75.00%	\$9,774	4.16%	\$407	\$407
4	50.00%	\$14,661	7.08%	\$1,038	\$871
5	30.00%	\$19,059	8.54%	\$1,628	\$1,058
6	25.20%	\$23,862	9.27%	\$2,212	\$1,438
7	20.40%	\$28,729	9.64%	\$2,768	\$1,799
8	15.60%	\$33,211	9.82%	\$3,261	\$2,119
9	10.80%	\$36,798	9.91%	\$3,646	\$2,370
10	6.00%	\$39,006	9.95%	\$3,883	\$2,524
TY	6.00%	\$41,346	10.00%	\$4,135	\$2,688

Lesson 3: Scaling up is hard to do...

Typically, the revenue growth rate of a newly public company outpaces its industry average for only about five years.

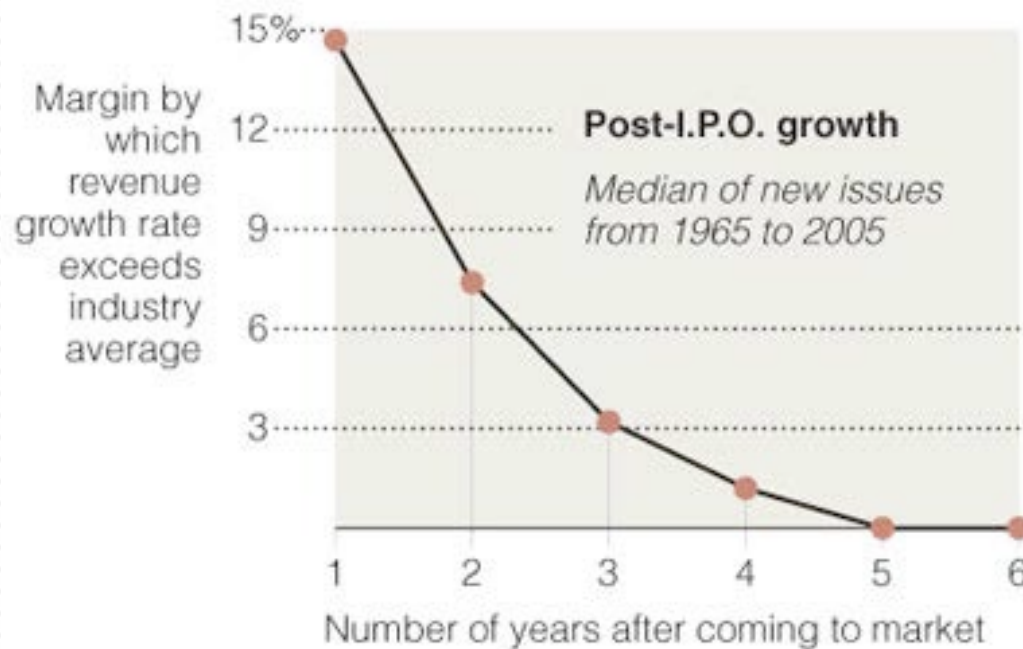

Source: Andrew Metrick

The New York Times

Lesson 4: Don't forget to pay for growth...

Year	Revenues	Δ Revenue	Sales/Cap	Δ Investment	Invested Capital	EBIT (1-t)	Imputed ROC
Tr 12 mths	\$1,117				\$ 487	-\$410	
1	\$2,793	\$1,676	3.00	\$559	\$ 1,045	-\$373	-76.62%
2	\$5,585	\$2,793	3.00	\$931	\$ 1,976	-\$94	-8.96%
3	\$9,774	\$4,189	3.00	\$1,396	\$ 3,372	\$407	20.59%
4	\$14,661	\$4,887	3.00	\$1,629	\$ 5,001	\$871	25.82%
5	\$19,059	\$4,398	3.00	\$1,466	\$ 6,467	\$1,058	21.16%
6	\$23,862	\$4,803	3.00	\$1,601	\$ 8,068	\$1,438	22.23%
7	\$28,729	\$4,868	3.00	\$1,623	\$ 9,691	\$1,799	22.30%
8	\$33,211	\$4,482	3.00	\$1,494	\$ 11,185	\$2,119	21.87%
9	\$36,798	\$3,587	3.00	\$1,196	\$ 12,380	\$2,370	21.19%
10	\$39,006	\$2,208	3.00	\$736	\$ 13,116	\$2,524	20.39%
TY	\$41,346	\$2,340	NA		Assumed to be =		20.00%

Lesson 5: There are always scenarios where the market price can be justified...

		Target pre-tax Operating Margin				
		6%	8%	10%	12%	14%
Compounded annual Revenue Growth rate	30%	\$ (1.94)	\$ 2.95	\$ 7.84	\$ 12.71	\$ 17.57
	35%	\$ 1.41	\$ 8.37	\$ 15.33	\$ 22.27	\$ 29.21
	40%	\$ 6.10	\$ 15.93	\$ 25.74	\$ 35.54	\$ 45.34
	45%	\$ 12.59	\$ 26.34	\$ 40.05	\$ 53.77	\$ 67.48
	50%	\$ 21.47	\$ 40.50	\$ 59.52	\$ 78.53	\$ 97.54
	55%	\$ 33.47	\$ 59.60	\$ 85.72	\$ 111.84	\$ 137.95
	60%	\$ 49.53	\$ 85.10	\$ 120.66	\$ 156.22	\$ 191.77

Lesson 6: Don't forget to mop up...

- Watch out for “other” equity claims: If you buy equity in a young, growth company, watch out for other (often hidden) claims on the equity that don't take the form of common shares. In particular, watch for options granted to managers, employees, venture capitalists and others (you will be surprised...).
 - ▣ Value these options as options (not at exercise value)
 - ▣ Take into consideration expectations of future option grants when computing expected future earnings/cash flows.
- Not all shares are equal: If there are differences in cash flow claims (dividends or liquidation) or voting rights across shares, value these differences.
 - ▣ Voting rights matter even at well run companies

Lesson 7: You will be wrong 100% of the time... and it really is not (always) your fault...

- No matter how careful you are in getting your inputs and how well structured your model is, your estimate of value will change both as new information comes out about the company, the business and the economy.
- As information comes out, you will have to adjust and adapt your model to reflect the information. Rather than be defensive about the resulting changes in value, recognize that this is the essence of risk.
- A test: If your valuations are unbiased, you should find yourself increasing estimated values as often as you are decreasing values. In other words, there should be equal doses of good and bad news affecting valuations (at least over time).

And the market is often “more wrong”

Amazon: Value and Price

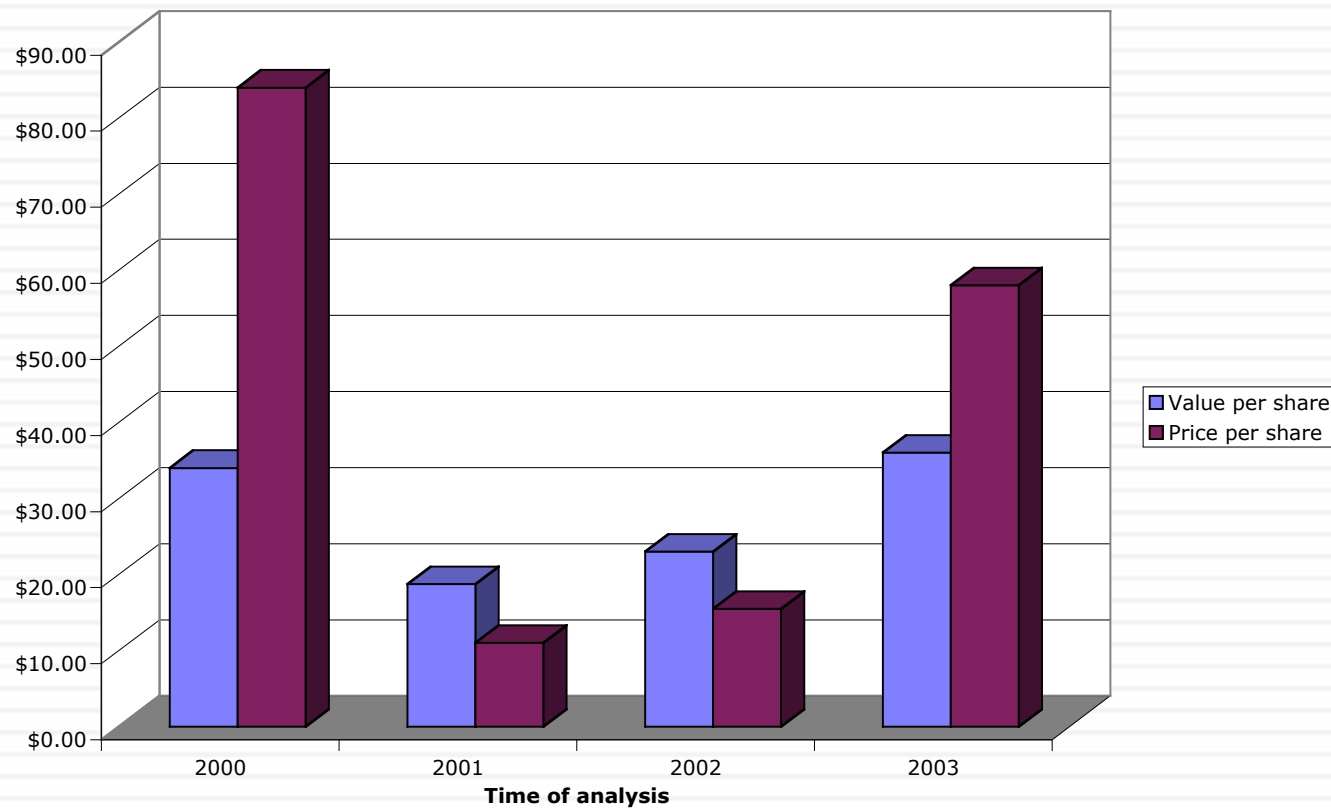

Valuing an IPO

□ Valuation issues:

- Use of the proceeds from the offering: The proceeds from the offering can be held as cash by the firm to cover future investment needs, paid to existing equity investors who want to cash out or used to pay down debt.
- Warrants/ Special deals with prior equity investors: If venture capitalists and other equity investors from earlier iterations of fund raising have rights to buy or sell their equity at pre-specified prices, it can affect the value per share offered to the public.

□ Pricing issues:

- Institutional set-up: Most IPOs are backed by investment banking guarantees on the price, which can affect how they are priced.
- Follow-up offerings: The proportion of equity being offered at initial offering and subsequent offering plans can affect pricing.

Alibaba: Pre-IPO valuation - September 2, 2014 (in US \$)

	T12M	2012-13
Revenues	\$9,268	\$4,821
Operating Income	\$4,702	\$1,777
Effective tax rate	11.92%	
Operating Margin	50.73%	

Revenue growth of 25% a year for 5 years, tapering down to 2.63% in year 10

Pre-tax operating margin decreases to 40% over time & tax rate rises to 25%

Sales to capital ratio maintained at 2.00

Stable Growth
 $g = 2.41\%$
 Cost of capital = 8%
 ROC = 8%;
 Reinvestment Rate = $2.41\%/8\% = 30.125\%$

Terminal Value₁₀ = $10,353 / (.08 - 0.0241) = \$185,198$

	1	2	3	4	5	6	7	8	9	10
Revenue growth rate	25.00%	25.00%	25.00%	25.00%	25.00%	20.48%	15.96%	11.45%	6.93%	2.41%
Revenues	\$ 11,585	\$ 14,481	\$ 18,101	\$ 22,626	\$ 28,283	\$ 34,075	\$ 39,515	\$ 44,038	\$ 47,089	\$ 48,224
EBIT (Operating margin)	49.66%	48.59%	47.51%	46.44%	45.37%	44.29%	43.22%	42.15%	41.07%	40.00%
EBIT (Operating income)	\$ 5,753	\$ 7,035	\$ 8,600	\$ 10,507	\$ 12,831	\$ 15,093	\$ 17,078	\$ 18,560	\$ 19,341	\$ 19,290
Tax rate	11.92%	11.92%	11.92%	11.92%	11.92%	14.54%	17.15%	19.77%	22.38%	25.00%
EBIT(1-t)	\$ 5,067	\$ 6,197	\$ 7,575	\$ 9,255	\$ 11,301	\$ 12,899	\$ 14,149	\$ 14,891	\$ 15,012	\$ 14,467
- Reinvestment	\$ 1,158	\$ 1,448	\$ 1,810	\$ 2,263	\$ 2,828	\$ 2,896	\$ 2,720	\$ 2,261	\$ 1,525	\$ 567
FCFF	\$ 3,908	\$ 4,749	\$ 5,765	\$ 6,992	\$ 8,473	\$ 10,002	\$ 11,429	\$ 12,630	\$ 13,486	\$ 13,900

Term yr
 EBIT (1-t) \$14,816
 - Reinv 4,463
 FCFF 10,353

Operating assets \$137,386
 + Cash 9330
 - Debt 10068
 + Equity investments 2,087
 + Alipay provision 3,000
 + IPO Proceeds (est) 20,000
 - Options 696
 Value of equity 161,039
 Value per share \$65.98

Cost of capital = $8.90\% (.943) + 3.00\% (.057) = 8.56\%$

Cost of capital decreases to 8% from years 6-10

Cost of Equity 8.90%

Cost of Debt 4% (1-.25) = 3.00%

Weights
 E = 94.3% D = 5.7%

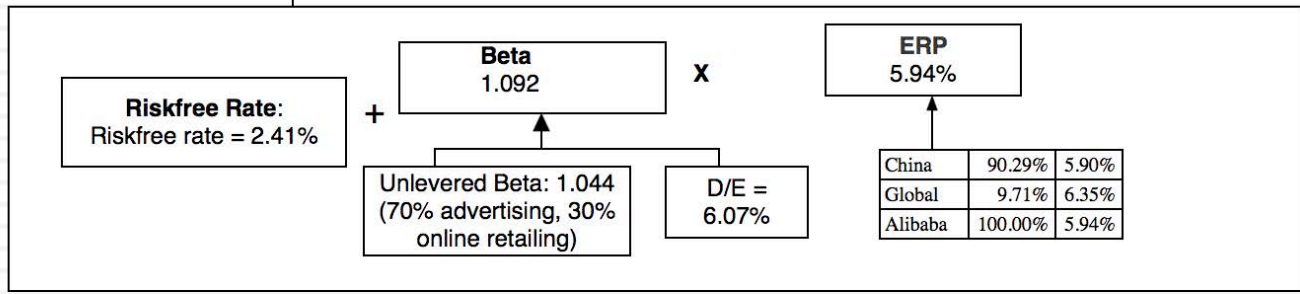

Two days after this valuation, the company (and its bankers) valued itself at about \$155 billion and the shares at \$63 apiece. The offering price was raised to \$69 and the opening price was \$93/share.

II. Mature Companies in transition..

- Mature companies are generally the easiest group to value. They have long, established histories that can be mined for inputs. They have investment policies that are set and capital structures that are stable, thus making valuation more grounded in past data.
- However, this stability in the numbers can mask real problems at the company. The company may be set in a process, where it invests more or less than it should and does not have the right financing mix. In effect, the policies are consistent, stable and bad.
- If you expect these companies to change or as is more often the case to have change thrust upon them,

The perils of valuing mature companies...

Figure 7.1: Estimation Issues - Mature Companies

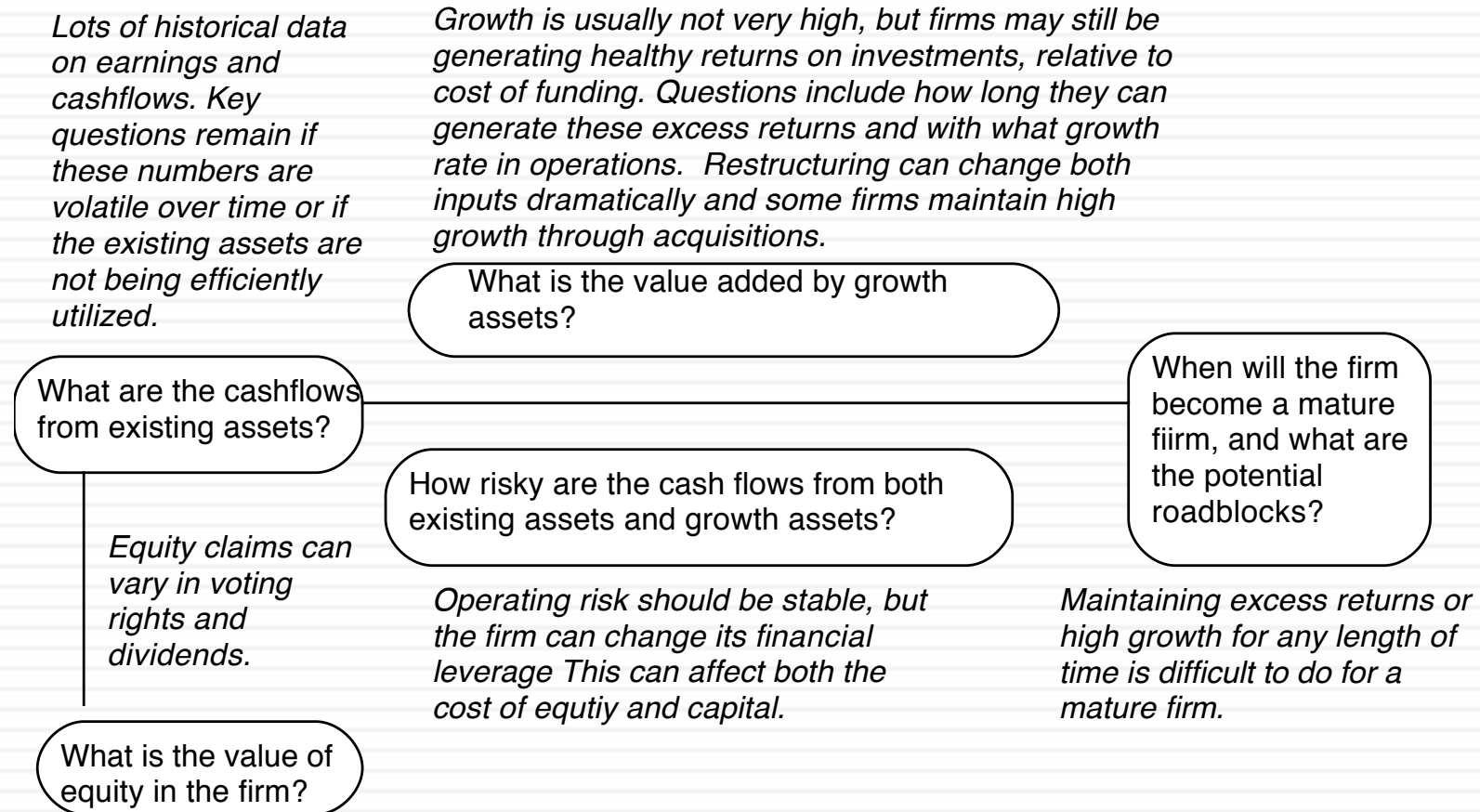

Hormel Foods: The Value of Control Changing

Hormel Foods sells packaged meat and other food products and has been in existence as a publicly traded company for almost 80 years. In 2008, the firm reported after-tax operating income of \$315 million, reflecting a compounded growth of 5% over the previous 5 years.

The Status Quo

Run by existing management, with conservative reinvestment policies (reinvestment rate = 14.34% and debt ratio = 10.4%.

Anemic growth rate and short growth period, due to reinvestment policy

Low debt ratio affects cost of capital

Year	Operating income after taxes	Expected growth rate	ROC	Reinvestment Rate	Reinvestment	FCFF	Cost of capital	Present Value
Trailing 12 months	\$315							
1	\$324	2.75%	14.34%	19.14%	\$62	\$262	6.79%	\$245
2	\$333	2.75%	14.34%	19.14%	\$64	\$269	6.79%	\$236
3	\$342	2.75%	14.34%	19.14%	\$65	\$276	6.79%	\$227
Beyond	\$350	2.35%	7.23%	32.52%	\$114	\$4,840	7.23%	\$3,974
Value of operating assets								\$4,682
(Add) Cash								\$155
(Subtract) Debt								\$491
(Subtract) Management Options								\$53
Value of equity in common stock								\$4,293
Value per share								\$31.91

New and better management

More aggressive reinvestment which increases the reinvestment rate (to 40%) and length of growth (to 5 years), and higher debt ratio (20%).

Operating Restructuring ①

Expected growth rate = $ROC \times \text{Reinvestment Rate}$
 Expected growth rate (status quo) = $14.34\% \times 19.14\% = 2.75\%$
 Expected growth rate (optimal) = $14.00\% \times 40\% = 5.60\%$
 ROC drops, reinvestment rises and growth goes up.

Financial restructuring ②

Cost of capital = Cost of equity (1-Debt ratio) + Cost of debt (Debt ratio)
 Status quo = $7.33\% (1-.104) + 3.60\% (1-.40) (.104) = 6.79\%$
 Optimal = $7.75\% (1-.20) + 3.60\% (1-.40) (.20) = 6.63\%$
 Cost of equity rises but cost of capital drops.

Year	Operating income after taxes	Expected growth rate	ROC	Reinvestment Rate	Reinvestment	FCFF	Cost of capital	Present Value
Trailing 12 months	\$315							
1	\$333	5.60%	14.00%	40.00%	\$133	\$200	6.63%	\$187
2	\$351	5.60%	14.00%	40.00%	\$141	\$211	6.63%	\$185
3	\$371	5.60%	14.00%	40.00%	\$148	\$223	6.63%	\$184
4	\$392	5.60%	14.00%	40.00%	\$260	\$235	6.63%	\$182
5	\$414	5.60%	14.00%	40.00%	\$223	\$248	6.63%	\$180
Beyond	\$423	2.35%	6.74%	34.87%	\$148	\$6,282	6.74%	\$4,557
Value of operating assets								\$5,475
(Add) Cash								\$155
(Subtract) Debt								\$491
(Subtract) Management Options								\$53
Value of equity in common stock								\$5,085
Value per share								\$37.80

Aswath Damodaran

Probability of management change = 10%
 Expected value = $\$31.91 (.90) + \$37.80 (.10) = \$32.50$

③

④

Lesson 1: Cost cutting and increased efficiency are easier accomplished on paper than in practice...

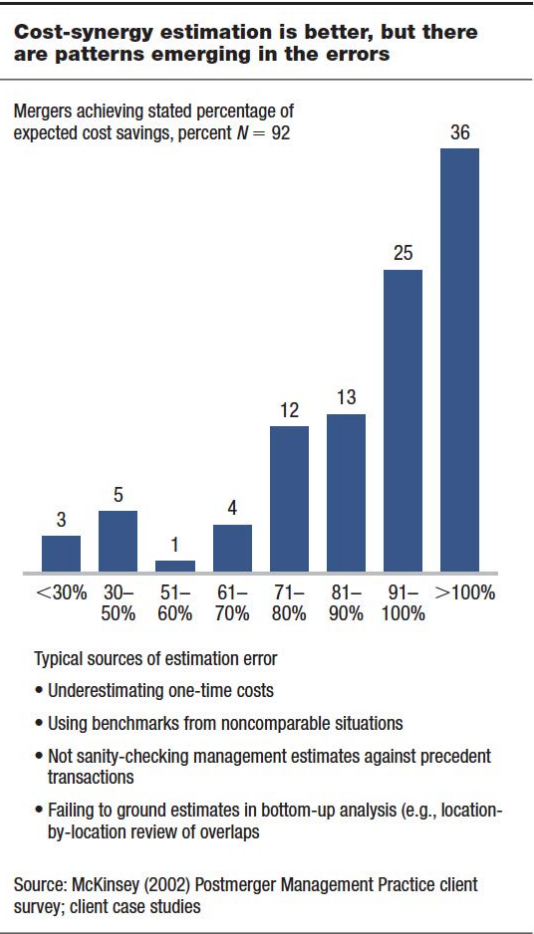

Lesson 2: Increasing growth is not always an option (or at least not a good option)

**Modes of organic growth vary in value creation intensity—
consumer goods industry**

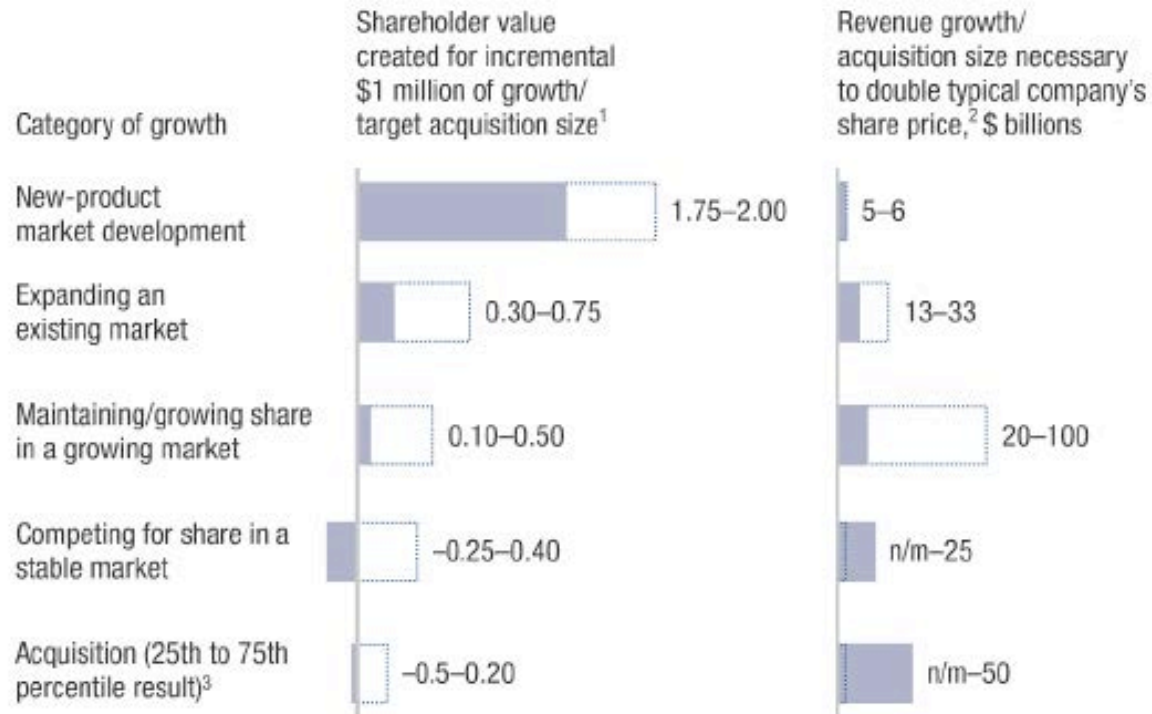

Lesson 3: Financial leverage is a double-edged sword..

Exhibit 7.1: Optimal Financing Mix: Hormel Foods in January 2009

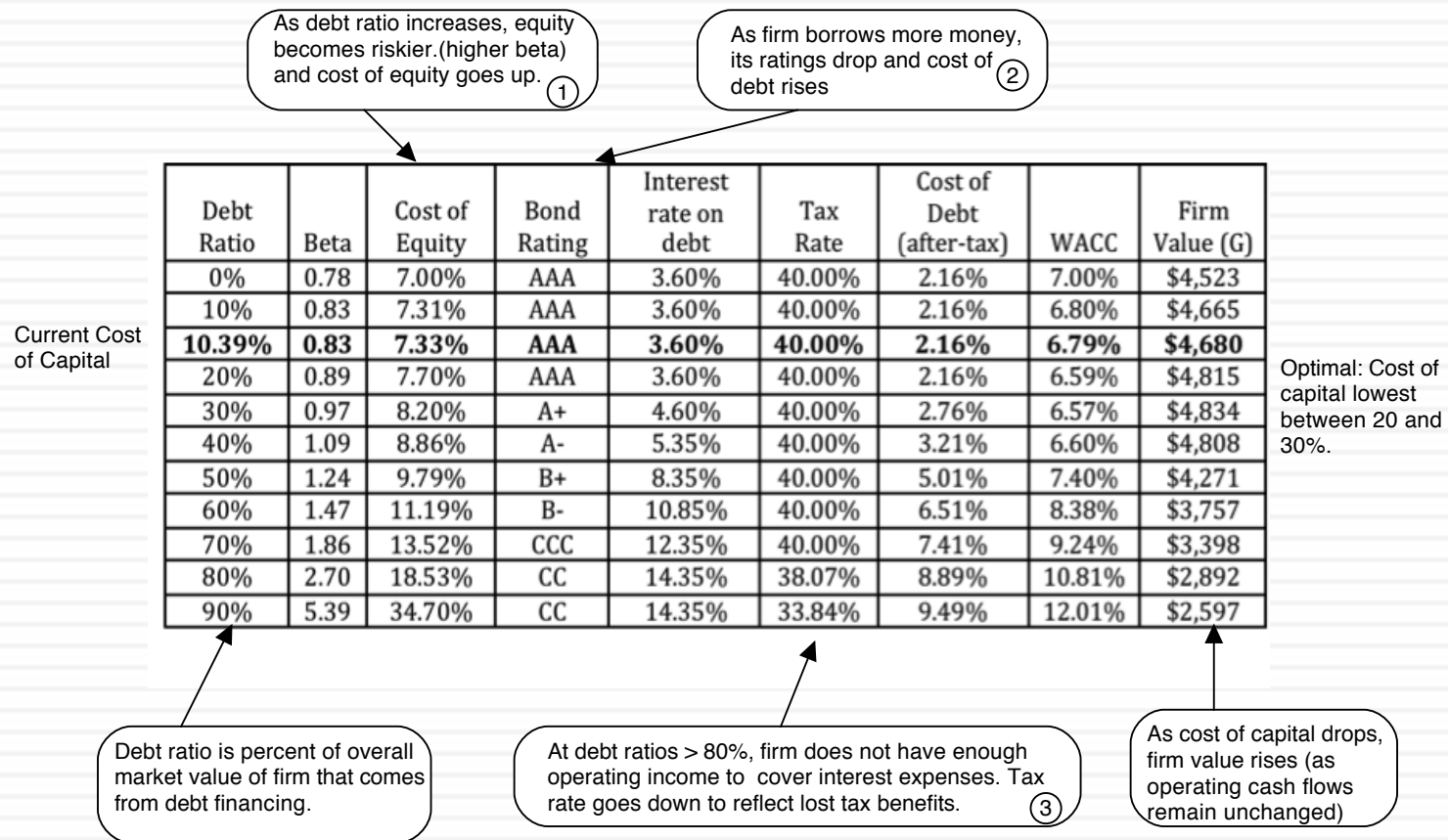

III. Dealing with decline and distress...

Historical data often reflects flat or declining revenues and falling margins. Investments often earn less than the cost of capital.

Growth can be negative, as firm sheds assets and shrinks. As less profitable assets are shed, the firm's remaining assets may improve in quality.

What is the value added by growth assets?

What are the cashflows from existing assets?

Underfunded pension obligations and litigation claims can lower value of equity. Liquidation preferences can affect value of equity

What is the value of equity in the firm?

How risky are the cash flows from both existing assets and growth assets?

Depending upon the risk of the assets being divested and the use of the proceeds from the divestiture (to pay dividends or retire debt), the risk in both the firm and its equity can change.

When will the firm become a mature firm, and what are the potential roadblocks?

There is a real chance, especially with high financial leverage, that the firm will not make it. If it is expected to survive as a going concern, it will be as a much smaller entity.

Dealing with the “downside” of Distress

- A DCF valuation values a firm as a going concern. If there is a significant likelihood of the firm failing before it reaches stable growth and if the assets will then be sold for a value less than the present value of the expected cashflows (a distress sale value), DCF valuations will understate the value of the firm.
- Value of Equity= DCF value of equity (1 - Probability of distress) + Distress sale value of equity (Probability of distress)
- There are three ways in which we can estimate the probability of distress:
 - Use the bond rating to estimate the cumulative probability of distress over 10 years
 - Estimate the probability of distress with a probit
 - Estimate the probability of distress by looking at market value of bonds..
- The distress sale value of equity is usually best estimated as a percent of book value (and this value will be lower if the economy is doing badly and there are other firms in the same business also in distress).

Current Revenue
\$ 4,390

Current Margin:
4.76%

EBIT
\$ 209m

Reinvestment:
Capital expenditures include cost of new casinos and working capital

Extended reinvestment break, due to investment in past

Industry average

Expected Margin:
-> 17%

Stable Growth
Stable Revenue Growth: 3%
Stable Operating Margin: 17%
Stable ROC=10%
Reinvest 30% of EBIT(1-t)

Terminal Value = $758 \cdot (.0743 \cdot .03)$
= \$ 17,129

Value of Op Assets \$ 9,793
+ Cash & Non-op \$ 3,040
= Value of Firm \$ 12,833
- Value of Debt \$ 7,565
= Value of Equity \$ 5,268

Value per share \$ 8.12

Revenues	\$4,434	\$4,523	\$5,427	\$6,513	\$7,815	\$8,206	\$8,616	\$9,047	\$9,499	\$9,974	
Oper margin	5.81%	6.86%	7.90%	8.95%	10%	11.40%	12.80%	14.20%	15.60%	17%	
EBIT	\$258	\$310	\$429	\$583	\$782	\$935	\$1,103	\$1,285	\$1,482	\$1,696	
Tax rate	26.0%	26.0%	26.0%	26.0%	26.0%	28.4%	30.8%	33.2%	35.6%	38.00%	
EBIT * (1 - t)	\$191	\$229	\$317	\$431	\$578	\$670	\$763	\$858	\$954	\$1,051	
- Reinvestment	-\$19	-\$11	\$0	\$22	\$58	\$67	\$153	\$215	\$286	\$350	
FCFF	\$210	\$241	\$317	\$410	\$520	\$603	\$611	\$644	\$668	\$701	
		1	2	3	4	5	6	7	8	9	10
Beta	3.14	3.14	3.14	3.14	3.14	2.75	2.36	1.97	1.59	1.20	
Cost of equity	21.82%	21.82%	21.82%	21.82%	21.82%	19.50%	17.17%	14.85%	12.52%	10.20%	
Cost of debt	9%	9%	9%	9%	9%	8.70%	8.40%	8.10%	7.80%	7.50%	
Debt/ratio	73.50%	73.50%	73.50%	73.50%	73.50%	68.80%	64.10%	59.40%	54.70%	50.00%	
Cost of capital	9.88%	9.88%	9.88%	9.88%	9.88%	9.79%	9.50%	9.01%	8.32%	7.43%	

Term. Year
\$10,273
17%
\$ 1,746
38%
\$1,083
\$ 325
\$758

Forever

Cost of Equity
21.82%

Cost of Debt
3%+6%= 9%
9% (1-.38)=5.58%

Weights
Debt= 73.5% ->50%

Riskfree Rate:
T. Bond rate = 3%

+

Beta
3.14-> 1.20

X

Risk Premium
6%

Aswath Damodaran

Casino
1.15

Current
D/E: 277%

Base Equity
Premium

Country Risk
Premium

Las Vegas Sands
February 2009
Trading @ \$4.25

Adjusting the value of LVS for distress..

- In February 2009, LVS was rated B+ by S&P. Historically, 28.25% of B+ rated bonds default within 10 years. LVS has a 6.375% bond, maturing in February 2015 (7 years), trading at \$529. If we discount the expected cash flows on the bond at the riskfree rate, we can back out the probability of distress from the bond price:

$$529 = \sum_{t=1}^{t=7} \frac{63.75(1 - \pi_{\text{Distress}})^t}{(1.03)^t} + \frac{1000(1 - \pi_{\text{Distress}})^7}{(1.03)^7}$$

- Solving for the probability of bankruptcy, we get:
- π_{Distress} = Annual probability of default = 13.54%
 - ▣ Cumulative probability of surviving 10 years = $(1 - .1354)^{10} = 23.34\%$
 - ▣ Cumulative probability of distress over 10 years = $1 - .2334 = .7666$ or 76.66%
- If LVS is becomes distressed:
 - ▣ Expected distress sale proceeds = \$2,769 million < Face value of debt
 - ▣ Expected equity value/share = \$0.00
- Expected value per share = $\$8.12 (1 - .7666) + \$0.00 (.7666) = \$1.92$

The “sunny” side of distress: Equity as a call option to liquidate the firm

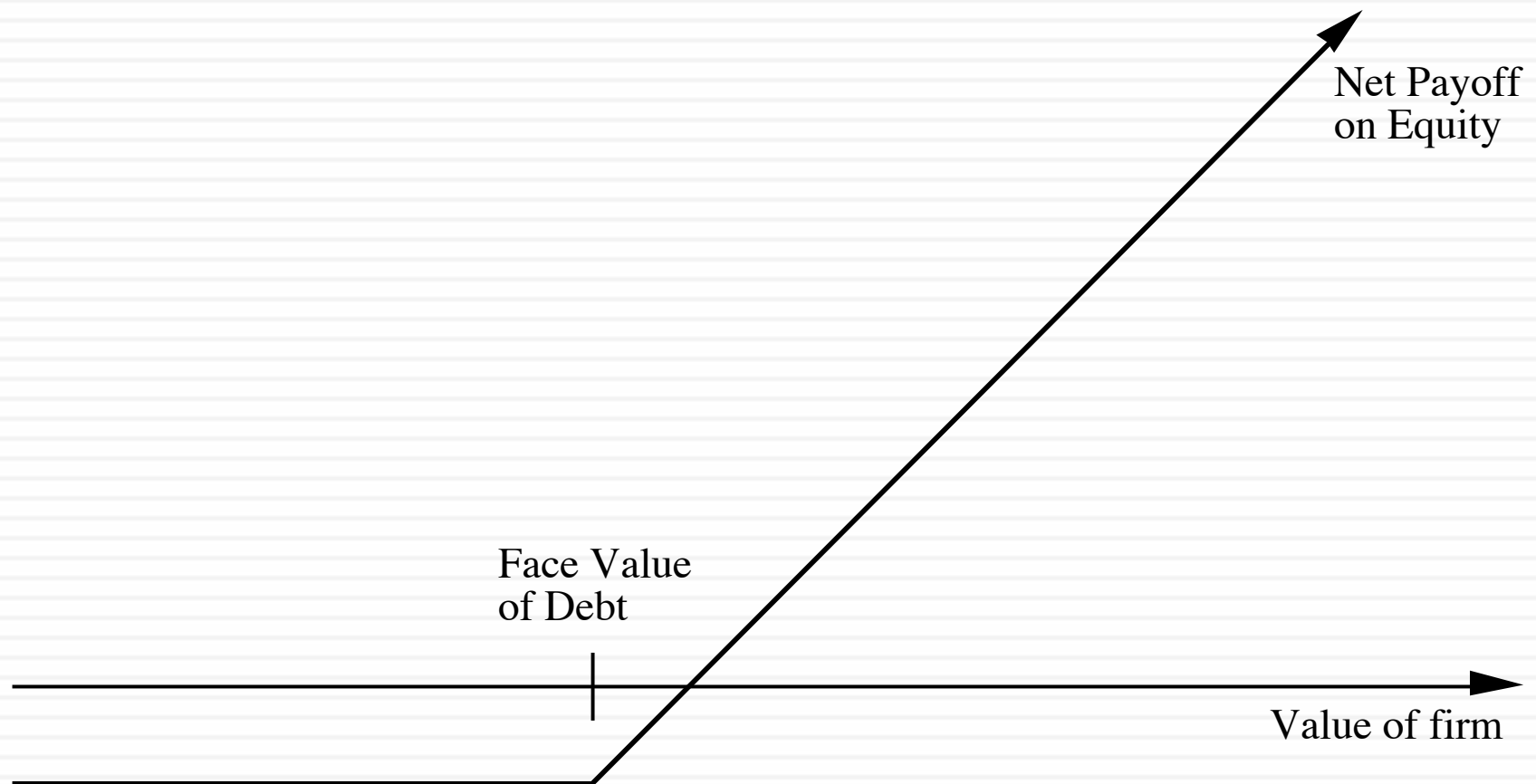

Application to valuation: A simple example

- Assume that you have a firm whose assets are currently valued at \$100 million and that the standard deviation in this asset value is 40%.
- Further, assume that the face value of debt is \$80 million (It is zero coupon debt with 10 years left to maturity).
- If the ten-year treasury bond rate is 10%,
 - ▣ how much is the equity worth?
 - ▣ What should the interest rate on debt be?

Firm value drops..

- Assume now that a catastrophe wipes out half the value of this firm (the value drops to \$ 50 million), while the face value of the debt remains at \$ 80 million.
- The inputs
 - Value of the underlying asset = S = Value of the firm = \$ 50 million
 - All the other inputs remain unchanged
- The output
 - Based upon these inputs, the Black-Scholes model provides the following value for the call:
 - $d1 = 1.0515$ $N(d1) = 0.8534$
 - $d2 = -0.2135$ $N(d2) = 0.4155$
 - Value of the call = $50 (0.8534) - 80 \exp^{(-0.10)(10)} (0.4155) = \30.44 million
 - Value of the bond = $\$50 - \$30.44 = \$19.56$ million

Equity value persists .. As firm value declines..

Value of Equity as Firm Value Changes

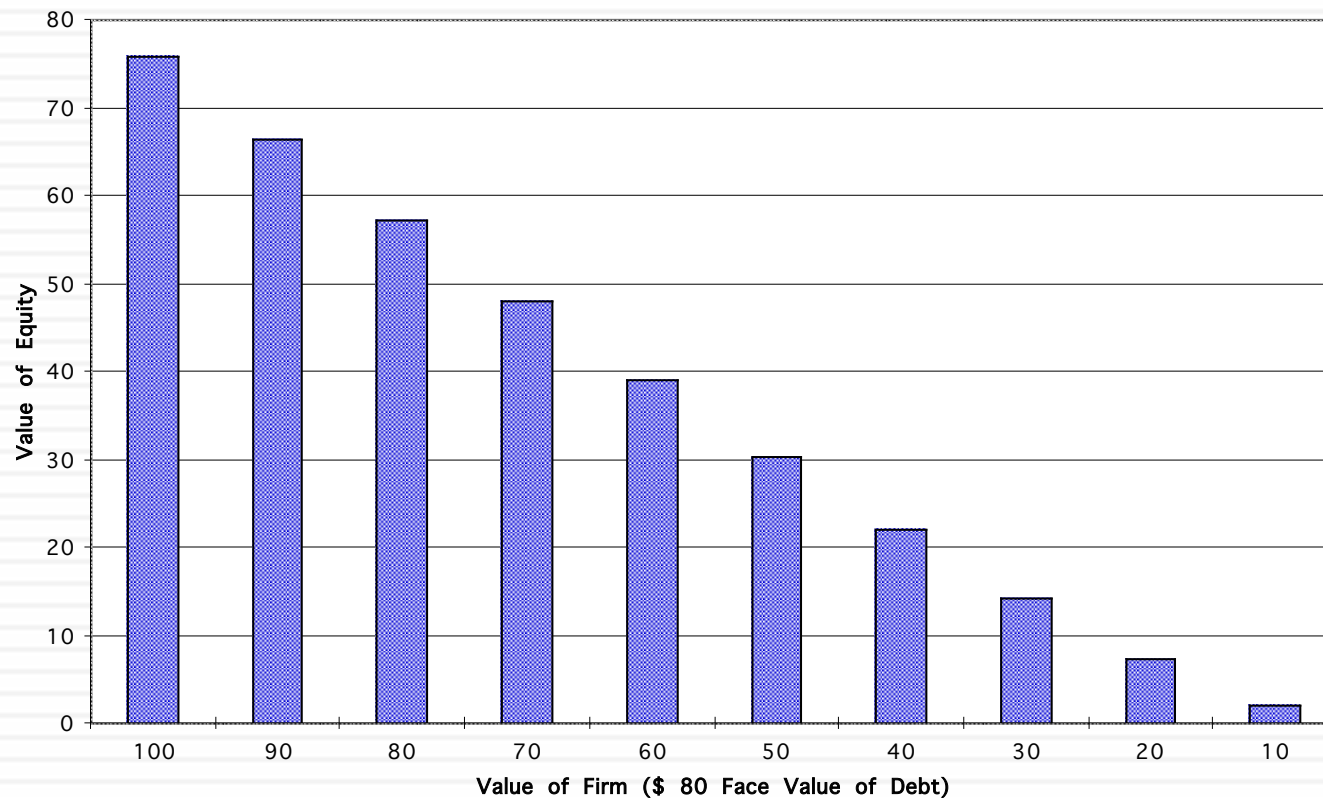

IV. Valuing Financial Service Companies

Existing assets are usually financial assets or loans, often marked to market. Earnings do not provide much information on underlying risk.

Defining capital expenditures and working capital is a challenge. Growth can be strongly influenced by regulatory limits and constraints. Both the amount of new investments and the returns on these investments can change with regulatory changes.

What are the cashflows from existing assets?

What is the value added by growth assets?

When will the firm become a mature firm, and what are the potential roadblocks?

Preferred stock is a significant source of capital.

How risky are the cash flows from both existing assets and growth assets?

What is the value of equity in the firm?

For financial service firms, debt is raw material rather than a source of capital. It is not only tough to define but if defined broadly can result in high financial leverage, magnifying the impact of small operating risk changes on equity risk.

In addition to all the normal constraints, financial service firms also have to worry about maintaining capital ratios that are acceptable to regulators. If they do not, they can be taken over and shut down.

2b. Goldman Sachs: August 2008

Rationale for model

Why dividends? Because FCFE cannot be estimated

Why 3-stage? Because the firm is behaving (reinvesting, growing) like a firm with potential.

Left return on equity at 2008 levels. well below 16% in 2007 and 20% in 2004-2006.

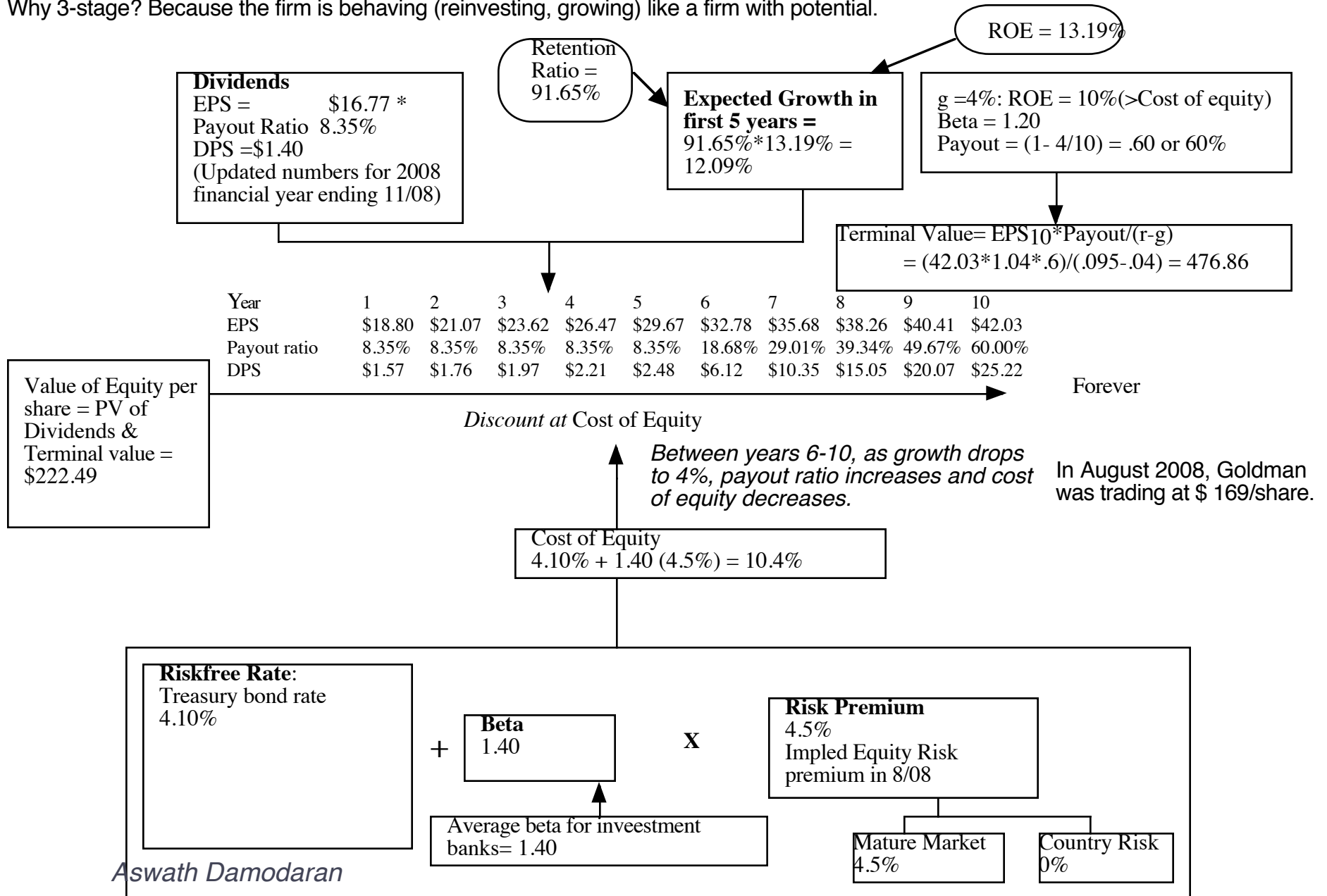

Lesson 1: Financial service companies are opaque...

- With financial service firms, we enter into a Faustian bargain. They tell us very little about the quality of their assets (loans, for a bank, for instance are not broken down by default risk status) but we accept that in return for assets being marked to market (by accountants who presumably have access to the information that we don't have).
- In addition, estimating cash flows for a financial service firm is difficult to do. So, we trust financial service firms to pay out their cash flows as dividends. Hence, the use of the dividend discount model.

Lesson 2: For financial service companies, book value matters...

- The book value of assets and equity is mostly irrelevant when valuing non-financial service companies. After all, the book value of equity is a historical figure and can be nonsensical. (The book value of equity can be negative and is so for more than a 1000 publicly traded US companies)
- With financial service firms, book value of equity is relevant for two reasons:
 - Since financial service firms mark to market, the book value is more likely to reflect what the firms own right now (rather than a historical value)
 - The regulatory capital ratios are based on book equity. Thus, a bank with negative or even low book equity will be shut down by the regulators.
- From a valuation perspective, it therefore makes sense to pay heed to book value. In fact, you can argue that reinvestment for a bank is the amount that it needs to add to book equity to sustain its growth ambitions and safety requirements:
 - $FCFE = \text{Net Income} - \text{Reinvestment in regulatory capital (book equity)}$

2d. Deutsche Bank: March 2009

Last 2 years

	2007	2008
Net Income	3,954 m	-3,855m
Dividends	2,146 m	285 m
Risk adjusted assets =		312,882m
Book Equity =		31,914 m
Regulatory Capital =		

Normalized
Net Income
for base year
3,000 m
Normalized
ROE = 9.4%

Expected
growth in
asset base
4%

Target capital
ratio 10%

Target ROE
10.2%

Stable Growth
g = 3%; Beta = 1.00
Cost of equity = 10.20%
Return on equity = 10.20%;
Reinvestment Rate = g/ROE
= $3/10.20\% = 29.41\%$

Cashflows

	1	2	3	4	5
Asset Base	325,398 €	338,414 €	351,950 €	366,028 €	380,669 €
Capital ratio	10.16%	10.12%	10.08%	10.04%	10.00%
Regulatory Capital	33,060 €	34,247 €	35,477 €	36,749 €	38,067 €
Change in capital	1,146 €	1,187 €	1,229 €	1,273 €	1,318 €
ROE	9.56%	9.72%	9.88%	10.04%	10.20%
Net Income	3,161 €	3,329 €	3,505 €	3,690 €	3,883 €
-Reinvestment	1,146 €	1,187 €	1,229 €	1,273 €	1,318 €
FCFE	2,014 €	2,142 €	2,276 €	2,417 €	2,565 €

Terminal Value₅ = $2,823 / (.102 - .03) = 39,209$ m

3,999
1,176
2,823

PV of CF = 31,383 m
/ # shares 581.85
Value/Share 53.94 €

Discount at Cost of equity = $3.60\% + 1.162 * 6\% + -0.60\% = 11.172\%$

In March 2009
Deutsche Bank price = 48
Euros/share (down from 89
Euros in early 2008)

Riskfree Rate:
Euro Riskfree Rate =
3.6%

+

Beta
1.162

X

Mature market
premium
6%

+

Region	Lambda	CRP
Western Europe	0.68	0.00%
United States	0.42	0.00%
Latin America	0.01	4.50%
Africa & Middle East	0.01	7.00%
Asia	0.11	3.50%
Eastern Europe	0.04	3.00%
Deutsche Bank		0.60%

Beta for commercial &
Investment banking

Aswath Damodaran

V. Valuing cyclical and commodity companies

Company growth often comes from movements in the economic cycle, for cyclical firms, or commodity prices, for commodity companies.

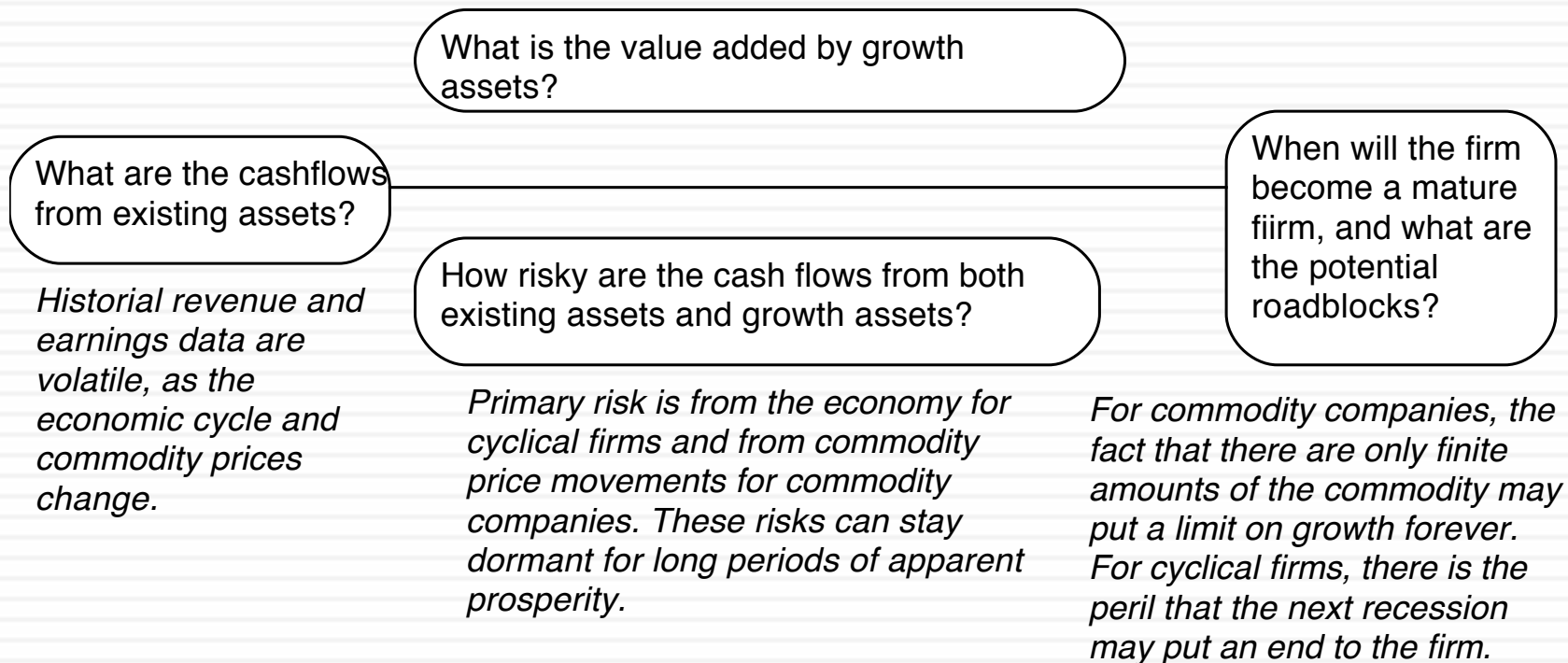

Valuing a Cyclical Company - Toyota in Early 2009

Year	Revenues	Operating Incol	EBITDA	Operating Marg
FY1 1992	¥10,163,380	¥218,511	¥218,511	2.15%
FY1 1993	¥10,210,750	¥181,897	¥181,897	1.78%
FY1 1994	¥9,362,732	¥136,226	¥136,226	1.45%
FY1 1995	¥8,120,975	¥255,719	¥255,719	3.15%
FY1 1996	¥10,718,740	¥348,069	¥348,069	3.25%
FY1 1997	¥12,243,830	¥665,110	¥665,110	5.43%
FY1 1998	¥11,678,400	¥779,800	¥1,382,950	6.68%
FY1 1999	¥12,749,010	¥774,947	¥1,415,997	6.08%
FY1 2000	¥12,879,560	¥775,982	¥1,430,982	6.02%
FY1 2001	¥13,424,420	¥870,131	¥1,542,631	6.48%
FY1 2002	¥15,106,300	¥1,123,475	¥1,822,975	7.44%
FY1 2003	¥16,054,290	¥1,363,680	¥2,101,780	8.49%
FY1 2004	¥17,294,760	¥1,666,894	¥2,454,994	9.64%
FY1 2005	¥18,551,530	¥1,672,187	¥2,447,987	9.01%
FY1 2006	¥21,036,910	¥1,878,342	¥2,769,742	8.93%
FY1 2007	¥23,948,090	¥2,238,683	¥3,185,683	9.35%
FY1 2008	¥26,289,240	¥2,270,375	¥3,312,775	8.64%
FY 2009 (Estin	¥22,661,325	¥267,904	¥1,310,304	1.18%
		¥1,306,867		7.33%

Normalized Earnings ①

As a cyclical company, Toyota's earnings have been volatile and 2009 earnings reflect the troubled global economy. We will assume that when economic growth returns, the operating margin for Toyota will revert back to the historical average.

Normalized Operating Income = Revenues in 2009 * Average Operating Margin (98--09)
 = 22661 * .0733 = 1660.7 billion yen

In early 2009, Toyota Motors had the highest market share in the sector. However, the global economic recession in 2008-09 had pulled earnings down.

Normalized Return on capital and Reinvestment ②

Once earnings bounce back to normal, we assume that Toyota will be able to earn a return on capital equal to its cost of capital (5.09%). This is a sector, where earning excess returns has proved to be difficult even for the best of firms.

To sustain a 1.5% growth rate, the reinvestment rate has to be:
 Reinvestment rate = 1.5%/5.09%
 = 29.46%

Operating Assets	19,640
+ Cash	2,288
+ Non-operating assets	6,845
- Debt	11,862
- Minority Interests	583
Value of Equity	
/ No of shares	/3,448
Value per share	¥4735

$$\text{Value of operating assets} = \frac{1660.7 (1.015) (1 - .407) (1 - .2946)}{(.0509 - .015)} = 19,640 \text{ billion}$$

Normalized Cost of capital ③

The cost of capital is computed using the average beta of automobile companies (1.10), and Toyota's cost of debt (3.25%) and debt ratio (52.9% debt ratio). We use the Japanese marginal tax rate of 40.7% for computing both the after-tax cost of debt and the after-tax operating income

$$\text{Cost of capital} = (1.10 * 0.0509 * (1 - 0.407)) + 3.25\% * (1 - 0.407) * (0.529) = 5.09\%$$

Stable Growth ④

Once earnings are normalized, we assume that Toyota, as the largest market-share company, will be able to maintain only stable growth (1.5% in Yen terms)

Valuing a commodity company - Exxon in Early 2009

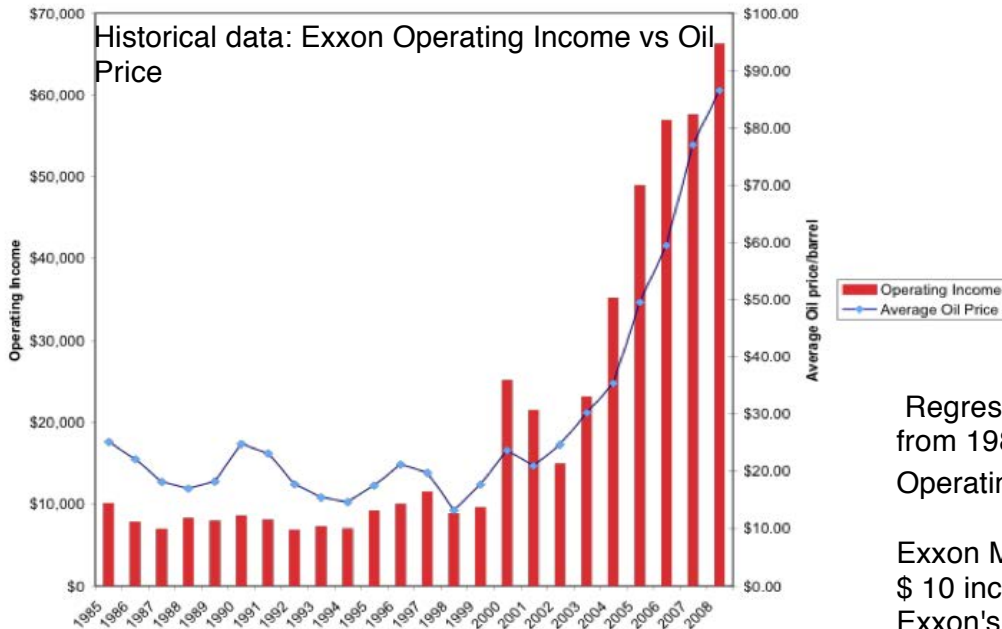

Regressing Exxon's operating income against the oil price per barrel from 1985-2008:

$$\text{Operating Income} = -6,395 + 911.32 (\text{Average Oil Price}) \quad R^2 = 90.2\%$$

(2.95) (14.59)

Exxon Mobil's operating income increases about \$9.11 billion for every \$ 10 increase in the price per barrel of oil and 90% of the variation in Exxon's earnings over time comes from movements in oil prices.

Estimate normalized income based on current oil price ①

At the time of the valuation, the oil price was \$ 45 a barrel. Exxon's operating income based on this price is

$$\text{Normalized Operating Income} = -6,395 + 911.32 (\$45) = \$34,614$$

Estimate return on capital and reinvestment rate based on normalized income ②

This operating income translates into a return on capital of approximately 21% and a reinvestment rate of 9.52%, based upon a 2% growth rate.

$$\text{Reinvestment Rate} = g / \text{ROC} = 2 / 21\% = 9.52\%$$

$$\text{Value of operating assets} = \frac{34,614(1 - .38)(1 - .0952)}{(.0818 - .02)} = \$320,472 \text{ million}$$

Exxon's cost of capital ④

Exxon has been a predominantly equity funded company, and is expected to remain so, with a debt ratio of only 2.85%. Its cost of equity is 8.35% (based on a beta of 0.90) and its pre-tax cost of debt is 3.75% (given AAA rating). The marginal tax rate is 38%.

$$\text{Cost of capital} = 8.35\% (0.9715) + 3.75\% (1 - .38) (.0285) = 8.18\%$$

Expected growth in operating income ③

Since Exxon Mobile is the largest oil company in the world, we will assume an expected growth of only 2% in perpetuity.

Lesson 1: With “macro” companies, it is easy to get lost in “macro” assumptions...

- With cyclical and commodity companies, it is undeniable that the value you arrive at will be affected by your views on the economy or the price of the commodity.
- Consequently, you will feel the urge to take a stand on these macro variables and build them into your valuation. Doing so, though, will create valuations that are jointly impacted by your views on macro variables and your views on the company, and it is difficult to separate the two.
- The best (though not easiest) thing to do is to separate your macro views from your micro views. Use current market based numbers for your valuation, but then provide a separate assessment of what you think about those market numbers.

Lesson 2: Use probabilistic tools to assess value as a function of macro variables...

- If there is a key macro variable affecting the value of your company that you are uncertain about (and who is not), why not quantify the uncertainty in a distribution (rather than a single price) and use that distribution in your valuation.
- That is exactly what you do in a Monte Carlo simulation, where you allow one or more variables to be distributions and compute a distribution of values for the company.
- With a simulation, you get not only everything you would get in a standard valuation (an estimated value for your company) but you will get additional output (on the variation in that value and the likelihood that your firm is under or over valued)

Exxon Mobil Valuation: Simulation

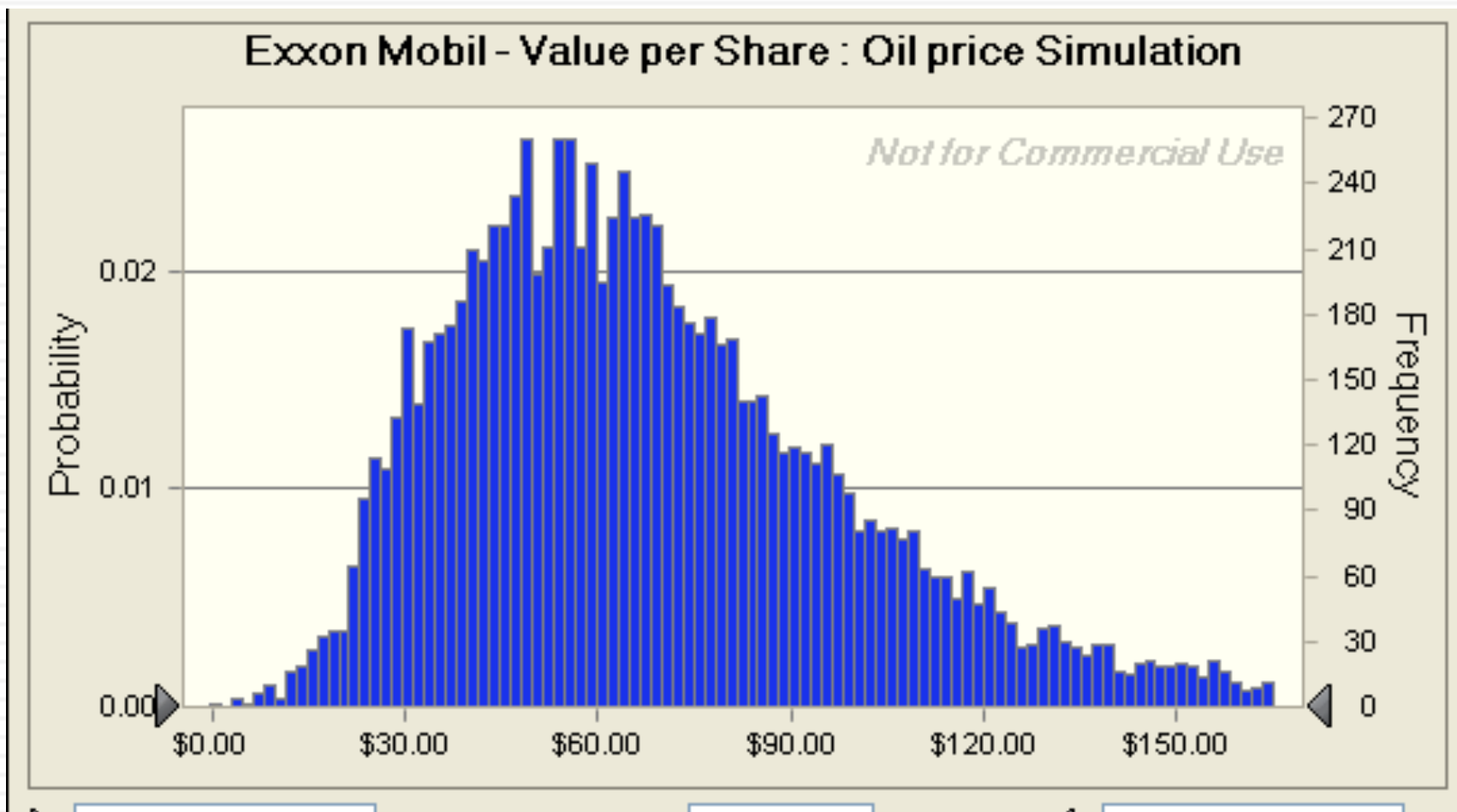

The optionality in commodities: Undeveloped reserves as an option

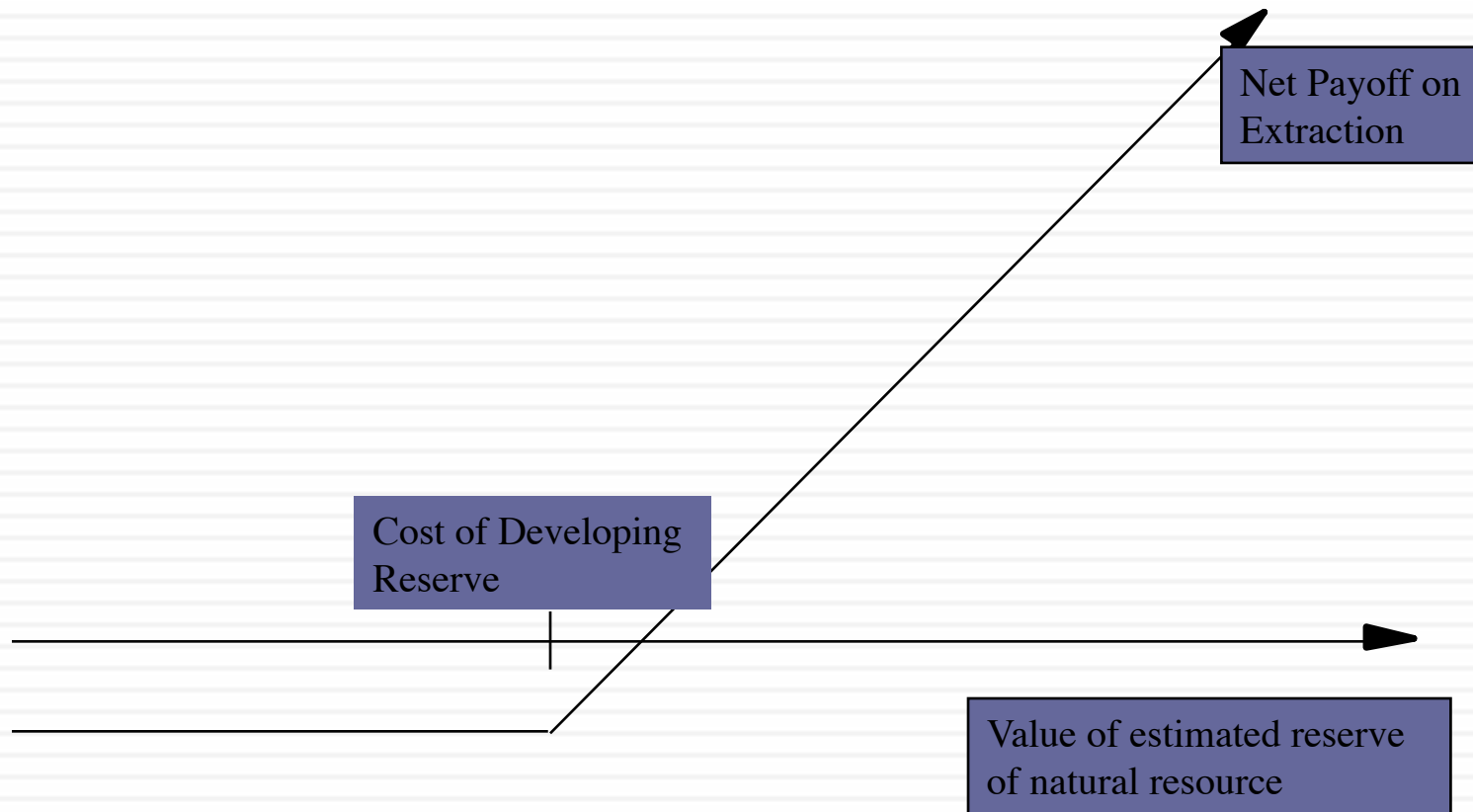

Valuing Gulf Oil

- Gulf Oil was the target of a takeover in early 1984 at \$70 per share (It had 165.30 million shares outstanding, and total debt of \$9.9 billion).
 - It had estimated reserves of 3038 million barrels of oil and the average cost of developing these reserves was estimated to be \$10 a barrel in present value dollars (The development lag is approximately two years).
 - The average relinquishment life of the reserves is 12 years.
 - The price of oil was \$22.38 per barrel, and the production cost, taxes and royalties were estimated at \$7 per barrel.
 - The bond rate at the time of the analysis was 9.00%.
 - Gulf was expected to have net production revenues each year of approximately 5% of the value of the developed reserves. The variance in oil prices is 0.03.

Valuing Undeveloped Reserves

- Inputs for valuing undeveloped reserves
 - Value of underlying asset = Value of estimated reserves discounted back for period of development lag = $3038 * (\$ 22.38 - \$7) / 1.05^2 = \$42,380.44$
 - Exercise price = Estimated development cost of reserves = $3038 * \$10 = \$30,380$ million
 - Time to expiration = Average length of relinquishment option = 12 years
 - Variance in value of asset = Variance in oil prices = 0.03
 - Riskless interest rate = 9%
 - Dividend yield = Net production revenue/ Value of developed reserves = 5%
- Based upon these inputs, the Black-Scholes model provides the following value for the call:
 - $d1 = 1.6548$ $N(d1) = 0.9510$
 - $d2 = 1.0548$ $N(d2) = 0.8542$
- Call Value = $42,380.44 \exp^{(-0.05)(12)} (0.9510) - 30,380 (\exp^{(-0.09)(12)} (0.8542)) = \$13,306$ million

The composite value...

- In addition, Gulf Oil had free cashflows to the firm from its oil and gas production of \$915 million from already developed reserves and these cashflows are likely to continue for ten years (the remaining lifetime of developed reserves).
- The present value of these developed reserves, discounted at the weighted average cost of capital of 12.5%, yields:
 - ▣ Value of already developed reserves = $915 (1 - 1.125^{-10}) / .125 = \5065.83
- Adding the value of the developed and undeveloped reserves
 - ▣ Value of undeveloped reserves = \$ 13,306 million
 - ▣ Value of production in place = \$ 5,066 million
 - ▣ Total value of firm = \$ 18,372 million
 - ▣ Less Outstanding Debt = \$ 9,900 million
 - ▣ Value of Equity = \$ 8,472 million
 - ▣ Value per share = \$ 8,472 / 165.3 = \$51.25

VII. Valuing Companies across the ownership cycle

Reported income and balance sheet are heavily affected by tax considerations rather than information disclosure requirements. The line between the personal and business expenses is a fine one.

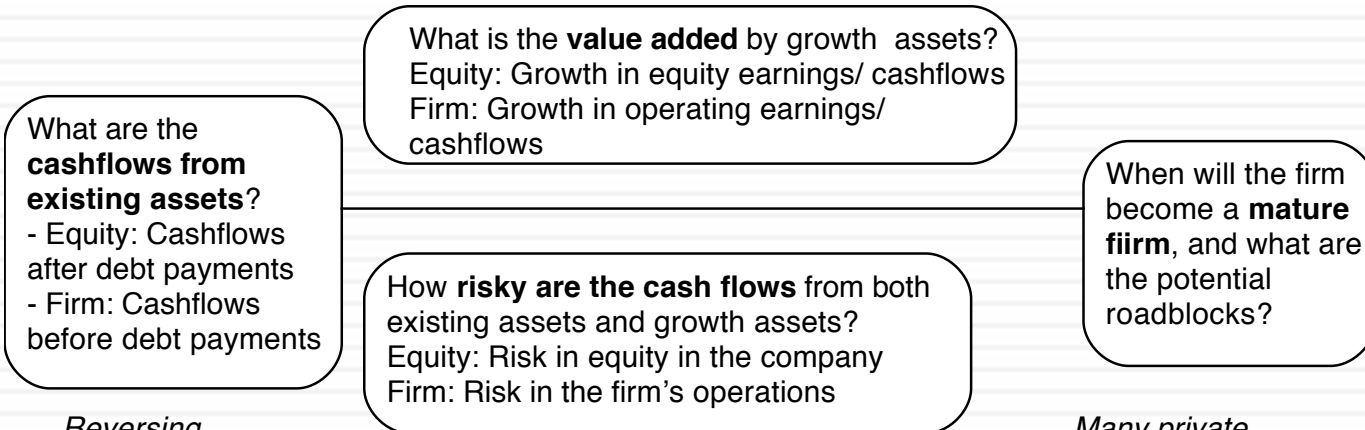

Reversing investment mistakes is difficult to do. The need for and the cost of illiquidity has to be incorporated into current

Different buyers can perceive risk differently in the same private business, largely because what they see as risk will be a function of how diversified they are. The fall back positions of using market prices to extract risk measures does not

Many private businesses are finite life enterprises, not expected to last into perpetuity

Kristin's Kandy: Valuation in March 2006

Current Cashflow to Firm
 EBIT(1-t) : 300
 - Nt CpX 100
 - Chg WC 40
 = FCFF 160
 Reinvestment Rate = 46.67%

Reinvestment Rate
 46.67%

Expected Growth in EBIT (1-t)
 $.4667 * .1364 = .0636$
6.36%

Return on Capital
 13.64%

Stable Growth
 $g = 4\%$; Beta = 3.00;
 ROC = 12.54%
 Reinvestment Rate = 31.90%

Terminal Value₅ = $289 / (.1254 - .04) = 3,403$

Firm Value: 2,571
 + Cash 125
 - Debt: 900
 = Equity 1,796
 - Illiq Discount 12.5%
 Adj Value 1,571

Year	1	2	3	4	5	Term Yr
EBIT (1-t)	\$319	\$339	\$361	\$384	\$408	425
- Reinvestment	\$149	\$158	\$168	\$179	\$191	136
=FCFF	\$170	\$181	\$193	\$205	\$218	289

Discount at Cost of Capital (WACC) = $16.26\% (.70) + 3.30\% (.30) = 12.37\%$

Cost of Equity
 16.26%

Cost of Debt
 $(4.5\% + 1.00)(1 - .40) = 3.30\%$
 Synthetic rating = A-

Weights
 E = 70% D = 30%

Riskfree Rate:
 Riskfree rate = 4.50%
 (10-year T.Bond rate)

Total Beta
 2.94

X

Risk Premium
 4.00%

+
 1/3 of risk is market risk

Adjusted for ownrer non-diversification

Market Beta: 0.98

Mature risk premium 4%

Country Risk Premium 0%

Aswath Damodaran

Unlevered Beta for Sectors: 0.78

Firm's D/E Ratio: 30/70

Lesson 1: In private businesses, risk in the eyes of the “beholder” (buyer)

Private business owner with entire wealth invested in the business

Venture capitalist, with multiple holdings in the sector.

Public company investor with diversified portfolio

Exposed to all risk in the company. Total beta measures exposure to total risk. Total Beta = Market Beta/ Correlation of firm with market

Partially diversified. Diversify away some firm specific risk but not all. Beta will fall between total and market beta.

Firm-specific risk is diversified away. Market or macro risk exposure captured in a market beta or betas.

Private Owner versus Publicly Traded Company Perceptions of Risk in an Investment

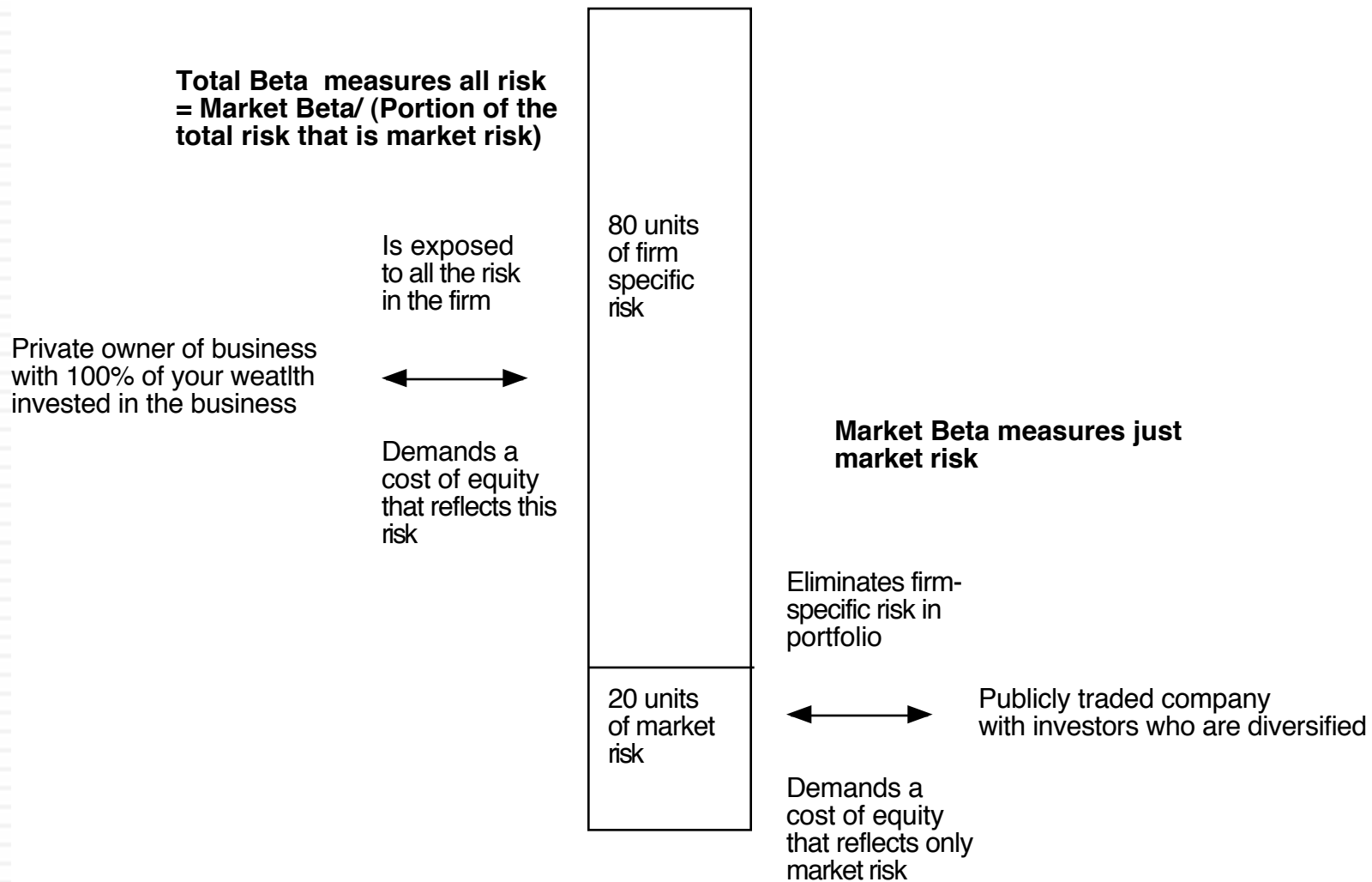

Total Risk versus Market Risk

- Adjust the beta to reflect total risk rather than market risk. This adjustment is a relatively simple one, since the R squared of the regression measures the proportion of the risk that is market risk.
 - Total Beta = Market Beta / Correlation of the sector with the market
- To estimate the beta for Kristin Kandy, we begin with the bottom-up unlevered beta of food processing companies:
 - Unlevered beta for publicly traded food processing companies = 0.78
 - Average correlation of food processing companies with market = 0.333
 - Unlevered total beta for Kristin Kandy = $0.78/0.333 = 2.34$
 - Debt to equity ratio for Kristin Kandy = $0.3/0.7$ (assumed industry average)
 - Total Beta = $2.34 (1 - (1-.40)(30/70)) = 2.94$
 - Total Cost of Equity = $4.50\% + 2.94 (4\%) = 16.26\%$

Lesson 2: With financials, trust but verify..

- Different Accounting Standards: The accounting statements for private firms are often based upon different accounting standards than public firms, which operate under much tighter constraints on what to report and when to report.
- Intermingling of personal and business expenses: In the case of private firms, some personal expenses may be reported as business expenses.
- Separating “Salaries” from “Dividends”: It is difficult to tell where salaries end and dividends begin in a private firm, since they both end up with the owner.
- The Key person issue: In some private businesses, with a personal component, the cashflows may be intertwined with the owner being part of the business.

Lesson 3: Illiquidity is a clear and present danger..

- In private company valuation, illiquidity is a constant theme. All the talk, though, seems to lead to a rule of thumb. The illiquidity discount for a private firm is between 20-30% and does not vary across private firms.
- But illiquidity should vary across:
 - Companies: Healthier and larger companies, with more liquid assets, should have smaller discounts than money-losing smaller businesses with more illiquid assets.
 - Time: Liquidity is worth more when the economy is doing badly and credit is tough to come by than when markets are booming.
 - Buyers: Liquidity is worth more to buyers who have shorter time horizons and greater cash needs than for longer term investors who don't need the cash and are willing to hold the investment.



NARRATIVE AND NUMBERS:
VALUATION AS A BRIDGE



Bridging the Gap

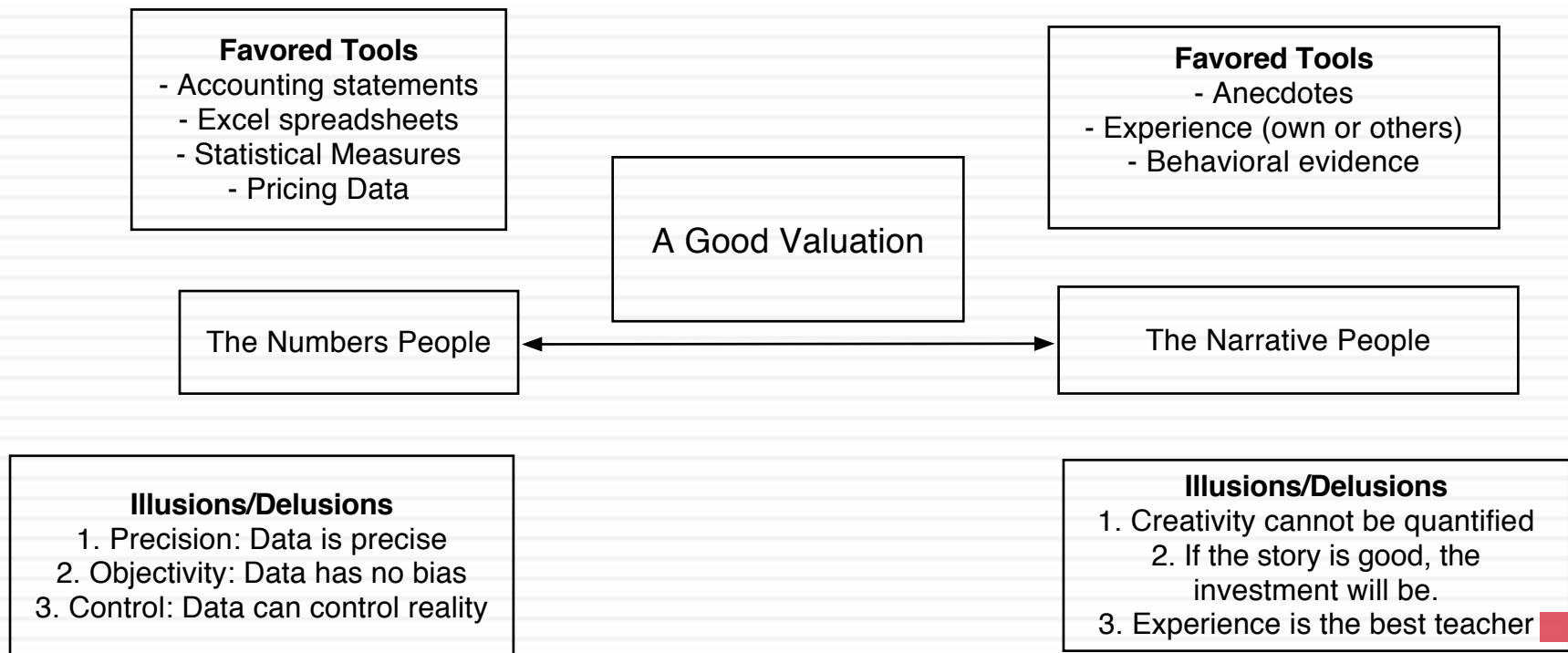

Step 1: Create a narrative



- Every valuation starts with a narrative, a story that you see unfolding for your company in the future.
- In developing this narrative, you will be making assessments of your company (its products, its management), the market or markets that you see it growing in, the competition it faces and will face and the macro environment in which it operates

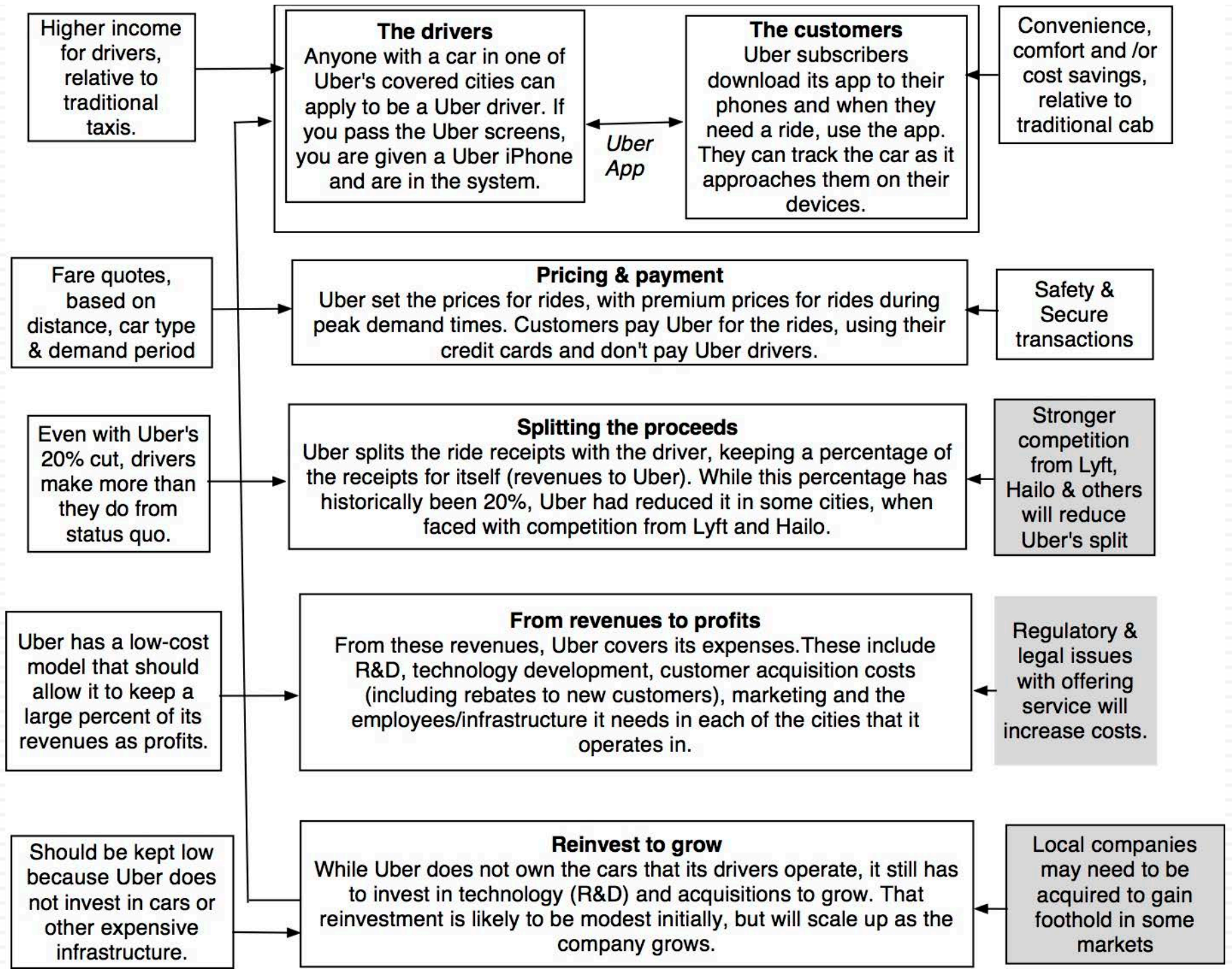

Potential Markets for Uber

<i>Potential Market</i>	<i>Market Size</i>	<i>Industry structure</i>
Taxi & Limo Market	Roughly \$100 billion (based upon city-specific estimates).	Highly splintered (top 50 companies account for 35% market share), localized and private.
Rental Car Market	Approximately \$36 billion just for the US and \$50 billion globally.	Three companies (Enterprise, Hertz and Avis) account for 60% of the overall market.
Moving Services	Approximately \$20 billion in the US (and no data is available for global).	A few large companies but none with dominant market share, with lots of localized, small movers.
Local Delivery business	Approximately \$35 billion (more guesstimate than estimate).	Historically, it has been a localized, splintered business but Amazon and Google have entered the business recently.
Mass Transit	Approximately \$60 billion for the US.	Barring a few privately owned bus companies, mostly government owned and subsidized.
Car Sharing	Approximately \$20 billion, bigger in Europe than in the US, but growing fast.	A mix of young businesses, some tech based, trying to match needs to resources.

Your narrative and counters

- *My narrative for Uber:* Uber will expand the car service market moderately, primarily in urban environments, and use its competitive advantages to get a significant but not dominant market share and maintain its profit margins.
- *Bill Gurley's counter narrative*
 - Not just car service company.: Uber is a car company, not just a car service company, and there may be a day when consumers will subscribe to a Uber service, rather than own their own cars. It could also expand into logistics, i.e., moving and transportation businesses.
 - Not just urban: Uber can create new demands for car service in parts of the country where taxis are not used (suburbia, small towns).
 - Global networking benefits: By linking with technology and credit card companies, Uber can have global networking benefits.

Step 2: Check the narrative against history, economic first principles & common sense

132

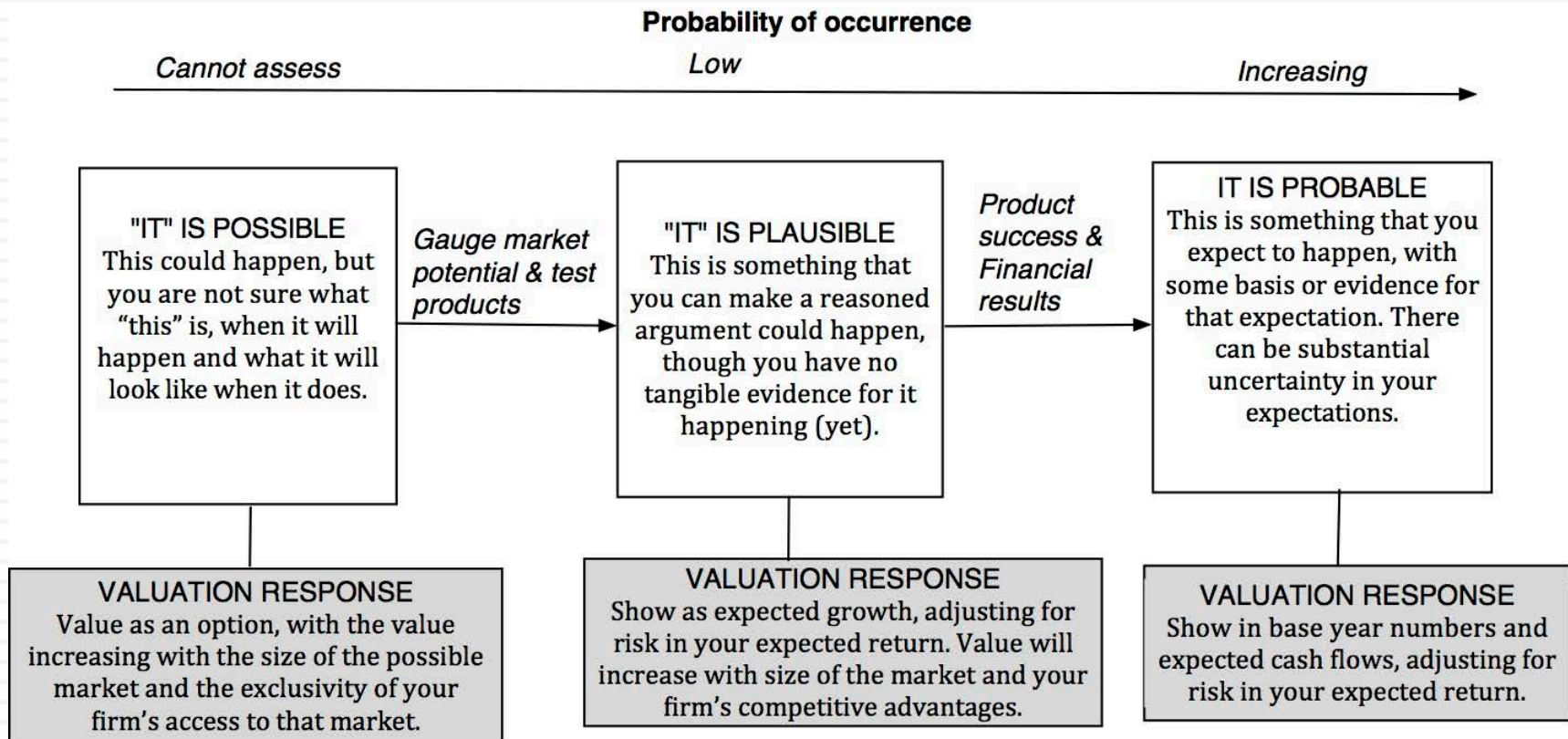

Uber: Possible, Plausible and Probable

Uber (My valuation))

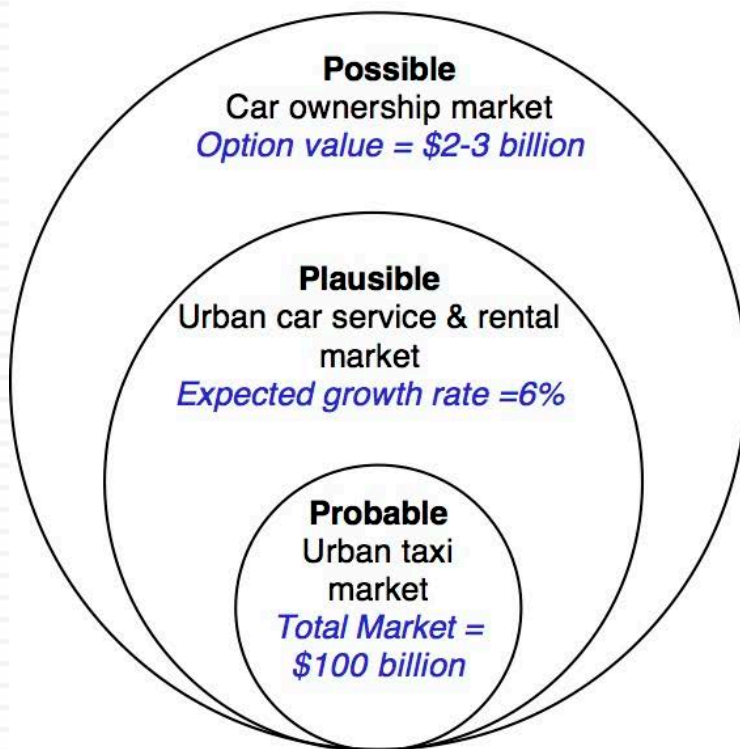

Uber (Bill Gurley)

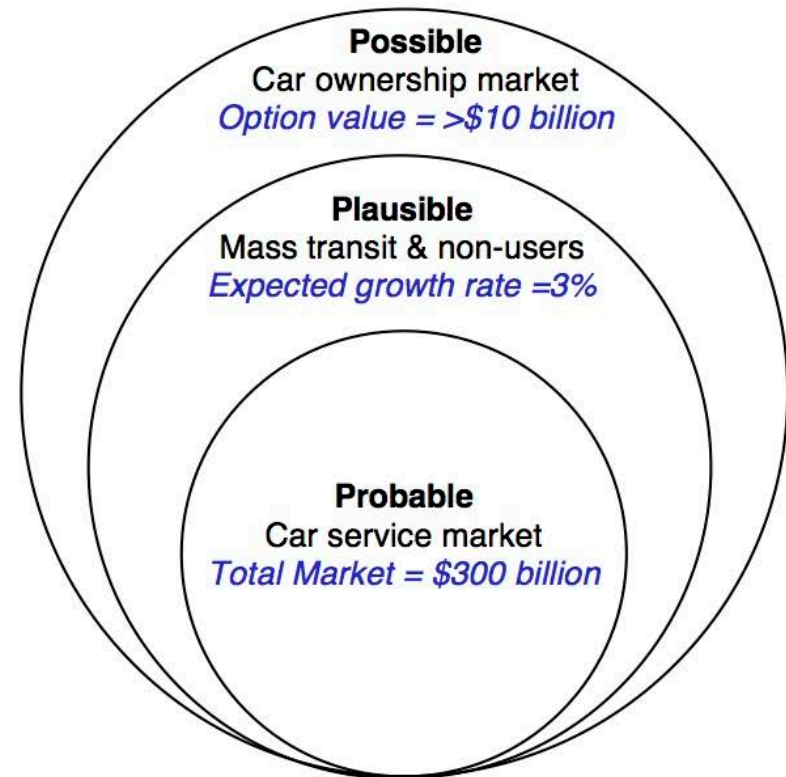

Step 3: Connect your narrative to key drivers of value

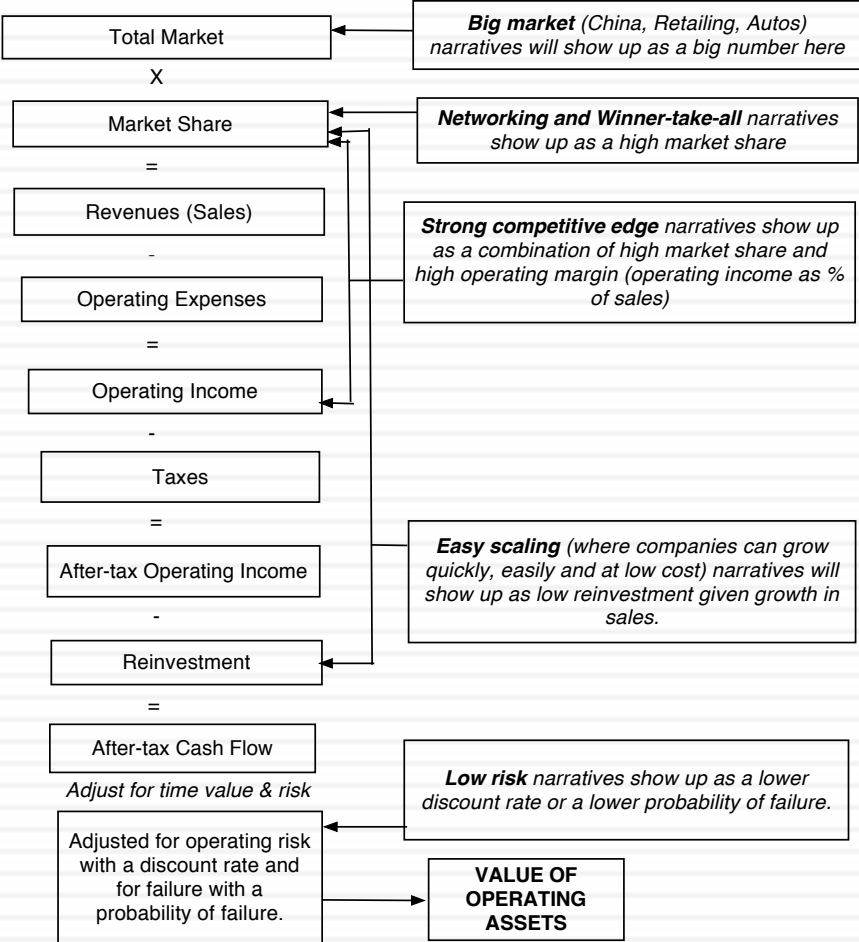

The narrative to numbers

Step	Narrative	Numbers
1	<p><i>What market(s) is (are) Uber's products targeting?</i></p> <p>a. Is Uber just a car service company?</p> <p>b. If not, what other markets do you see Uber competing in?</p>	<p><i>Potential Market</i></p> <p>This sets the limits of growth for the company, and the more broadly defined the market, the larger the potential growth (and the higher the value).</p>
2	<p><i>How will Uber & like products affect market growth?</i></p> <p>a. Given the potential market defined in step 1, how many new users will Uber & like products/services attract into the market?</p> <p>b. What effect will these new users have on overall market growth?</p>	<p><i>Potential Market Growth</i></p> <p>The more new users that a company attracts into the market, the higher the expected growth rate in that market.</p>
3	<p><i>Will Uber derive any network benefits as it grows?</i></p> <p>a. As Uber grows in an existing market, will that make further growth in that market easier (local network effects)?</p> <p>b. If Uber goes into a new market, how much does success in existing markets help it? (global network effects)</p>	<p><i>Market Share</i></p> <p>If there are no network effects in the market, it will stay splintered with no company claiming a significant market share. If there are only local network effects, multiple companies will get significant market shares, but none will be dominant. With global network effects, a company will be able to get a dominant market share.</p>
4	<p><i>What are Uber's competitive advantages?</i></p> <p>a. What are Uber's competitive advantages over existing competitors?</p> <p>b. Will these competitive advantages hold up as the market growth (and new competitors enter)?</p>	<p><i>Cut of gross receipts & Operating Costs</i></p> <p>The slice of revenue that Uber claims of the gross receipts (on cab rides, local delivery etc.) will depend on how strong and sustainable its competitive advantages are, with stronger/more sustainable advantages going along with larger slices of revenues/higher operating margins.</p>
5	<p><i>What will Uber have to invest to generate growth?</i></p> <p>a. Will Uber continue with its existing model (low capital intensity) as it grows?</p> <p>b. Will the growth be organic or acquired?</p>	<p><i>Reinvestment</i></p> <p>The more Uber will have to invest to generate new growth, the less cash flow will be left over for investors (and the lower the value).</p>
6	<p><i>How risky is Uber as an investment?</i></p> <p>a. How much risk is there in Uber's operating businesses?</p> <p>b. What is the chance that Uber will not survive?</p>	<p><i>Risk Adjustment</i></p> <p>The higher the risk in the operating businesses, the higher will be the rate of return (cost of capital) you demand for investing in the company. If failure risk is high, the value will be adjusted down even further.</p>

Step 4: Value the company

136

Uber: Intrinsic valuation - June 8, 2014 (in US \$)

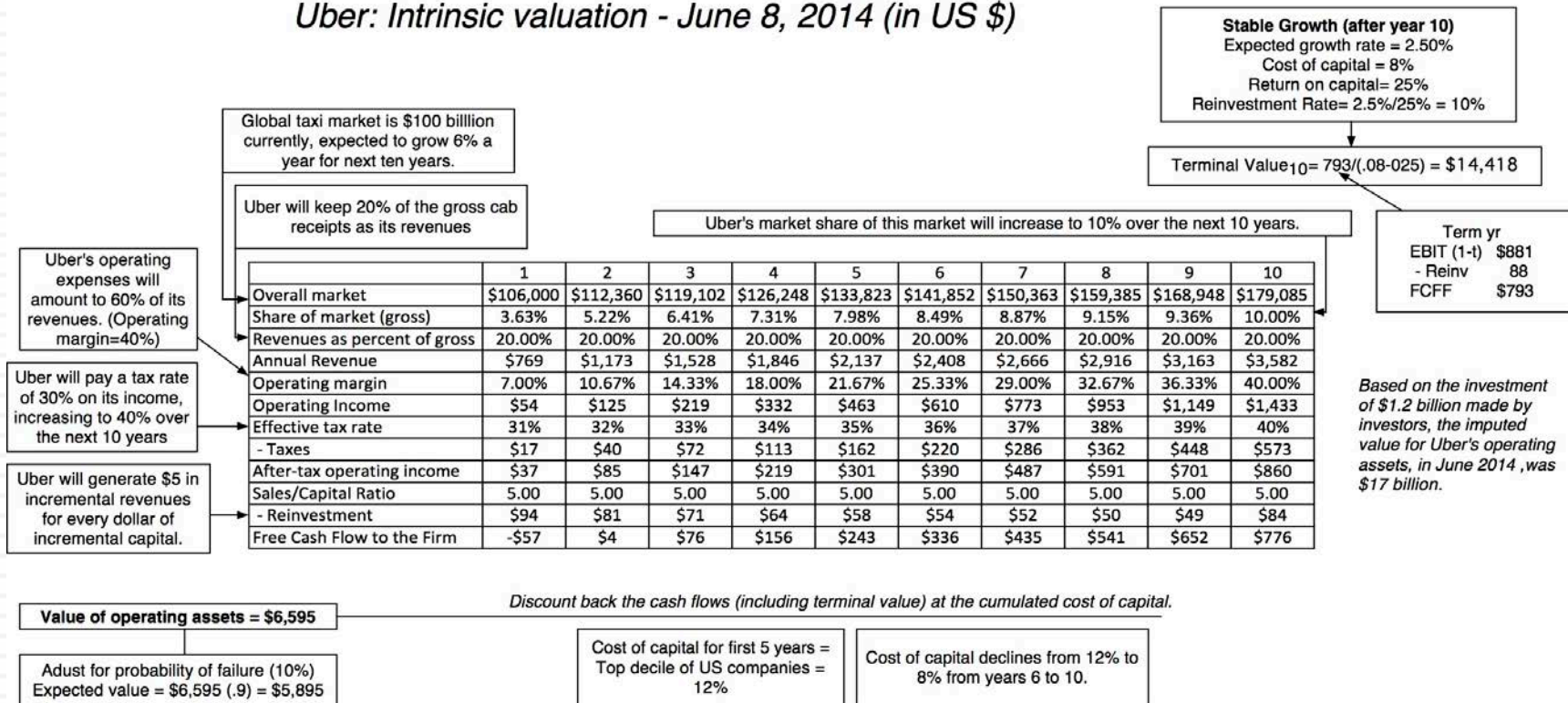

Step 5: Keep the feedback loop

137

	<i>Uber (Gurley)</i>	<i>Uber (Gurley Mod)</i>	<i>Uber (Damodaran)</i>
Narrative	Uber will <u>expand the car service market substantially</u> , bringing in mass transit users & non-users from the suburbs into the market, and use its <u>networking advantage</u> to gain a <u>dominant market share</u> , while maintaining its revenue slice at 20%.	Uber will <u>expand the car service market substantially</u> , bringing in mass transit users & non-users from the suburbs into the market, and use its <u>networking advantage</u> to gain a <u>dominant market share</u> , while cutting prices and margins (to 10%).	Uber will expand the car service market moderately, primarily in urban environments, and use its <u>competitive advantages</u> to get a <u>significant but not dominant market share</u> and maintain its revenue slice at 20%.
Total Market	\$300 billion, growing at 3% a year	\$300 billion, growing at 3% a year	\$100 billion, growing at 6% a year
Market Share	40%	40%	10%
Uber's revenue slice	20%	10%	20%
Value for Uber	\$53.4 billion + Option value of entering car ownership market (\$10 billion+)	\$28.7 billion + Option value of entering car ownership market (\$6 billion+)	\$5.9 billion + Option value of entering car ownership market (\$2-3 billion)

Narratives drive value

<i>Total Market</i>	<i>Growth Effect</i>	<i>Network Effect</i>	<i>Competitive Advantages</i>	<i>Value of Uber</i>
A4. Mobility Services	B4. Double market size	C5. Strong global network effects	D4. Strong & Sustainable	\$90,457
A3. Logistics	B4. Double market size	C5. Strong global network effects	D4. Strong & Sustainable	\$65,158
A4. Mobility Services	B3. Increase market by 50%	C3. Strong local network effects	D3. Semi-strong	\$52,346
A2. All car service	B4. Double market size	C5. Strong global network effects	D4. Strong & Sustainable	\$47,764
A1. Urban car service	B4. Double market size	C5. Strong global network effects	D4. Strong & Sustainable	\$31,952
A3. Logistics	B3. Increase market by 50%	C3. Strong local network effects	D3. Semi-strong	\$14,321
A1. Urban car service	B3. Increase market by 50%	C3. Strong local network effects	D3. Semi-strong	\$7,127
A2. All car service	B3. Increase market by 50%	C3. Strong local network effects	D3. Semi-strong	\$4,764
A4. Mobility Services	B1. None	C1. No network effects	D1. None	\$1,888
A3. Logistics	B1. None	C1. No network effects	D1. None	\$1,417
A2. All car service	B1. None	C1. No network effects	D1. None	\$1,094
A1. Urban car service	B1. None	C1. No network effects	D1. None	\$799

Step 6: Be ready to modify narrative as events unfold

Narrative Break/End	Narrative Shift	Narrative Change (Expansion or Contraction)
Events, external (legal, political or economic) or internal (management, competitive, default), that can cause the narrative to break or end.	Improvement or deterioration in initial business model, changing market size, market share and/or profitability.	Unexpected entry/success in a new market or unexpected exit/failure in an existing market.
Your valuation estimates (cash flows, risk, growth & value) are no longer operative	Your valuation estimates will have to be modified to reflect the new data about the company.	Valuation estimates have to be redone with new overall market potential and characteristics.
Estimate a probability that it will occur & consequences	Monte Carlo simulations or scenario analysis	Real Options



Aswath Damodaran

RELATIVE VALUATION (PRICING)

Aswath Damodaran

Relative valuation is pervasive...

- Most asset valuations are relative.
- Most equity valuations on Wall Street are relative valuations.
 - ▣ Almost 85% of equity research reports are based upon a multiple and comparables.
 - ▣ More than 50% of all acquisition valuations are based upon multiples
 - ▣ Rules of thumb based on multiples are not only common but are often the basis for final valuation judgments.
- While there are more discounted cashflow valuations in consulting and corporate finance, they are often relative valuations masquerading as discounted cash flow valuations.
 - ▣ The objective in many discounted cashflow valuations is to back into a number that has been obtained by using a multiple.
 - ▣ The terminal value in a significant number of discounted cashflow valuations is estimated using a multiple.

The Reasons for the allure...

- “If you think I’m crazy, you should see the guy who lives across the hall”

Jerry Seinfeld talking about Kramer in a Seinfeld episode

- “A little inaccuracy sometimes saves tons of explanation”

H.H. Munro

- “If you are going to screw up, make sure that you have lots of company”

Ex-portfolio manager

Pricing versus Valuation

143

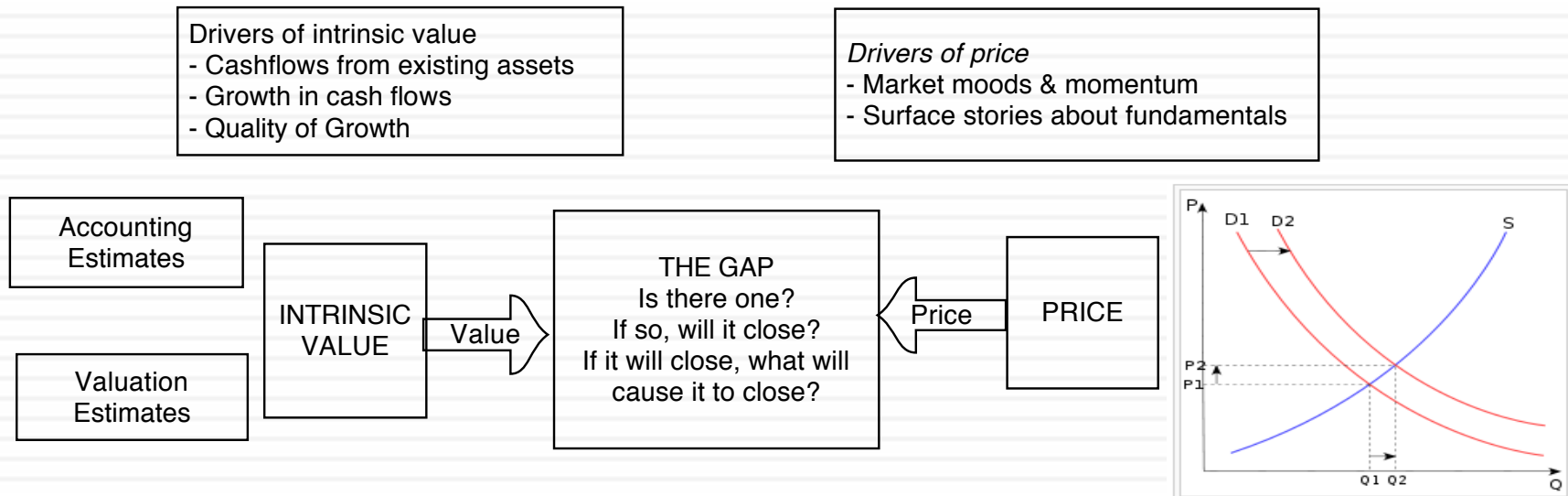

Test 1: Are you pricing or valuing?

144

 **5369 La Jolla Mesa Dr**
La Jolla, CA 92037
Status: Active





\$995,000
Price

3
Beds

2.5
Baths

1,440 Sq. Ft.
\$691 / Sq. Ft.













Built: 1955 Lot Size: 3,000 Sq. Ft. On Redfin: 12 days

   

Favorite X-Out Share... Tour Home

Overview Property Details Tour Insights Property History Public Records Activity Schools Neighborhood & Offer Insights Similar Homes



1 of 25            

Lisa Padilla
REDFIN Real Estate Agent
★★★★★
47 client reviews
\$8,726 commission refund

[Ask Lisa a Question or Start an Offer](#)

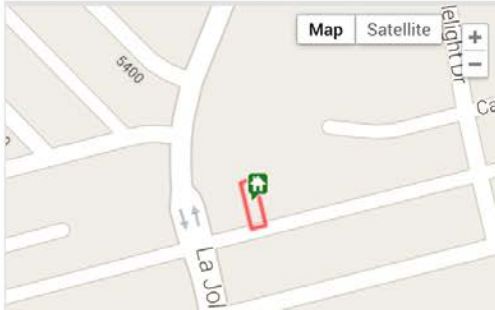
1 of 4 Redfin Agents in this area



Map Satellite

Test 2: Are you pricing or valuing?

145

Europe
Switzerland

Biotechnology
Biotechnology

Reuters BION.S Bloomberg BION SW Exchange SWX Ticker BION

Price at 12 Aug 2013 (CHF)	124.00
Price Target (CHF)	164.50
52-week range (CHF)	128.40 - 84.90

Strong sector and stock-picking continue

Impressive performance

Over the past two years, BB Biotech shares have roughly tripled, which could tempt investors to take profits. However, this performance has been well backed by a deserved revival of the biotech industry, encouraging fundamental news, M&A, and increased money flow into health care stocks. In addition, BBB returned to index outperformance by modifying its stock-picking approach. Hence, despite excellent performance, the shares still trade at a 23% discount to the net asset value of the portfolio. Hence, the shares are an attractive value vehicle to capture growth opportunities in an attractive sector.

Biotech industry remains attractive

With the re-rating of the pharma sector, investors have also showed increased interest in biotech stocks. Established biotech stocks have delivered encouraging financial results and approvals, while there has also been substantial industry consolidation, which is not surprising in times of "cheap" money and high liquidity. BB Biotech remains an attractive vehicle to capture the future potential of the biotech sector. In addition, investors benefit from a 23% discount to NAV and attractive cash distribution policy of 5% yield p.a. Hence, we reiterate our Buy on BB Biotech shares.

Key changes

Target Price 106.50 to 164.50 ↑ 54.5%

Source: Deutsche Bank

Price/price relative

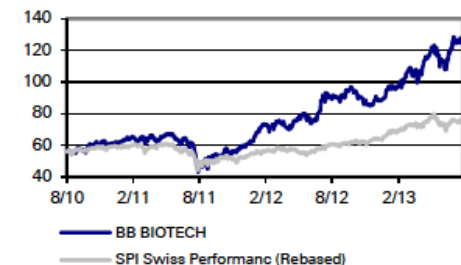

Performance (%)	1m	3m	12m
Absolute	-1.4	5.4	37.4

Test 3: Are you pricing or valuing?

146

	1	2	3	4	5
EBITDA	\$100.00	\$120.00	\$144.00	\$172.80	\$207.36
- Depreciation	\$20.00	\$24.00	\$28.80	\$34.56	\$41.47
EBIT	\$80.00	\$96.00	\$115.20	\$138.24	\$165.89
- Taxes	\$24.00	\$28.80	\$34.56	\$41.47	\$49.77
EBIT (1-t)	\$56.00	\$67.20	\$80.64	\$96.77	\$116.12
+ Depreciation	\$20.00	\$24.00	\$28.80	\$34.56	\$41.47
- Cap Ex	\$50.00	\$60.00	\$72.00	\$86.40	\$103.68
- Chg in WC	\$10.00	\$12.00	\$14.40	\$17.28	\$20.74
FCFF	\$16.00	\$19.20	\$23.04	\$27.65	\$33.18
Terminal Value					\$1,658.88
Cost of capital	8.25%	8.25%	8.25%	8.25%	8.25%
Present Value	\$14.78	\$16.38	\$18.16	\$20.14	\$1,138.35
Value of operating assets today	\$1,207.81				
+ Cash	\$125.00				
- Debt	\$200.00				
Value of equity	\$1,132.81				

The tool for pricing: A multiple

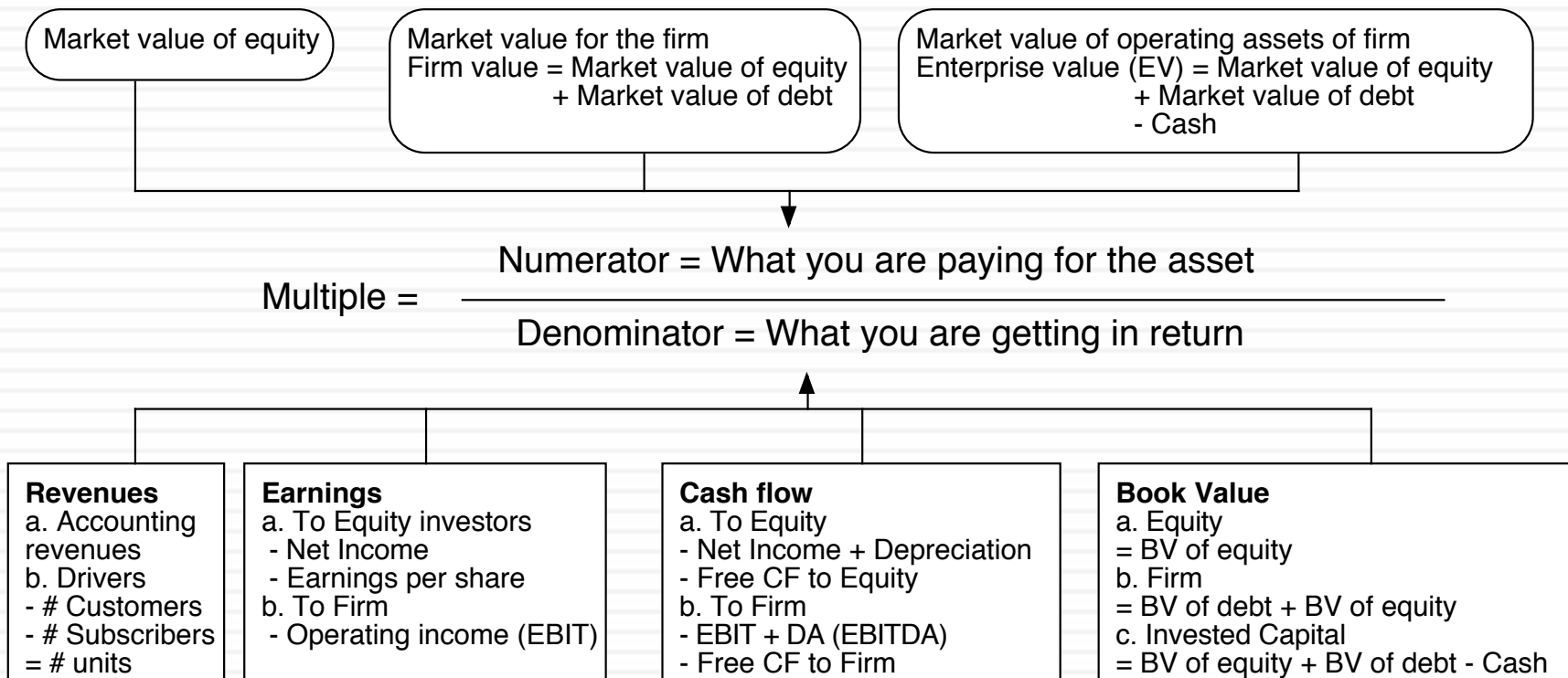

The Four Steps to Deconstructing Multiples

- Define the multiple
 - In use, the same multiple can be defined in different ways by different users. When comparing and using multiples, estimated by someone else, it is critical that we understand how the multiples have been estimated
- Describe the multiple
 - Too many people who use a multiple have no idea what its cross sectional distribution is. If you do not know what the cross sectional distribution of a multiple is, it is difficult to look at a number and pass judgment on whether it is too high or low.
- Analyze the multiple
 - It is critical that we understand the fundamentals that drive each multiple, and the nature of the relationship between the multiple and each variable.
- Apply the multiple
 - Defining the comparable universe and controlling for differences is far more difficult in practice than it is in theory.

Definitional Tests

- Is the multiple consistently defined?
 - Proposition 1: Both the value (the numerator) and the standardizing variable (the denominator) should be to the same claimholders in the firm. In other words, the value of equity should be divided by equity earnings or equity book value, and firm value should be divided by firm earnings or book value.
- Is the multiple uniformly estimated?
 - The variables used in defining the multiple should be estimated uniformly across assets in the “comparable firm” list.
 - If earnings-based multiples are used, the accounting rules to measure earnings should be applied consistently across assets. The same rule applies with book-value based multiples.

Example 1: Price Earnings Ratio: Definition

PE = Market Price per Share / Earnings per Share

- There are a number of variants on the basic PE ratio in use. They are based upon how the price and the earnings are defined.

Price: is usually the current price

is sometimes the average price for the year

EPS: EPS in most recent financial year

EPS in trailing 12 months (Trailing PE)

Forecasted EPS next year (Forward PE)

Forecasted EPS in future year

Example 2: Enterprise Value /EBITDA Multiple

- The enterprise value to EBITDA multiple is obtained by netting cash out against debt to arrive at enterprise value and dividing by EBITDA.

$$\frac{\text{Enterprise Value}}{\text{EBITDA}} = \frac{\text{Market Value of Equity} + \text{Market Value of Debt} - \text{Cash}}{\text{Earnings before Interest, Taxes and Depreciation}}$$

- Why do we net out cash from firm value?
- What happens if a firm has cross holdings which are categorized as:
 - ▣ Minority interests?
 - ▣ Majority active interests?

Descriptive Tests

- What is the average and standard deviation for this multiple, across the universe (market)?
- What is the median for this multiple?
 - The median for this multiple is often a more reliable comparison point.
- How large are the outliers to the distribution, and how do we deal with the outliers?
 - Throwing out the outliers may seem like an obvious solution, but if the outliers all lie on one side of the distribution (they usually are large positive numbers), this can lead to a biased estimate.
- Are there cases where the multiple cannot be estimated? Will ignoring these cases lead to a biased estimate of the multiple?
- How has this multiple changed over time?

1. Multiples have skewed distributions...

PE Ratios for US stocks: January 2014

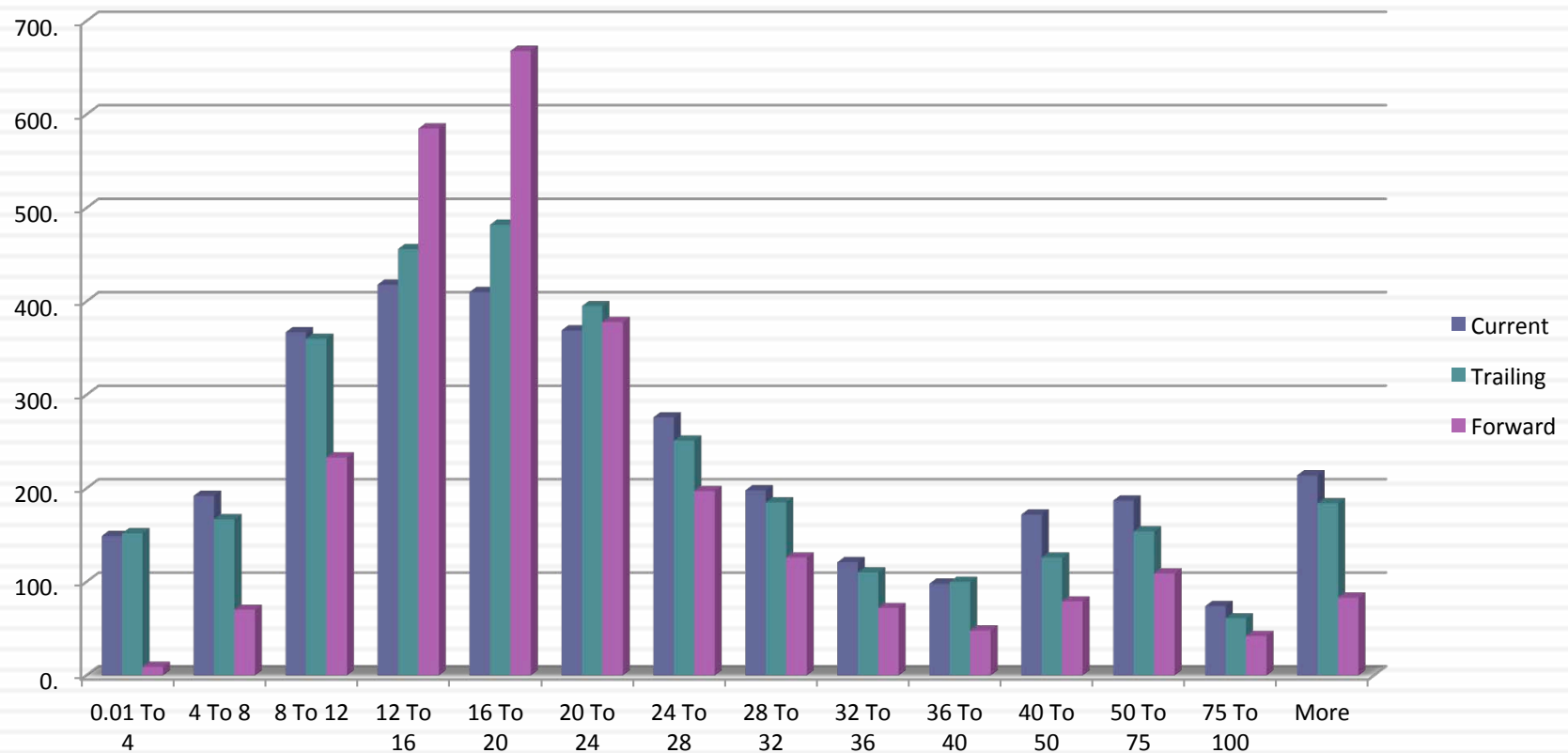

2. Making statistics “dicey”

	<i>Current PE</i>	<i>Trailing PE</i>	<i>Forward PE</i>
Number of firms	7766	7766	7766
Number with PE	3248	3186	2699
Average	52.13	50.14	38.62
Median	20.78	19.75	18.54
Minimum	0.25	0.4	0.52
Maximum	7,117.43	7,117.43	16,820.
Standard deviation	242.03	249.64	349.38
Standard error	4.25	4.42	6.72
Skewness	18.29	17.62	42.99
25th percentile	13.004	12.97	14.7
75th percentile	33.66	30.47	25.13

3. Markets have a lot in common : Comparing Global PEs

PE Ratio Distribution: Global Comparison in January 2014

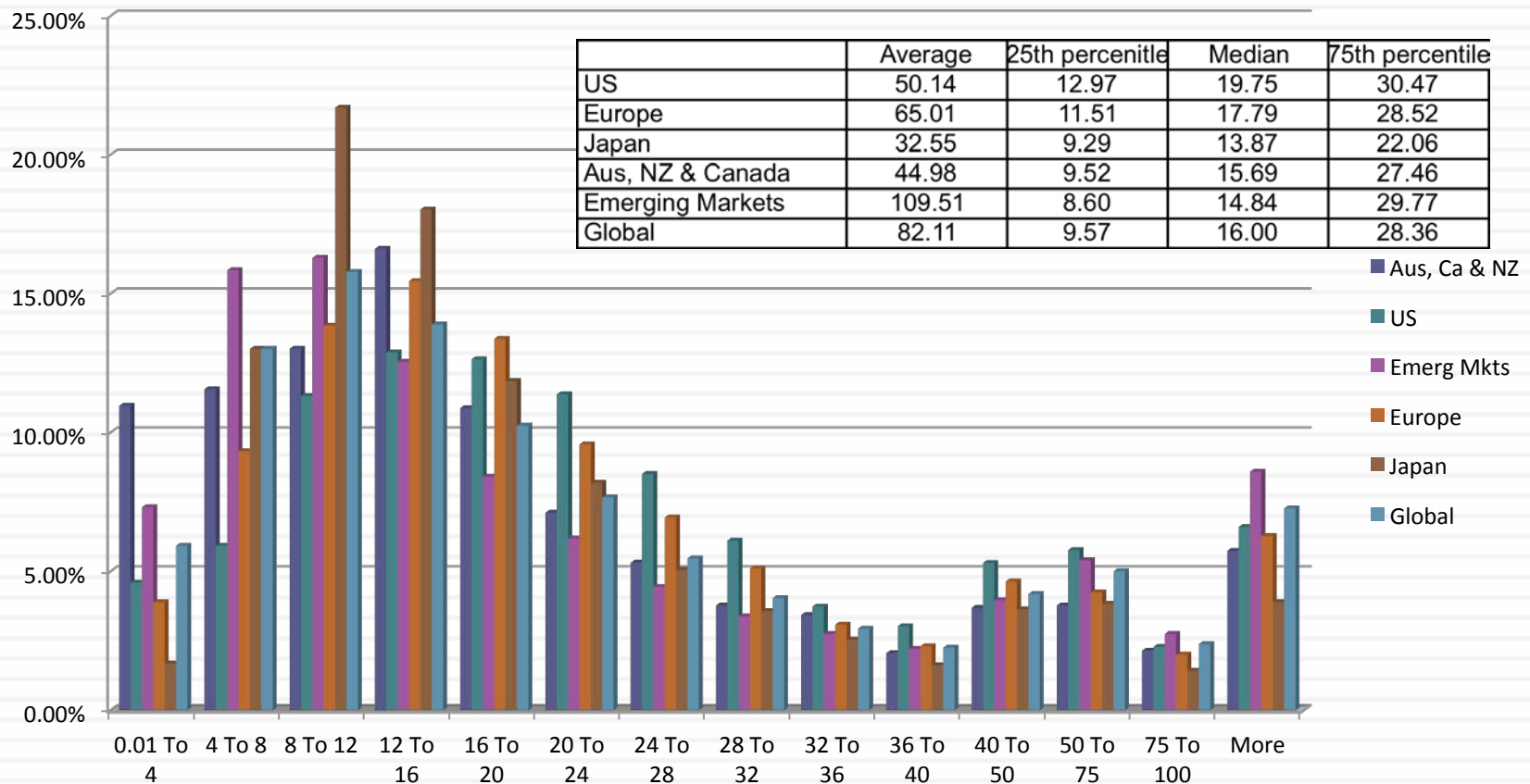

4. Simplistic rules almost always break down...6 times EBITDA may not be cheap...

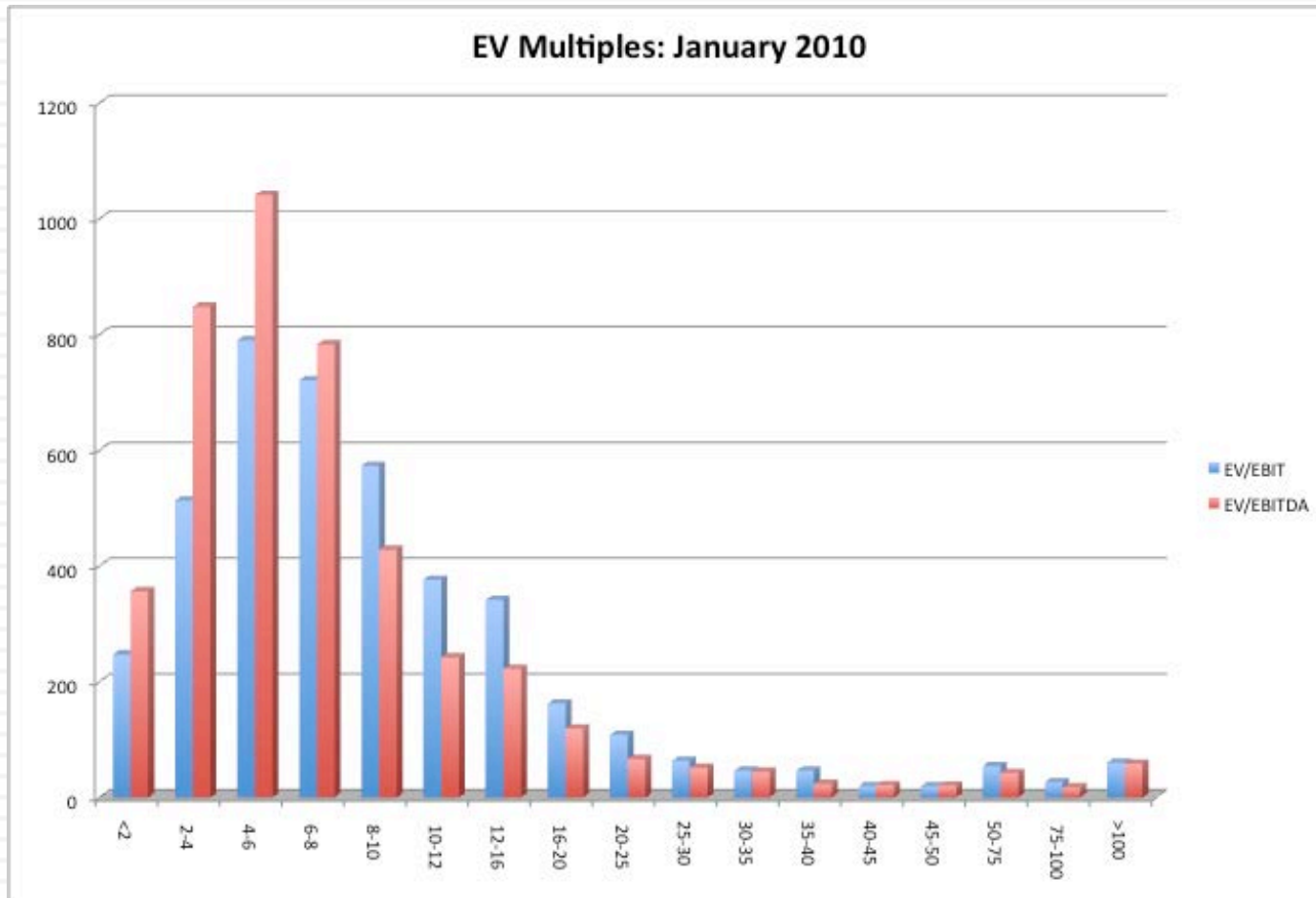

But it may be in 2014, unless you are in Japan or in some emerging markets...

EV/EBITDA: A Global Comparison - January 2014

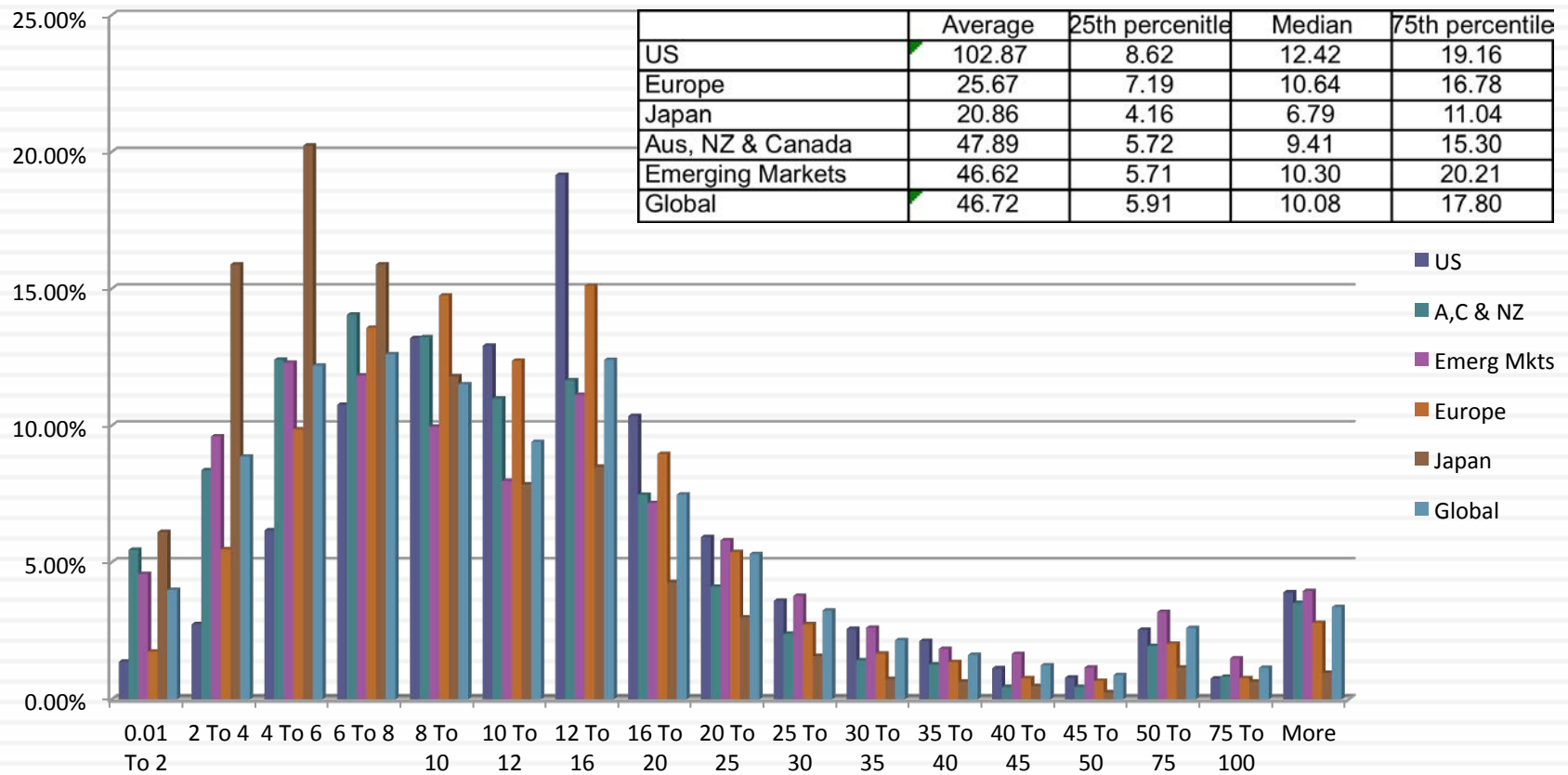

Analytical Tests

- What are the fundamentals that determine and drive these multiples?
 - Proposition 2: Embedded in every multiple are all of the variables that drive every discounted cash flow valuation - growth, risk and cash flow patterns.
 - In fact, using a simple discounted cash flow model and basic algebra should yield the fundamentals that drive a multiple
- How do changes in these fundamentals change the multiple?
 - The relationship between a fundamental (like growth) and a multiple (such as PE) is seldom linear. For example, if firm A has twice the growth rate of firm B, it will generally not trade at twice its PE ratio
 - Proposition 3: It is impossible to properly compare firms on a multiple, if we do not know the nature of the relationship between fundamentals and the multiple.

PE Ratio: Understanding the Fundamentals

- To understand the fundamentals, start with a basic equity discounted cash flow model.
- With the dividend discount model,

$$P_0 = \frac{DPS_1}{r - g_n}$$

- Dividing both sides by the current earnings per share,

$$\frac{P_0}{EPS_0} = PE = \frac{\text{Payout Ratio} * (1 + g_n)}{r - g_n}$$

- If this had been a FCFE Model,

$$P_0 = \frac{FCFE_1}{r - g_n}$$

$$\frac{P_0}{EPS_0} = PE = \frac{(\text{FCFE/Earnings}) * (1 + g_n)}{r - g_n}$$

The Determinants of Multiples...

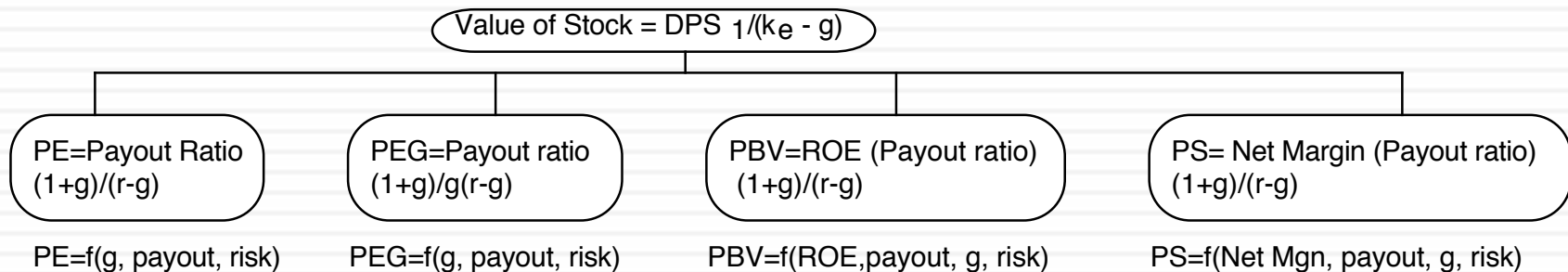

Equity Multiples

Firm Multiples

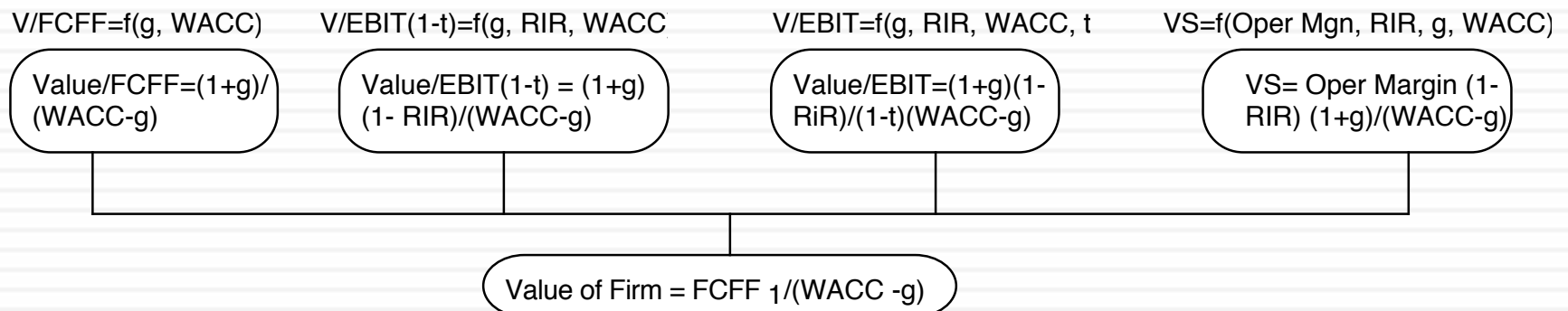

Application Tests

- Given the firm that we are valuing, what is a “comparable” firm?
 - While traditional analysis is built on the premise that firms in the same sector are comparable firms, valuation theory would suggest that a comparable firm is one which is similar to the one being analyzed in terms of fundamentals.
 - Proposition 4: There is no reason why a firm cannot be compared with another firm in a very different business, if the two firms have the same risk, growth and cash flow characteristics.
- Given the comparable firms, how do we adjust for differences across firms on the fundamentals?
 - Proposition 5: It is impossible to find an exactly identical firm to the one you are valuing.

An Example: Comparing PE Ratios across a Sector: PE

<i>Company Name</i>	<i>PE</i>	<i>Growth</i>
<i>PT Indosat ADR</i>	7.8	0.06
<i>Telebras ADR</i>	8.9	0.075
<i>Telecom Corporation of New Zealand ADR</i>	11.2	0.11
<i>Telecom Argentina Stet - France Telecom SA ADR B</i>	12.5	0.08
<i>Hellenic Telecommunication Organization SA ADR</i>	12.8	0.12
<i>Telecomunicaciones de Chile ADR</i>	16.6	0.08
<i>Swisscom AG ADR</i>	18.3	0.11
<i>Asia Satellite Telecom Holdings ADR</i>	19.6	0.16
<i>Portugal Telecom SA ADR</i>	20.8	0.13
<i>Telefonos de Mexico ADR L</i>	21.1	0.14
<i>Matav RT ADR</i>	21.5	0.22
<i>Telstra ADR</i>	21.7	0.12
<i>Gilat Communications</i>	22.7	0.31
<i>Deutsche Telekom AG ADR</i>	24.6	0.11
<i>British Telecommunications PLC ADR</i>	25.7	0.07
<i>Tele Danmark AS ADR</i>	27	0.09
<i>Telekomunikasi Indonesia ADR</i>	28.4	0.32
<i>Cable & Wireless PLC ADR</i>	29.8	0.14
<i>APT Satellite Holdings ADR</i>	31	0.33
<i>Telefonica SA ADR</i>	32.5	0.18
<i>Royal KPN NV ADR</i>	35.7	0.13
<i>Telecom Italia SPA ADR</i>	42.2	0.14
<i>Nippon Telegraph & Telephone ADR</i>	44.3	0.2
<i>France Telecom SA ADR</i>	45.2	0.19
<i>Korea Telecom ADR</i>	71.3	0.44

PE, Growth and Risk

- Dependent variable is: PE
- R squared = 66.2% R squared (adjusted) = 63.1%

<i>Variable</i>		<i>Coefficient</i>	<i>SE</i>	<i>t-ratio</i>	<i>Probability</i>
Constant	13.1151	3.471	3.78	0.0010	
Growth rate	121.223	19.27	6.29	≤ 0.0001	
Emerging Market	-13.853	1	3.606	-3.84	0.0009
Emerging Market is a dummy:			1 if emerging market		
			0 if not		

- Is Indosat cheap?

$$PE = 13.13 + 121.22 (.06) - 13.85 (1) = 6.55$$

At 7.8 times earnings, Indosat is over valued.

Indofoods: A Relative Valuation

<i>Company Name</i>	<i>PE</i>	<i>PBV</i>	<i>EV/ EBITDA</i>	<i>EV/Sales</i>	<i>ROE</i>	<i>ROIC</i>	<i>Expected growth</i>	<i>Effective tax rate</i>	<i>Operating Margin</i>	<i>Net Margin</i>
Sampoerna Agro Tbk (JKSE:SGRO)	40.64	1.79	13.27	2.33	4.41%	4.27%	-26.20%	30.70%	9.22%	4.65%
PT Charoen Pokphand Indonesia Tbk (JKSE:CPIN)	25.38	6.45	15.23	2.57	25.43%	25.07%	6.40%	26.70%	15.59%	9.86%
PT Indofood Sukses Makmur Tbk (JKSE:INDF)	26.17	1.71	9.54	1.37	6.52%	8.75%	9.63%	26.80%	10.78%	4.34%
PT Indofood CBP Sukses Makmur Tbk (JKSE:ICBP)	27.67	4.64	17.92	2.33	16.77%	20.26%	11.60%	24.70%	11.00%	8.87%
PT Japfa Comfeed Indonesia Tbk (JKSE:JPFA)	23.38	2.65	9.08	0.92	11.34%	11.60%	12.00%	28.50%	8.42%	2.78%
PT Malindo Feedmill Tbk (JKSE:MAIN)	22.74	6.35	11.08	1.52	27.93%	21.29%	15.00%	22.30%	11.58%	5.74%
PT Astra Agro Lestari Tbk (JKSE:AALI)	20.54	4.14	13.12	3.49	20.17%	19.20%	16.40%	28.00%	25.39%	16.30%
Mayora Indah PT (JKSE:MYOR)	25.97	6.87	17.41	2.42	26.44%	17.10%	17.80%	22.00%	10.86%	8.66%
PT Perusahaan Perkebunan London Sumatra Indonesia Tbk (JKSE:LSIP)	22.31	2.60	14.01	3.82	11.64%	12.33%	24.60%	22.90%	20.16%	18.63%
PT Sawit Sumbermas Sarana Tbk (JKSE:SSMS)	21.68	5.40	12.15	6.47	24.89%	26.95%	28.00%	26.00%	46.56%	29.39%
Bumitama Agri Ltd (SGX:P8Z)	22.44	3.13	15.50	5.62	13.93%	10.60%	29.70%	22.60%	33.05%	21.05%
PT Nippon Indosari Corpindo Tbk (JKSE:ROTI)	37.43	7.52	21.82	4.30	20.09%	13.04%	30.00%	25.00%	15.51%	10.50%
PT Tiga Pilar Sejahtera Food Tbk (JKSE:AISA)	22.26	2.93	12.06	2.15	13.16%	11.39%	30.70%	22.90%	15.17%	7.65%
PT. BW Plantation, Tbk (JKSE:BWPT)	36.55	3.03	21.05	8.88	8.30%	4.06%	54.70%	28.70%	28.48%	15.83%
Median	24.38	3.63	13.64	2.49	15.35%	12.68%	17.10%	25.50%	15.34%	9.36%

PBV and Return on Equity: Food companies

- On a price to book ratio basis, Indofoods looks cheap, trading at 1.71 times book value, whereas the median for the sector is 3.63. However, Indofoods also has a ROE of 6.52%, below the median for the sector of 15.35%.

- Regressing PBV against ROE across the 15 companies:

$$\text{PBV} = 0.47 + 22.80 (\text{ROE}) \quad R^2 = 81\%$$

(.81) (7.13)

- Plugging in Indofoods return on equity of 6.52%

$$\text{PBV for Indofoods} = 0.47 + 22.8 (.0652) = 1.96$$

(At 1.71 times book value, Indofoods is undervalued (by about 13%).

Comparisons to the entire market: Why not?

- In contrast to the 'comparable firm' approach, the information in the entire cross-section of firms can be used to predict PE ratios.
- The simplest way of summarizing this information is with a multiple regression, with the PE ratio as the dependent variable, and proxies for risk, growth and payout forming the independent variables.

PE Ratio: Standard Regression for US stocks - January 2014

167

Model Summary

Model	R	R Square	Adjusted R Square	Std. Error of the Estimate
1	.580 ^a	.336	.335	1562.73006

a. Predictors: (Constant), Payout Ratio, Expected Growth in EPS (next 5 years), Regression Beta

The regression is run with growth and payout entered as decimals, i.e., 25% is entered as 0.25)

Model	Unstandardized Coefficients		t	Sig.	
	B	Std. Error			
1	(Constant)	4.199	1.255	3.346	.001
	Regression Beta	-2.864	.977	-2.932	.003
	Expected Growth in EPS (next 5 years)	149.0	5.56	26.819	.000
	Payout Ratio	13.39	.70	18.502	.000

PE ratio regressions across markets

168

Region	Regression – January 2014	R ²
US	PE = 4.20 + 149.0 g _{EPS} + 13.40 Payout - 2.86 Beta	33.6%
Europe	PE = 11.51 + 41.73 g _{EPS} + 14.36 Payout - 1.75 Beta	37.7%
Japan	PE = 11.01 + 17.30 g _{EPS} + 31.22 Payout	16.9%
Emerging Markets	PE = 8.52 + 56.2 g _{EPS} + 10.04 Payout - 1.43 Beta	20.0%
Global	PE = 11.79 + 50.39 g _{EPS} + 15.86 Payout - 1.01 Beta - 61.15 ERP	33.1%

g_{EPS} = Expected Growth: Expected growth in EPS or Net Income: Next 5 years

Beta: Regression or Bottom up Beta

Payout ratio: Dividends/ Net income from most recent year. Set to zero, if net income < 0

ERP: Equity Risk Premium (total) for country in which company is incorporated

Choosing Between the Multiples

- As presented in this section, there are dozens of multiples that can be potentially used to value an individual firm.
- In addition, relative valuation can be relative to a sector (or comparable firms) or to the entire market (using the regressions, for instance)
- Since there can be only one final estimate of value, there are three choices at this stage:
 - Use a simple average of the valuations obtained using a number of different multiples
 - Use a weighted average of the valuations obtained using a number of different multiples
 - Choose one of the multiples and base your valuation on that multiple

Picking one Multiple

- This is usually the best way to approach this issue. While a range of values can be obtained from a number of multiples, the “best estimate” value is obtained using one multiple.
- The multiple that is used can be chosen in one of two ways:
 - Use the multiple that best fits your objective. Thus, if you want the company to be undervalued, you pick the multiple that yields the highest value.
 - Use the multiple that has the highest R-squared in the sector when regressed against fundamentals. Thus, if you have tried PE, PBV, PS, etc. and run regressions of these multiples against fundamentals, use the multiple that works best at explaining differences across firms in that sector.
 - Use the multiple that seems to make the most sense for that sector, given how value is measured and created.

Conventional usage...

Sector	Multiple Used	Rationale
Cyclical Manufacturing	PE, Relative PE	Often with normalized earnings
Growth firms	PEG ratio	Big differences in growth rates
Young growth firms w/ losses	Revenue Multiples	What choice do you have?
Infrastructure	EV/EBITDA	Early losses, big DA
REIT	P/CFE (where CFE = Net income + Depreciation)	Big depreciation charges on real estate
Financial Services	Price/ Book equity	Marked to market?
Retailing	Revenue multiples	Margins equalize sooner or later

A closing thought...

