



VALUATION: ART, SCIENCE OR MAGIC?

Some Initial Thoughts

" One hundred thousand lemmings cannot be wrong"

Graffiti

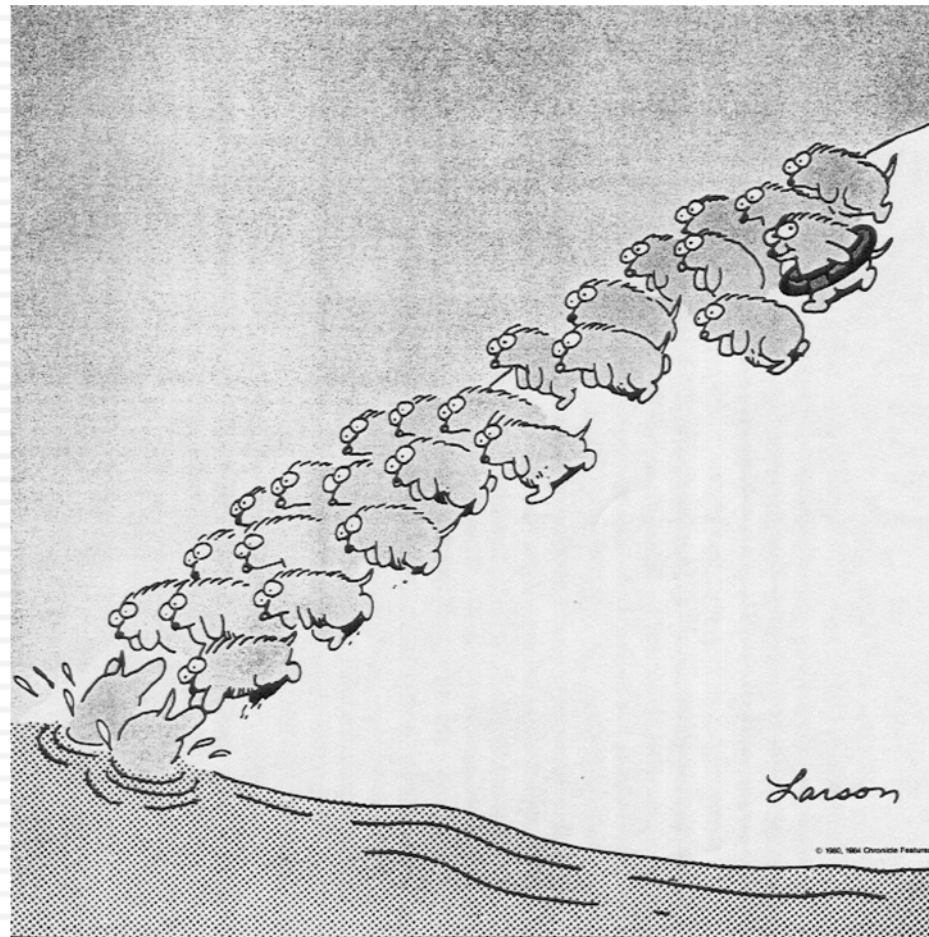

Aswath Damodaran

Theme 1: Characterizing Valuation as a discipline

- In a science, if you get the inputs right, you should get the output right. The laws of physics and mathematics are universal and there are no exceptions. **Valuation is not a science.**
- In an art, there are elements that can be taught but there is also a magic that you either have or you do not. The essence of an art is that you are either a great artist or you are not. **Valuation is not an art.**
- A craft is a skill that you learn by doing. The more you do it, the better you get at it. **Valuation is a craft.**

Theme 2: Valuing an asset is not the same as pricing that asset

Drivers of intrinsic value

- Cashflows from existing assets
- Growth in cash flows
- Quality of Growth

Drivers of price

- Market moods & momentum
- Surface stories about fundamentals

Accounting Estimates

Valuation Estimates

INTRINSIC VALUE

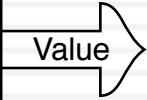

THE GAP
Is there one?
If so, will it close?
If it will close, what will cause it to close?



PRICE

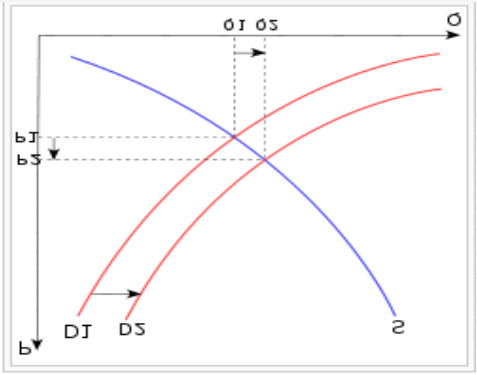

Theme 3: Good valuation = Story + Numbers

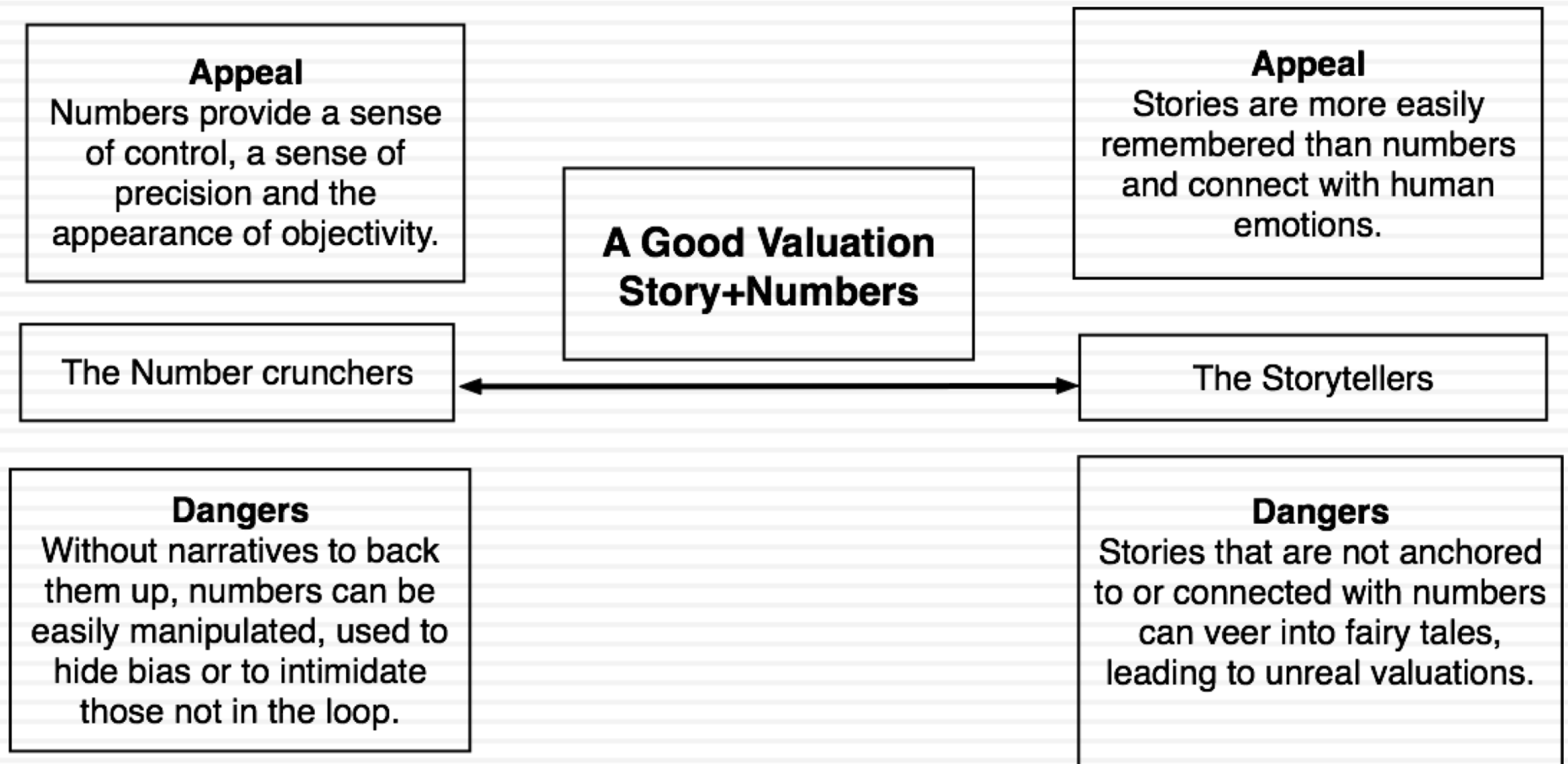

Theme 4: If you value something, you should be willing to act on it..

- What theory? There is very little theory in valuation and I am not sure what an academic valuation would like like and am not sure that I want to find out.
- Pragmatism, not purity: The end game is to estimate a value for an asset. I plan to get there, even if it means taking short cuts and making assumptions that would make purists blanch.
- Faith: To act on your valuations, you have to have faith in
 - ▣ In your own valuation judgments.
 - ▣ In markets: that prices will move towards your value estimates.That faith will have to be earned and will be tested.

Misconceptions about Valuation

- Myth 1: A valuation is an objective search for “true” value
 - Truth 1.1: All valuations are biased. The only questions are how much and in which direction.
 - Truth 1.2: The direction and magnitude of the bias in your valuation is directly proportional to who pays you and how much you are paid.
- Myth 2.: A good valuation provides a precise estimate of value
 - Truth 2.1: There are no precise valuations.
 - Truth 2.2: The payoff to valuation is greatest when valuation is least precise.
- Myth 3: . The more quantitative a model, the better the valuation
 - Truth 3.1: One’ s understanding of a valuation model is inversely proportional to the number of inputs required for the model.
 - Truth 3.2: Simpler valuation models do much better than complex ones.

Approaches to Valuation

- **Intrinsic valuation**, relates the value of an asset to the present value of expected future cashflows on that asset. In its most common form, this takes the form of a discounted cash flow valuation.
- **Relative valuation**, estimates the value of an asset by looking at the pricing of 'comparable' assets relative to a common variable like earnings, cash flows, book value or sales.
- **Contingent claim valuation**, uses option pricing models to measure the value of assets that share option characteristics.

Discounted Cash Flow Valuation

- *What is it:* In discounted cash flow valuation, the value of an asset is the present value of the expected cash flows on the asset.
- *Philosophical Basis:* Every asset has an intrinsic value that can be estimated, based upon its characteristics in terms of cash flows, growth and risk.
- *Information Needed:* To use discounted cash flow valuation, you need
 - ▣ to estimate the life of the asset
 - ▣ to estimate the cash flows during the life of the asset
 - ▣ to estimate the discount rate to apply to these cash flows to get present value
- *Market Inefficiency:* Markets are assumed to make mistakes in pricing assets across time, and are assumed to correct themselves over time, as new information comes out about assets.

Risk Adjusted Value: Three Basic Propositions

- The value of a risky asset can be estimated by discounting the expected cash flows on the asset over its life at a risk-adjusted discount rate:

$$\text{Value of asset} = \frac{E(\text{CF}_1)}{(1+r)} + \frac{E(\text{CF}_2)}{(1+r)^2} + \frac{E(\text{CF}_3)}{(1+r)^3} \dots + \frac{E(\text{CF}_n)}{(1+r)^n}$$

1. *The IT Proposition:* If “it” does not affect the cash flows or alter risk (thus changing discount rates), “it” cannot affect value.
2. *The DUH Proposition:* For an asset to have value, the expected cash flows have to be positive some time over the life of the asset.
3. *The DON'T FREAK OUT Proposition:* Assets that generate cash flows early in their life will be worth more than assets that generate cash flows later; the latter may however have greater growth and higher cash flows to compensate.

DCF Choices: Equity Valuation versus Firm Valuation

Firm Valuation: Value the entire business

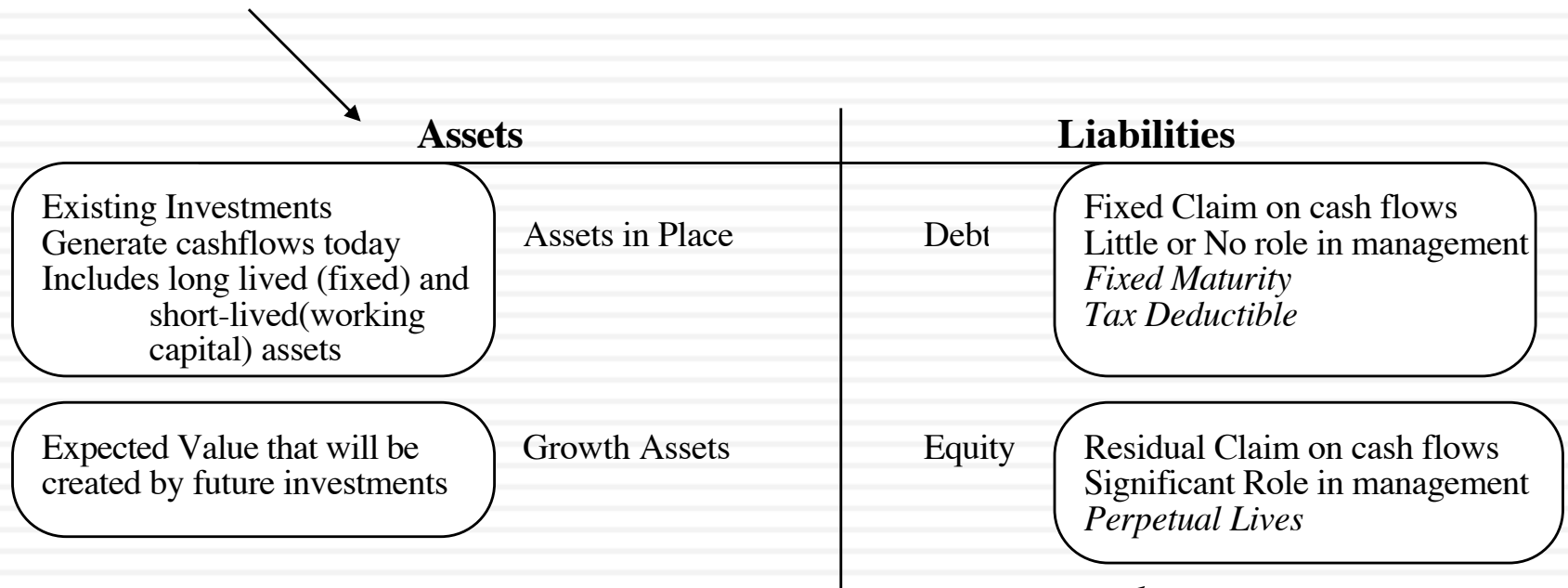

Equity valuation: Value just the equity claim in the business

The Drivers of Value...

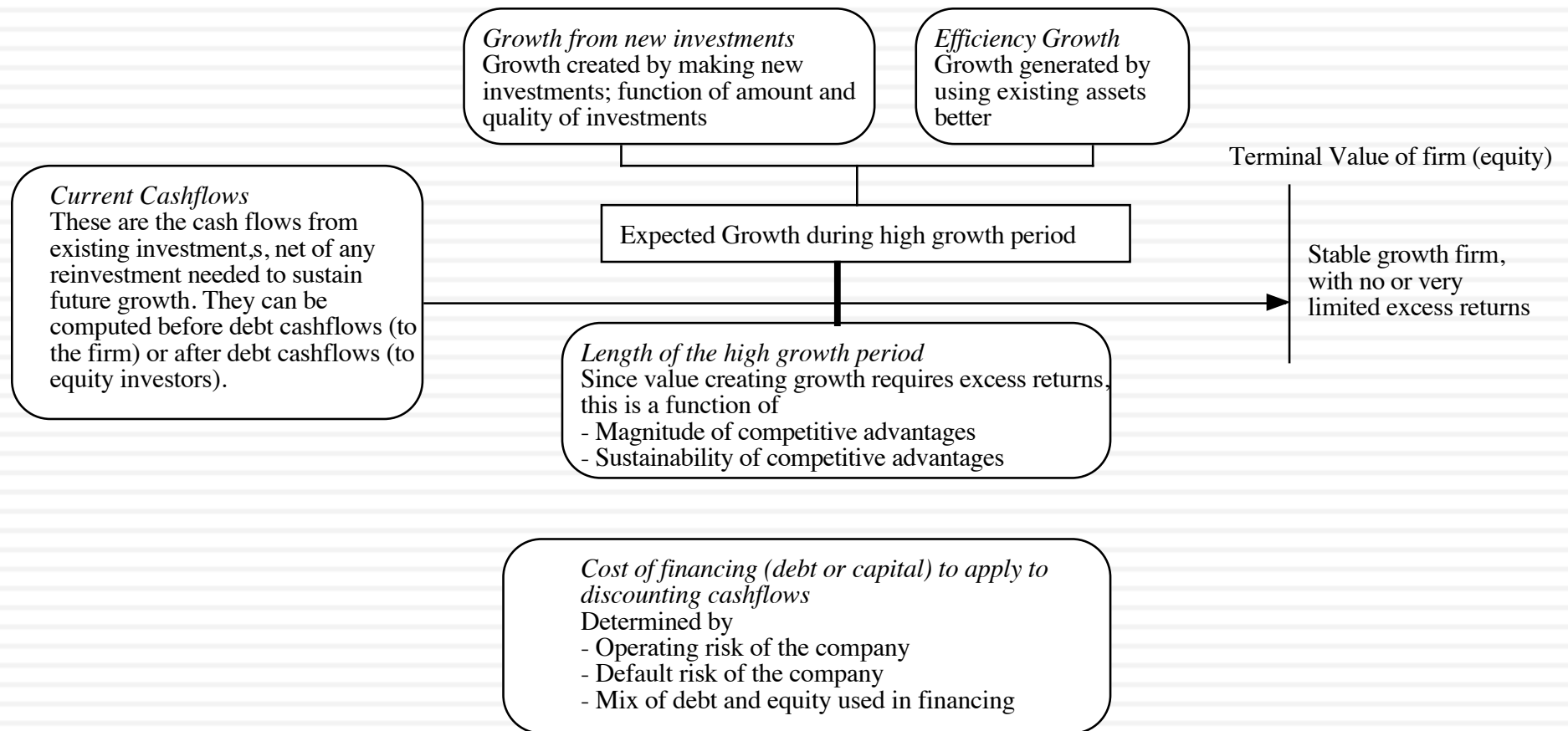

DISCOUNTED CASHFLOW VALUATION

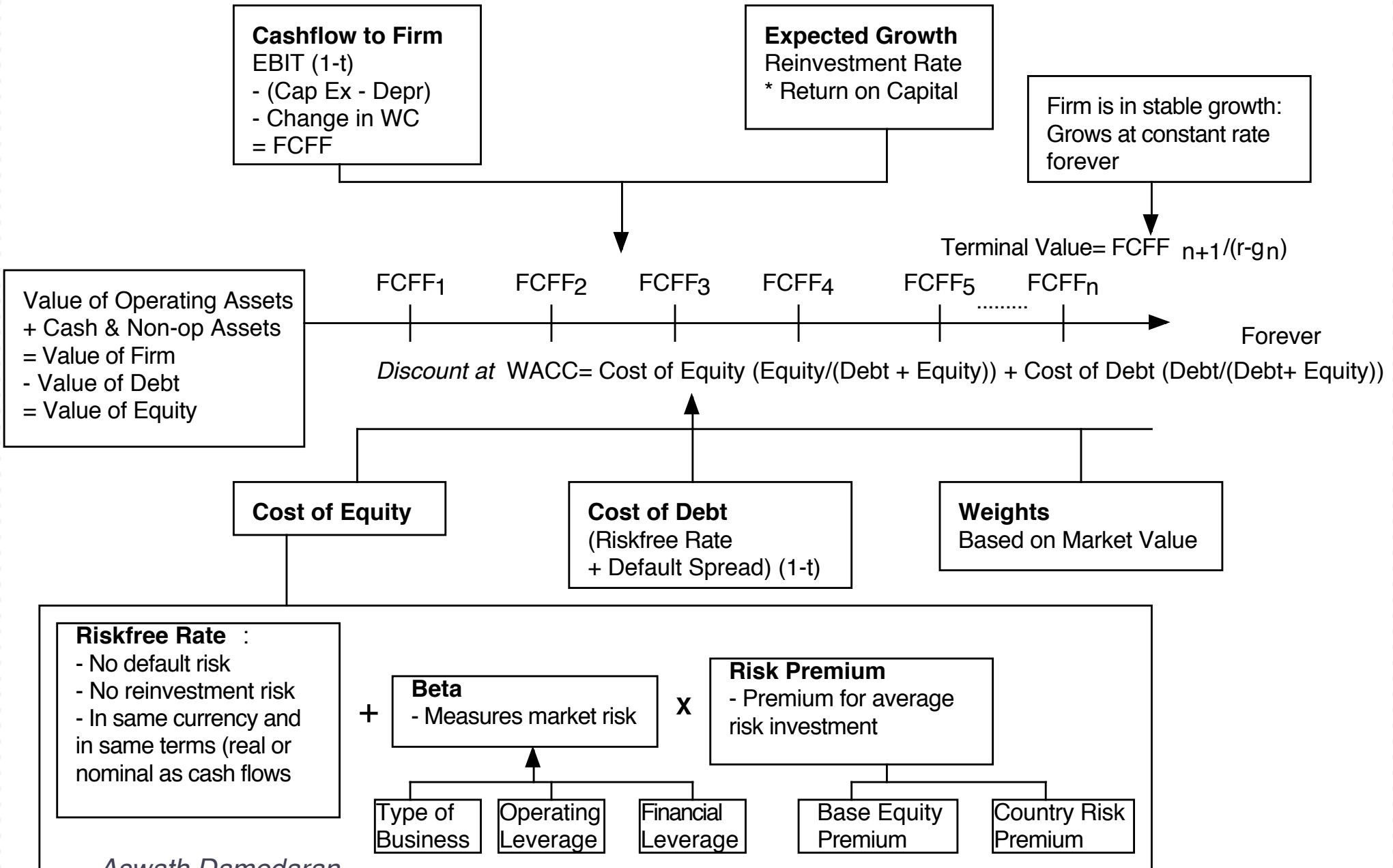

Amgen: Status Quo

Cap Ex = Acc net Cap Ex(255) + Acquisitions (3975) + R&D (2216)

Current Cashflow to Firm
 EBIT(1-t) = .7336(1-.28) = 6058
 - Nt CpX = 6443
 - Chg WC 37
 = FCFF - 423
 Reinvestment Rate = 6480/6058 = 106.98%
 Return on capital = 16.71%

Reinvestment Rate 60%

Expected Growth in EBIT (1-t)
 $.60 * .16 = .096$
9.6%

Return on Capital 16%

Stable Growth
 g = 4%; Beta = 1.10;
 Debt Ratio = 20%; Tax rate = 35%
 Cost of capital = 8.08%
 ROC = 10.00%;
 Reinvestment Rate = 4/10 = 40%

Terminal Value₁₀ = 7300 / (.0808 - .04) = 179,099

First 5 years

Growth decreases gradually to 4%

Op. Assets 94214
 + Cash: 1283
 - Debt 8272
 = Equity 87226
 - Options 479
 Value/Share \$ 74.33

Year	1	2	3	4	5	6	7	8	9	10
EBIT	\$9,221	\$10,106	\$11,076	\$12,140	\$13,305	\$14,433	\$15,496	\$16,463	\$17,306	\$17,998
EBIT (1-t)	\$6,639	\$7,276	\$7,975	\$8,741	\$9,580	\$10,392	\$11,157	\$11,853	\$12,460	\$12,958
- Reinvestment	\$3,983	\$4,366	\$4,785	\$5,244	\$5,748	\$5,820	\$5,802	\$5,690	\$5,482	\$5,183
= FCFF	\$2,656	\$2,911	\$3,190	\$3,496	\$3,832	\$4,573	\$5,355	\$6,164	\$6,978	\$7,775

Term Yr
 18718
 12167
 4867
 7300

Cost of Capital (WACC) = 11.7% (0.90) + 3.66% (0.10) = 10.90%

Debt ratio increases to 20%
 Beta decreases to 1.10

On May 1, 2007, Amgen was trading at \$ 55/share

Cost of Equity 11.70%

Cost of Debt
 $(4.78\% + .85\%)(1 - .35) = 3.66\%$

Weights
 E = 90% D = 10%

Riskfree Rate:
 Riskfree rate = 4.78%

+ **Beta 1.73** x **Risk Premium 4%**

Unlevered Beta for Sectors: 1.59

D/E = 11.06%

Tata Motors: April 2010

Average reinvestment rate
from 2005-09: 179.59%;
without acquisitions: 70%

Current Cashflow to Firm
 EBIT(1-t) : Rs 20,116
 - Nt CpX Rs 31,590
 - Chg WC Rs 2,732
 = FCFF - Rs 14,205
 Reinv Rate = (31590+2732)/20116
 = 170.61%; Tax rate = 21.00%
 Return on capital = 17.16%

Reinvestment Rate
70%

Return on Capital
17.16%

Stable Growth
g = 5%; Beta = 1.00
Country Premium = 3%
Cost of capital = 10.39%
Tax rate = 33.99%
ROC = 10.39%;
Reinvestment Rate = g/ROC
= 5%/10.39% = 48.11%

Expected Growth =
.70 * .1716 = 0.1201

Rs Cashflows Terminal Value = 23493 / (.1039 - .05) = Rs 435,686

Op. Assets 210,813
 + Cash: 11418
 + Crosshold 140576
 - Debt 109198
 = Equity 253,628
Value/Share Rs 614

Year	1	2	3	4	5	6	7	8	9	10
EBIT (1-t)	₹ 22,533	₹ 25,240	₹ 28,272	₹ 31,668	₹ 35,472	₹ 39,236	₹ 42,848	₹ 46,192	₹ 49,150	₹ 51,607
- Reinvestment	₹ 15,773	₹ 17,668	₹ 19,790	₹ 22,168	₹ 24,830	₹ 25,242	₹ 25,138	₹ 24,482	₹ 23,264	₹ 21,503
FCFF	₹ 6,760	₹ 7,572	₹ 8,482	₹ 9,500	₹ 10,642	₹ 13,994	₹ 17,711	₹ 21,710	₹ 25,886	₹ 30,104

45278
21785
23493

Discount at Cost of Capital (WACC) = 14.00% (.747) + 8.09% (0.253) = 12.50%

Growth declines to 5%
and cost of capital moves
to stable period level.

On April 1, 2010
Tata Motors price = Rs 781

Cost of Equity
14.00%

Cost of Debt
(5% + 4.25% + 3%) (1 - .3399)
= 8.09%

Weights
E = 74.7% D = 25.3%

Riskfree Rate:
Rs Riskfree Rate = 5%

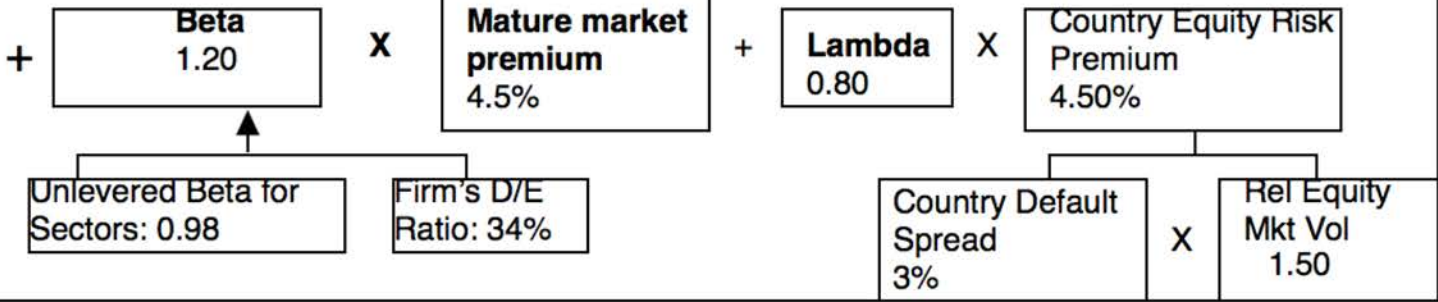

Vinamilk: May 2018 (in Vietnamese Dong)

Cash flows from existing assets

	Industry (Global data)	Vinamilk: 2017	Vinamilk: 2013-2017
Revenue growth =	7.05%	9.08%	13.99%
Pre-tax operating margin =	9.08%	22.43%	22.01%
Sales to capital ratio =	1.85	3.94	3.33
Return on invested capital =	13.99%	72.98%	60.57%

The Payoff from growth

Revenues will grow 12% a year for next 5 years, tapering down to 3.05% growth in year 10

Operating margin (pre-tax) will decline slightly to 22.01%, average from 2013-17.

Sales/Invested Capital will remain at 3.94 (from last year)

Maturity and Closure

Stable Growth $g = 3.04\%$;
 Cost of capital = 8.00%
 ROC = 8.00%;
 Reinvestment Rate = $g/ROC = 3.05\%/8.00\% = 38.125\%$

Terminal Value = $13,895 / (.08 - .0305) = 280,714$

Cashflows

	Base year	1	2	3	4	5	6	7	8	9	10	Terminal year
Revenue growth rate		12.00%	12.00%	12.00%	12.00%	12.00%	10.21%	8.42%	6.63%	4.84%	3.05%	3.05%
Revenues	51,041 đ	57,166 đ	64,026 đ	71,709 đ	80,314 đ	89,952 đ	99,136 đ	107,483 đ	114,609 đ	120,156 đ	123,821 đ	127,597 đ
EBIT (Operating) margin	22.43%	22.39%	22.35%	22.30%	22.26%	22.22%	22.17%	22.13%	22.09%	22.04%	22.00%	22.00%
EBIT (Operating income)	11,451 đ	12,800 đ	14,308 đ	15,994 đ	17,878 đ	19,985 đ	21,982 đ	23,786 đ	25,314 đ	26,487 đ	27,241 đ	28,071 đ
Tax rate	16.00%	16.00%	16.00%	16.00%	16.00%	16.00%	16.80%	17.60%	18.40%	19.20%	20.00%	20.00%
EBIT(1-t)	9,619 đ	10,752 đ	12,019 đ	13,435 đ	15,018 đ	16,787 đ	18,289 đ	19,600 đ	20,656 đ	21,401 đ	21,792 đ	22,457 đ
- Reinvestment		1,553 đ	1,740 đ	1,949 đ	2,182 đ	2,444 đ	2,329 đ	2,117 đ	1,807 đ	1,407 đ	929 đ	8,562 đ
FCFF		9,199 đ	10,279 đ	11,486 đ	12,835 đ	14,343 đ	15,960 đ	17,483 đ	18,849 đ	19,994 đ	20,863 đ	13,895 đ
Cost of capital		8.44%	8.44%	8.44%	8.44%	8.44%	8.35%	8.26%	8.18%	8.09%	8.00%	8.00%
Cumulated discount factor		0.9222	0.8504	0.7842	0.7232	0.6669	0.6155	0.5685	0.5255	0.4862	0.4502	
PV(FCFF)		8,483 đ	8,741 đ	9,008 đ	9,282 đ	9,565 đ	9,823 đ	9,939 đ	9,906 đ	9,722 đ	9,393 đ	

PV(Terminal value)	126,379.65 đ
PV (CF over next 10 years)	93,862.55 đ
Value of operating assets =	220,242.19 đ
- Debt	778.51 đ
- Minority interests	498.00 đ
+ Cash	11,471.00 đ
+ Non-operating assets	555.00 đ
Value of equity	230,991.69 đ
Number of shares	1.45
Estimated value /share	159,161.91 đ

Discount at VND Cost of Capital (WACC) = $8.44\% (.997) + 5.10\% (1-.20) (.003) = 8.44\%$

The Risk in the Cash flows

On May 1, 2018, Vinamilk was trading at 185,000 per share.

Cost of Equity
8.44%

Cost of Debt
 $3.05\% + 1.51\% + 0.54\% = 5.10\%$

Weights
 $E = 99.72\%$ $D = 0.28\%$

Riskfree Rate:
Dong Risk free Rate =
 $4.56\% - 1.51\% = 3.05\%$

Beta = 0.56

D/E Ratio: 0.28%

Business	% of Business	Unlevered Beta
Food Processing	100%	0.56

ERP = 9.68%

Country	Revenues	Weight	ERP
Vietnam	43572	85.37%	10.27%
Rest of the World	7469	14.63%	6.21%
Total	51041	100.00%	9.68%



DCF INPUTS

“Garbage in, garbage out”

I. Measure earnings right..

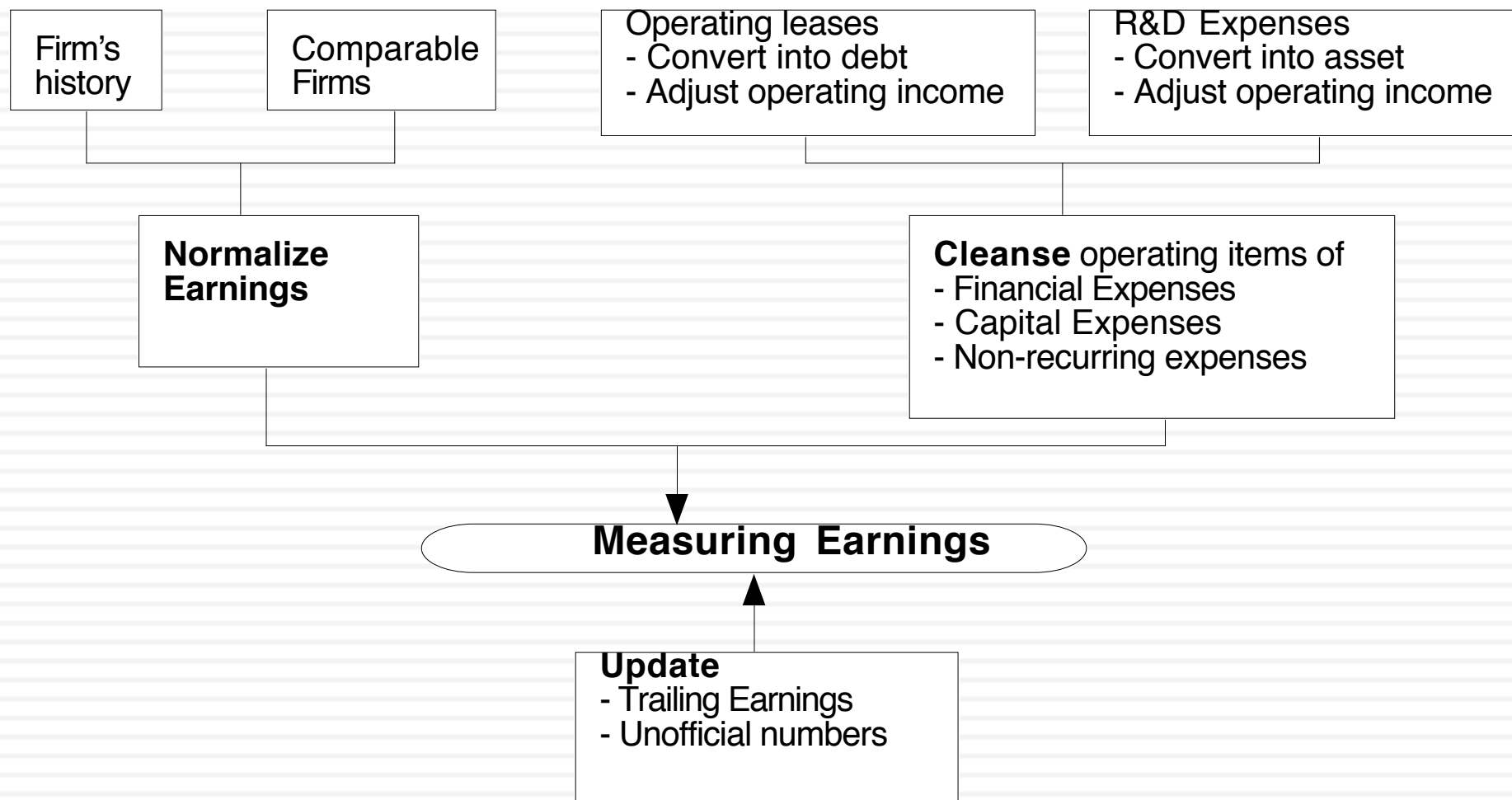

Operating Leases at Amgen in 2007

- Amgen has lease commitments and its cost of debt (based on its A rating) is 5.63%.

Year	Commitment	Present Value
1	\$96.00	\$90.88
2	\$95.00	\$85.14
3	\$102.00	\$86.54
4	\$98.00	\$78.72
5	\$87.00	\$66.16
6-12	\$107.43	\$462.10 (\$752 million prorated)

- Debt Value of leases = \$869.55
- Debt outstanding at Amgen = \$7,402 + \$ 870 = \$8,272 million
- Adjusted Operating Income = Stated OI + Lease expense this year – Depreciation
= 5,071 m + 69 m - 870/12 = \$5,068 million (12 year life for assets)
- Approximate Operating income= stated OI + PV of Lease commitment * Pre-tax cost of debt
= \$5,071 m + 870 m (.0563) = \$ 5,120 million

Capitalizing R&D Expenses: Amgen

- R & D was assumed to have a 10-year life.

Year	R&D Expense	Unamortized portion	Amortization this year	
Current	3366.00	1.00	3366.00	
-1	2314.00	0.90	2082.60	\$231.40
-2	2028.00	0.80	1622.40	\$202.80
-3	1655.00	0.70	1158.50	\$165.50
-4	1117.00	0.60	670.20	\$111.70
-5	865.00	0.50	432.50	\$86.50
-6	845.00	0.40	338.00	\$84.50
-7	823.00	0.30	246.90	\$82.30
-8	663.00	0.20	132.60	\$66.30
-9	631.00	0.10	63.10	\$63.10
-10	558.00	0.00	0.00	\$55.80
Value of Research Asset =			\$10,112.80	\$1,149.90

- Adjusted Operating Income = \$5,120 + 3,366 - 1,150 = \$7,336 million

Vinamilk: Growth and Profit Machine!

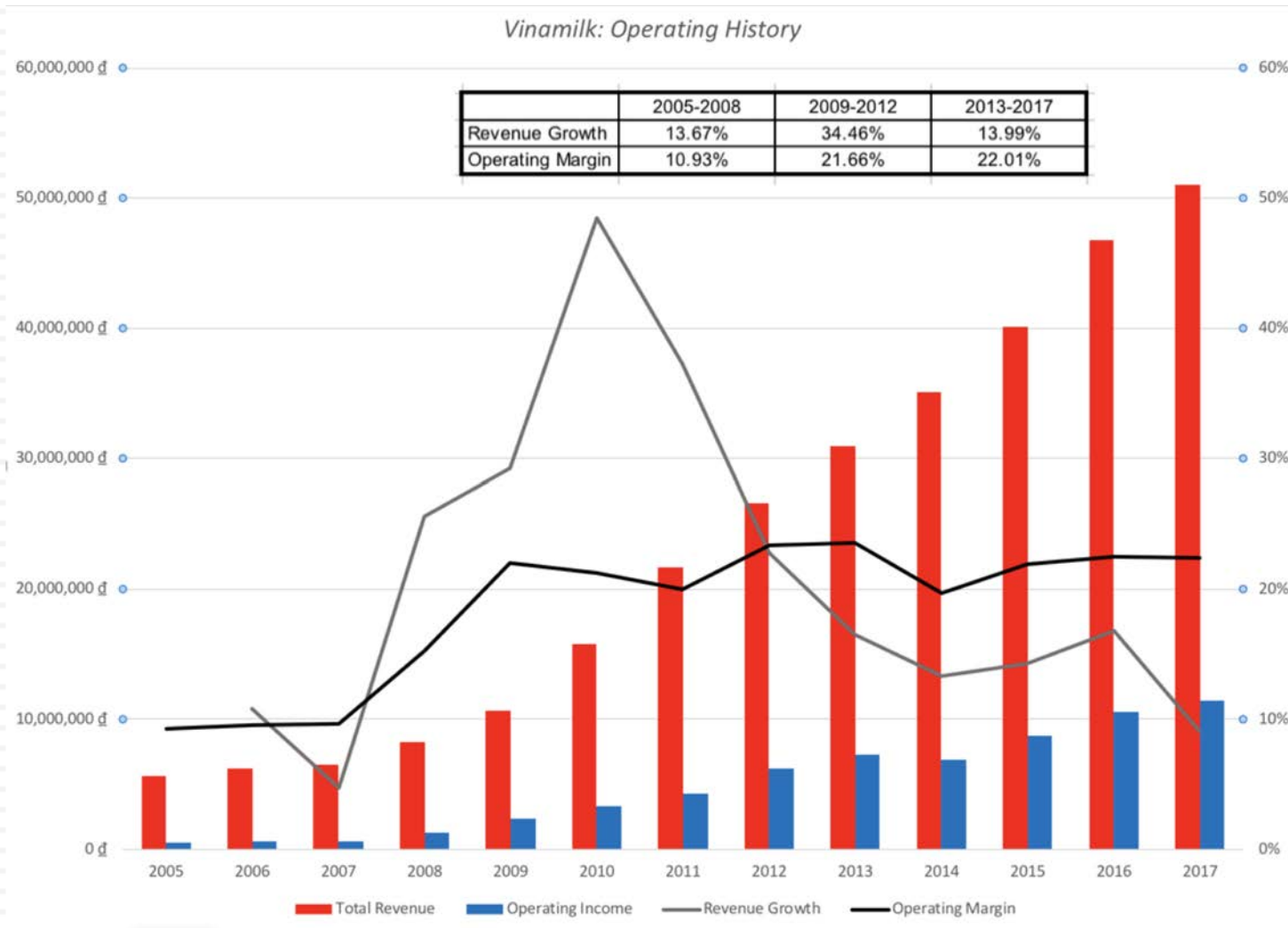

II. Get the big picture (not the accounting one) when it comes to cap ex and working capital

- Capital expenditures should include
 - ▣ Research and development expenses, once they have been re-categorized as capital expenses.
 - ▣ Acquisitions of other firms, whether paid for with cash or stock.
- Working capital should be defined not as the difference between current assets and current liabilities but as the difference between non-cash current assets and non-debt current liabilities.
- On both items, start with what the company did in the most recent year but do look at the company's history and at industry averages.

Amgen's Net Capital Expenditures

- The accounting net cap ex at Amgen is small:
 - ▣ Accounting Capital Expenditures = \$1,218 million
 - ▣ - Accounting Depreciation = \$ 963 million
 - ▣ Accounting Net Cap Ex = \$ 255 million
- We define capital expenditures broadly to include R&D and acquisitions:
 - ▣ Accounting Net Cap Ex = \$ 255 million
 - ▣ Net R&D Cap Ex = (3366-1150) = \$2,216 million
 - ▣ Acquisitions in 2006 = \$3,975 million
 - ▣ Total Net Capital Expenditures = \$ 6,443 million
- Acquisitions have been a volatile item. Amgen was quiet on the acquisition front in 2004 and 2005 and had a significant acquisition in 2003.

III. The government bond rate is not always the risk free rate

- When valuing Amgen in US dollars, the US\$ ten-year bond rate of 4.78% was used as the risk free rate. We assumed that the US treasury was default free.
- When valuing Tata Motors in Indian rupees in 2010, the Indian government bond rate of 8% was not default free. Using the Indian government's local currency rating of Ba2 yielded a default spread of 3% for India and a riskfree rate of 5% in Indian rupees.

$$\text{Risk free rate in Indian Rupees} = 8\% - 3\% = 5\%$$

- To value Vinamilk in Vietnamese Dong, you need a risk free rate in Dong. The Vietnamese government bond was yielding 4.56% on May 1, 2018. The sovereign CDS spread for Vietnam was 1.51% on May 1, 2018, yielding a riskfree rate of 3.05%.

$$\text{Riskfree rate in VND} = 4.56\% - 1.51\% = 3.05\%$$

Risk free rates will vary across currencies!

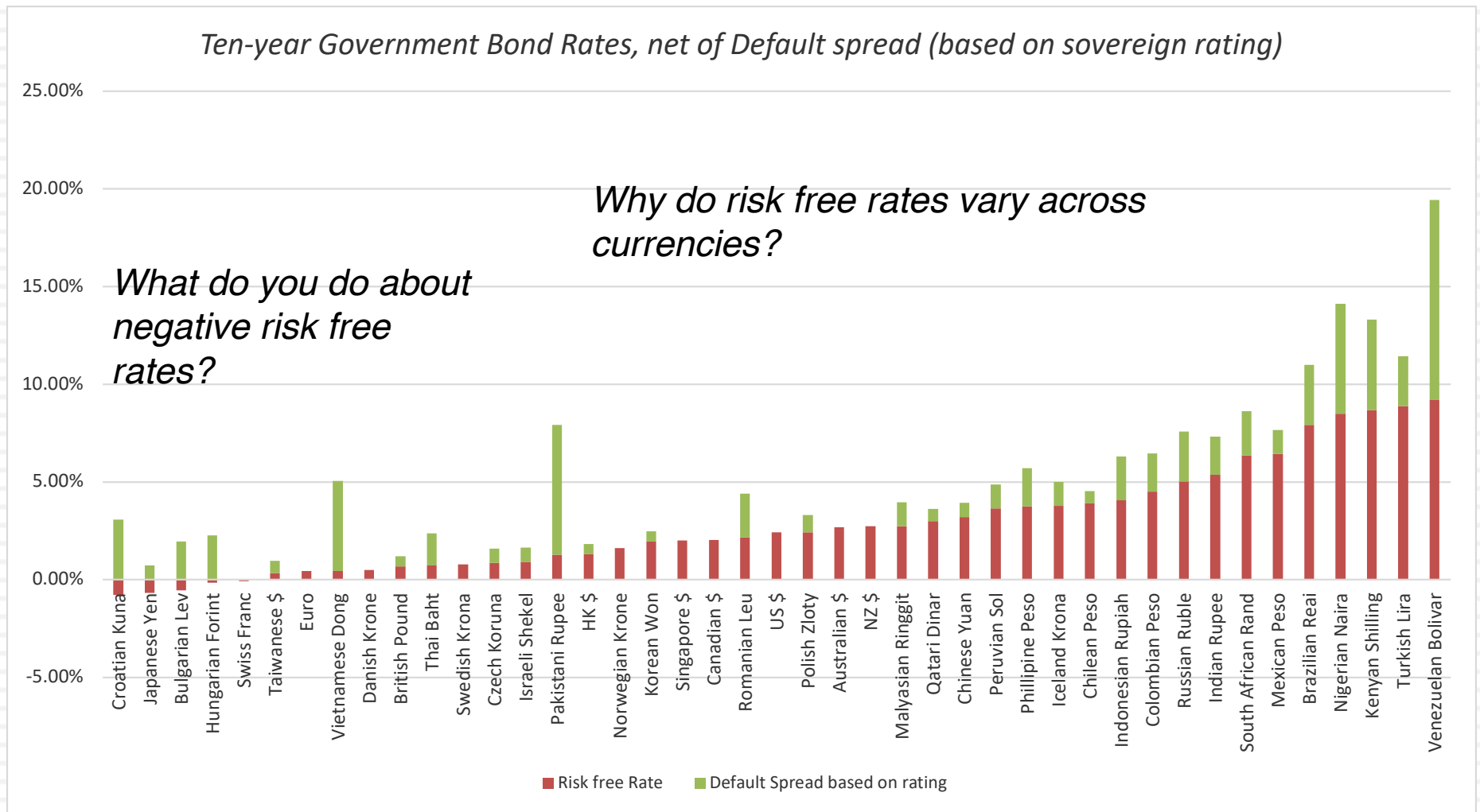

Risk free Rate: A Sanity Check

- The risk free rate in a currency is a sum of the expected inflation in the currency and a real interest rate. If you assume that the global real interest rate is a constant, the only differential between risk free rates should be the inflation differential.
- If you have the US treasury bond rate (or a German Euro bond rate), you can add the differential inflation rate between the currency and the US dollar (or Euro) to the US T.Bond rate (or Euro risk free rate) to get to a currency risk free rate.
 - $LC \text{ Risk free rate} = \text{Risk free rate in } \$ + (\text{Inflation rate in LC} - \text{Inflation rate in US } \$)$
- The expected inflation rate in the US dollar is about 2%. What is the expected inflation rate in Vietnam?

But valuations should not! Valuing Tata Motors

	In Indian Rupees	In US \$
Risk free Rate	5.00%	2.00%
Expected inflation rate	4.00%	1.00%
Cost of capital		
- High Growth	12.50%	9.25%
- Stable Growth	10.39%	7.21%
Expected growth rate		
- High Growth	12.01%	8.78%
- Stable Growth	5.00%	2.00%
Return on Capital		
- High Growth	17.16%	13.78%
- Stable Growth	10.39%	7.21%
Value per share	Rs 614	\$12.79/share (roughly Rs 614 at current exchange rate)

IV. Betas do not come from regressions... and are noisy...

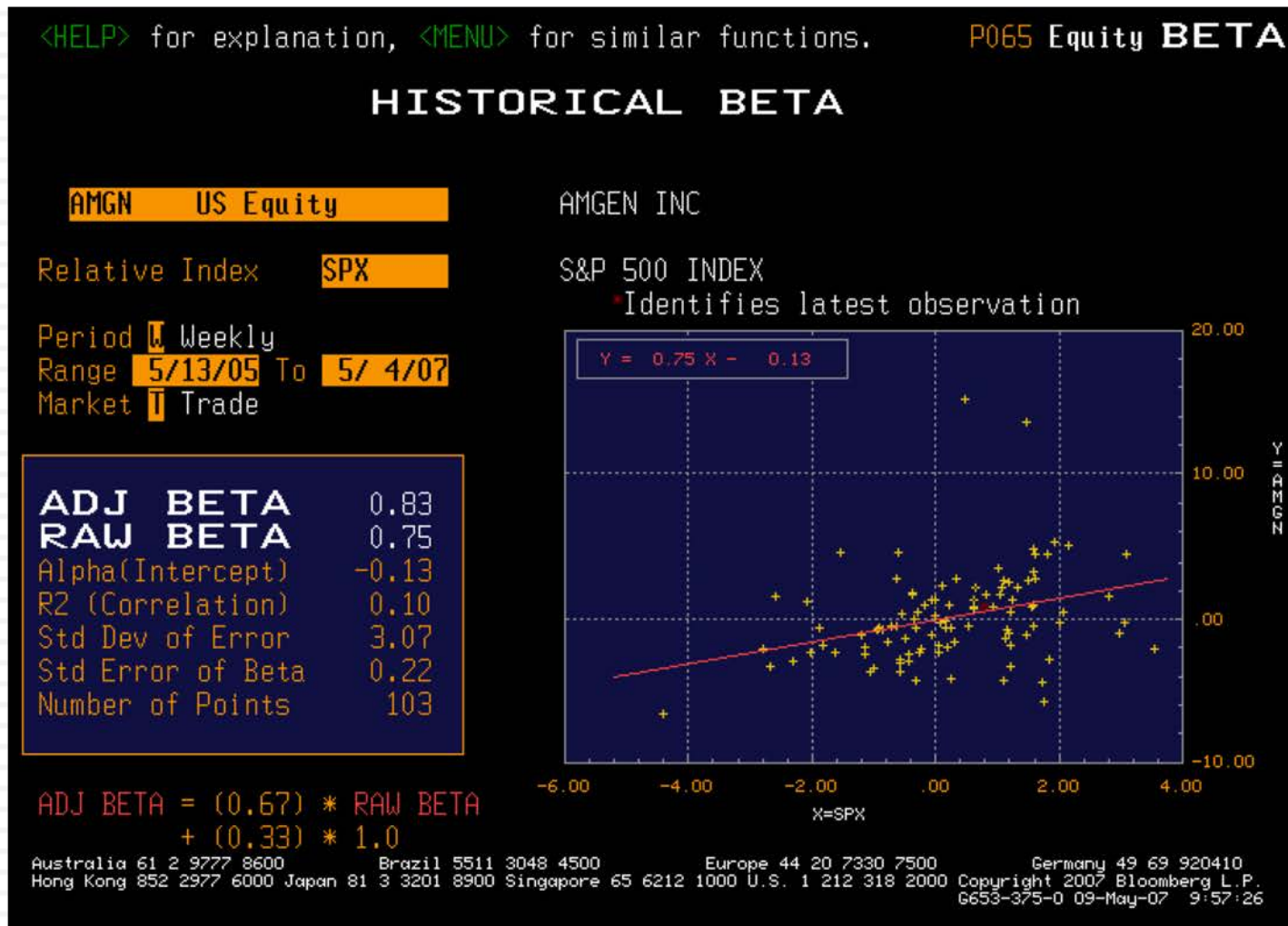

And are meaningless when run against narrow indices..

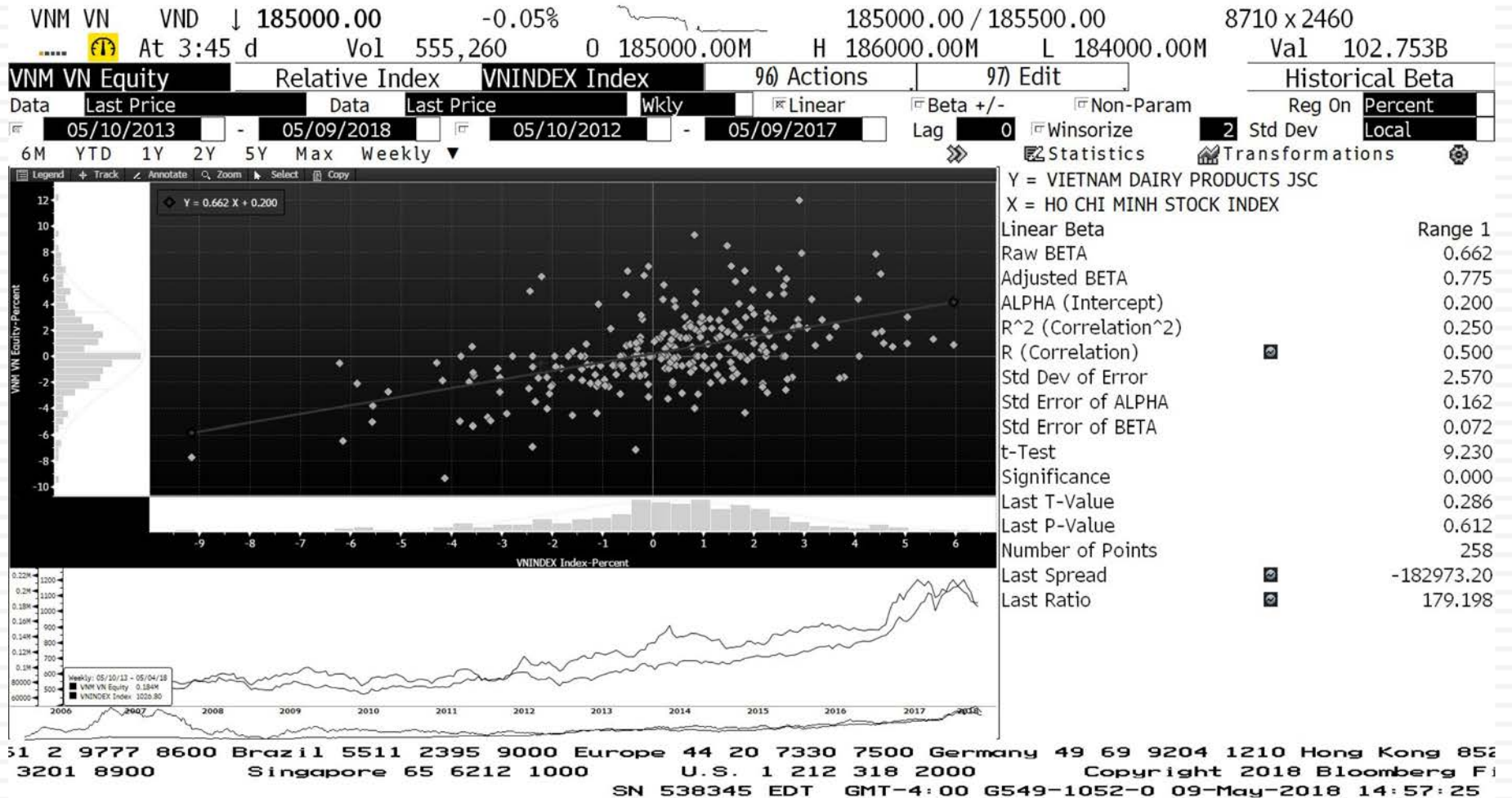

Even if they look really good...

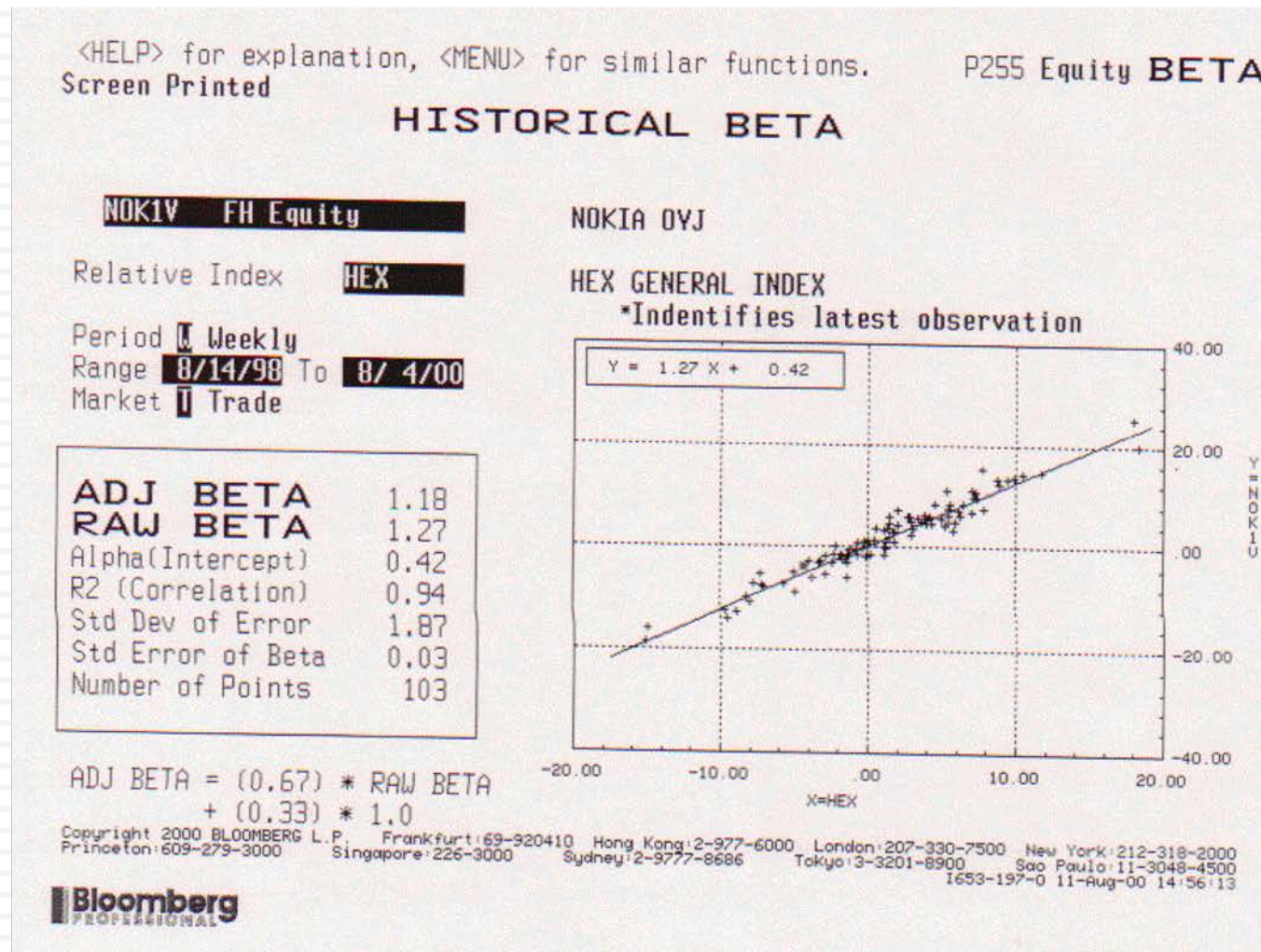

Determinants of Betas

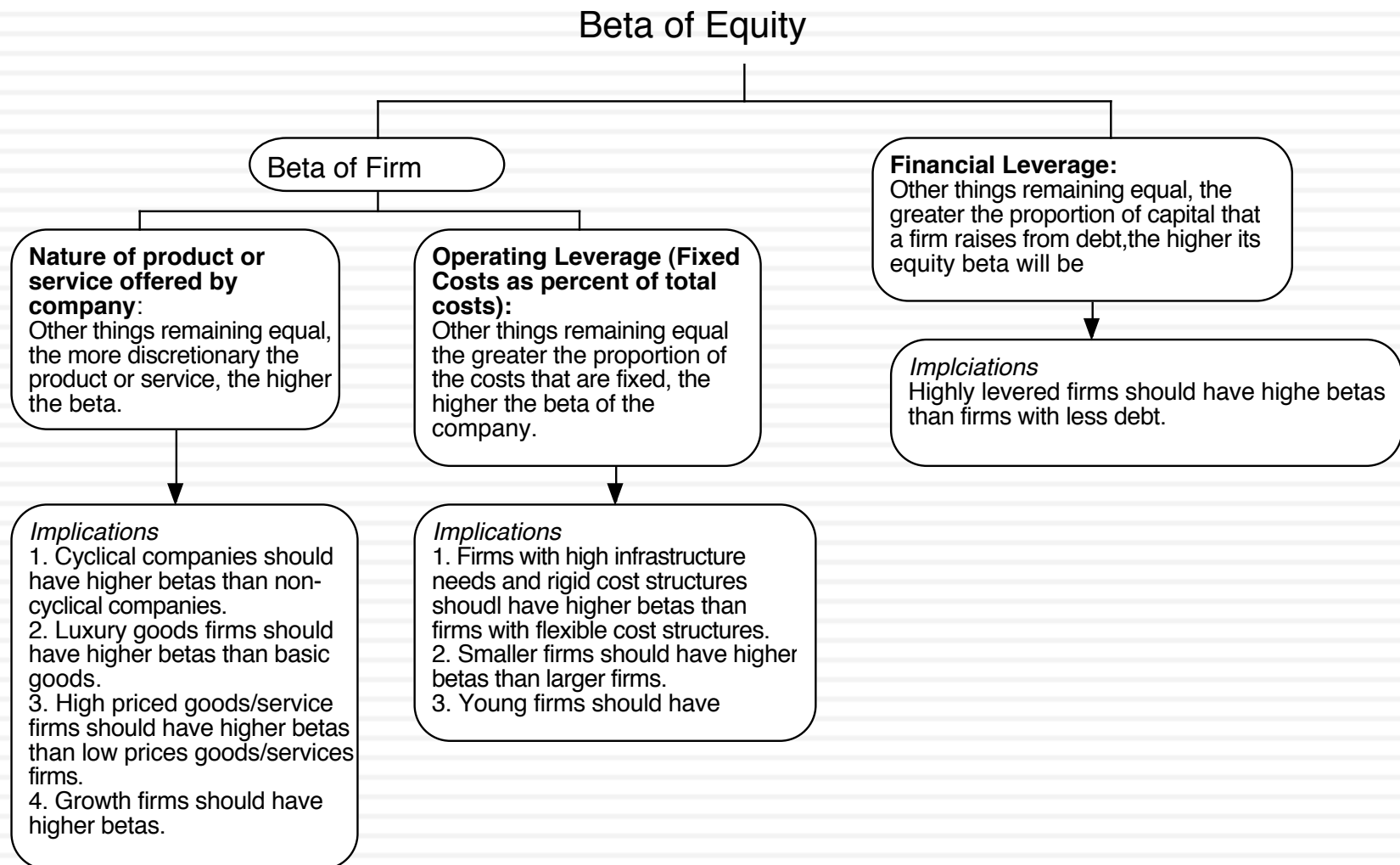

Bottom-up Betas

Step 1: Find the business or businesses that your firm operates in.

Step 2: Find publicly traded firms in each of these businesses and obtain their regression betas. Compute the simple average across these regression betas to arrive at an average beta for these publicly traded firms. Unlever this average beta using the average debt to equity ratio across the publicly traded firms in the sample.
Unlevered beta for business = $\text{Average beta across publicly traded firms} / (1 + (1-t) (\text{Average D/E ratio across firms}))$

Step 3: Estimate how much value your firm derives from each of the different businesses it is in.

Step 4: Compute a weighted average of the unlevered betas of the different businesses (from step 2) using the weights from step 3.
Bottom-up Unlevered beta for your firm = $\text{Weighted average of the unlevered betas of the individual business}$

Step 5: Compute a levered beta (equity beta) for your firm, using the market debt to equity ratio for your firm.
Levered bottom-up beta = $\text{Unlevered beta} (1 + (1-t) (\text{Debt/Equity}))$

Possible Refinements

If you can, adjust this beta for differences between your firm and the comparable firms on operating leverage and product characteristics.

While revenues or operating income are often used as weights, it is better to try to estimate the value of each business.

If you expect the business mix of your firm to change over time, you can change the weights on a year-to-year basis.

If you expect your debt to equity ratio to change over time, the levered beta will change over time.

Three examples...

- Amgen
 - The unlevered beta for pharmaceutical firms is 1.59. Using Amgen's debt to equity ratio of 11%, the bottom up beta for Amgen is
 - Bottom-up Beta = $1.59 (1 + (1-.35)(.11)) = 1.73$
- Tata Motors
 - The unlevered beta for automobile firms is 0.98. Using Tata Motor's debt to equity ratio of 33.87%, the bottom up beta for Tata Motors is
 - Bottom-up Beta = $0.98 (1 + (1-.3399)(.3387)) = 1.20$
- Vinamilk

Business	% of Business	Unlevered Beta
Food Processing	100%	0.56

$$\text{Levered Beta} = 0.56 (1 + (1-.20)(749/268,491)) = 0.56$$

Hoang Anh Gia: A More Complicated Company!

<i>Business</i>	<i>Revenues</i>	<i>EV/Sales</i>	<i>Estimated Value</i>	<i>As % of value</i>	<i>Unlevered Beta</i>
Property	782,795 đ	2.7039	2,116,574 đ	14.47%	1.2236
Production	812,004 đ	2.7039	2,195,550 đ	15.01%	1.2236
Trading and Services	672,863 đ	5.6247	3,784,682 đ	25.87%	0.6273
Construction	88,454 đ	1.6609	146,912 đ	1.00%	1.2106
Agriculture	3,522,942 đ	1.8131	6,387,406 đ	43.66%	1.0546
Company	5,879,058 đ		14,631,124 đ	100.00%	0.8112

Hoang Anh had a debt to equity ratio (in market value terms) of 429.5% in May 2018.
The levered beta for the company:

$$\text{Levered Beta} = 0.81 (1 + (1 - .20) (4.30)) = 3.60$$

V. And the past is not always a good indicator of the future.

	Arithmetic Average		Geometric Average	
	Stocks - T. Bills	Stocks - T. Bonds	Stocks - T. Bills	Stocks - T. Bonds
1928-2017	8.09%	6.38%	6.26%	4.77%
Std Error	2.10%	2.24%		
1968-2017	6.58%	4.24%	5.28%	3.29%
Std Error	2.39%	2.70%		
2008-2017	9.85%	5.98%	8.01%	4.56%
Std Error	6.12%	8.70%		

- If you are going to use a historical risk premium, make it
 - ▣ Long term (because of the standard error)
 - ▣ Consistent with your risk free rate
 - ▣ A “compounded” average
- No matter which estimate you use, recognize that it is backward looking, is noisy and may reflect selection bias.

But in the future..

36

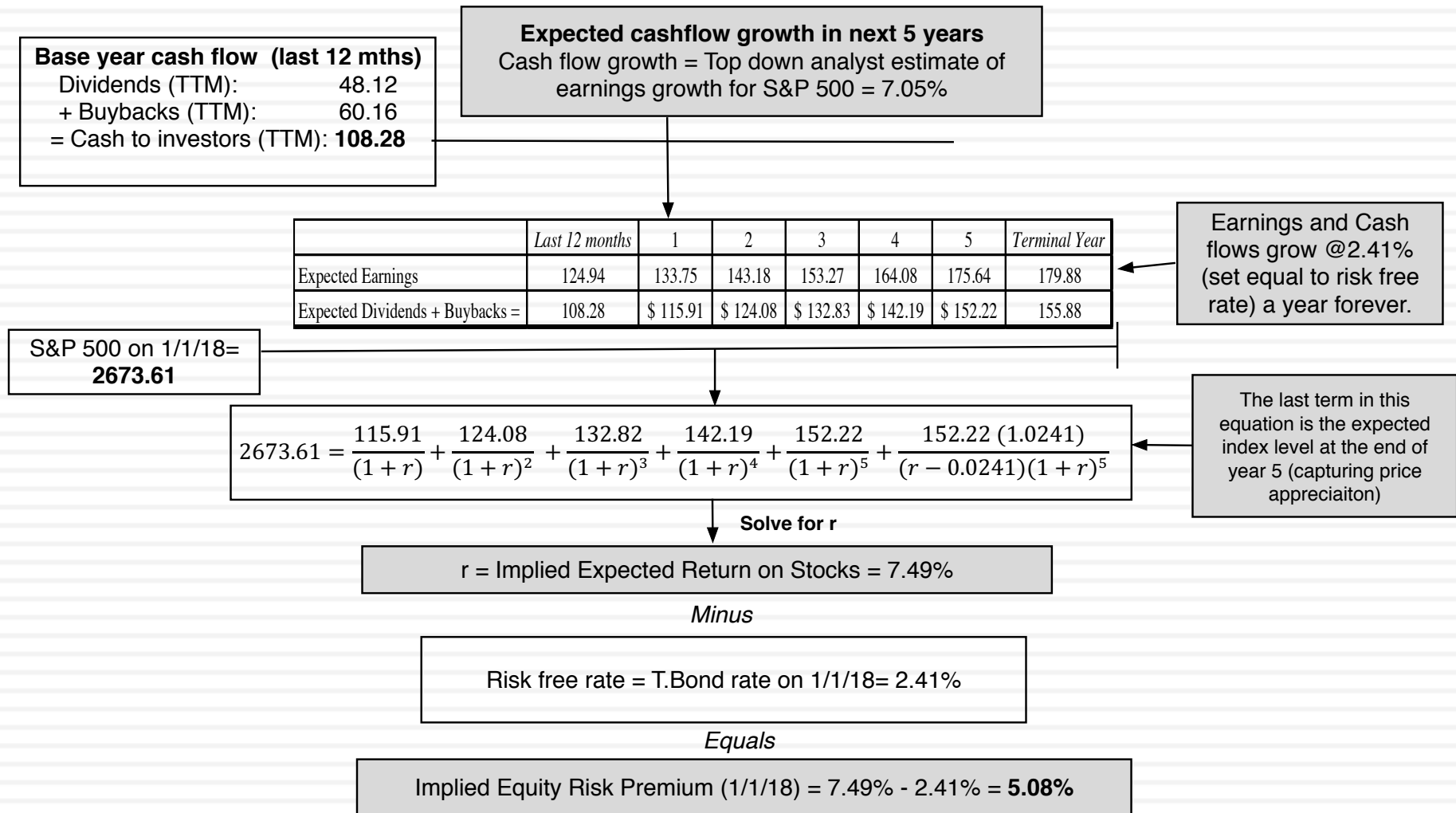

Implied Premiums in the US: 1960-2017

Implied Premium for US Equity Market: 1960-2017

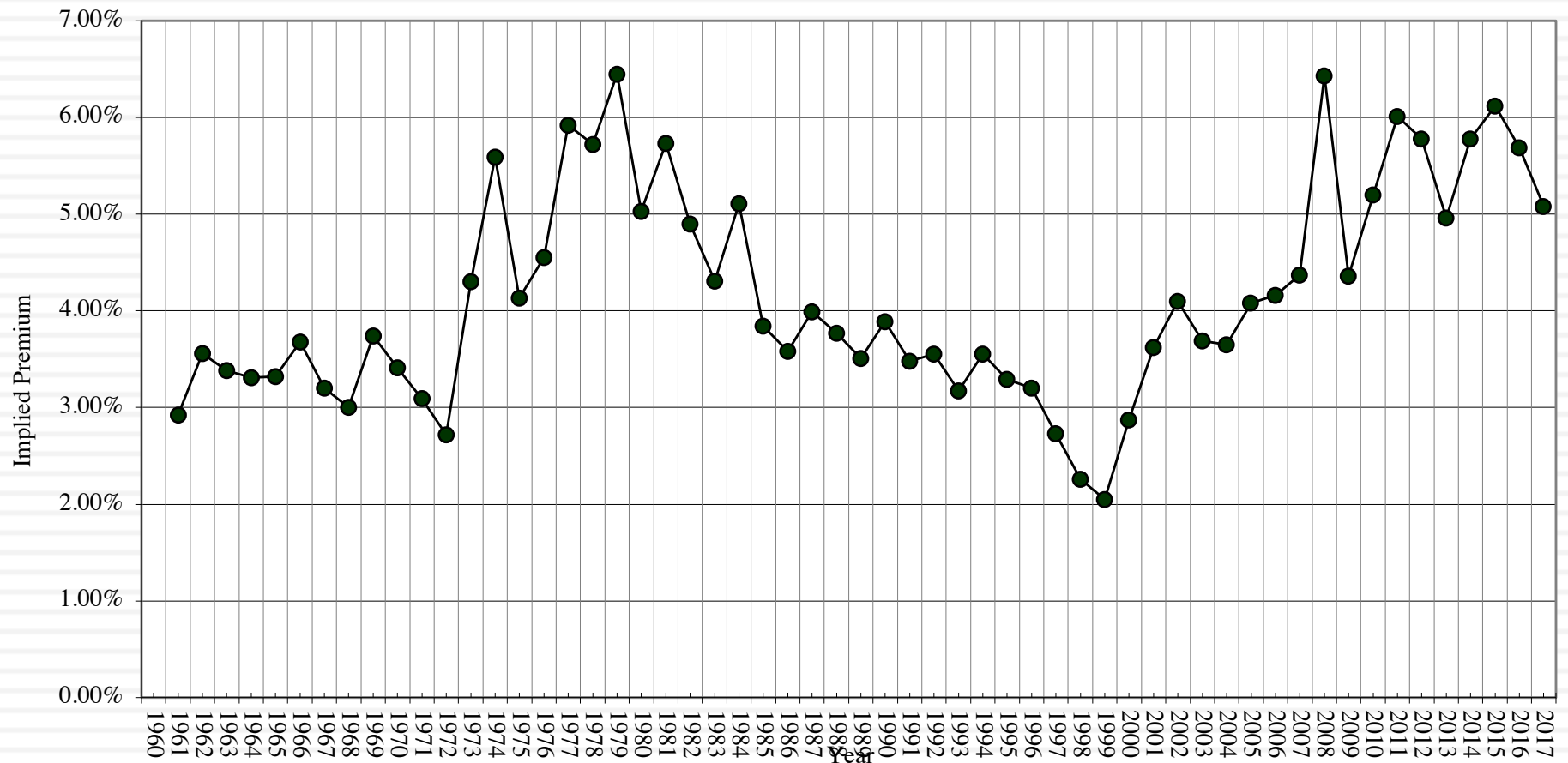

The Anatomy of a Crisis: Implied ERP from September 12, 2008 to January 1, 2009

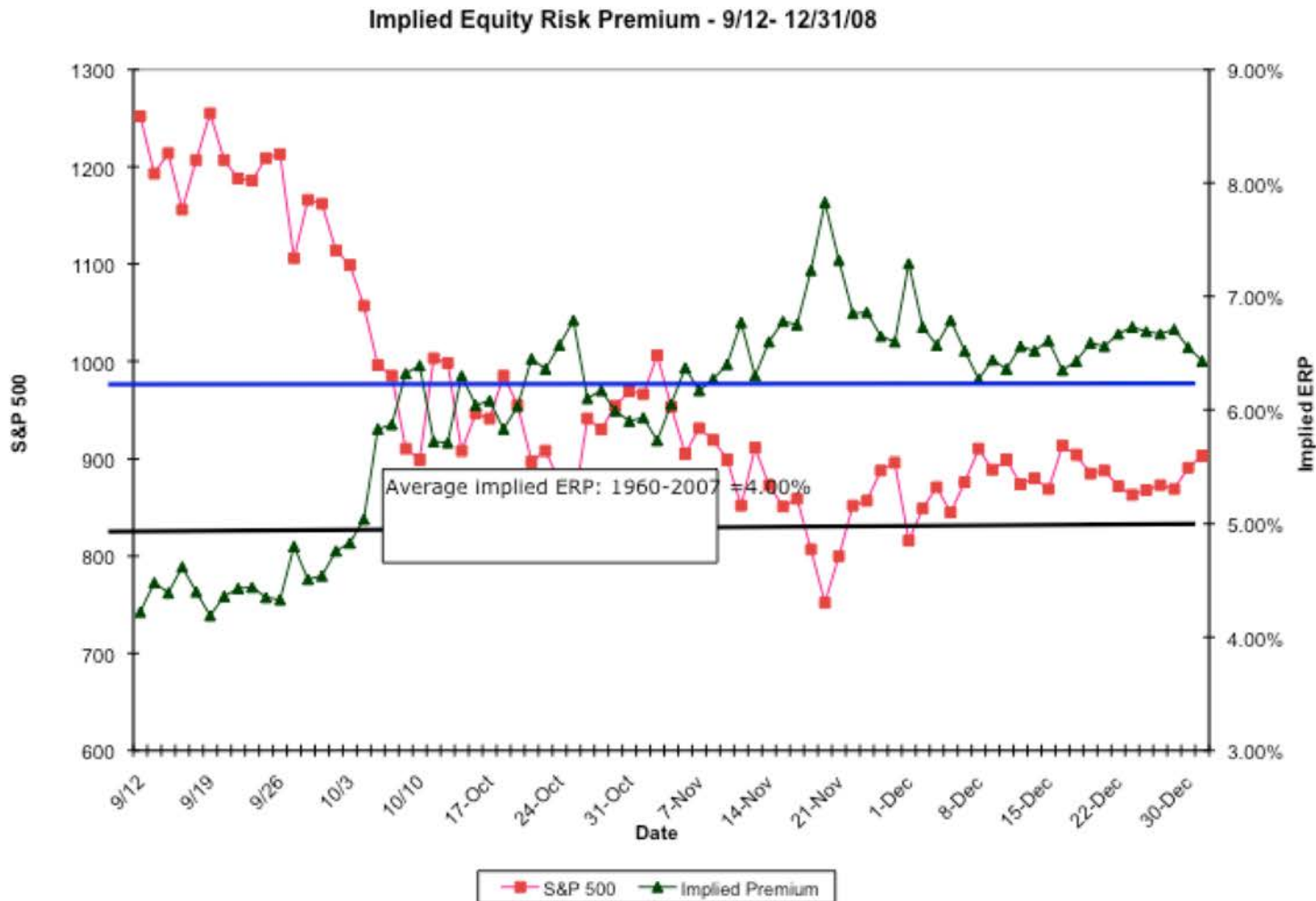

Implied Premium for India using the Sensex: April 2010

- Level of the Index = 17559
- FCFE on the Index = 3.5% (Estimated FCFE for companies in index as % of market value of equity)
- Other parameters
 - Riskfree Rate = 5% (Rupee)
 - Expected Growth (in Rupee)
 - Next 5 years = 20% (Used expected growth rate in Earnings)
 - After year 5 = 5%
- Solving for the expected return:
 - Expected return on Equity = 11.72%
 - Implied Equity premium for India = $11.72\% - 5\% = 6.72\%$

Emerging versus Developed Markets: Implied Equity Risk Premiums

$$PBV = \frac{(Return\ on\ equity - Expected\ growth\ rate)}{(Cost\ of\ equity - Expected\ growth\ rate)}$$

$$Cost\ of\ Equity = \frac{(ROE - Expected\ growth\ rate)}{PBV} + Expected\ growth\ rate$$

Start of year	PBV Developed	PBV Emerging	ROE Developed	ROE Emerging	US T.Bond rate	Growth Rate Developed	Growth Rate Emerging	Cost of Equity (Developed)	Cost of Equity (Emerging)	Differential ERP
2004	2.00	1.19	10.81%	11.65%	4.25%	3.75%	5.25%	7.28%	10.63%	3.35%
2005	2.09	1.27	11.12%	11.93%	4.22%	3.72%	5.22%	7.26%	10.50%	3.24%
2006	2.03	1.44	11.32%	12.18%	4.39%	3.89%	5.39%	7.55%	10.11%	2.56%
2007	1.67	1.67	10.87%	12.88%	4.70%	4.20%	5.70%	8.19%	10.00%	1.81%
2008	0.87	0.83	9.42%	11.12%	4.02%	3.52%	5.02%	10.30%	12.37%	2.07%
2009	1.20	1.34	8.48%	11.02%	2.21%	1.71%	3.21%	7.35%	9.04%	1.69%
2010	1.39	1.43	9.14%	11.22%	3.84%	3.34%	4.84%	7.51%	9.30%	1.79%
2011	1.12	1.08	9.21%	10.04%	3.29%	2.79%	4.29%	8.52%	9.61%	1.09%
2012	1.17	1.18	9.10%	9.33%	1.88%	1.38%	2.88%	7.98%	8.35%	0.37%
2013	1.56	1.63	8.67%	10.48%	1.76%	1.26%	2.76%	6.02%	7.50%	1.48%
2014	1.95	1.50	9.27%	9.64%	3.04%	2.54%	4.04%	6.00%	7.77%	1.77%
2015	1.88	1.56	9.69%	9.75%	2.17%	1.67%	3.17%	5.94%	7.39%	1.45%
2016	1.89	1.59	9.24%	10.16%	2.27%	1.77%	3.27%	5.72%	7.60%	1.88%

VI. The Downside of Globalization: Dealing with Country Risk

- The Default Spread: Most practitioners estimate the equity risk premium for riskier markets by starting with a base premium for a mature market and adding the default spread for the government in the risky market.

ERP for country = ERP for Mature Market + Default spread for country

ERP for India = ERP for US + Default Spread for Thailand

$$= 5.08\% + 1.64\% = 6.72\%$$

- The Melded Default Spread: Equities are riskier than bonds and scaling up the default spread for the higher risk in equities should yield a better estimate of the additional risk for a country:

ERP for country = ERP for Mature Market + Default spread for country * (Std Deviation of Equity_{Country} / Std Deviation of Govt Bond_{Country})

ERP for Vietnam = 5.08% + 4.62% (14.88%/12.55%) = 10.56%

A Template for Estimating the ERP

ERP Estimation Procedure

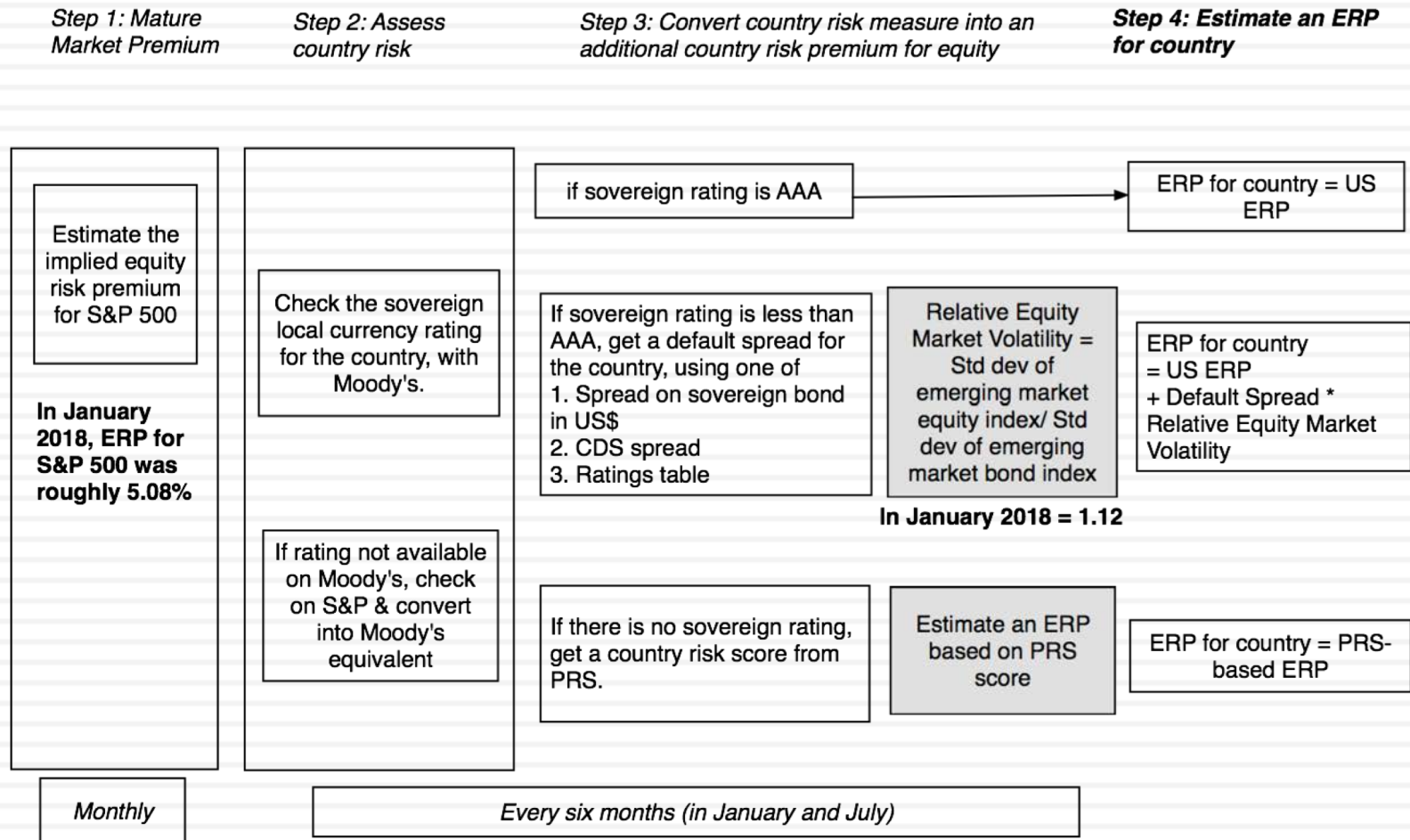

Andorra	Baa2	7.27%	2.19%	Jersey	Aa3	5.78%	0.70%
Austria	Aa1	5.54%	0.46%	Liechtenstein	Aaa	5.08%	0.00%
Belgium	Aa3	5.78%	0.70%	Luxembourg	Aaa	5.08%	0.00%
Cyprus	Ba3	9.23%	4.15%	Malta	A3	6.46%	1.38%
Denmark	Aaa	5.08%	0.00%	Netherlands	Aaa	5.08%	0.00%
Finland	Aa1	5.54%	0.46%	Norway	Aaa	5.08%	0.00%
France	Aa2	5.65%	0.57%	Portugal	Ba1	7.96%	2.88%
Germany	Aaa	5.08%	0.00%	Spain	Baa2	7.27%	2.19%
Greece	Caa2	15.46%	10.38%	Sweden	Aaa	5.08%	0.00%
Guernsey	Aa3	5.78%	0.70%	Switzerland	Aaa	5.08%	0.00%
Iceland	A3	6.46%	1.38%	Turkey	Ba1	7.96%	2.88%
Ireland	A2	6.06%	0.98%	United Kingdom	Aa2	5.65%	0.57%
Isle of Man	Aa2	5.65%	0.57%	Western Europe		6.01%	0.93%
Italy	Baa2	7.27%	2.19%				

Canada	Aaa	5.08%	0.00%
United States	Aaa	5.08%	0.00%
North America		5.08%	0.00%

Caribbean		11.39%	6.31%
------------------	--	--------	-------

Argentina	B2	11.42%	6.34%
Belize	B3	12.58%	7.50%
Bolivia	Ba3	9.23%	4.15%
Brazil	Ba2	8.54%	3.46%
Chile	Aa3	5.78%	0.70%
Colombia	Baa2	7.27%	2.19%
Costa Rica	Ba2	8.54%	3.46%
Ecuador	B3	12.58%	7.50%
El Salvador	Caa1	13.72%	8.64%
Guatemala	Ba1	7.96%	2.88%
Honduras	B1	10.27%	5.19%
Mexico	A3	6.46%	1.38%
Nicaragua	B2	11.42%	6.34%
Panama	Baa2	7.27%	2.19%
Paraguay	Ba1	7.96%	2.88%
Peru	A3	6.46%	1.38%
Suriname	B1	10.27%	5.19%
Uruguay	Baa2	7.27%	2.19%
Venezuela	Caa3	16.60%	11.52%
Latin America		8.63%	3.55%

Angola		11.42%	6.34%
Botswana		6.06%	0.98%
Burkina Faso		11.42%	6.34%
Cameroon		11.42%	6.34%
Cape Verde		11.42%	6.34%
Congo (DR)		12.58%	7.50%
Congo (Rep of)		15.46%	10.38%
Côte d'Ivoire		9.23%	4.15%
Egypt		12.58%	7.50%
Ethiopia		10.27%	5.19%
Gabon		12.58%	7.50%
Ghana		12.58%	7.50%
Kenya		10.27%	5.19%
Morocco		7.96%	2.88%
Mozambique		16.60%	11.52%
Namibia		7.96%	2.88%
Nigeria		11.42%	6.34%
Rwanda		11.42%	6.34%
Senegal		9.23%	4.15%
South Africa		7.62%	2.54%
Swaziland		5.08%	11.42%
Tunisia		10.27%	5.19%
Uganda		11.42%	6.34%
Zambia		12.58%	7.50%
Africa		10.63%	5.58%

Albania	B1	10.27%	5.19%
Armenia	B1	10.27%	5.19%
Azerbaijan	Ba2	8.54%	3.46%
Belarus	Caa1	13.72%	8.64%
Bosnia	B3	12.58%	7.50%
Bulgaria	Baa2	7.27%	2.19%
Croatia	Ba2	8.54%	3.46%
Czech Republic	A1	5.89%	0.81%
Estonia	A1	5.89%	0.81%
Georgia	Ba2	8.54%	3.46%
Hungary	Baa3	7.62%	2.54%
Kazakhstan	Baa3	7.62%	2.54%
Kyrgyzstan	B2	11.42%	6.34%
Latvia	A3	6.46%	1.38%
Lithuania	A3	6.46%	1.38%
Macedonia	Ba3	9.23%	4.15%
Moldova	B3	12.58%	7.50%
Montenegro	B1	10.27%	5.19%
Poland	A2	6.06%	0.98%
Romania	Baa3	7.62%	2.54%
Russia	Ba1	7.96%	2.88%
Serbia	Ba3	9.23%	4.15%
Slovakia	A2	6.06%	0.98%
Slovenia	Baa1	6.92%	1.84%
Tajikistan	B3	7.96%	2.88%
Ukraine	Caa2	15.46%	10.38%
E. Europe		7.75%	2.69%

Abu Dhabi	Aa2	5.65%	0.57%
Bahrain	B1	10.27%	5.19%
Iraq	Caa1	13.72%	8.64%
Israel	A1	5.89%	0.81%
Jordan	B1	10.27%	5.19%
Kuwait	Aa2	5.65%	0.57%
Lebanon	B3	12.58%	7.50%
Oman	Baa2	7.27%	2.19%
Qatar	Aa3	5.78%	0.70%
Ras Al Khaimah	A2	6.06%	0.98%
Saudi Arabia	A1	5.89%	0.81%
Sharjah	A3	6.46%	1.38%
United Arab Emirates	Aa2	5.65%	0.57%
Middle East		6.69%	1.61%

Country	PRS	ERP	CRP	Country	PRS	ERP	CRP
Algeria	62.3	12.58%	7.50%	Malawi	61.3	13.73%	8.65%
Brunei	76.3	6.06%	0.98%	Mali	60.8	13.73%	8.65%
Gambia	59.3	15.46%	10.38%	Myanmar	63.8	12.58%	7.50%
Guinea	58.3	15.46%	10.38%	Niger	53.7	18.91%	13.83%
Guinea-Bissau	63.8	12.58%	7.50%	Sierra Leone	54.3	18.91%	13.83%
Guyana	68.5	9.23%	4.15%	Somalia	52	18.91%	13.83%
Haiti	61.8	13.73%	8.65%	Sudan	48	25.32%	20.24%
Iran	73.3	7.27%	2.19%	Syria	47	25.32%	20.24%
Korea, D.P.R.	56	16.60%	11.52%	Tanzania	63.3	12.58%	7.50%
Liberia	53	18.91%	13.83%	Togo	61	13.73%	8.65%
Libya	62	13.73%	8.65%	Yemen, Republic	49.3	25.32%	20.24%
Madagascar	64.5	11.42%	6.34%	Zimbabwe	58.5	15.46%	10.38%

Bangladesh	Ba3	9.23%	4.15%
Cambodia	B2	11.42%	6.34%
China	A1	5.89%	0.81%
Fiji	Ba3	9.23%	4.15%
Hong Kong	Aa2	5.65%	0.57%
India	Baa2	7.27%	2.19%
Indonesia	Baa3	7.62%	2.54%
Japan	A1	5.89%	0.81%
Korea	Aa2	5.65%	0.57%
Macao	Aa3	5.78%	0.70%
Malaysia	A3	6.46%	1.38%
Mauritius	Baa1	6.92%	1.84%
Mongolia	Caa1	13.72%	8.64%
Pakistan	B3	12.58%	7.50%
Papua New Guinea	B2	11.42%	6.34%
Philippines	Baa2	7.27%	2.19%
Singapore	Aaa	5.08%	0.00%
Sri Lanka	B1	10.27%	5.19%
Taiwan	Aa3	5.78%	0.70%
Thailand	Baa1	6.92%	1.84%
Vietnam	B1	10.27%	5.19%
Asia		6.27%	1.19%

Australia	Aaa	5.08%	0.00%
Cook Islands	B1	10.27%	5.19%
New Zealand	Aaa	5.08%	0.00%
Australia & New Zealand		5.08%	0.00%

Red #: Country risk premium
Regional #: GDP weighted average

VII. And it is not just emerging market companies that are exposed to this risk..

- The “default” approach in valuation has been to assign country risk based upon your country of incorporation. Thus, if you are incorporated in a developed market, the assumption has been that you are not exposed to emerging market risks. If you are incorporated in an emerging market, you are saddled with the entire country risk.
- As companies globalize and look for revenues in foreign markets, this practice will under estimate the costs of equity of developed market companies with significant emerging market risk exposure and over estimate the costs of equity of emerging market companies with significant developed market risk exposure.

One way of dealing with this: Operation-based ERP for Vinamilk

<i>Country</i>	<i>Revenues</i>	<i>Weight</i>	<i>ERP</i>
Vietnam	43572	85.37%	10.27%
Rest of the World	7469	14.63%	6.21%
Total	51041	100.00%	9.68%

1. By focusing on revenues, are we misestimating country risk exposure?
2. As the company looks to grow in other parts of the world, how do you see this premium evolving?

Natural Resource Twists? Royal Dutch

<i>Country</i>	<i>Oil & Gas Production</i>	<i>% of Total</i>	<i>ERP</i>
Denmark	17396	3.83%	6.20%
Italy	11179	2.46%	9.14%
Norway	14337	3.16%	6.20%
UK	20762	4.57%	6.81%
<i>Rest of Europe</i>	<i>874</i>	<i>0.19%</i>	<i>7.40%</i>
Brunei	823	0.18%	9.04%
Iraq	20009	4.40%	11.37%
Malaysia	22980	5.06%	8.05%
Oman	78404	17.26%	7.29%
Russia	22016	4.85%	10.06%
<i>Rest of Asia & ME</i>	<i>24480</i>	<i>5.39%</i>	<i>7.74%</i>
<i>Oceania</i>	<i>7858</i>	<i>1.73%</i>	<i>6.20%</i>
Gabon	12472	2.75%	11.76%
Nigeria	67832	14.93%	11.76%
Rest of Africa	6159	1.36%	12.17%
USA	104263	22.95%	6.20%
Canada	8599	1.89%	6.20%
Brazil	13307	2.93%	9.60%
<i>Rest of Latin America</i>	<i>576</i>	<i>0.13%</i>	<i>10.78%</i>
Royal Dutch Shell	454326	100.00%	8.26%

An alternate way: Estimating a company's exposure to country risk (Lambda)

□ Just as beta measures exposure to macro economic risk, lambda measures exposure just to country risk. Like beta, it is scaled around one.

□ The easiest and most accessible data is on revenues. Most companies break their revenues down by region. One simplistic solution would be to do the following:

$$\text{Lambda} = \% \text{ of revenues domestically}_{\text{firm}} / \% \text{ of revenues domestically}_{\text{average firm}}$$

□ In 2008-09, Tata Motors got about 91.37% of its revenues in India and TCS got 7.62%. The average Indian firm gets about 80% of its revenues in India:

□ $\text{Lambda}_{\text{Tata Motors}} = 91\%/80\% = 1.14$

□ The danger of focusing just on revenues is that it misses other exposures to risk (production and operations).

	<i>Tata Motors</i>	<i>TCS</i>
% of production/operations in India	High	High
% of revenues in India	91.37% (in 2009) Estimated 70% (in 2010)	7.62%
Lambda	0.80	0.20
Flexibility in moving operations	Low. Significant physical assets.	High. Human capital is mobile.

VIII. Growth has to be earned (not endowed or estimated): Sustainable Growth

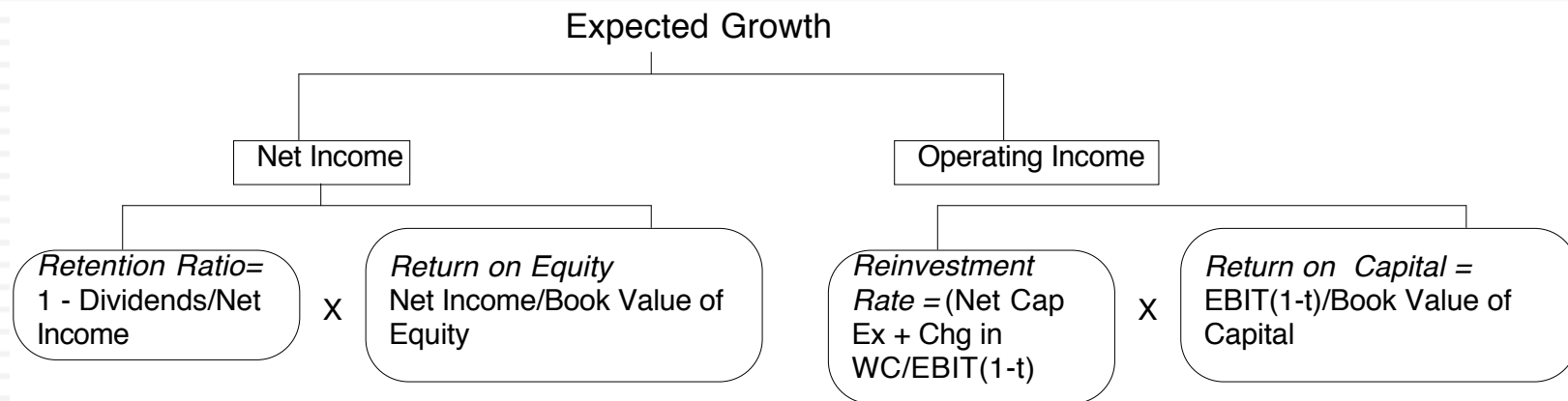

1. No free growth: In the long term, to grow, you have to reinvest.
2. Growth Quality: For a given reinvestment, the higher the return you generate on your reinvestment, the faster you can grow.
3. Scaling up is hard to do.

Measuring Returns: The Quandary

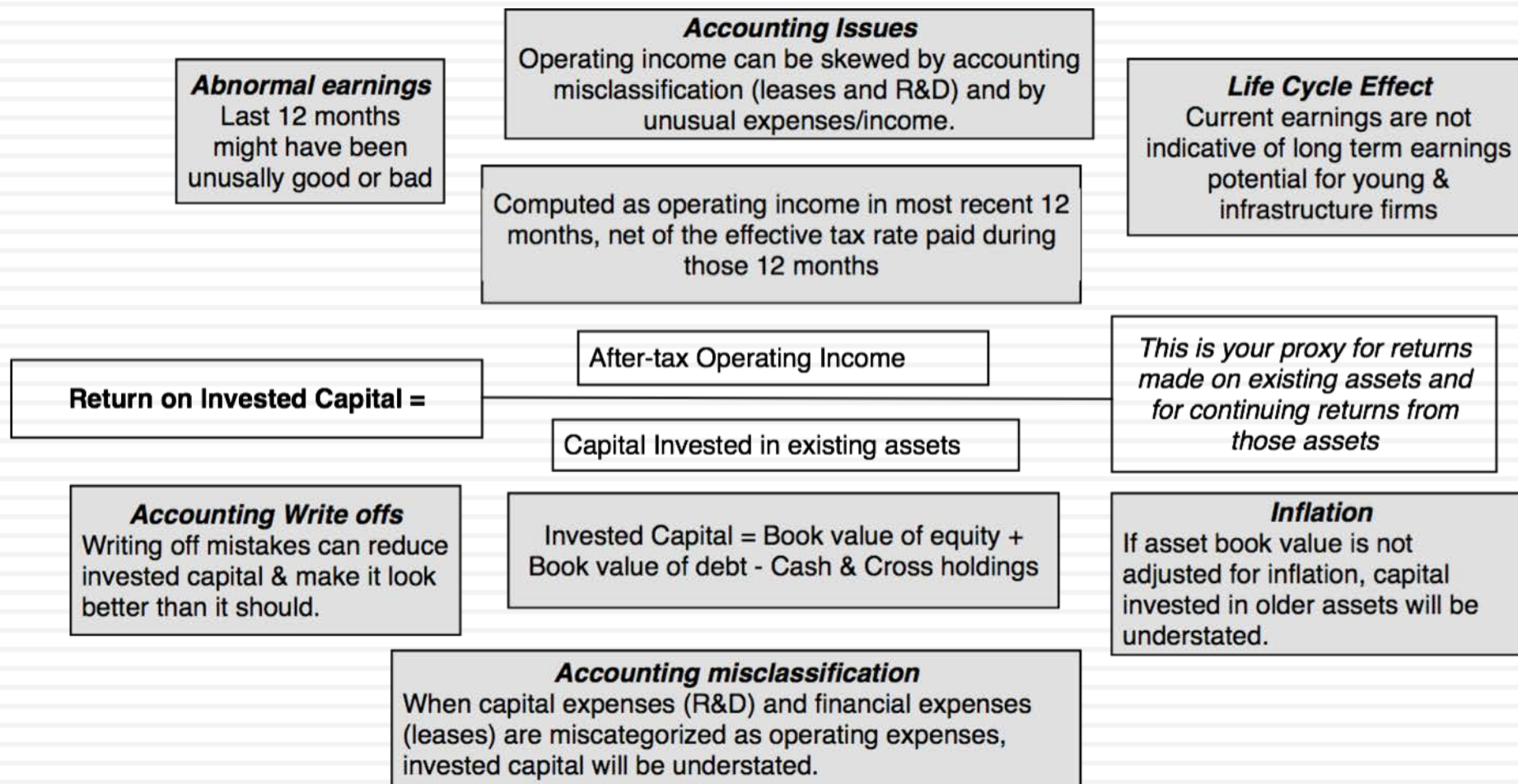

Operating income, Reinvestment & Return on Capital – Vinamilk

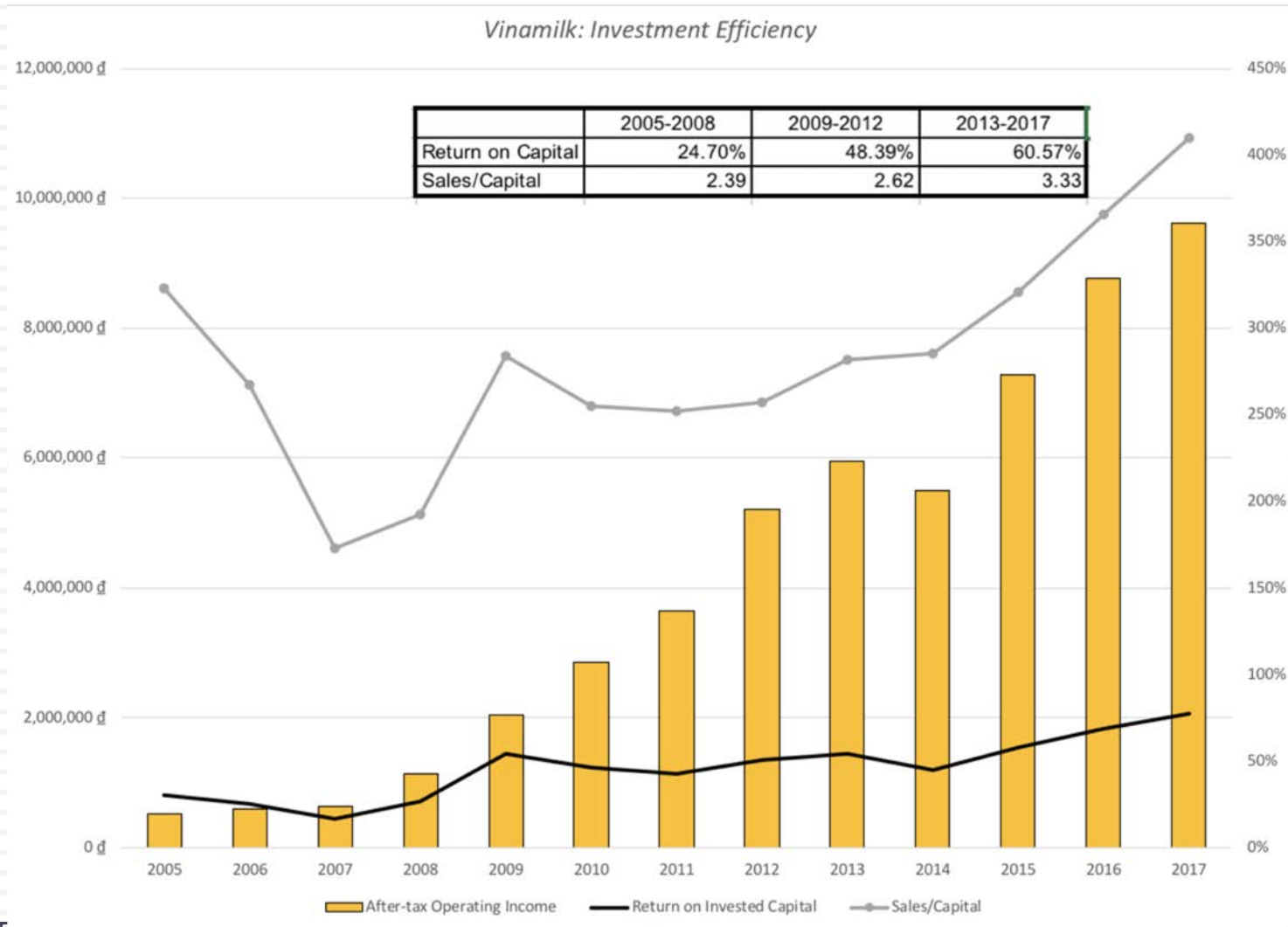

Earn at least your cost of capital! But companies seem to have trouble in practice

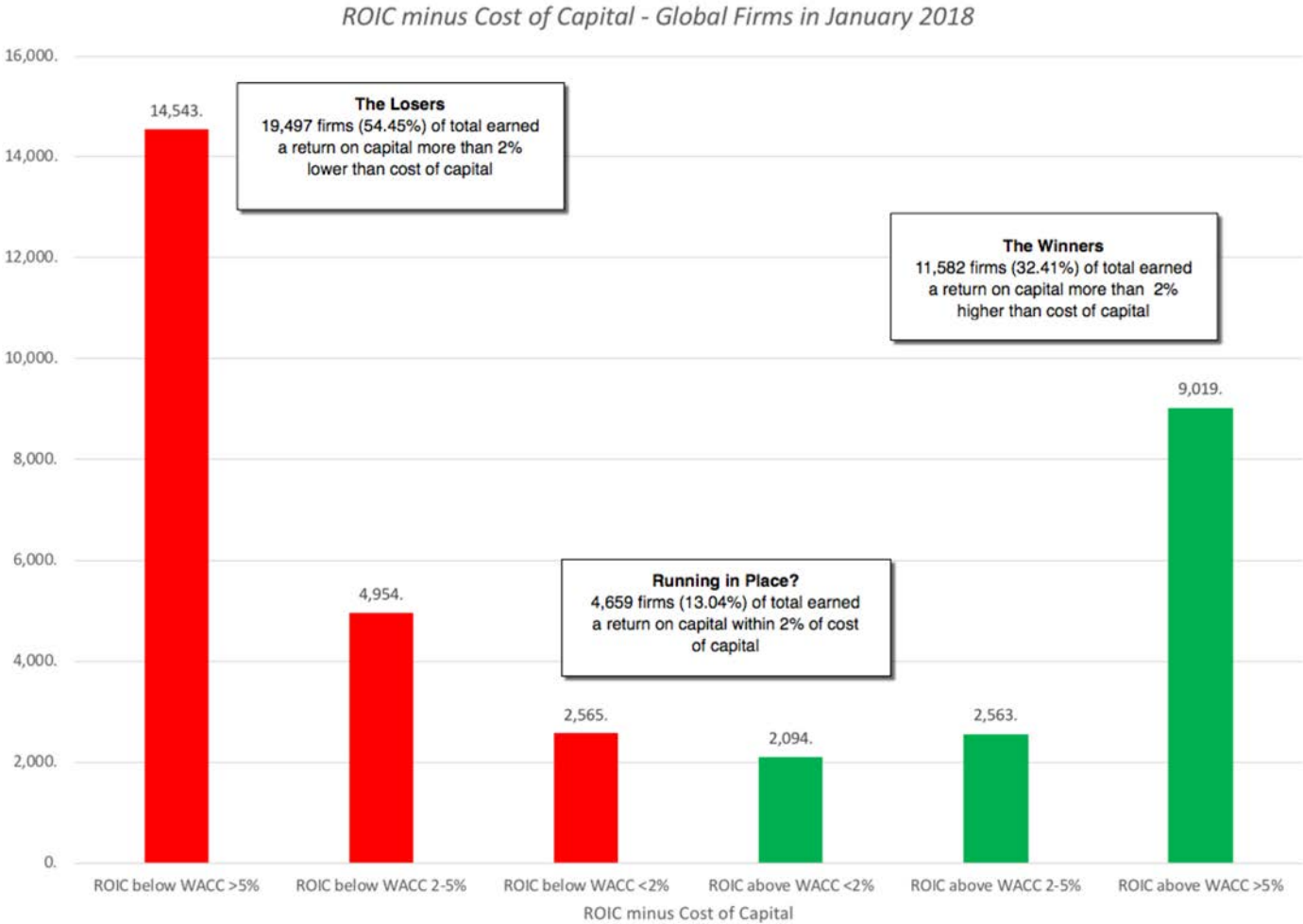

A Regional Breakdown

Sub Group	Number of firms	Cost of Capital	ROIC	ROIC - Cost of Capital	% of firms with ROIC>WACC
Africa and Middle East	1,742	9.38%	7.08%	-2.29%	36.02%
Australia & NZ	1,527	7.67%	4.98%	-2.69%	28.35%
Canada	2,601	7.89%	3.14%	-4.76%	15.88%
China	4,793	8.05%	5.74%	-2.31%	38.84%
EU & Environs	4,812	8.07%	8.88%	0.81%	42.92%
Eastern Europe & Russia	491	9.90%	7.70%	-2.19%	33.98%
India	2,966	9.55%	13.56%	4.01%	39.84%
Japan	3,487	7.83%	7.37%	-0.46%	51.73%
Latin America	748	9.28%	7.90%	-1.38%	42.92%
Small Asia	7,500	9.06%	7.55%	-1.50%	35.18%
UK	1,193	8.04%	8.06%	0.02%	44.42%
United States	6,125	7.54%	10.23%	2.69%	42.40%

A More General Way to Estimate Growth: Top Down Growth

- All of the fundamental growth equations assume that the firm has a return on equity or return on capital it can sustain in the long term.
- When operating income is negative or margins are expected to change over time, we use a three step process to estimate growth:
 - ▣ Estimate growth rates in revenues over time
 - Determine the total market (given your business model) and estimate the market share that you think your company will earn.
 - Decrease the growth rate as the firm becomes larger
 - Keep track of absolute revenues to make sure that the growth is feasible
 - ▣ Estimate expected operating margins each year
 - Set a target margin that the firm will move towards
 - Adjust the current margin towards the target margin
 - ▣ Estimate the capital that needs to be invested to generate revenue growth and expected margins
 - Estimate a sales to capital ratio that you will use to generate reinvestment needs each year.

IX. All good things come to an end..And the terminal value is not an ATM...

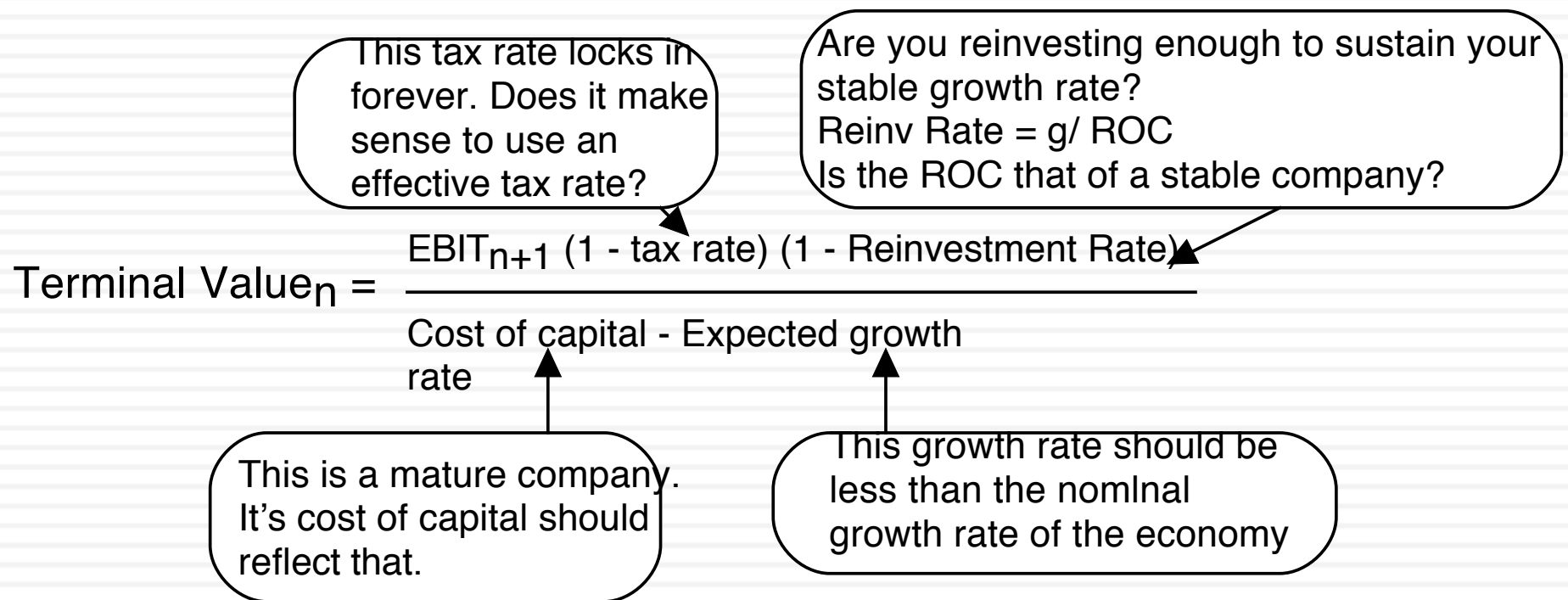

Terminal Value and Growth

Stable Growth Rate	Amgen	Tata Motors	Vinamilk
0%	\$150,652	₹ 435,686	280,714 d
1%	\$154,479	₹ 435,686	280,714 d
2%	\$160,194	₹ 435,686	280,714 d
3%	\$167,784	₹ 435,686	280,714 d
4%	\$179,099	₹ 435,686	
5%		₹ 435,686	
Risk free Rate	4.78%	5.00%	3.05%
Cost of capital	8.08%	10.39%	8.00%
Return on capital	10.00%	10.39%	8.00%



Aswath Damodaran

THE LOOSE ENDS IN VALUATION...

Aswath Damodaran

Getting from DCF to value per share: The Loose Ends

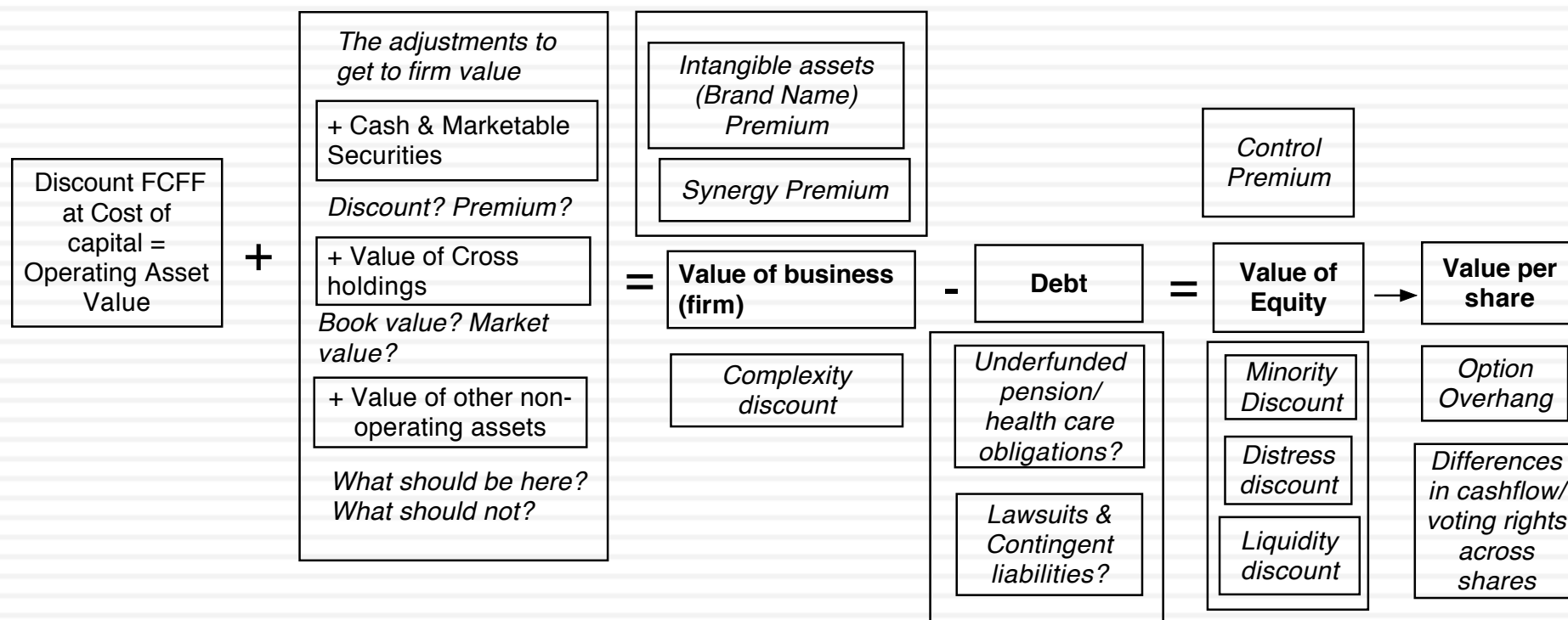

1. The Value of Cash

An Exercise in Cash Valuation

	<i>Company A</i>	<i>Company B</i>	<i>Company C</i>
Enterprise Value	\$ 1 billion	\$ 1 billion	\$ 1 billion
Cash	\$ 100 mil	\$ 100 mil	\$ 100 mil
Return on Capital	10%	5%	22%
Cost of Capital	10%	10%	12%
Trades in	US	US	Argentina

- In which of these companies is cash most likely to trade at face value, at a discount and at a premium?

Cash: Discount or Premium?

*Market Value of \$ 1 in cash:
Estimates obtained by regressing Enterprise Value against Cash Balances*

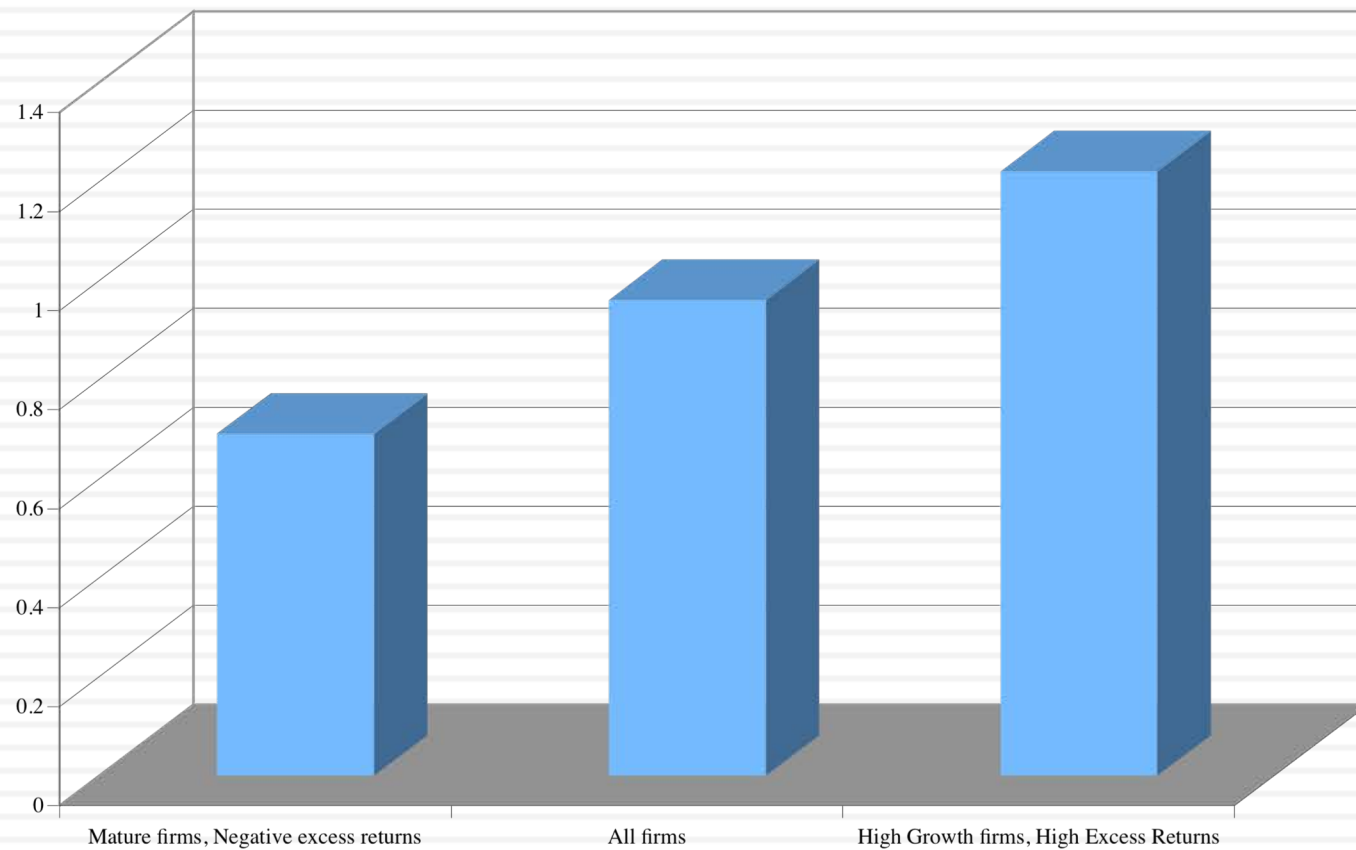

2. Dealing with Holdings in Other firms

- Holdings in other firms can be categorized into
 - Minority passive holdings, in which case only the dividend from the holdings is shown in the balance sheet
 - Minority active holdings, in which case the share of equity income is shown in the income statements
 - Majority active holdings, in which case the financial statements are consolidated.
- We tend to be sloppy in practice in dealing with cross holdings. After valuing the operating assets of a firm, using consolidated statements, it is common to add on the balance sheet value of minority holdings (which are in book value terms) and subtract out the minority interests (again in book value terms), representing the portion of the consolidated company that does not belong to the parent company.

How to value holdings in other firms.. In a perfect world..

- In a perfect world, we would strip the parent company from its subsidiaries and value each one separately. The value of the combined firm will be
 - ▣ Value of parent company + Proportion of value of each subsidiary
- To do this right, you will need to be provided detailed information on each subsidiary to estimate cash flows and discount rates.

Two compromise solutions...

- The market value solution: When the subsidiaries are publicly traded, you could use their traded market capitalizations to estimate the values of the cross holdings. You do risk carrying into your valuation any mistakes that the market may be making in valuation.
- The relative value solution: When there are too many cross holdings to value separately or when there is insufficient information provided on cross holdings, you can convert the book values of holdings that you have on the balance sheet (for both minority holdings and minority interests in majority holdings) by using the average price to book value ratio of the sector in which the subsidiaries operate.

Tata Motor's Cross Holdings

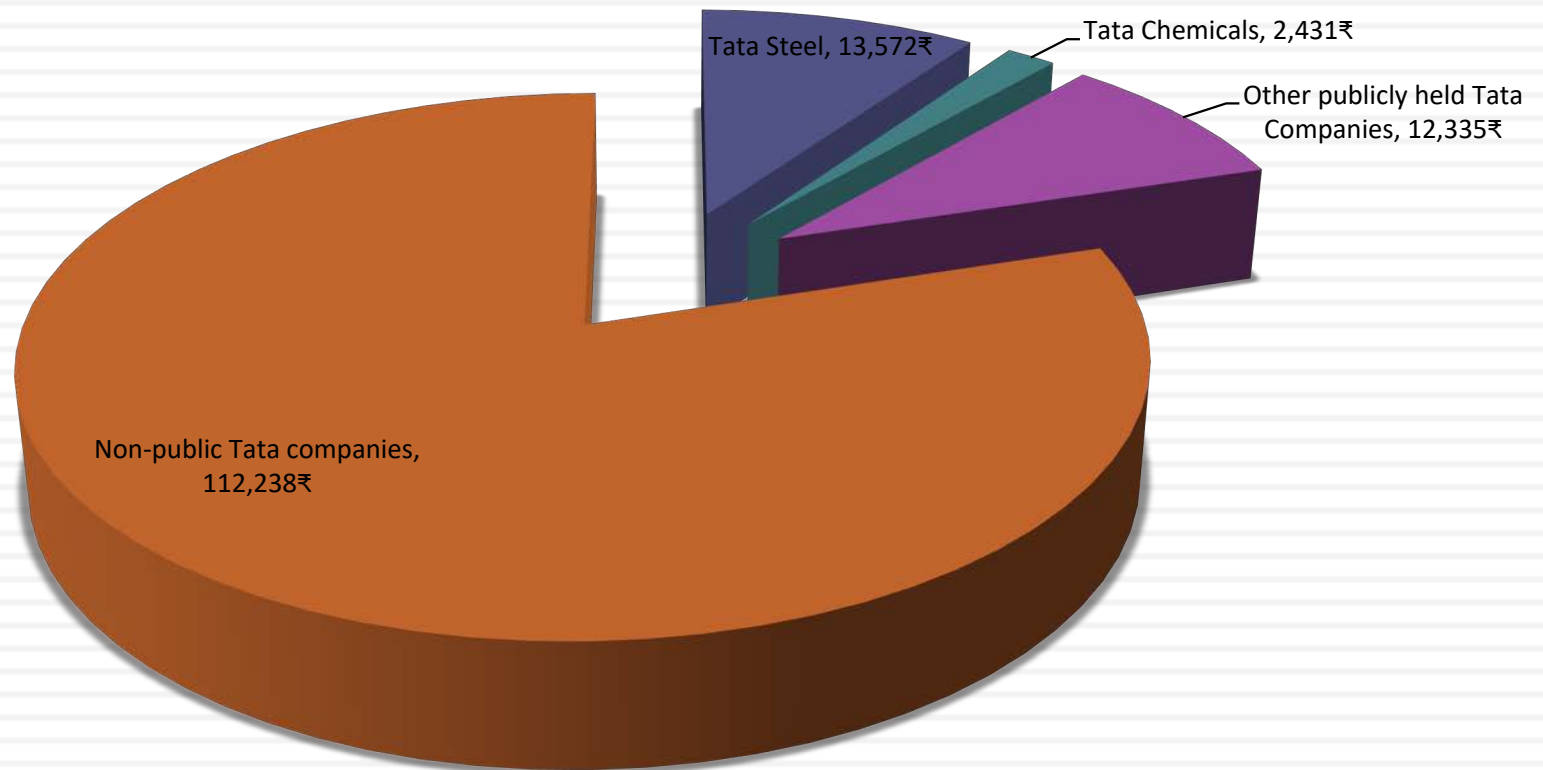

3. Other Assets that have not been counted yet..

- Unutilized assets: If you have assets or property that are not being utilized (vacant land, for example), you have not valued it yet. You can assess a market value for these assets and add them on to the value of the firm.
- Overfunded pension plans: If you have a defined benefit plan and your assets exceed your expected liabilities, you could consider the over funding with two caveats:
 - Collective bargaining agreements may prevent you from laying claim to these excess assets.
 - There are tax consequences. Often, withdrawals from pension plans get taxed at much higher rates.
- **Do not double count an asset.** If you count the income from an asset in your cash flows, you cannot count the market value of the asset in your value.

An Uncounted Asset?

65

Price tag: \$200 million



The longtime home of Playboy magazine founder Hugh Hefner is to be sold to Daren Metropoulos, a principal at private-equity firm Metropoulos & Co. PHOTO: GETTY IMAGES

The Real Estate Play!

- Assume that you value a Vietnamese hotel company, with its hotels in Ho Chi Minh City, as a hotel firm and arrive at a value of 1 billion VND. Now assume that the land that the factory sits on is worth 1.5 billion VND. What value would you attach to the firm?
 - a. 1 billion VND
 - b. 1.5 billion VND
 - c. 2.5 billion VND

4. A Discount for Complexity: An Experiment

	Company A	Company B
Operating Income	\$ 1 billion	\$ 1 billion
Tax rate	40%	40%
ROIC	10%	10%
Expected Growth	5%	5%
Cost of capital	8%	8%
Business Mix	Single	Multiple Businesses
Holdings	Simple	Complex
Accounting	Transparent	Opaque

□ Which firm would you value more highly?

Measuring Complexity: Volume of Data in Financial Statements

<i>Company</i>	<i>Number of pages in last 10Q</i>	<i>Number of pages in last 10K</i>
General Electric	65	410
Microsoft	63	218
Wal-mart	38	244
Exxon Mobil	86	332
Pfizer	171	460
Citigroup	252	1026
Intel	69	215
AIG	164	720
Johnson & Johnson	63	218
IBM	85	353

Measuring Complexity: A Complexity Score

Item	Factors	Follow-up Question	Answer	Weighting factor	Gerdau Score	GE Score
Operating Income	1. Multiple Businesses	Number of businesses (with more than 10% of revenues) =	1	2.00	2	30
	2. One-time income and expenses	Percent of operating income =	10%	10.00	1	0.8
	3. Income from unspecified sources	Percent of operating income =	0%	10.00	0	1.2
	4. Items in income statement that are volatile	Percent of operating income =	15%	5.00	0.75	1
Tax Rate	1. Income from multiple locales	Percent of revenues from non-domestic locales =	70%	3.00	2.1	1.8
	2. Different tax and reporting books	Yes or No	No	Yes=3	0	3
	3. Headquarters in tax havens	Yes or No	No	Yes=3	0	0
	4. Volatile effective tax rate	Yes or No	Yes	Yes=2	2	0
Capital Expenditures	1. Volatile capital expenditures	Yes or No	Yes	Yes=2	2	2
	2. Frequent and large acquisitions	Yes or No	Yes	Yes=4	4	4
	3. Stock payment for acquisitions and investments	Yes or No	No	Yes=4	0	4
Working capital	1. Unspecified current assets and current liabilities	Yes or No	No	Yes=3	0	0
	2. Volatile working capital items	Yes or No	Yes	Yes=2	2	2
Expected Growth rate	1. Off-balance sheet assets and liabilities (operating leases and R&D)	Yes or No	No	Yes=3	0	3
	2. Substantial stock buybacks	Yes or No	No	Yes=3	0	3
	3. Changing return on capital over time	Is your return on capital volatile?	Yes	Yes=5	5	5
	4. Unsustainably high return	Is your firm's ROC much higher than industry average?	No	Yes=5	0	0
Cost of capital	1. Multiple businesses	Number of businesses (more than 10% of revenues) =	1	1.00	1	20
	2. Operations in emerging markets	Percent of revenues=	50%	5.00	2.5	2.5
	3. Is the debt market traded?	Yes or No	No	No=2	2	0
	4. Does the company have a rating?	Yes or No	Yes	No=2	0	0
	5. Does the company have off-balance sheet debt?	Yes or No	No	Yes=5	0	5
No-operating assets	Minority holdings as percent of book assets	Minority holdings as percent of book assets	0%	20.00	0	0.8
Firm to Equity value	Consolidation of subsidiaries	Minority interest as percent of book value of equity	63%	20.00	12.6	1.2
Per share value	Shares with different voting rights	Does the firm have shares with different voting rights?	Yes	Yes = 10	10	0
	Equity options outstanding	Options outstanding as percent of shares	0%	10.00	0	0.69
Complexity Score =					48.95	90.55

Dealing with Complexity

- In Discounted Cashflow Valuation
 - The Aggressive Analyst: Trust the firm to tell the truth and value the firm based upon the firm's statements about their value.
 - The Conservative Analyst: Don't value what you cannot see.
 - The Compromise: Adjust the value for complexity
 - Adjust cash flows for complexity
 - Adjust the discount rate for complexity
 - Adjust the expected growth rate/ length of growth period
 - Value the firm and then discount value for complexity
- In relative valuation
 - In a relative valuation, you may be able to assess the price that the market is charging for complexity:
 - With the hundred largest market cap firms, for instance:
$$\text{PBV} = 0.65 + 15.31 \text{ ROE} - 0.55 \text{ Beta} + 3.04 \text{ Expected growth rate} - 0.003 \text{ \# Pages in 10K}$$

5. The Value of Synergy

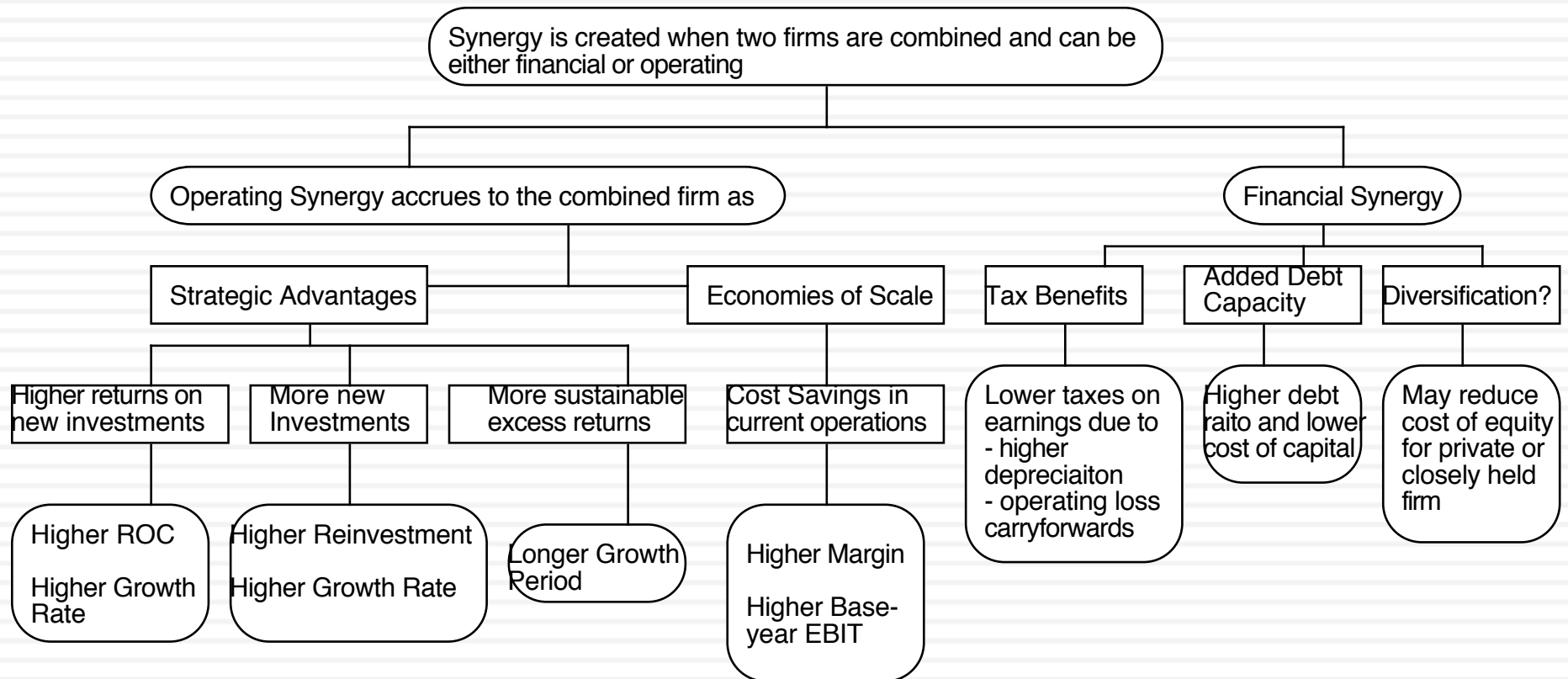

Valuing Synergy

- (1) the firms involved in the merger are valued independently, by discounting expected cash flows to each firm at the weighted average cost of capital for that firm.
- (2) the value of the combined firm, with no synergy, is obtained by adding the values obtained for each firm in the first step.
- (3) The effects of synergy are built into expected growth rates and cashflows, and the combined firm is re-valued with synergy.

Value of Synergy = Value of the combined firm, with synergy - Value of the combined firm, without synergy

Inbev + SAB Miller: Where's the synergy?

	<i>Inbev</i>	<i>SABMiller</i>	<i>Combined firm (status quo)</i>	<i>Combined firm (synergy)</i>
Levered Beta	0.85	0.8289	0.84641	0.84641
Pre-tax cost of debt	3.0000%	3.2000%	3.00%	3.00%
Effective tax rate	18.00%	26.36%	19.92%	19.92%
Debt to Equity Ratio	30.51%	23.18%	29.71%	29.71%
Revenues	\$45,762.00	\$22,130.00	\$67,892.00	\$67,892.00
Operating Margin	32.28%	19.97%	28.27%	30.00%
Operating Income (EBIT)	\$14,771.97	\$4,419.36	\$19,191.33	\$20.368
After-tax return on capital	12.10%	12.64%	11.68%	12.00%
Reinvestment Rate =	50.99%	33.29%	43.58%	50.00%
Expected Growth Rate	6.17%	4.21%	5.09%	6.00%

The value of synergy

	<i>Inbev</i>	<i>SABMiller</i>	<i>Combined firm (status quo)</i>	<i>Combined firm (synergy)</i>
Cost of Equity =	8.93%	9.37%	9.12%	9.12%
After-tax cost of debt =	2.10%	2.24%	2.10%	2.10%
Cost of capital =	7.33%	8.03%	7.51%	7.51%
After-tax return on capital =	12.10%	12.64%	11.68%	12.00%
Reinvestment Rate =	50.99%	33.29%	43.58%	50.00%
Expected growth rate=	6.17%	4.21%	5.09%	6.00%
<i>Value of firm</i>				
PV of FCFF in high growth =	\$28,733	\$9,806	\$38,539	\$39,151
Terminal value =	\$260,982	\$58,736	\$319,717	\$340,175
Value of operating assets =	\$211,953	\$50,065	\$262,018	\$276,610

Value of synergy = 276,610 – 262,018 = 14,592 million 74

6. Brand name, great management, superb product ...Are we short changing intangibles?

- There is often a temptation to add on premiums for intangibles. Here are a few examples.
 - ▣ Brand name
 - ▣ Great management
 - ▣ Loyal workforce
 - ▣ Technological prowess
- There are two potential dangers:
 - ▣ For some assets, the value may already be in your value and adding a premium will be double counting.
 - ▣ For other assets, the value may be ignored but incorporating it will not be easy.

Valuing Brand Name

	Coca Cola	With Cott Margins
Current Revenues =	\$21,962.00	\$21,962.00
Length of high-growth period	10	10
Reinvestment Rate =	50%	50%
Operating Margin (after-tax)	15.57%	5.28%
Sales/Capital (Turnover ratio)	1.34	1.34
Return on capital (after-tax)	20.84%	7.06%
Growth rate during period (g) =	10.42%	3.53%
Cost of Capital during period =	7.65%	7.65%
Stable Growth Period		
Growth rate in steady state =	4.00%	4.00%
Return on capital =	7.65%	7.65%
Reinvestment Rate =	52.28%	52.28%
Cost of Capital =	7.65%	7.65%
Value of Firm =	\$79,611.25	\$15,371.24

Valuing a Franchise: Star Wars

Star Wars Franchise Valuation: December 2015

	Add-on \$ per Box Office \$
Streaming/Video	\$1.20
Toys & Merchandise	\$2.00
Books/eBooks	\$0.20
Gaming	\$0.50
Other	\$0.50

Main Movies
World Box office of \$1.5 billion, adjusted for 2% inflation.

Spin Off Movies
World Box office is 50% of main movies.

	Main Star Wars Movies			Star Wars Spin offs		
	Star Wars VII	Star Wars VIII	Star Wars IX	Rogue One	Hans Solo?	Boba Fett?
Years from now	0.0	2.0	4.0	1.0	3.0	5.0
Movies - Revenues	\$2,000	\$2,081	\$2,165	\$1,020	\$1,061	\$1,104
Streaming/Video - Revenues	\$2,400	\$2,497	\$2,598	\$1,224	\$1,273	\$1,325
Toys & Merchandise - Revenues	\$4,000	\$4,162	\$4,330	\$2,040	\$2,122	\$2,208
Books/eBooks - Revenues	\$400	\$416	\$433	\$204	\$212	\$221
Gaming - Revenues	\$1,000	\$1,040	\$1,082	\$510	\$531	\$552
Other - Revenues	\$1,000	\$1,040	\$1,082	\$510	\$531	\$552
Total - Revenues	\$10,800	\$11,236	\$11,690	\$5,508	\$5,731	\$5,962
After-tax Operating Income (movies)	\$ 282	\$ 293	\$ 305	\$ 144	\$ 150	\$ 156
After-tax Operating Income (non-movies)	\$ 924	\$ 961	\$ 1,000	\$ 471	\$ 490	\$ 510
Present Value	\$ 1,206	\$ 1,083	\$ 973	\$ 572	\$ 514	\$ 461
Value of new Star Wars movies =	\$4,809					
Value of continuing income =	\$5,163					
Value of Star Wars =	\$9,972					

Add on \$ per box office \$

Operating Margin
20.14% for movies
15% for non-movies
30% tax rate

Discounted back @ 7.61% cost of capital of entertainment companies

Assumes that revenues from add ons continue after 2020, growing at 2% a year, with 15% operating margin

7. Be circumspect about defining debt for cost of capital purposes...

- General Rule: Debt generally has the following characteristics:
 - ▣ Commitment to make fixed payments in the future
 - ▣ The fixed payments are tax deductible
 - ▣ Failure to make the payments can lead to either default or loss of control of the firm to the party to whom payments are due.
- Defined as such, debt should include
 - ▣ All interest bearing liabilities, short term as well as long term
 - ▣ All leases, operating as well as capital
- Debt should not include
 - ▣ Accounts payable or supplier credit

But should consider other potential liabilities when getting to equity value...

- If you have under funded pension fund or health care plans, you should consider the under funding at this stage in getting to the value of equity.
 - If you do so, you should not double count by also including a cash flow line item reflecting cash you would need to set aside to meet the unfunded obligation.
 - You should not be counting these items as debt in your cost of capital calculations....
- If you have contingent liabilities - for example, a potential liability from a lawsuit that has not been decided - you should consider the expected value of these contingent liabilities
 - Value of contingent liability = Probability that the liability will occur *
Expected value of liability

8. The Value of Control

- The value of the control premium that will be paid to acquire a block of equity will depend upon two factors -
 - Probability that control of firm will change: This refers to the probability that incumbent management will be replaced. this can be either through acquisition or through existing stockholders exercising their muscle.
 - Value of Gaining Control of the Company: The value of gaining control of a company arises from two sources - the increase in value that can be wrought by changes in the way the company is managed and run, and the side benefits and perquisites of being in control
 - Value of Gaining Control = Present Value (Value of Company with change in control - Value of company without change in control) + Side Benefits of Control

Increase Cash Flows

Reduce the cost of capital

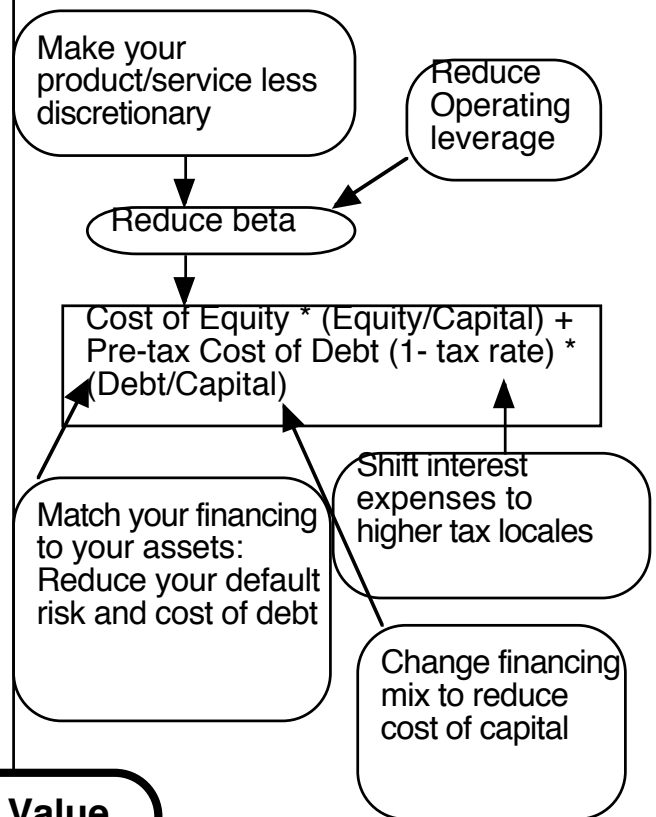
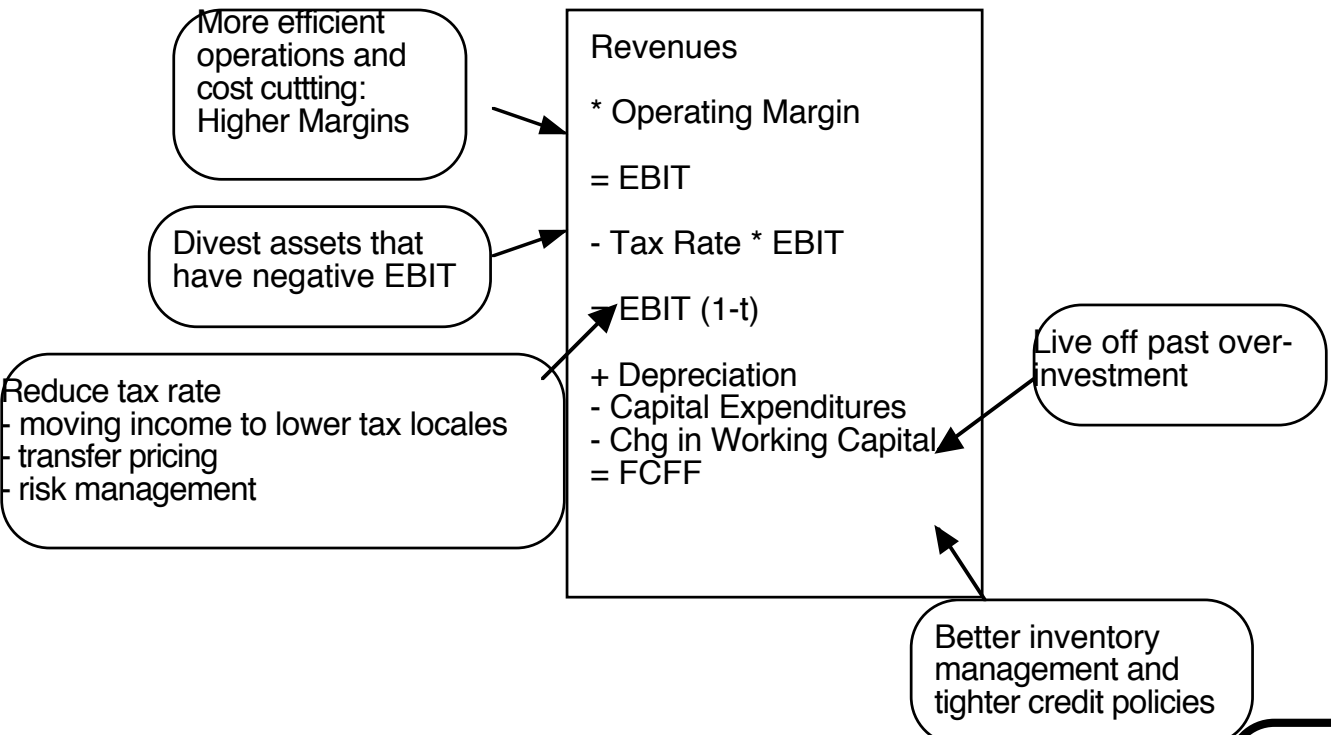

Firm Value

Increase Expected Growth

Increase length of growth period

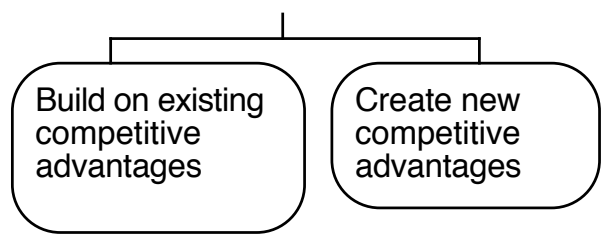
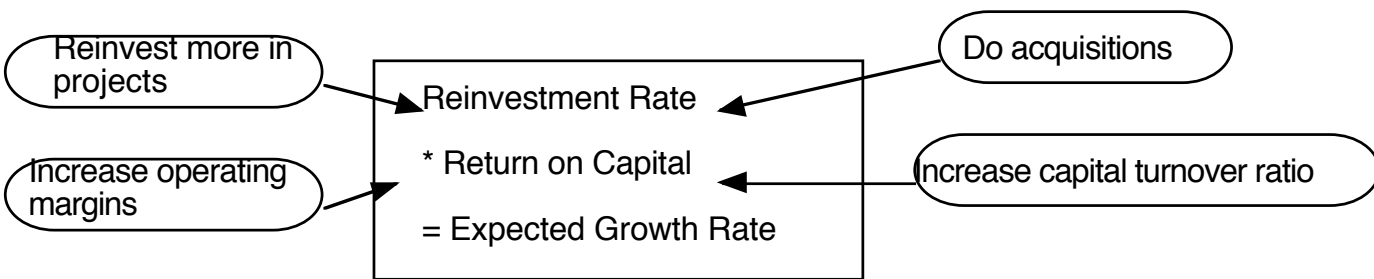

Adris Grupa (Status Quo): 4/2010

Current Cashflow to Firm
 EBIT(1-t) : 436 HRK
 - Nt CpX 3 HRK
 - Chg WC -118 HRK
 = FCFF 551 HRK
 Reinv Rate = $(3-118)/436 = -26.35\%$;
 Tax rate = 17.35%
 Return on capital = 8.72%

Average from 2004-09
 70.83%

Reinvestment Rate
 70.83%

Expected Growth from new inv.
 $.7083 \times .0969 = 0.0686$
 or 6.86%

Average from 2004-09
 9.69%

Return on Capital
 9.69%

Stable Growth
 $g = 4\%$; Beta = 0.80
 Country Premium = 2%
 Cost of capital = 9.92%
 Tax rate = 20.00%
 ROC = 9.92%;
 Reinvestment Rate = $g/ROC = 4/9.92 = 40.32\%$

Terminal Value₅ = $365 / (.0992 - .04) = 6170$ HRK

Op. Assets 4312
 + Cash: 1787
 - Debt 141
 - Minority int 465
 = Equity 5,484
 / (Common + Preferred shares)
 Value non-voting share 335 HRK/share

Year	1	2	3	4	5	
EBIT (1-t)	HRK 466	HRK 498	HRK 532	HRK 569	HRK 608	612 246 365
- Reinvestment	HRK 330	HRK 353	HRK 377	HRK 403	HRK 431	
FCFF	HRK 136	HRK 145	HRK 155	HRK 166	HRK 177	

Discount at \$ Cost of Capital (WACC) = 10.7% (.974) + 5.40% (0.026) = 10.55%

Cost of Equity
 10.70%

Cost of Debt
 $(4.25\% + 0.5\% + 2\%)(1 - .20) = 5.40\%$

Weights
 E = 97.4% D = 2.6%

On May 1, 2010
 AG Pfd price = 279 HRK
 AG Common = 345 HRK

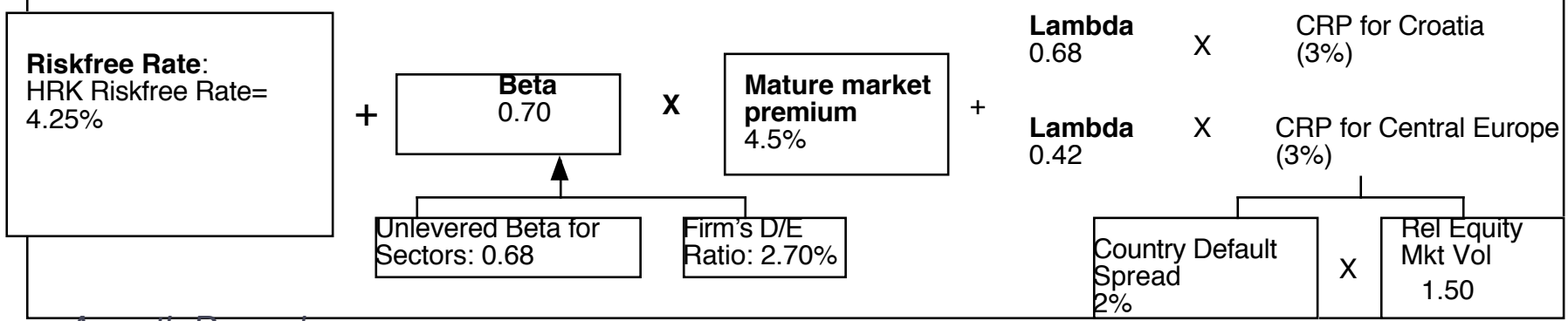

Adris Grupa: 4/2010 (Restructured)

Current Cashflow to Firm
 EBIT(1-t) : 436 HRK
 - Nt CpX 3 HRK
 - Chg WC -118 HRK
 = FCF 551 HRK
 Reinv Rate= (3-118)/436=-26.35%;
 Tax rate = 17.35%
 Return on capital = 8.72%

Increased ROIC to cost of capital

Reinvestment Rate
70.83%

Expected Growth from new inv.
 $.7083 \times .01054 = 0.00746$
 or 6.86%

Return on Capital
10.54%

Stable Growth
 g = 4%; Beta = 0.80
 Country Premium = 2%
 Cost of capital = 9.65%
 Tax rate = 20.00%
 ROC = 9.65%;
 Reinvestment Rate = $g/ROC = 4/9.65\% = 41.47\%$

Terminal Value₅ = $367 / (.0965 - .04) = 6508$ HRK

Op. Assets 4545
 + Cash: 1787
 - Debt 141
 - Minority int 465
 = Equity 5,735
 Value/non-voting 334
 Value/voting 362

Year	1	2	3	4	5	
EBIT (1-t)	HRK 469	HRK 503	HRK 541	HRK 581	HRK 623	
- Reinvestment	HRK 332	HRK 356	HRK 383	HRK 411	HRK 442	
FCFF	HRK 137	HRK 147	HRK 158	HRK 169	HRK 182	
						628 246 367

Discount at \$ Cost of Capital (WACC) = $11.12\% (.90) + 8.20\% (0.10) = 10.54\%$

Changed mix of debt and equity to optimal

Cost of Equity
11.12%

Cost of Debt
 $(4.25\% + 4\% + 2\%) (1 - .20) = 8.20\%$

Weights
E = 90 % D = 10 %

On May 1, 2010
 AG Pfd price = 279 HRK
 AG Common = 345 HRK

Riskfree Rate:
HRK Riskfree Rate = 4.25%

+ Beta 0.75 X Mature market premium 4.5%

Unlevered Beta for Sectors: 0.68

Firm's D/E Ratio: 11.1%

Lambda 0.68 X CRP for Croatia (3%)
 Lambda 0.42 X CRP for Central Europe (3%)

Country Default Spread 2%

Rel Equity Mkt Vol 1.50

Value of Control and the Value of Voting Rights

- Adris Grupa has two classes of shares outstanding: 9.616 million voting shares and 6.748 million non-voting shares.
- To value a non-voting share, we assume that all non-voting shares essentially have to settle for status quo value. All shareholders, common and preferred, get an equal share of the status quo value.

Status Quo Value of Equity = 5,484 million HKR

Value for a non-voting share = $5484 / (9.616 + 6.748) = 334$ HKR/share

- To value a voting share, we first value control in Adris Grup as the difference between the optimal and the status quo value:

Value of control at Adris Grupa = $5,735 - 5484 = 249$ million HKR

- If you assume a 100% probability of change occurring, the value per voting share can be written as:

Value per voting share = 334 HKR + $249 / 9.616 = 362$ HKR

- If the probability of control changing is only 40%, the expected value of control and value per voting share can be written as follows:

- Expected value of control = $249 (.4) = 99.6$ million HKR

- Value per voting share = 334 HKR + $99.6 / 9.616 = 344$ HKR

Aswath Damodaran



THE DARK SIDE OF VALUATION: VALUING DIFFICULT-TO-VALUE COMPANIES

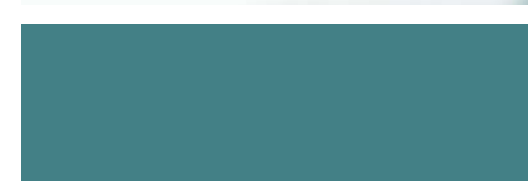

The fundamental determinants of value...

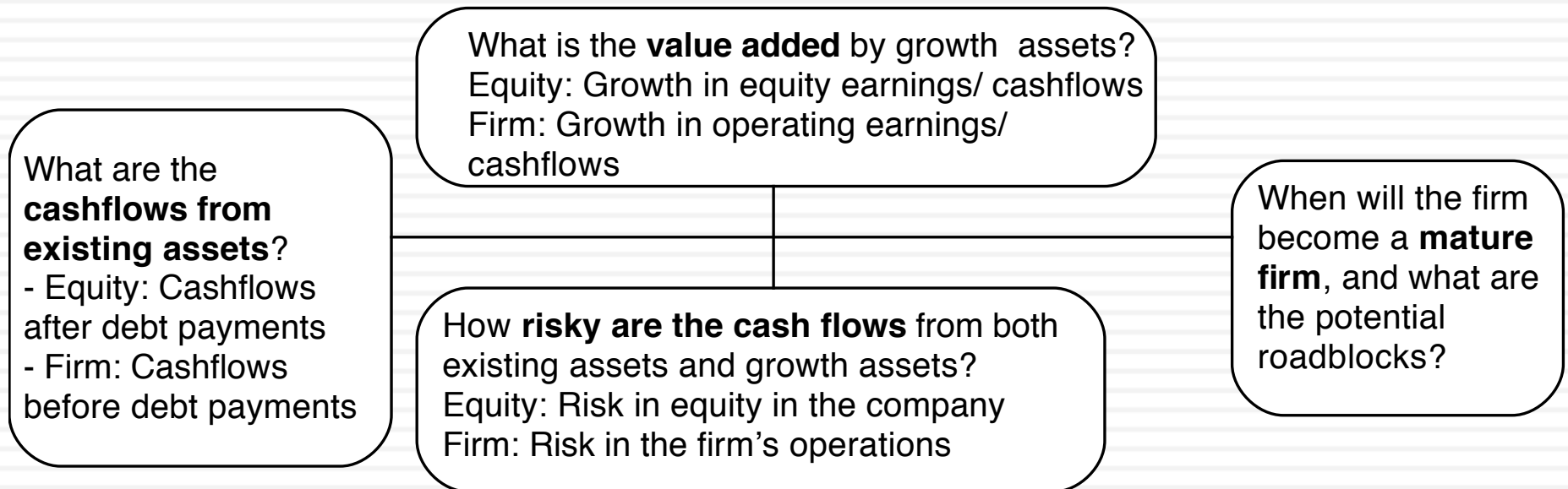

The Dark Side of Valuation...

- Valuing stable, money making companies with consistent and clear accounting statements, a long and stable history and lots of comparable firms is easy to do.
- The true test of your valuation skills is when you have to value “difficult” companies. In particular, the challenges are greatest when valuing:
 - Young companies, early in the life cycle, in young businesses
 - Companies that don’t fit the accounting mold
 - Companies that face substantial truncation risk (default or nationalization risk)

Difficult to value companies...

- Across the life cycle:
 - ▣ Young, growth firms: Limited history, small revenues in conjunction with big operating losses and a propensity for failure make these companies tough to value.
 - ▣ Mature companies in transition: When mature companies change or are forced to change, history may have to be abandoned and parameters have to be reestimated.
 - ▣ Declining and Distressed firms: A long but irrelevant history, declining markets, high debt loads and the likelihood of distress make them troublesome.
- Across sectors
 - ▣ Financial service firms: Opacity of financial statements and difficulties in estimating basic inputs leave us trusting managers to tell us what's going on.
 - ▣ Commodity and cyclical firms: Dependence of the underlying commodity prices or overall economic growth make these valuations susceptible to macro factors.
 - ▣ Firms with intangible assets: Accounting principles are left to the wayside on these firms.
- Across the ownership cycle
 - ▣ Privately owned businesses: Exposure to firm specific risk and illiquidity bedevil valuations.
 - ▣ Venture Capital (VC) and private equity: Different equity investors, with different perceptions of risk.
 - ▣ Closely held public firms: Part private and part public, sharing the troubles of both.

I. The challenge with young companies...

Figure 5.2: Estimation Issues - Young and Start-up Companies

Making judgments on revenues/ profits difficult because you cannot draw on history. If you have no product/ service, it is difficult to gauge market potential or profitability. The company's entire value lies in future growth but you have little to base your estimate on.

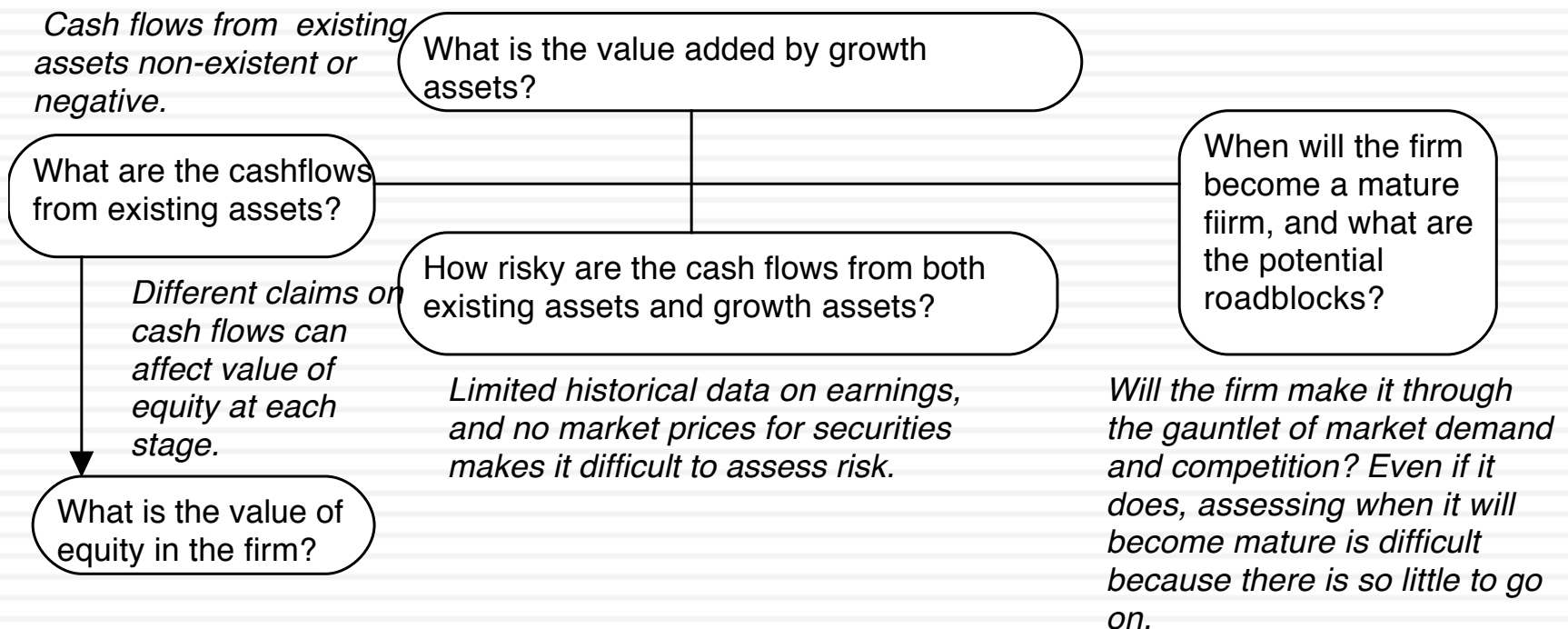

Upping the ante.. Young companies in young businesses...

- When valuing a business, we generally draw on three sources of information
 - ▣ The firm's current financial statement
 - How much did the firm sell?
 - How much did it earn?
 - ▣ The firm's financial history, usually summarized in its financial statements.
 - How fast have the firm's revenues and earnings grown over time?
 - What can we learn about cost structure and profitability from these trends?
 - Susceptibility to macro-economic factors (recessions and cyclical firms)
 - ▣ The industry and comparable firm data
 - What happens to firms as they mature? (Margins.. Revenue growth... Reinvestment needs... Risk)
- It is when valuing these companies that you find yourself tempted by the dark side, where
 - ▣ "Paradigm shifts" happen...
 - ▣ New metrics are invented ...
 - ▣ The story dominates and the numbers lag...

Amazon in January 2000

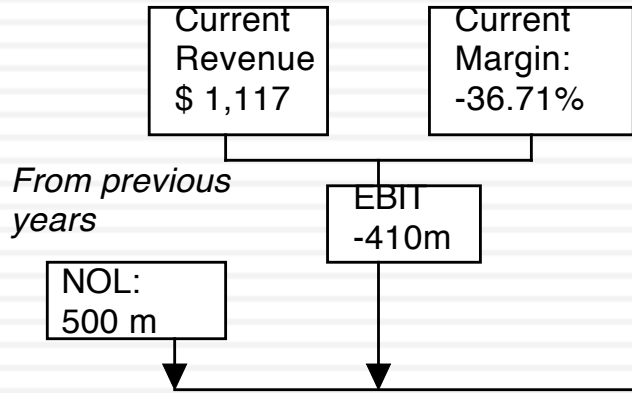

Sales to capital ratio and expected margin are retail industry average numbers

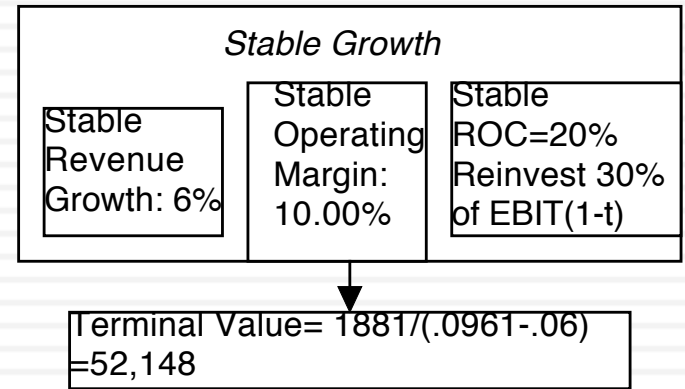
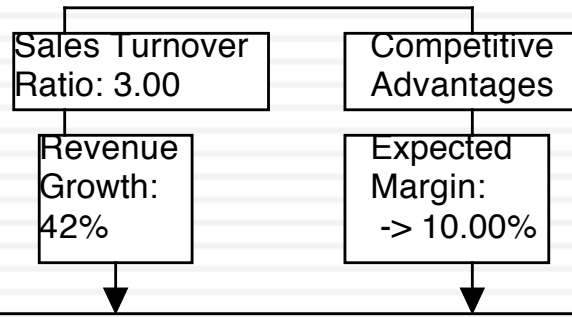

Value of Op Assets \$ 15,170

+ Cash \$ 26

= Value of Firm \$15,196

- Value of Debt \$ 349

= Value of Equity \$14,847

- Equity Options \$ 2,892

Value per share \$ 35.08

Revenue Growth	150.00%	100.00%	75.00%	50.00%	30.00%	25.20%	20.40%	15.60%	10.80%	6.00%
Revenues	\$ 2,793	\$ 5,585	\$ 9,774	\$ 14,661	\$ 19,059	\$ 23,862	\$ 28,729	\$ 33,211	\$ 36,798	\$ 39,006
Operating Margin	-13.35%	-1.68%	4.16%	7.08%	8.54%	9.27%	9.64%	9.82%	9.91%	9.95%
EBIT	-\$373	-\$94	\$407	\$1,038	\$1,628	\$2,212	\$2,768	\$3,261	\$3,646	\$3,883
EBIT(1-t)	-\$373	-\$94	\$407	\$871	\$1,058	\$1,438	\$1,799	\$2,119	\$2,370	\$2,524
- Reinvestment	\$600	\$967	\$1,420	\$1,663	\$1,543	\$1,688	\$1,721	\$1,619	\$1,363	\$961
FCFF	-\$931	-\$1,024	-\$989	-\$758	-\$408	-\$163	\$177	\$625	\$1,174	\$1,788

Term. Year	6%
	\$ 41,346
	10.00%
	\$4,135
	\$2,688
	\$155
	\$1,881

	1	2	3	4	5	6	7	8	9	10	Forever
Cost of Equity	12.90%	12.90%	12.90%	12.90%	12.90%	12.42%	11.94%	11.46%	10.98%	10.50%	
Cost of Debt	8.00%	8.00%	8.00%	8.00%	8.00%	7.80%	7.75%	7.67%	7.50%	7.00%	
After-tax cost of debt	8.00%	8.00%	8.00%	6.71%	5.20%	5.07%	5.04%	4.98%	4.88%	4.55%	
Cost of Capital	12.84%	12.84%	12.84%	12.83%	12.81%	12.13%	11.62%	11.08%	10.49%	9.61%	

All existing options valued as options, using current stock price of \$84.

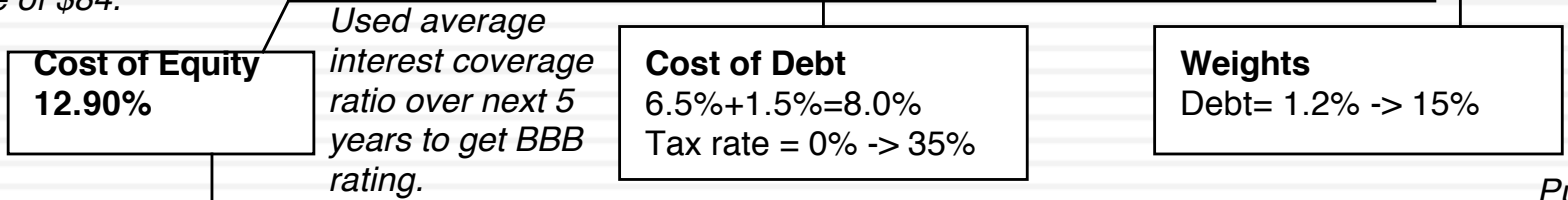

Amazon was trading at \$84 in January 2000.

Pushed debt ratio to retail industry average of 15%.

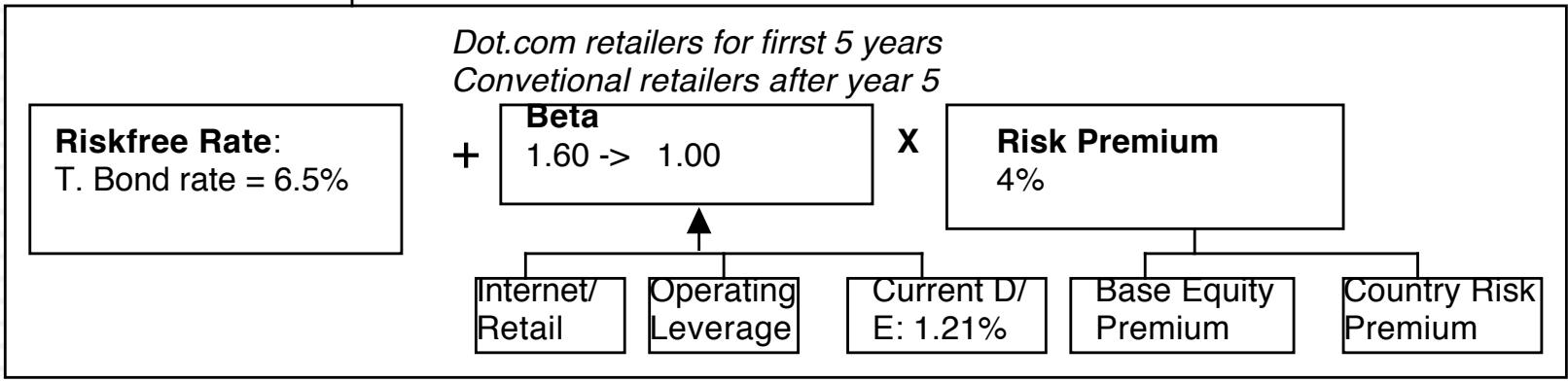

Lesson 1: Don't trust regression betas....

<HELP> for explanation, <MENU> for similar functions.

DG26 Equity BETA

HISTORICAL BETA

AMZN

US

AMAZON.COM INC

Relative Index

SPX

S&P 500 INDEX

* Identifies latest observation

Period Weekly

Range 2/27/98 To 2/18/00

Market Trade

ADJ BETA	1.82
RAW BETA	2.23
Alpha (Intercept)	2.60
R2 (Correlation)	.17
Std Dev of Error	13.20
Std Error of Beta	.50
Number of Points	103

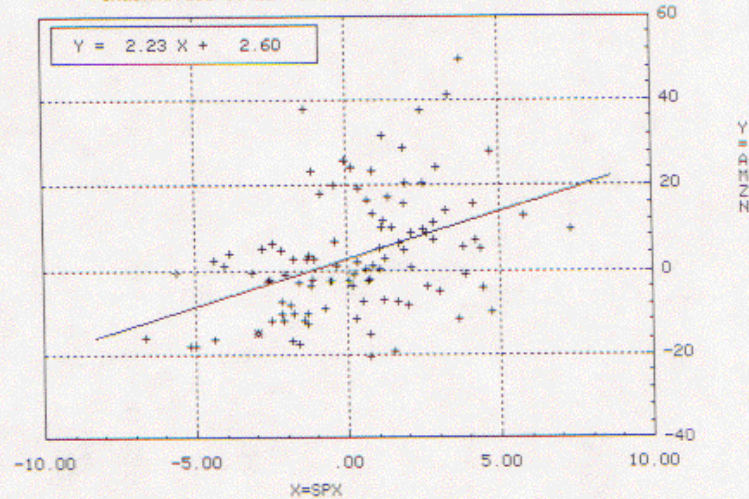

Adj beta = (0.67) * Raw Beta
+ (0.33) * 1.0

Copyright 2000 BLOOMBERG L.P. Frankfurt:69-920410 Hong Kong:2-977-6000 London:171-330-7500 New York:212-318-2000
Princeton:609-279-3000 Singapore:226-3000 Sydney:2-9777-8686 Tokyo:3-3201-8900 Sao Paulo:11-3048-4500
1257-602-0 22-Feb-00 16:21:23

Bloomberg
PROFESSIONAL

Lesson 2: Work backwards and keep it simple...

Year	Revenue Growth	Sales	Operating Margin	EBIT	EBIT (1-t)
Tr 12 mths		\$1,117	-36.71%	-\$410	-\$410
1	150.00%	\$2,793	-13.35%	-\$373	-\$373
2	100.00%	\$5,585	-1.68%	-\$94	-\$94
3	75.00%	\$9,774	4.16%	\$407	\$407
4	50.00%	\$14,661	7.08%	\$1,038	\$871
5	30.00%	\$19,059	8.54%	\$1,628	\$1,058
6	25.20%	\$23,862	9.27%	\$2,212	\$1,438
7	20.40%	\$28,729	9.64%	\$2,768	\$1,799
8	15.60%	\$33,211	9.82%	\$3,261	\$2,119
9	10.80%	\$36,798	9.91%	\$3,646	\$2,370
10	6.00%	\$39,006	9.95%	\$3,883	\$2,524
TY	6.00%	\$41,346	10.00%	\$4,135	\$2,688

Lesson 3: Scaling up is hard to do...

Typically, the revenue growth rate of a newly public company outpaces its industry average for only about five years.

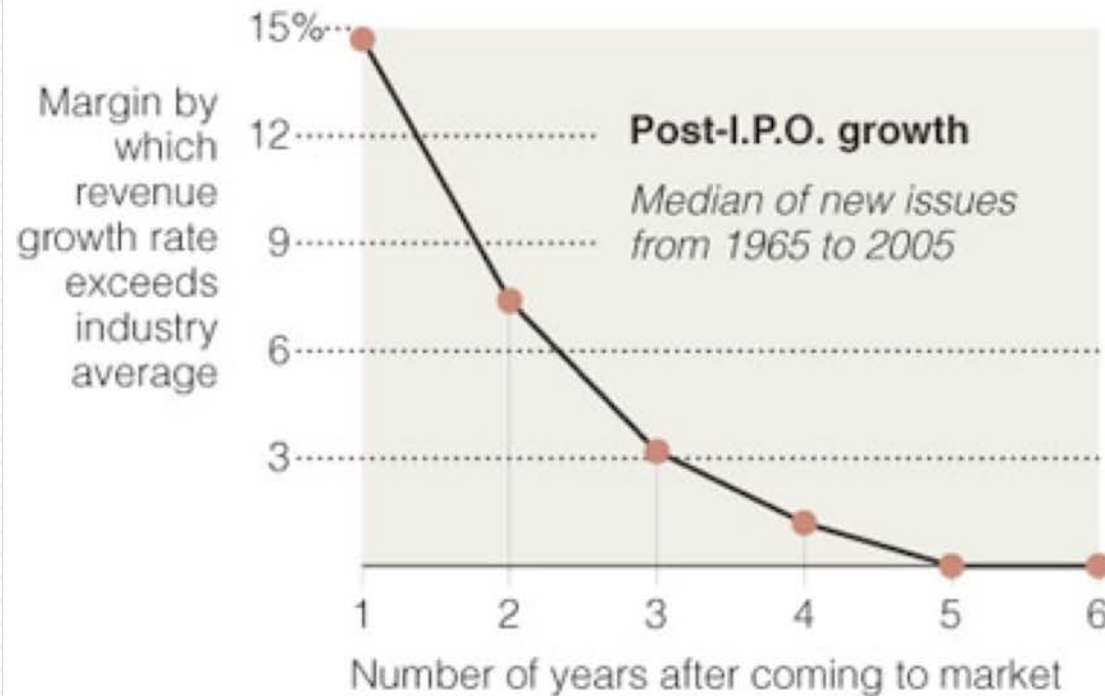

Source: Andrew Metrick

The New York Times

Lesson 4: Don't forget to pay for growth...

Year	Revenues	Δ Revenue	Sales/Cap	Δ Investment	Invested Capital	EBIT (1-t)	Imputed ROC
Tr 12 mths	\$1,117				\$ 487	-\$410	
1	\$2,793	\$1,676	3.00	\$559	\$ 1,045	-\$373	-76.62%
2	\$5,585	\$2,793	3.00	\$931	\$ 1,976	-\$94	-8.96%
3	\$9,774	\$4,189	3.00	\$1,396	\$ 3,372	\$407	20.59%
4	\$14,661	\$4,887	3.00	\$1,629	\$ 5,001	\$871	25.82%
5	\$19,059	\$4,398	3.00	\$1,466	\$ 6,467	\$1,058	21.16%
6	\$23,862	\$4,803	3.00	\$1,601	\$ 8,068	\$1,438	22.23%
7	\$28,729	\$4,868	3.00	\$1,623	\$ 9,691	\$1,799	22.30%
8	\$33,211	\$4,482	3.00	\$1,494	\$ 11,185	\$2,119	21.87%
9	\$36,798	\$3,587	3.00	\$1,196	\$ 12,380	\$2,370	21.19%
10	\$39,006	\$2,208	3.00	\$736	\$ 13,116	\$2,524	20.39%
TY	\$41,346	\$2,340	NA		Assumed to be =		20.00%

Lesson 5: There are always scenarios where the market price can be justified...

		Target pre-tax Operating Margin				
		6%	8%	10%	12%	14%
Compounded annual Revenue Growth rate	30%	\$ (1.94)	\$ 2.95	\$ 7.84	\$ 12.71	\$ 17.57
	35%	\$ 1.41	\$ 8.37	\$ 15.33	\$ 22.27	\$ 29.21
	40%	\$ 6.10	\$ 15.93	\$ 25.74	\$ 35.54	\$ 45.34
	45%	\$ 12.59	\$ 26.34	\$ 40.05	\$ 53.77	\$ 67.48
	50%	\$ 21.47	\$ 40.50	\$ 59.52	\$ 78.53	\$ 97.54
	55%	\$ 33.47	\$ 59.60	\$ 85.72	\$ 111.84	\$ 137.95
	60%	\$ 49.53	\$ 85.10	\$ 120.66	\$ 156.22	\$ 191.77

Lesson 6: Don't forget to mop up...

- Watch out for “other” equity claims: If you buy equity in a young, growth company, watch out for other (often hidden) claims on the equity that don't take the form of common shares. In particular, watch for options granted to managers, employees, venture capitalists and others (you will be surprised...).
 - ▣ Value these options as options (not at exercise value)
 - ▣ Take into consideration expectations of future option grants when computing expected future earnings/cash flows.
- Not all shares are equal: If there are differences in cash flow claims (dividends or liquidation) or voting rights across shares, value these differences.
 - ▣ Voting rights matter even at well run companies

Lesson 7: You will be wrong 100% of the time... and it really is not (always) your fault...

- No matter how careful you are in getting your inputs and how well structured your model is, your estimate of value will change both as new information comes out about the company, the business and the economy.
- As information comes out, you will have to adjust and adapt your model to reflect the information. Rather than be defensive about the resulting changes in value, recognize that this is the essence of risk.
- A test: If your valuations are unbiased, you should find yourself increasing estimated values as often as you are decreasing values. In other words, there should be equal doses of good and bad news affecting valuations (at least over time).

And the market is often “more wrong”

Amazon: Value and Price

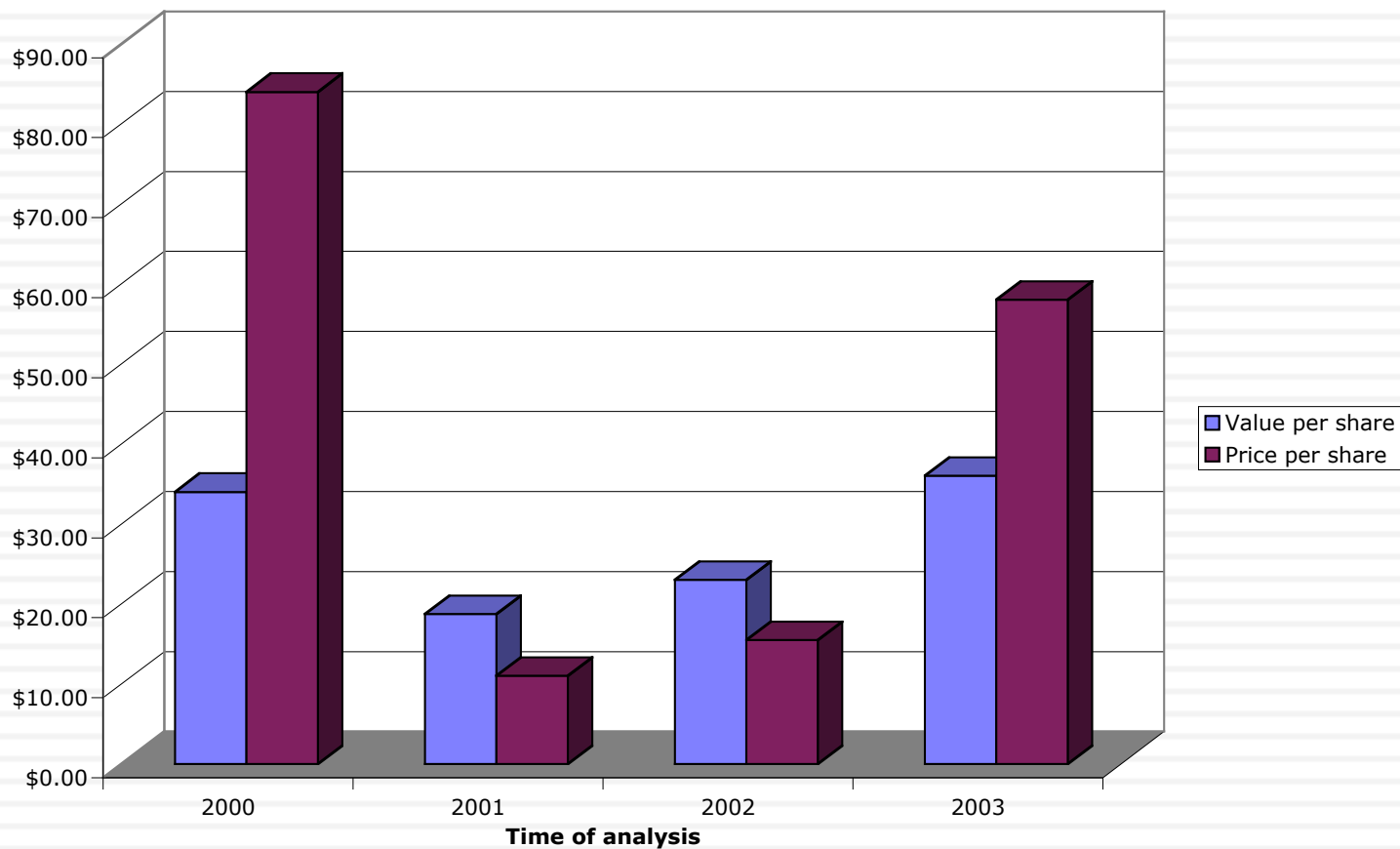

Valuing an IPO

- Valuation issues:
 - Use of the proceeds from the offering: The proceeds from the offering can be held as cash by the firm to cover future investment needs, paid to existing equity investors who want to cash out or used to pay down debt.
 - Warrants/ Special deals with prior equity investors: If venture capitalists and other equity investors from earlier iterations of fund raising have rights to buy or sell their equity at pre-specified prices, it can affect the value per share offered to the public.
- Pricing issues:
 - Institutional set-up: Most IPOs are backed by investment banking guarantees on the price, which can affect how they are priced.
 - Follow-up offerings: The proportion of equity being offered at initial offering and subsequent offering plans can affect pricing.

Alibaba: Pre-IPO valuation - September 2, 2014 (in US \$)

	T12M	2012-13
Revenues	\$9,268	\$4,821
Operating Income	\$4,702	\$1,777
Effective tax rate	11.92%	
Operating Margin	50.73%	

Revenue growth of 25% a year for 5 years, tapering down to 2.63% in year 10

Pre-tax operating margin decreases to 40% over time & tax rate rises to 25%

Sales to capital ratio maintained at 2.00

Stable Growth
 $g = 2.41\%$
 Cost of capital = 8%
 ROC = 8%;
 Reinvestment Rate = $2.41\%/8\% = 30.125\%$

Terminal Value₁₀ = $10,353 / (.08 - 0.0241) = \$185,198$

	1	2	3	4	5	6	7	8	9	10
Revenue growth rate	25.00%	25.00%	25.00%	25.00%	25.00%	20.48%	15.96%	11.45%	6.93%	2.41%
Revenues	\$ 11,585	\$ 14,481	\$ 18,101	\$ 22,626	\$ 28,283	\$ 34,075	\$ 39,515	\$ 44,038	\$ 47,089	\$ 48,224
EBIT (Operating) margin	49.66%	48.59%	47.51%	46.44%	45.37%	44.29%	43.22%	42.15%	41.07%	40.00%
EBIT (Operating income)	\$ 5,753	\$ 7,035	\$ 8,600	\$ 10,507	\$ 12,831	\$ 15,093	\$ 17,078	\$ 18,560	\$ 19,341	\$ 19,290
Tax rate	11.92%	11.92%	11.92%	11.92%	11.92%	14.54%	17.15%	19.77%	22.38%	25.00%
EBIT(1-t)	\$ 5,067	\$ 6,197	\$ 7,575	\$ 9,255	\$ 11,301	\$ 12,899	\$ 14,149	\$ 14,891	\$ 15,012	\$ 14,467
- Reinvestment	\$ 1,158	\$ 1,448	\$ 1,810	\$ 2,263	\$ 2,828	\$ 2,896	\$ 2,720	\$ 2,261	\$ 1,525	\$ 567
FCFF	\$ 3,908	\$ 4,749	\$ 5,765	\$ 6,992	\$ 8,473	\$ 10,002	\$ 11,429	\$ 12,630	\$ 13,486	\$ 13,900

Term yr
 EBIT (1-t) \$14,816
 - Reinv 4,463
 FCFF 10,353

Operating assets \$137,386
 + Cash 9330
 - Debt 10068
 + Equity investments 2,087
 + Alipay provision 3,000
 + IPO Proceeds (est) 20,000
 - Options 696
 Value of equity 161,039
 Value per share \$65.98

Cost of capital = $8.90\% (.943) + 3.00\% (.057) = 8.56\%$

Cost of capital decreases to 8% from years 6-10

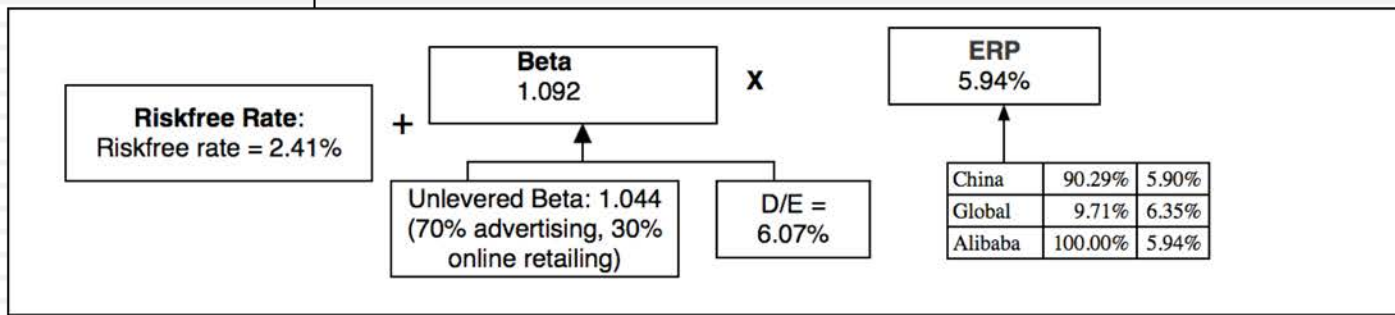
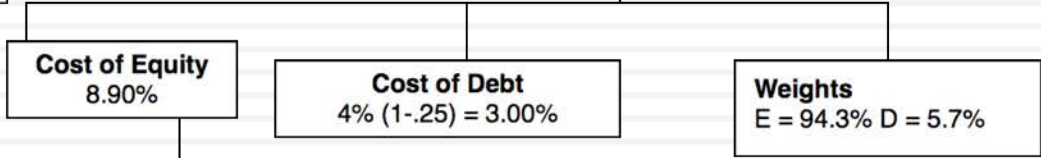

Two days after this valuation, the company (and its bankers) valued itself at about \$155 billion and the shares at \$63 apiece. The offering price was raised to \$69 and the opening price was \$93/share.

II. Mature Companies in transition..

- Mature companies are generally the easiest group to value. They have long, established histories that can be mined for inputs. They have investment policies that are set and capital structures that are stable, thus making valuation more grounded in past data.
- However, this stability in the numbers can mask real problems at the company. The company may be set in a process, where it invests more or less than it should and does not have the right financing mix. In effect, the policies are consistent, stable and bad.
- If you expect these companies to change or as is more often the case to have change thrust upon them,

The perils of valuing mature companies...

Figure 7.1: Estimation Issues - Mature Companies

Lots of historical data on earnings and cashflows. Key questions remain if these numbers are volatile over time or if the existing assets are not being efficiently utilized.

Growth is usually not very high, but firms may still be generating healthy returns on investments, relative to cost of funding. Questions include how long they can generate these excess returns and with what growth rate in operations. Restructuring can change both inputs dramatically and some firms maintain high growth through acquisitions.

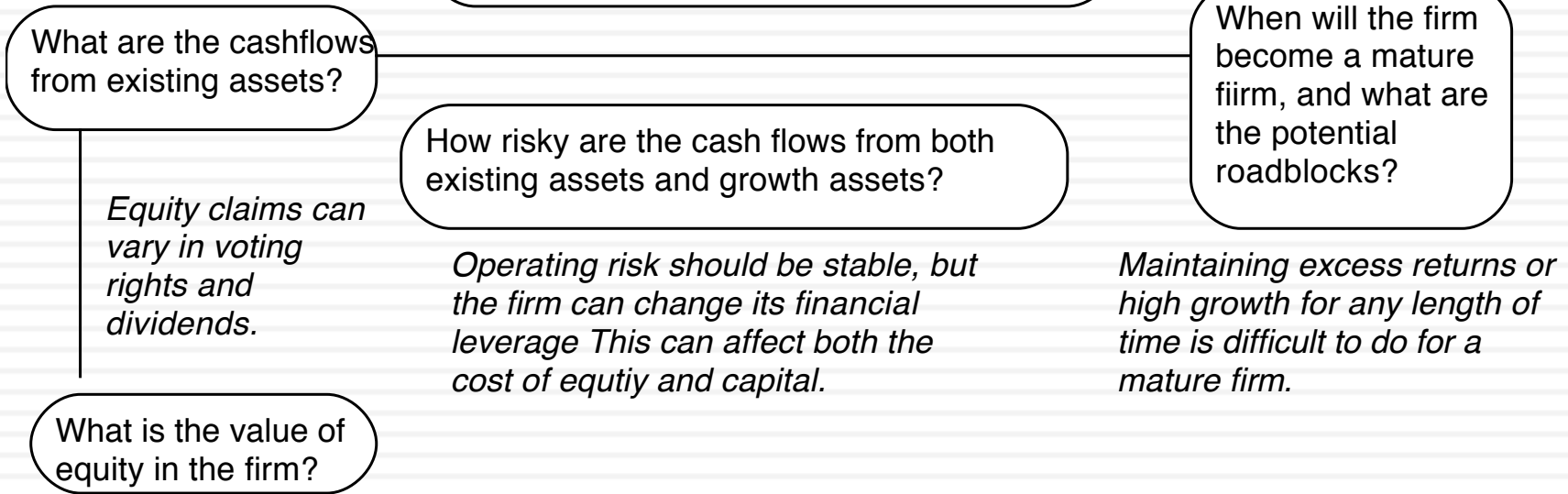

Equity claims can vary in voting rights and dividends.

How risky are the cash flows from both existing assets and growth assets?

Operating risk should be stable, but the firm can change its financial leverage. This can affect both the cost of equity and capital.

When will the firm become a mature firm, and what are the potential roadblocks?

Maintaining excess returns or high growth for any length of time is difficult to do for a mature firm.

Hormel Foods: The Value of Control Changing

Hormel Foods sells packaged meat and other food products and has been in existence as a publicly traded company for almost 80 years. In 2008, the firm reported after-tax operating income of \$315 million, reflecting a compounded growth of 5% over the previous 5 years.

The Status Quo

Run by existing management, with conservative reinvestment policies (reinvestment rate = 14.34% and debt ratio = 10.4%.

Anemic growth rate and short growth period, due to reinvestment policy

Low debt ratio affects cost of capital

Year	Operating income after taxes	Expected growth rate	ROC	Reinvestment Rate	Reinvestment	FCFF	Cost of capital	Present Value
Trailing 12 months	\$315							
1	\$324	2.75%	14.34%	19.14%	\$62	\$262	6.79%	\$245
2	\$333	2.75%	14.34%	19.14%	\$64	\$269	6.79%	\$236
3	\$342	2.75%	14.34%	19.14%	\$65	\$276	6.79%	\$227
Beyond	\$350	2.35%	7.23%	32.52%	\$114	\$4,840	7.23%	\$3,974
Value of operating assets								\$4,682
(Add) Cash								\$155
(Subtract) Debt								\$491
(Subtract) Management Options								\$53
Value of equity in common stock								\$4,293
Value per share								\$31.91

New and better management

More aggressive reinvestment which increases the reinvestment rate (to 40%) and tlength of growth (to 5 years), and higher debt ratio (20%).

Operating Restructuring (1)

Expected growth rate = $ROC \times \text{Reinvestment Rate}$
 Expected growth rate (status quo) = $14.34\% \times 19.14\% = 2.75\%$
 Expected growth rate (optimal) = $14.00\% \times 40\% = 5.60\%$
 ROC drops, reinvestment rises and growth goes up.

Financial restructuring (2)

Cost of capital = Cost of equity (1-Debt ratio) + Cost of debt (Debt ratio)
 Status quo = $7.33\% (1-.104) + 3.60\% (.104) = 6.79\%$
 Optimal = $7.75\% (1-.20) + 3.60\% (.20) = 6.63\%$
 Cost of equity rises but cost of capital drops.

Year	Operating income after taxes	Expected growth rate	ROC	Reinvestment Rate	Reinvestment	FCFF	Cost of capital	Present Value
Trailing 12 months	\$315							
1	\$333	5.60%	14.00%	40.00%	\$133	\$200	6.63%	\$187
2	\$351	5.60%	14.00%	40.00%	\$141	\$211	6.63%	\$185
3	\$371	5.60%	14.00%	40.00%	\$148	\$223	6.63%	\$184
4	\$392	5.60%	14.00%	40.00%	\$260	\$235	6.63%	\$182
5	\$414	5.60%	14.00%	40.00%	\$223	\$248	6.63%	\$180
Beyond	\$423	2.35%	6.74%	34.87%	\$148	\$6,282	6.74%	\$4,557
Value of operating assets								\$5,475
(Add) Cash								\$155
(Subtract) Debt								\$491
(Subtract) Management Options								\$53
Value of equity in common stock								\$5,085
Value per share								\$37.80

Aswath Damodaran

Probability of management change = 10%
 Expected value = $\$31.91 (.90) + \$37.80 (.10) = \$32.50$

(3)

(4)

Lesson 1: Cost cutting and increased efficiency are easier accomplished on paper than in practice...

Cost-synergy estimation is better, but there are patterns emerging in the errors

Mergers achieving stated percentage of expected cost savings, percent $N = 92$

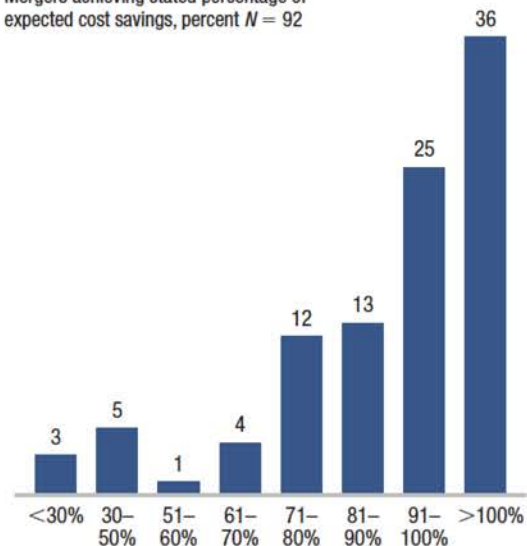

Typical sources of estimation error

- Underestimating one-time costs
- Using benchmarks from noncomparable situations
- Not sanity-checking management estimates against precedent transactions
- Failing to ground estimates in bottom-up analysis (e.g., location-by-location review of overlaps)

Source: McKinsey (2002) Postmerger Management Practice client survey; client case studies

Lesson 2: Increasing growth is not always an option (or at least not a good option)

**Modes of organic growth vary in value creation intensity—
consumer goods industry**

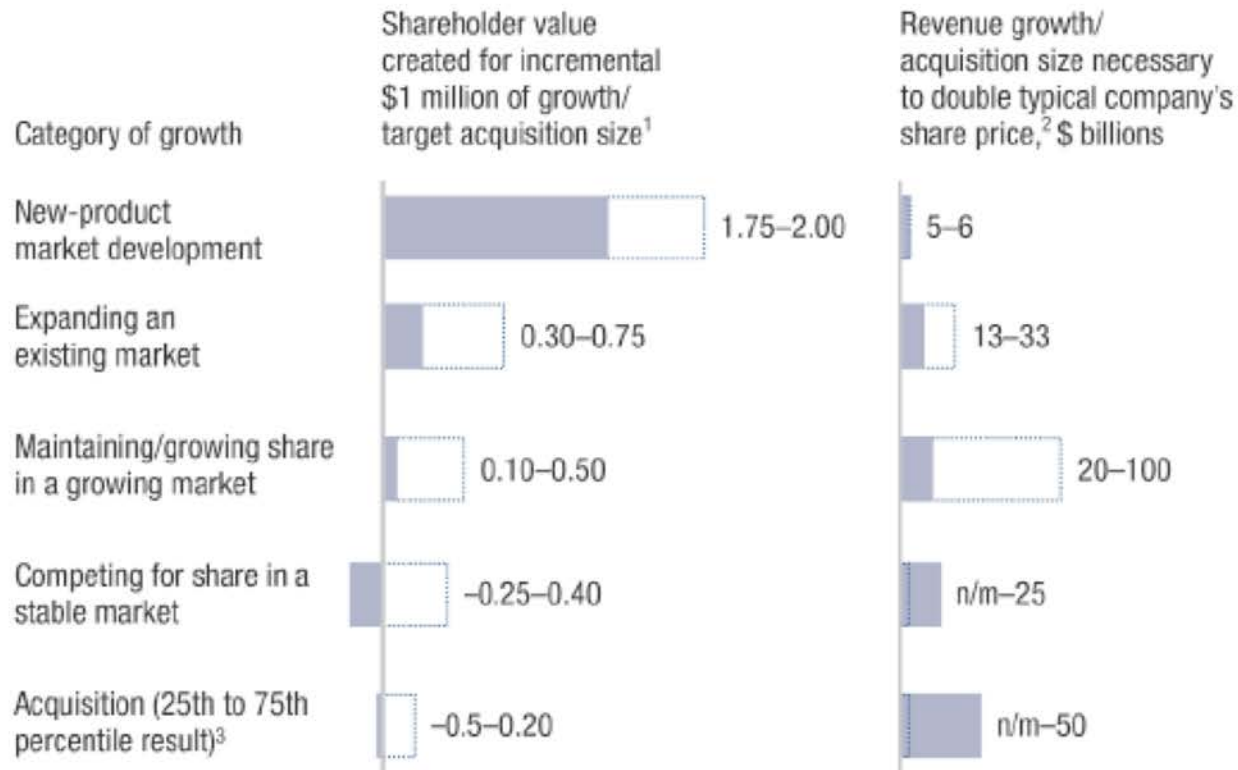

Lesson 3: Financial leverage is a double-edged sword..

Exhibit 7.1: Optimal Financing Mix: Hormel Foods in January 2009

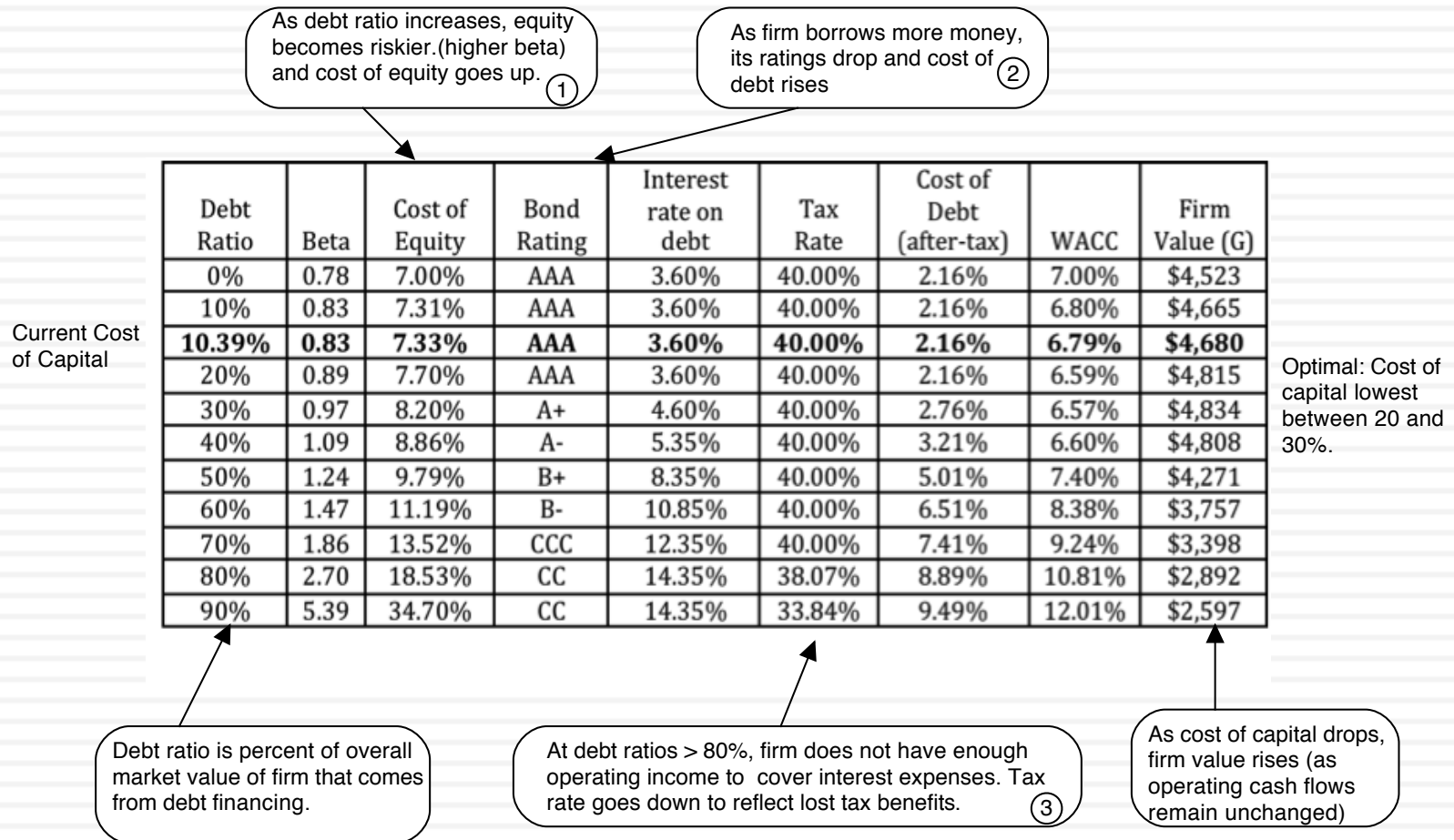

III. Dealing with decline and distress...

Historical data often reflects flat or declining revenues and falling margins. Investments often earn less than the cost of capital.

Growth can be negative, as firm sheds assets and shrinks. As less profitable assets are shed, the firm's remaining assets may improve in quality.

What is the value added by growth assets?

What are the cashflows from existing assets?

Underfunded pension obligations and litigation claims can lower value of equity. Liquidation preferences can affect value of equity

What is the value of equity in the firm?

How risky are the cash flows from both existing assets and growth assets?

Depending upon the risk of the assets being divested and the use of the proceeds from the divestiture (to pay dividends or retire debt), the risk in both the firm and its equity can change.

When will the firm become a mature firm, and what are the potential roadblocks?

There is a real chance, especially with high financial leverage, that the firm will not make it. If it is expected to survive as a going concern, it will be as a much smaller entity.

Dealing with the “downside” of Distress

- A DCF valuation values a firm as a going concern. If there is a significant likelihood of the firm failing before it reaches stable growth and if the assets will then be sold for a value less than the present value of the expected cashflows (a distress sale value), DCF valuations will understate the value of the firm.
- Value of Equity= DCF value of equity (1 - Probability of distress) + Distress sale value of equity (Probability of distress)
- There are three ways in which we can estimate the probability of distress:
 - Use the bond rating to estimate the cumulative probability of distress over 10 years
 - Estimate the probability of distress with a probit
 - Estimate the probability of distress by looking at market value of bonds..
- The distress sale value of equity is usually best estimated as a percent of book value (and this value will be lower if the economy is doing badly and there are other firms in the same business also in distress).

Current Revenue
\$ 4,390

Current Margin:
4.76%

Reinvestment:
Capital expenditures include cost of new casinos and working capital

Stable Growth
Stable Revenue Growth: 3%
Stable Operating Margin: 17%
Stable ROC=10% Reinvest 30% of EBIT(1-t)

EBIT
\$ 209m

Extended reinvestment break, due ot investment in past

Industry average

Expected Margin:
-> 17%

Terminal Value= $758 \cdot (.0743 \cdot .03)$
=\$ 17,129

Value of Op Assets \$ 9,793
+ Cash & Non-op \$ 3,040
= Value of Firm \$12,833
- Value of Debt \$ 7,565
= Value of Equity \$ 5,268

Value per share \$ 8.12

		1	2	3	4	5	6	7	8	9	10	Term. Year
Revenues		\$4,434	\$4,523	\$5,427	\$6,513	\$7,815	\$8,206	\$8,616	\$9,047	\$9,499	\$9,974	\$10,273
Oper margin		5.81%	6.86%	7.90%	8.95%	10%	11.40%	12.80%	14.20%	15.60%	17%	17%
EBIT		\$258	\$310	\$429	\$583	\$782	\$935	\$1,103	\$1,285	\$1,482	\$1,696	\$1,746
Tax rate		26.0%	26.0%	26.0%	26.0%	26.0%	28.4%	30.8%	33.2%	35.6%	38.00%	38%
EBIT * (1 - t)		\$191	\$229	\$317	\$431	\$578	\$670	\$763	\$858	\$954	\$1,051	\$1,083
- Reinvestment		-\$19	-\$11	\$0	\$22	\$58	\$67	\$153	\$215	\$286	\$350	\$325
FCFF		\$210	\$241	\$317	\$410	\$520	\$603	\$611	\$644	\$668	\$701	\$758
Beta		3.14	3.14	3.14	3.14	3.14	2.75	2.36	1.97	1.59	1.20	Forever
Cost of equity		21.82%	21.82%	21.82%	21.82%	21.82%	19.50%	17.17%	14.85%	12.52%	10.20%	
Cost of debt		9%	9%	9%	9%	9%	8.70%	8.40%	8.10%	7.80%	7.50%	
Debt/ratio		73.50%	73.50%	73.50%	73.50%	73.50%	68.80%	64.10%	59.40%	54.70%	50.00%	
Cost of capital		9.88%	9.88%	9.88%	9.88%	9.88%	9.79%	9.50%	9.01%	8.32%	7.43%	

Cost of Equity
21.82%

Cost of Debt
 $3\% + 6\% = 9\%$
 $9\% (1 - .38) = 5.58\%$

Weights
Debt= 73.5% ->50%

Riskfree Rate:
T. Bond rate = 3%

Aswath Damodaran

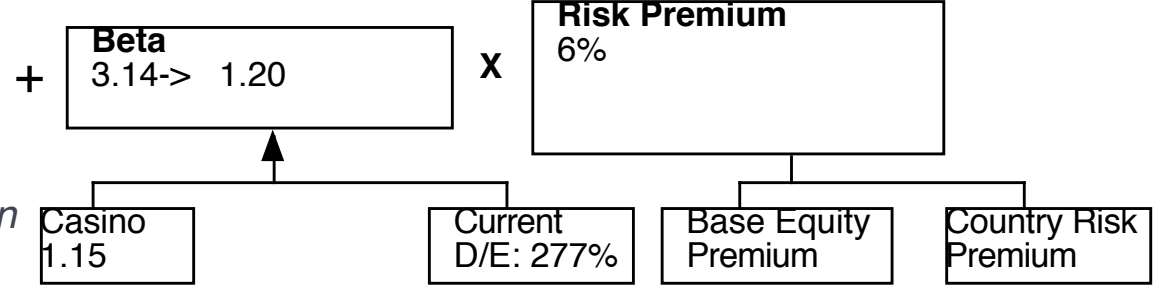

Las Vegas Sands
Feburary 2009
Trading @ \$4.25

Adjusting the value of LVS for distress..

- In February 2009, LVS was rated B+ by S&P. Historically, 28.25% of B+ rated bonds default within 10 years. LVS has a 6.375% bond, maturing in February 2015 (7 years), trading at \$529. If we discount the expected cash flows on the bond at the riskfree rate, we can back out the probability of distress from the bond price:

$$529 = \sum_{t=1}^{t=7} \frac{63.75(1 - \Pi_{\text{Distress}})^t}{(1.03)^t} + \frac{1000(1 - \Pi_{\text{Distress}})^7}{(1.03)^7}$$

- Solving for the probability of bankruptcy, we get:
- π_{Distress} = Annual probability of default = 13.54%
 - Cumulative probability of surviving 10 years = $(1 - .1354)^{10} = 23.34\%$
 - Cumulative probability of distress over 10 years = $1 - .2334 = .7666$ or 76.66%
- If LVS is becomes distressed:
 - Expected distress sale proceeds = \$2,769 million < Face value of debt
 - Expected equity value/share = \$0.00
- Expected value per share = $\$8.12 (1 - .7666) + \$0.00 (.7666) = \$1.92$

The “sunny” side of distress: Equity as a call option to liquidate the firm

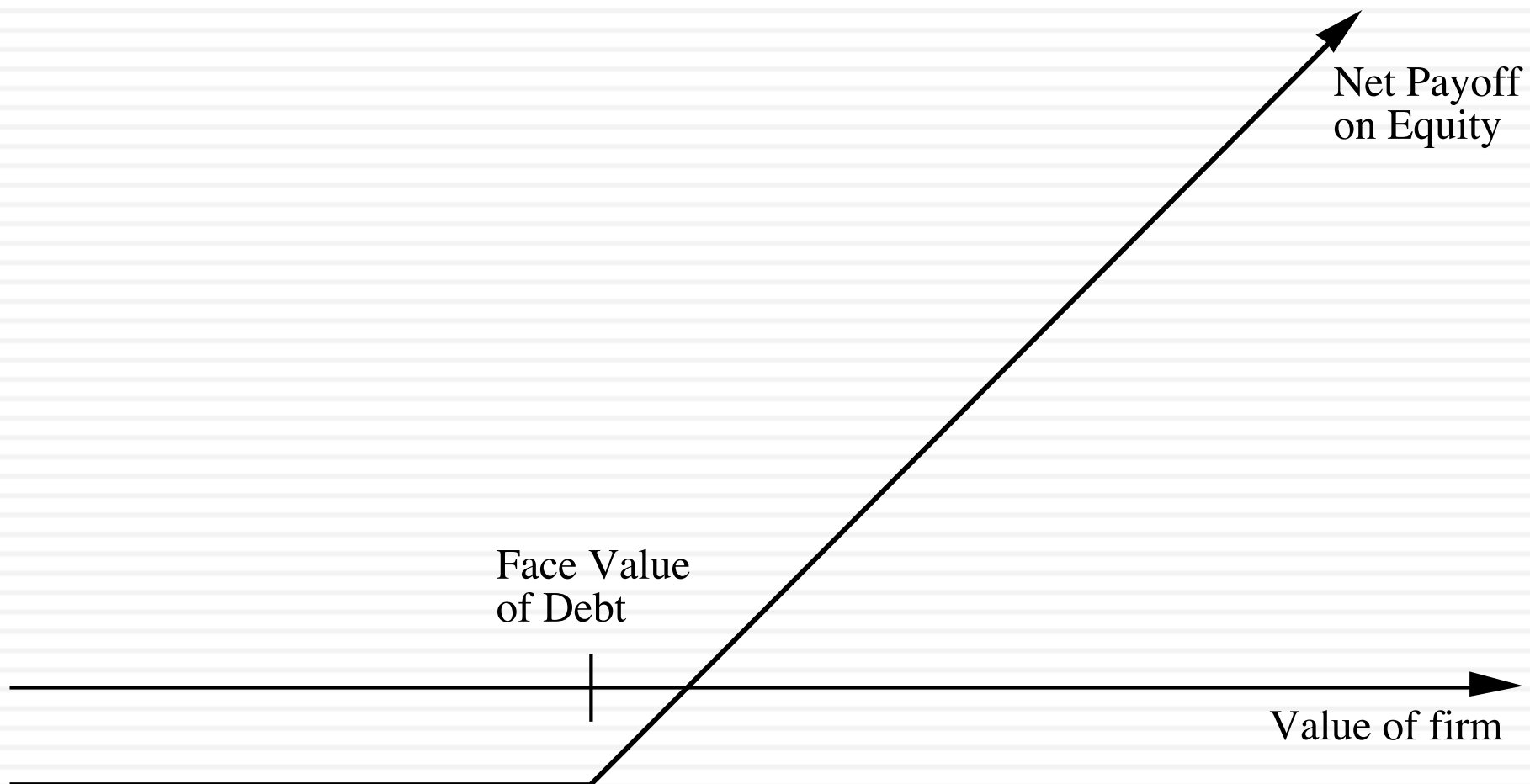

Application to valuation: A simple example

- Assume that you have a firm whose assets are currently valued at \$100 million and that the standard deviation in this asset value is 40%.
- Further, assume that the face value of debt is \$80 million (It is zero coupon debt with 10 years left to maturity).
- If the ten-year treasury bond rate is 10%,
 - ▣ how much is the equity worth?
 - ▣ What should the interest rate on debt be?

Model Parameters & Valuation

□ The inputs

- Value of the underlying asset = S = Value of the firm = \$ 100 million
- Exercise price = K = Face Value of outstanding debt = \$ 80 million
- Life of the option = t = Life of zero-coupon debt = 10 years
- Variance in the value of the underlying asset = σ^2 = Variance in firm value = 0.16
- Riskless rate = r = Treasury bond rate corresponding to option life = 10%

□ The output

- The Black-Scholes model provides the following value for the call:
 - $d1 = 1.5994$ $N(d1) = 0.9451$
 - $d2 = 0.3345$ $N(d2) = 0.6310$
- Value of the call = $100 (0.9451) - 80 \exp^{(-0.10)(10)} (0.6310) = \75.94 million
- Value of the outstanding debt = $\$100 - \$75.94 = \$24.06$ million
- Interest rate on debt = $(\$ 80 / \$24.06)^{1/10} - 1 = 12.77\%$

Firm value drops..

- Assume now that a catastrophe wipes out half the value of this firm (the value drops to \$ 50 million), while the face value of the debt remains at \$ 80 million.
- The inputs
 - Value of the underlying asset = S = Value of the firm = \$ 50 million
 - All the other inputs remain unchanged
- The output
 - Based upon these inputs, the Black-Scholes model provides the following value for the call:
 - $d1 = 1.0515$ $N(d1) = 0.8534$
 - $d2 = -0.2135$ $N(d2) = 0.4155$
 - Value of the call = $50 (0.8534) - 80 \exp^{(-0.10)(10)} (0.4155) = \30.44 million
 - Value of the bond = $\$50 - \$30.44 = \$19.56$ million

Equity value persists .. As firm value declines..

Value of Equity as Firm Value Changes

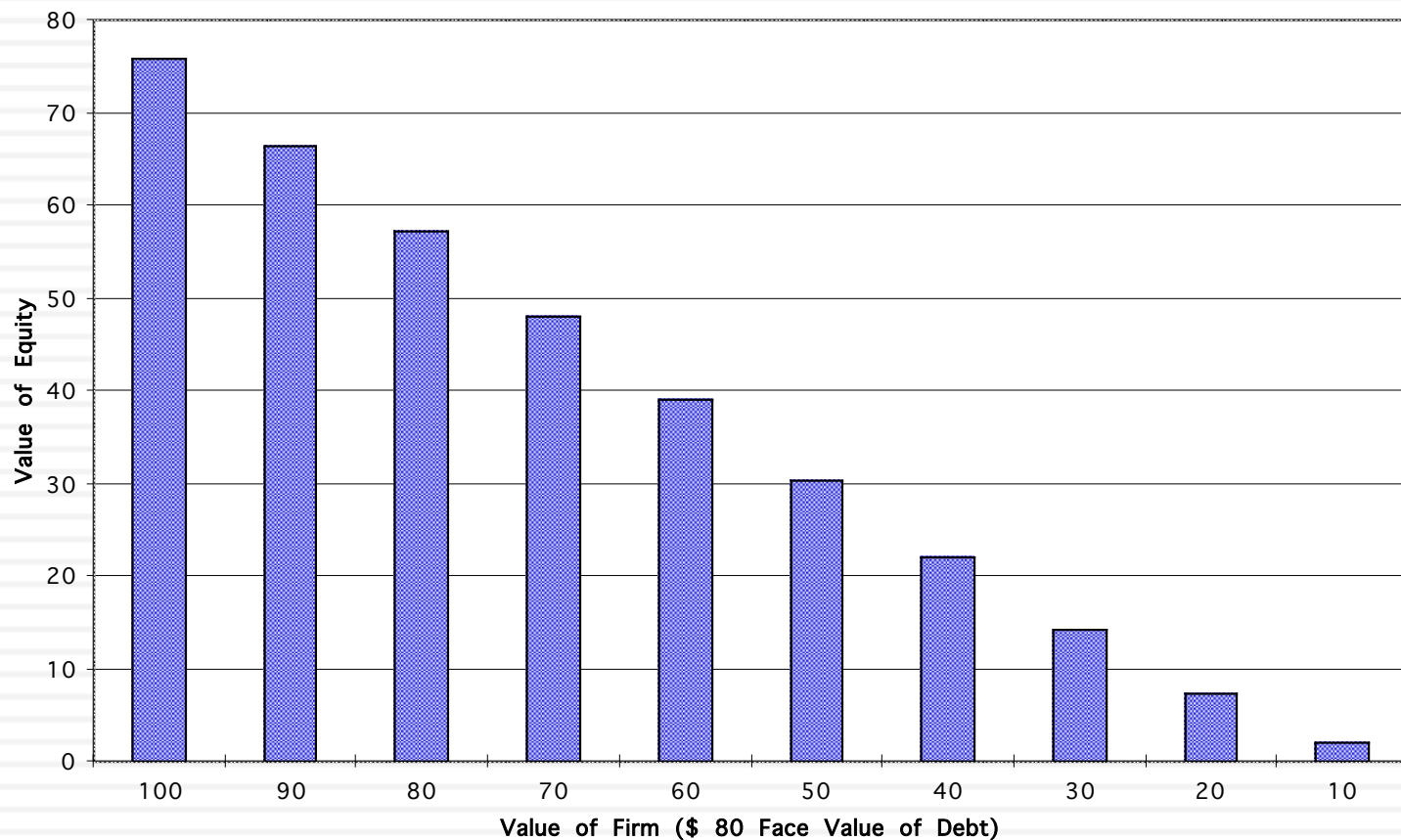

IV. Valuing Financial Service Companies

Existing assets are usually financial assets or loans, often marked to market. Earnings do not provide much information on underlying risk.

What are the cashflows from existing assets?

Preferred stock is a significant source of capital.

What is the value of equity in the firm?

Defining capital expenditures and working capital is a challenge. Growth can be strongly influenced by regulatory limits and constraints. Both the amount of new investments and the returns on these investments can change with regulatory changes.

What is the value added by growth assets?

How risky are the cash flows from both existing assets and growth assets?

For financial service firms, debt is raw material rather than a source of capital. It is not only tough to define but if defined broadly can result in high financial leverage, magnifying the impact of small operating risk changes on equity risk.

When will the firm become a mature firm, and what are the potential roadblocks?

In addition to all the normal constraints, financial service firms also have to worry about maintaining capital ratios that are acceptable to regulators. If they do not, they can be taken over and shut down.

CIB Egypt in December 2015

Valuation in Egyptian Pounds

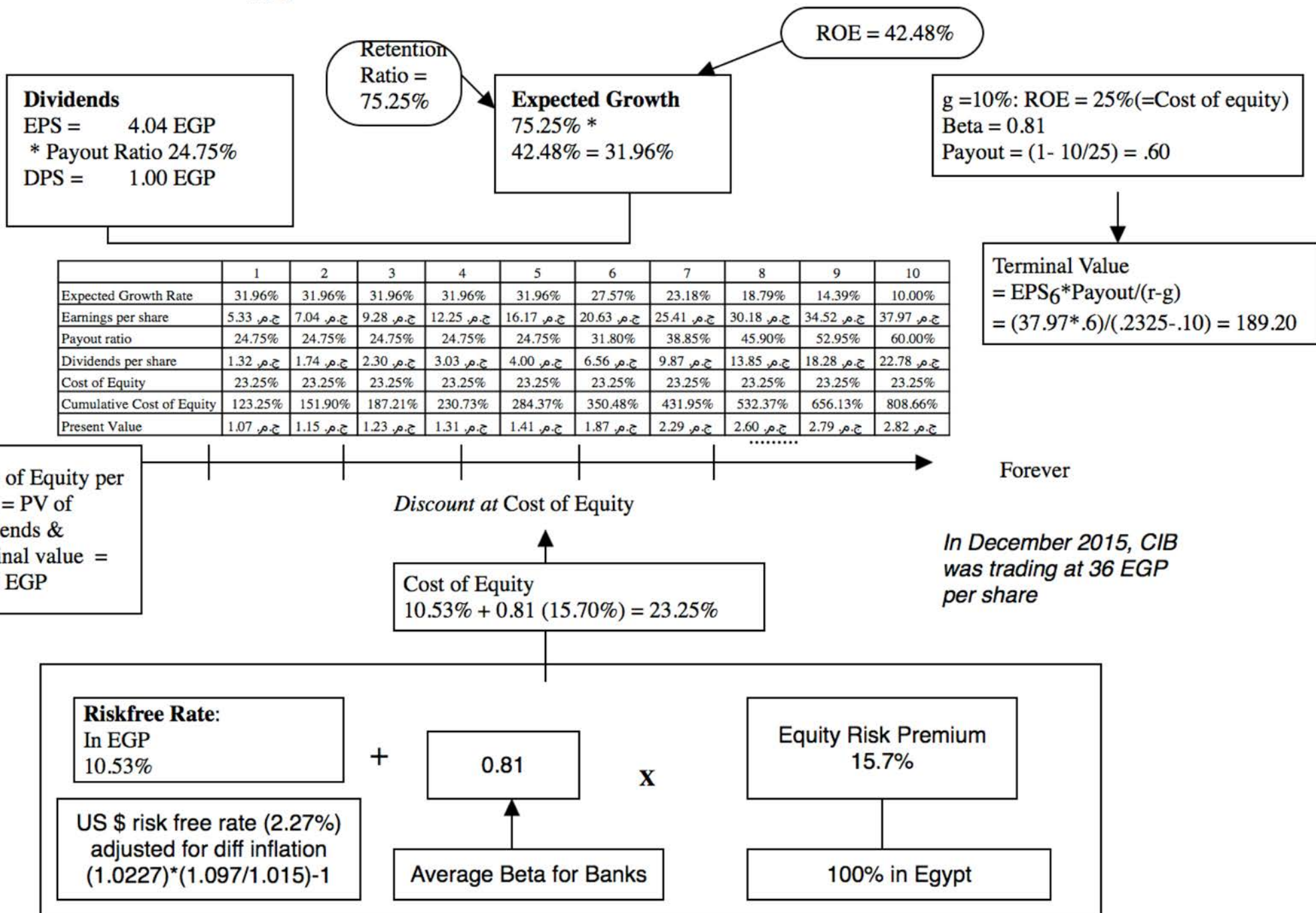

Lesson 1: Financial service companies are opaque...

- With financial service firms, we enter into a Faustian bargain. They tell us very little about the quality of their assets (loans, for a bank, for instance are not broken down by default risk status) but we accept that in return for assets being marked to market (by accountants who presumably have access to the information that we don't have).
- In addition, estimating cash flows for a financial service firm is difficult to do. So, we trust financial service firms to pay out their cash flows as dividends. Hence, the use of the dividend discount model.

Lesson 2: For financial service companies, book value matters...

- The book value of assets and equity is mostly irrelevant when valuing non-financial service companies. After all, the book value of equity is a historical figure and can be nonsensical. (The book value of equity can be negative and is so for more than a 1000 publicly traded US companies)
- With financial service firms, book value of equity is relevant for two reasons:
 - Since financial service firms mark to market, the book value is more likely to reflect what the firms own right now (rather than a historical value)
 - The regulatory capital ratios are based on book equity. Thus, a bank with negative or even low book equity will be shut down by the regulators.
- From a valuation perspective, it therefore makes sense to pay heed to book value. In fact, you can argue that reinvestment for a bank is the amount that it needs to add to book equity to sustain its growth ambitions and safety requirements:
 - $FCFE = \text{Net Income} - \text{Reinvestment in regulatory capital (book equity)}$

Deutsche Bank: A Crisis Valuation (October 2016)

Risk adjusted assets grows at inflation rate of 1% a year forever.

Tier 1 capital ratio increases to 15.67%, the 75th percentile for all banks

Expected DOJ fine of \$10 billions lower Tier 1 capital today

Common Equity increases in tandem with Tier 1 capital

Cost of equity starts at 10.2% (75th percentile of banks) & decreases after year 5 to 9.44% (median across banks).

	Current	1	2	3	4	5	6	7	8	9	10
Risk Adjusted Assets	\$ 445,570	\$ 450,026	\$ 454,526	\$ 459,071	\$ 463,662	\$ 468,299	\$ 472,982	\$ 477,711	\$ 482,488	\$ 487,313	\$ 492,186
Tier 1 Capital Ratio	12.41%	13.74%	13.95%	14.17%	14.38%	14.60%	14.81%	15.03%	15.24%	15.46%	15.67%
Tier 1 Capital (Risk Adjusted Assets * Tier 1 Capital Ratio)	\$55,282	\$61,834	\$63,427	\$65,045	\$66,690	\$68,361	\$70,059	\$71,784	\$73,537	\$75,317	\$77,126
Change in regulatory capital (Tier 1)		\$6,552	\$1,593	\$1,619	\$1,645	\$1,671	\$1,698	\$1,725	\$1,753	\$1,780	\$1,809
Book Equity	\$64,609	\$71,161	\$72,754	\$74,372	\$76,017	\$77,688	\$79,386	\$81,111	\$82,864	\$84,644	\$86,453
Expected ROE	-13.70%	-7.18%	-2.84%	0.06%	1.99%	5.85%	6.568%	7.286%	8.004%	8.722%	9.440%
Net Income (Book Equity * ROE)	\$ (8,851)	\$ (5,111)	\$ (2,065)	\$ 43	\$ 1,512	\$ 4,545	\$ 5,214	\$ 5,910	\$ 6,632	\$ 7,383	\$ 8,161
- Investment in Regulatory Capital		\$ 6,552	\$ 1,593	\$ 1,619	\$ 1,645	\$ 1,671	\$ 1,698	\$ 1,725	\$ 1,753	\$ 1,780	\$ 1,809
FCFE		\$ (11,663)	\$ (3,658)	\$ (1,576)	\$ (133)	\$ 2,874	\$ 3,516	\$ 4,185	\$ 4,880	\$ 5,602	\$ 6,352
Terminal value of equity											\$87,317
Present value		\$ (10,583)	\$ (3,012)	\$ (1,178)	\$ (90)	\$ 1,768	\$ 1,966	\$ 2,129	\$ 2,262	\$ 2,370	\$ 36,207
Cost of equity	10.20%	10.20%	10.20%	10.20%	10.20%	10.20%	10.048%	9.896%	9.744%	9.592%	9.440%
Cumulative Cost of equity		1.1020	1.2144	1.3383	1.4748	1.6252	1.7885	1.9655	2.1570	2.3639	2.5871
Value of equity today =	\$31,838.74										
Number of shares outstanding =	1386.00										
DCF Value per share =	\$ 22.97										
Probability of equity wipeout	10.00%										
Adjusted value per share =	\$ 20.67										
Stock price on October 3, 2016 =	\$ 13.33										

Value per share adjusted for probability of catastrophic failure (bailout) resulting in complete loss of equity.

Return on equity increases to 5.85% (25th percentile of banks) in year 5 and 9.44% (cost of equity) in year 10

V. Valuing cyclical and commodity companies

Company growth often comes from movements in the economic cycle, for cyclical firms, or commodity prices, for commodity companies.

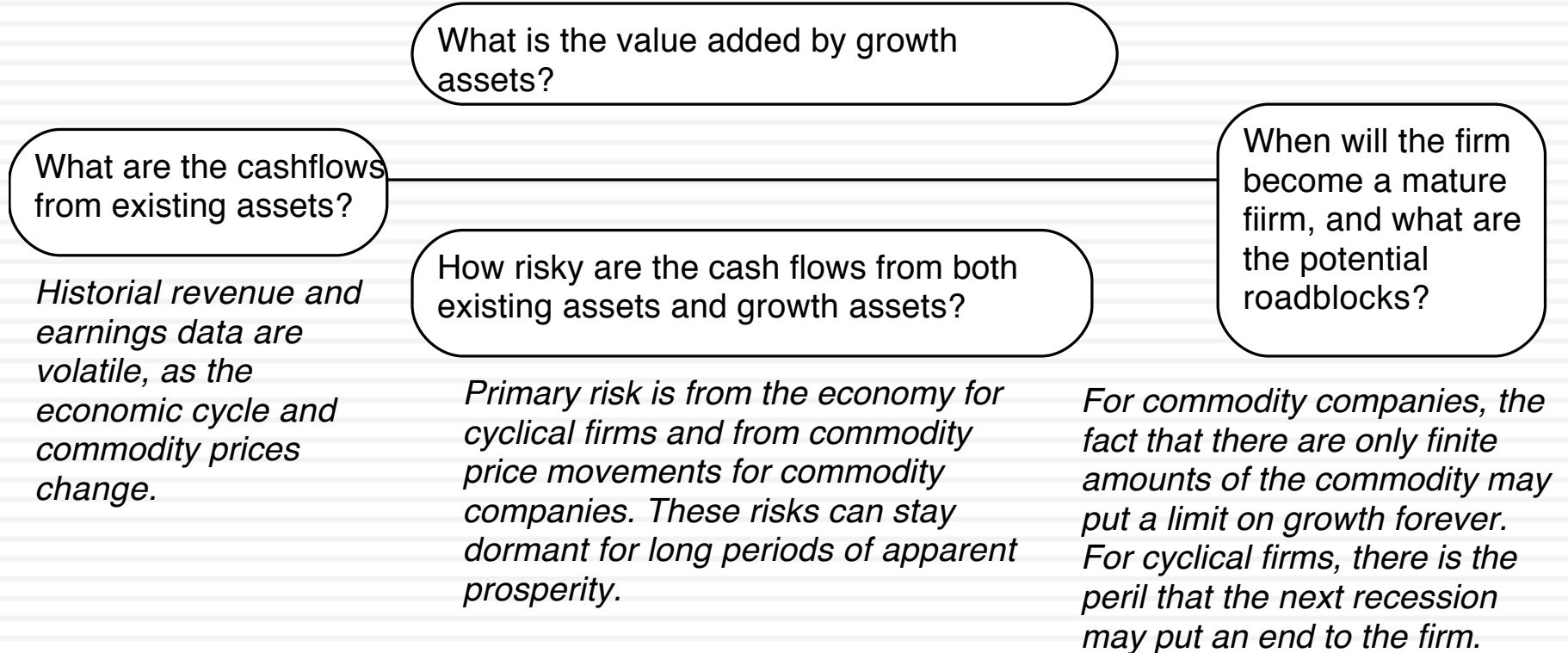

Valuing a Cyclical Company - Toyota in Early 2009

In early 2009, Toyota Motors had the highest market share in the sector. However, the global economic recession in 2008-09 had pulled earnings down.

Year	Revenues	Operating Inco	EBITDA	Operating Marg
FY1 1992	¥10,163,380	¥218,511	¥218,511	2.15%
FY1 1993	¥10,210,750	¥181,897	¥181,897	1.78%
FY1 1994	¥9,362,732	¥136,226	¥136,226	1.45%
FY1 1995	¥8,120,975	¥255,719	¥255,719	3.15%
FY1 1996	¥10,718,740	¥348,069	¥348,069	3.25%
FY1 1997	¥12,243,830	¥665,110	¥665,110	5.43%
FY1 1998	¥11,678,400	¥779,800	¥1,382,950	6.68%
FY1 1999	¥12,749,010	¥774,947	¥1,415,997	6.08%
FY1 2000	¥12,879,560	¥775,982	¥1,430,982	6.02%
FY1 2001	¥13,424,420	¥870,131	¥1,542,631	6.48%
FY1 2002	¥15,106,300	¥1,123,475	¥1,822,975	7.44%
FY1 2003	¥16,054,290	¥1,363,680	¥2,101,780	8.49%
FY1 2004	¥17,294,760	¥1,666,894	¥2,454,994	9.64%
FY1 2005	¥18,551,530	¥1,672,187	¥2,447,987	9.01%
FY1 2006	¥21,036,910	¥1,878,342	¥2,769,742	8.93%
FY1 2007	¥23,948,090	¥2,238,683	¥3,185,683	9.35%
FY1 2008	¥26,289,240	¥2,270,375	¥3,312,775	8.64%
FY 2009 (Estin	¥22,661,325	¥267,904	¥1,310,304	1.18%
		¥1,306,867		7.33%

Normalized Earnings ①

As a cyclical company, Toyota's earnings have been volatile and 2009 earnings reflect the troubled global economy. We will assume that when economic growth returns, the operating margin for Toyota will revert back to the historical average.

Normalized Operating Income = Revenues in 2009 * Average Operating Margin (98--09)
 = 22661 * .0733 = 1660.7 billion yen

Normalized Return on capital and Reinvestment ②

Once earnings bounce back to normal, we assume that Toyota will be able to earn a return on capital equal to its cost of capital (5.09%). This is a sector, where earning excess returns has proved to be difficult even for the best of firms.

To sustain a 1.5% growth rate, the reinvestment rate has to be:

$$\text{Reinvestment rate} = 1.5\% / 5.09\% = 29.46\%$$

Operating Assets	19,640
+ Cash	2,288
+ Non-operating assets	6,845
- Debt	11,862
- Minority Interests	583
Value of Equity	
/ No of shares	/3,448
Value per share	¥4735

$$\text{Value of operating assets} = \frac{1660.7 (1.015) (1 - .407) (1 - .2946)}{(.0509 - .015)} = 19,640 \text{ billion}$$

Normalized Cost of capital ③

The cost of capital is computed using the average beta of automobile companies (1.10), and Toyota's cost of debt (3.25%) and debt ratio (52.9% debt ratio. We use the Japanese marginal tax rate of 40.7% for computing both the after-tax cost of debt and the after-tax operating income

$$\text{Cost of capital} = 8.65\% (.471) + 3.25\% (1 - .407) (.529) = 5.09\%$$

Aswath Damodaran

Stable Growth ④

Once earnings are normalized, we assume that Toyota, as the largest market-share company, will be able to maintain only stable growth (1.5% in Yen terms)

Lesson 1: With “macro” companies, it is easy to get lost in “macro” assumptions...

- With cyclical and commodity companies, it is undeniable that the value you arrive at will be affected by your views on the economy or the price of the commodity.
- Consequently, you will feel the urge to take a stand on these macro variables and build them into your valuation. Doing so, though, will create valuations that are jointly impacted by your views on macro variables and your views on the company, and it is difficult to separate the two.
- The best (though not easiest) thing to do is to separate your macro views from your micro views. Use current market based numbers for your valuation, but then provide a separate assessment of what you think about those market numbers.

Shell's Revenues & Oil Prices

Shell: Revenues vs Oil Price

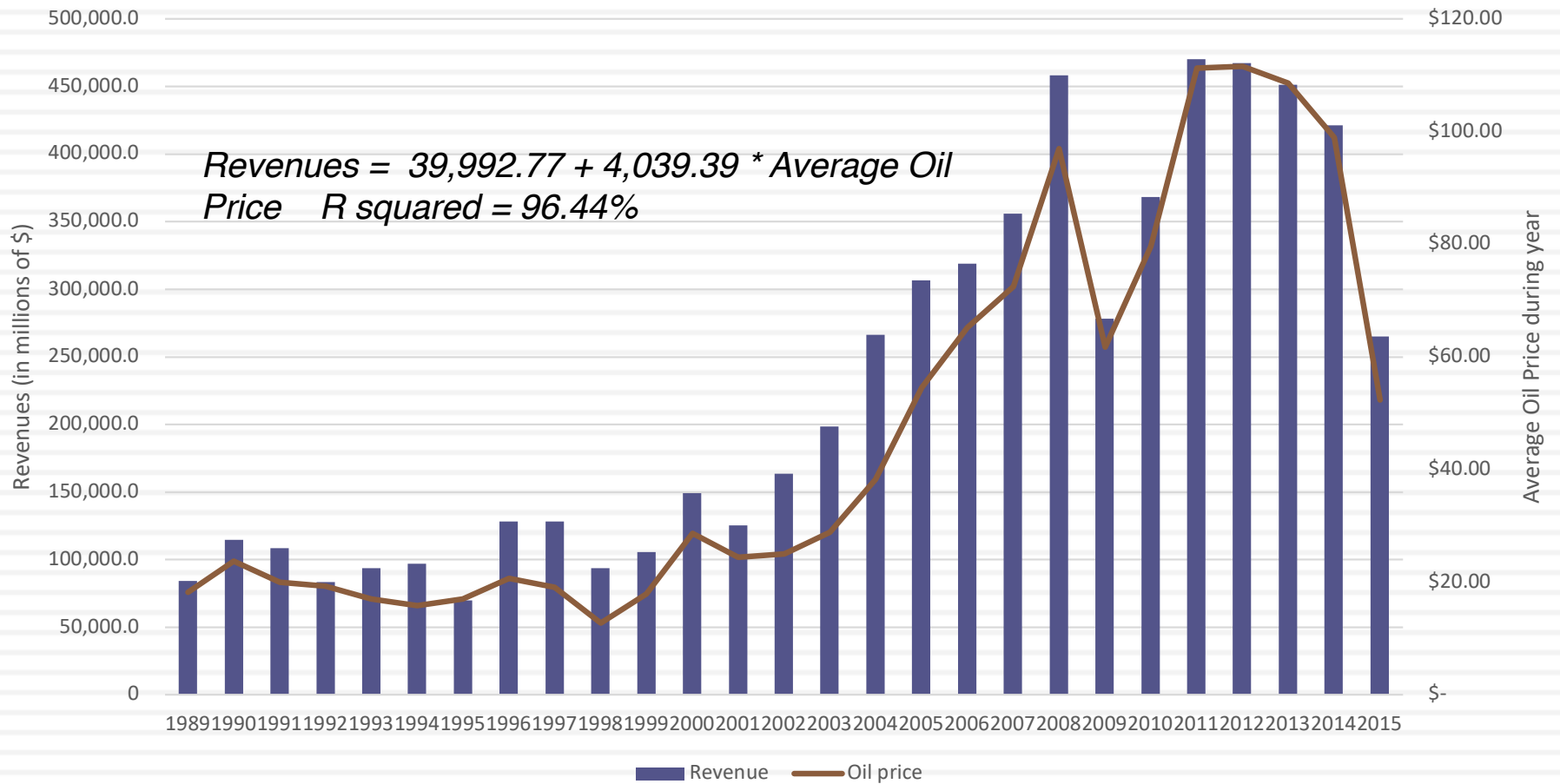

Shell: A "Oil Price" Neutral Valuation: March 2016

Revenue calculated from prevailing oil price of \$40/barrel in March 2016
 Revenue = 39992.77+4039.40*\$40
 = \$201,569

Compounded revenue growth of 3.91% a year, based on Shell's historical revenue growth rate from 2000 to 2015

	Base Year	1	2	3	4	5	Terminal Year
Revenues	\$ 201,569	\$ 209,450	\$ 217,639	\$ 226,149	\$ 234,991	\$ 244,180	\$ 249,063
Operating Margin	3.01%	6.18%	7.76%	8.56%	8.95%	9.35%	9.35%
Operating Income	\$ 6,065.00	\$ 12,942.85	\$ 16,899.10	\$ 19,352.39	\$ 21,040.39	\$ 22,830.80	\$ 23,287.41
Effective tax rate	30.00%	30.00%	30.00%	30.00%	30.00%	30.00%	30.00%
AT Operating Income	\$ 4,245.50	\$ 9,060.00	\$ 11,829.37	\$ 13,546.68	\$ 14,728.27	\$ 15,981.56	\$ 16,301.19
+ Depreciation	\$ 26,714.00	\$ 27,759	\$ 28,844	\$ 29,972	\$ 31,144	\$ 32,361	
- Cap Ex	\$ 31,854.00	\$ 33,099	\$ 34,394	\$ 35,738	\$ 37,136	\$ 38,588	
- Chg in WC		\$ 472.88	\$ 491.37	\$ 510.58	\$ 530.55	\$ 551.29	
FCFF		\$ 3,246.14	\$ 5,788.19	\$ 7,269.29	\$ 8,205.44	\$ 9,203.68	\$ 13,011.34
Terminal Value						\$ 216,855.71	
Return on capital							12.37%
Cost of Capital		9.91%	9.91%	9.91%	9.91%	9.91%	8.00%
Cumulated Discount Factor		1.0991	1.2080	1.3277	1.4593	1.6039	
Present Value		\$ 2,953.45	\$ 4,791.47	\$ 5,474.95	\$ 5,622.81	\$ 140,940.73	
Value of Operating Assets	\$ 159,783.41						
+ Cash	\$ 31,752.00						
+ Cross Holdings	\$ 33,566.00						
- Debt	\$ 58,379.00						
- Minority Interests	\$ 1,245.00						
Value of Equity	\$ 165,477.41						
Number of shares	4209.7						
Value per share	\$ 39.31						

Operating margin converges on Shell's historical average margin of 9.35% from 200-2015

Return on capital reverts and stays at Shell's historic average of 12.37% from 200-2015

Added long term investments in joint ventures and subtracted out minority interest in consolidated holdings.

Lesson 2: Use probabilistic tools to assess value as a function of macro variables...

- If there is a key macro variable affecting the value of your company that you are uncertain about (and who is not), why not quantify the uncertainty in a distribution (rather than a single price) and use that distribution in your valuation.
- That is exactly what you do in a Monte Carlo simulation, where you allow one or more variables to be distributions and compute a distribution of values for the company.
- With a simulation, you get not only everything you would get in a standard valuation (an estimated value for your company) but you will get additional output (on the variation in that value and the likelihood that your firm is under or over valued)

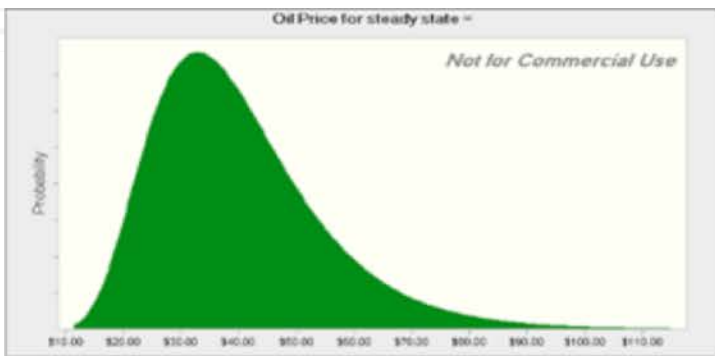

Revenue calculated from the oil price drawn from distribution
 $Revenue = 39992.77 + 4039.40 * Oil\ Price/Barrel$

Pre-tax Operating Income based on revenue & selected margin
 $Pre-tax\ Operating\ Income = Revenues * Operating\ Margin$



Value Shell based on operating income, assuming other assumptions (tax rate, revenue growth, cost of capital)

Percentiles:	Forecast values
0%	\$6.55
10%	\$23.90
20%	\$27.73
30%	\$30.89
40%	\$33.88
50%	\$36.99
60%	\$40.28
70%	\$44.22
80%	\$49.24
90%	\$57.49
100%	\$197.11

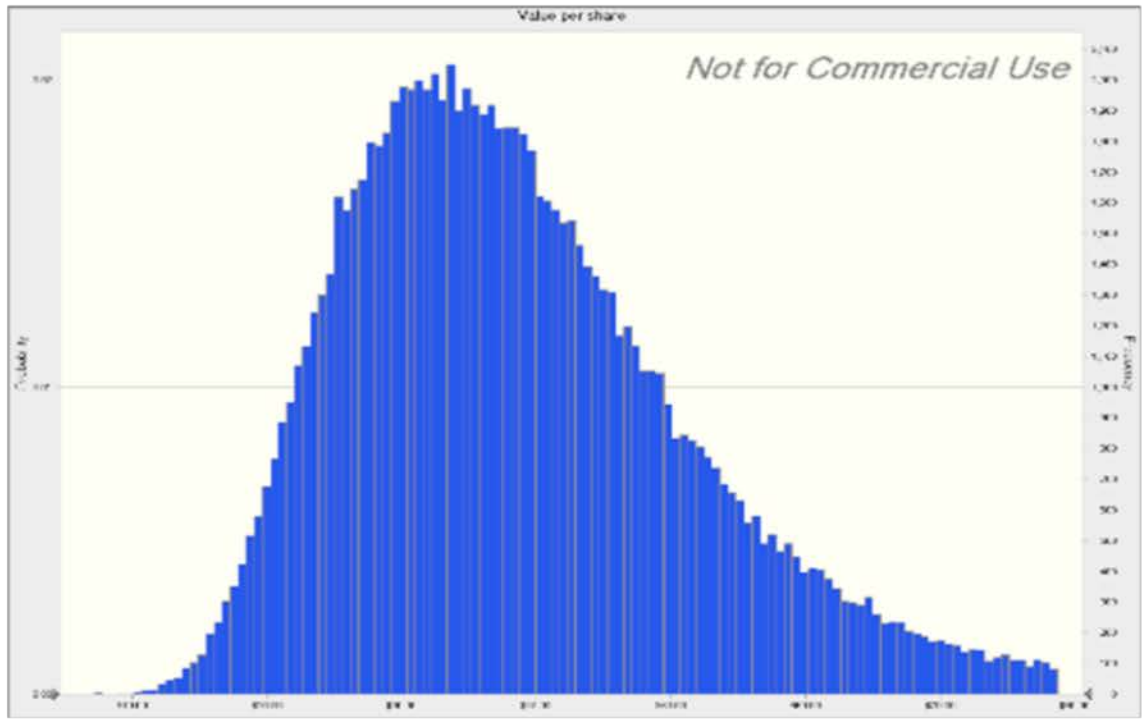

The optionality in commodities: Undeveloped reserves as an option

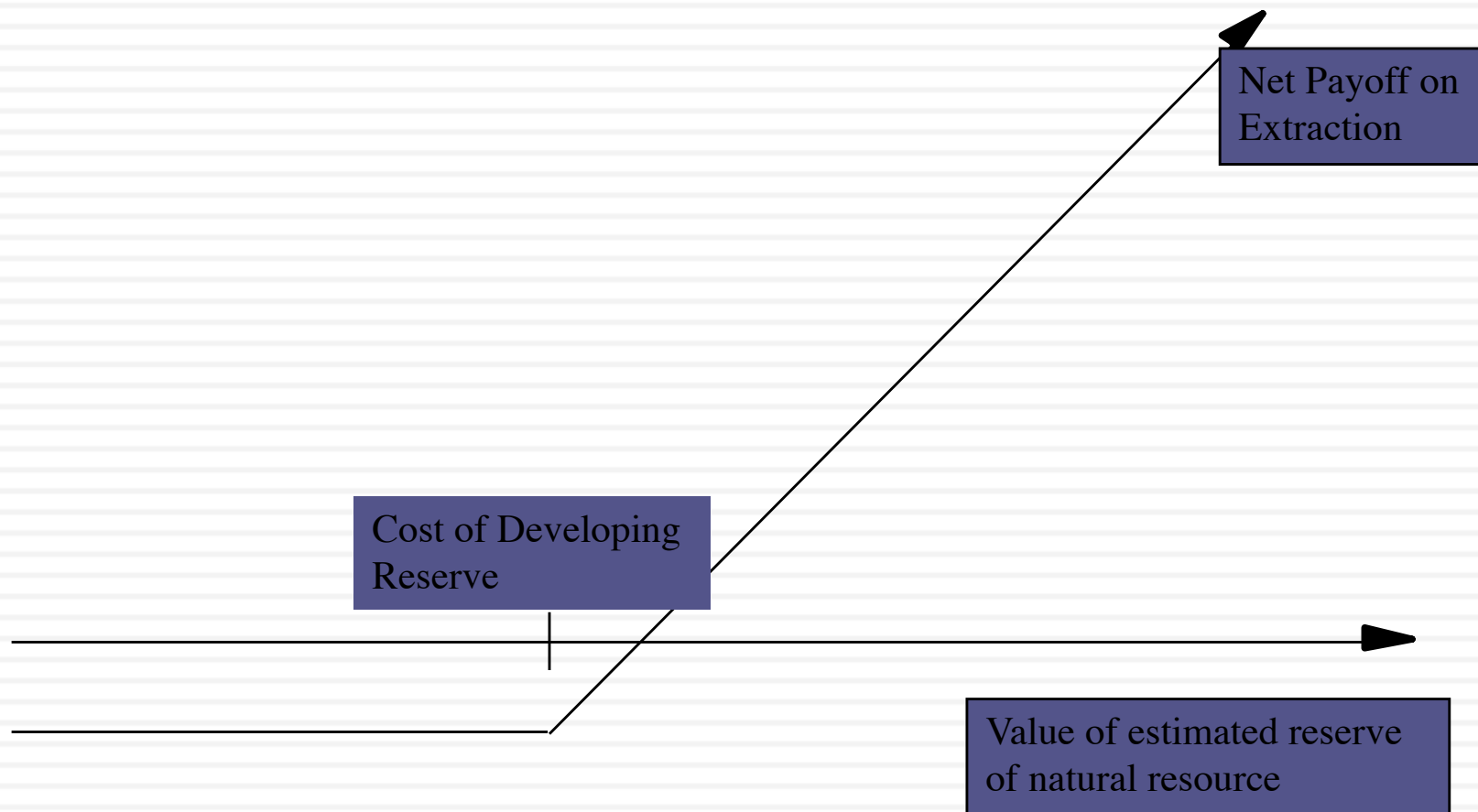

Valuing Gulf Oil

- Gulf Oil was the target of a takeover in early 1984 at \$70 per share (It had 165.30 million shares outstanding, and total debt of \$9.9 billion).
 - It had estimated reserves of 3038 million barrels of oil and the average cost of developing these reserves was estimated to be \$10 a barrel in present value dollars (The development lag is approximately two years).
 - The average relinquishment life of the reserves is 12 years.
 - The price of oil was \$22.38 per barrel, and the production cost, taxes and royalties were estimated at \$7 per barrel.
 - The bond rate at the time of the analysis was 9.00%.
 - Gulf was expected to have net production revenues each year of approximately 5% of the value of the developed reserves. The variance in oil prices is 0.03.

Valuing Undeveloped Reserves

- Inputs for valuing undeveloped reserves
 - ▣ Value of underlying asset = Value of estimated reserves discounted back for period of development lag = $3038 * (\$ 22.38 - \$7) / 1.05^2 = \$42,380.44$
 - ▣ Exercise price = Estimated development cost of reserves = $3038 * \$10 = \$30,380$ million
 - ▣ Time to expiration = Average length of relinquishment option = 12 years
 - ▣ Variance in value of asset = Variance in oil prices = 0.03
 - ▣ Riskless interest rate = 9%
 - ▣ Dividend yield = Net production revenue/ Value of developed reserves = 5%
- Based upon these inputs, the Black-Scholes model provides the following value for the call:
 - ▣ $d1 = 1.6548$ $N(d1) = 0.9510$
 - ▣ $d2 = 1.0548$ $N(d2) = 0.8542$
- Call Value = $42,380.44 \exp^{(-0.05)(12)} (0.9510) - 30,380 (\exp^{(-0.09)(12)} (0.8542)) = \$ 13,306$ million

The composite value...

- In addition, Gulf Oil had free cashflows to the firm from its oil and gas production of \$915 million from already developed reserves and these cashflows are likely to continue for ten years (the remaining lifetime of developed reserves).
- The present value of these developed reserves, discounted at the weighted average cost of capital of 12.5%, yields:
 - ▣ Value of already developed reserves = $915 (1 - 1.125^{-10}) / .125 = \5065.83
- Adding the value of the developed and undeveloped reserves
 - ▣ Value of undeveloped reserves = \$ 13,306 million
 - ▣ Value of production in place = \$ 5,066 million
 - ▣ Total value of firm = \$ 18,372 million
 - ▣ Less Outstanding Debt = \$ 9,900 million
 - ▣ Value of Equity = \$ 8,472 million
 - ▣ Value per share = \$ 8,472/165.3 = \$51.25

VII. Valuing Companies across the ownership cycle

Reported income and balance sheet are heavily affected by tax considerations rather than information disclosure requirements. The line between the personal and business expenses is a fine one.

What are the **cashflows from existing assets**?
- Equity: Cashflows after debt payments
- Firm: Cashflows before debt payments

Reversing investment mistakes is difficult to do. The need for and the cost of illiquidity has to be incorporated into current value.

What is the **value added** by growth assets?
Equity: Growth in equity earnings/ cashflows
Firm: Growth in operating earnings/ cashflows

How **risky are the cash flows** from both existing assets and growth assets?
Equity: Risk in equity in the company
Firm: Risk in the firm's operations

Different buyers can perceive risk differently in the same private business, largely because what they see as risk will be a function of how diversified they are. The fall back positions of using market prices to extract risk measures does not work.

When will the firm become a **mature firm**, and what are the potential roadblocks?

Many private businesses are finite life enterprises, not expected to last into perpetuity

Kristin's Kandy: Valuation in March 2006

Current Cashflow to Firm

EBIT(1-t) :	300
- Nt CpX	100
- Chg WC	40
= FCFF	160
Reinvestment Rate =	46.67%

Reinvestment Rate
46.67%

Expected Growth in EBIT (1-t)
.4667 * .1364 = .0636
6.36%

Return on Capital
13.64%

Stable Growth
g = 4%; Beta = 3.00;
ROC = 12.54%
Reinvestment Rate = 31.90%

Terminal Value₅ = 289 / (.1254 - .04) = 3,403

Firm Value:	2,571
+ Cash	125
- Debt:	900
= Equity	1,796
- Illiq Discount	12.5%
Adj Value	1,571

Year	1	2	3	4	5	Term Yr
EBIT (1-t)	\$319	\$339	\$361	\$384	\$408	425
- Reinvestment	\$149	\$158	\$168	\$179	\$191	136
=FCFF	\$170	\$181	\$193	\$205	\$218	289

Discount at Cost of Capital (WACC) = 16.26% (.70) + 3.30% (.30) = 12.37%

Cost of Equity
16.26%

Cost of Debt
(4.5% + 1.00)(1 - .40)
= 3.30%
Synthetic rating = A-

Weights
E = 70% D = 30%

Riskfree Rate:
Riskfree rate = 4.50%
(10-year T.Bond rate)

Total Beta
2.94

Risk Premium
4.00%

1/3 of risk is market risk

Adjusted for owner non-diversification

Market Beta: 0.98

Mature risk premium
4%

Country Risk Premium
0%

Aswath Damodaran

Unlevered Beta for Sectors: 0.78

Firm's D/E Ratio: 30/70

Lesson 1: In private businesses, risk in the eyes of the “beholder” (buyer)

Private business owner with entire wealth invested in the business

Venture capitalist, with multiple holdings in the sector.

Public company investor with diversified portfolio

Exposed to all risk in the company. Total beta measures exposure to total risk. Total Beta = Market Beta/ Correlation of firm with market

Partially diversified. Diversify away some firm specific risk but not all. Beta will fall between total and market beta.

Firm-specific risk is diversified away. Market or macro risk exposure captured in a market beta or betas.

Private Owner versus Publicly Traded Company Perceptions of Risk in an Investment

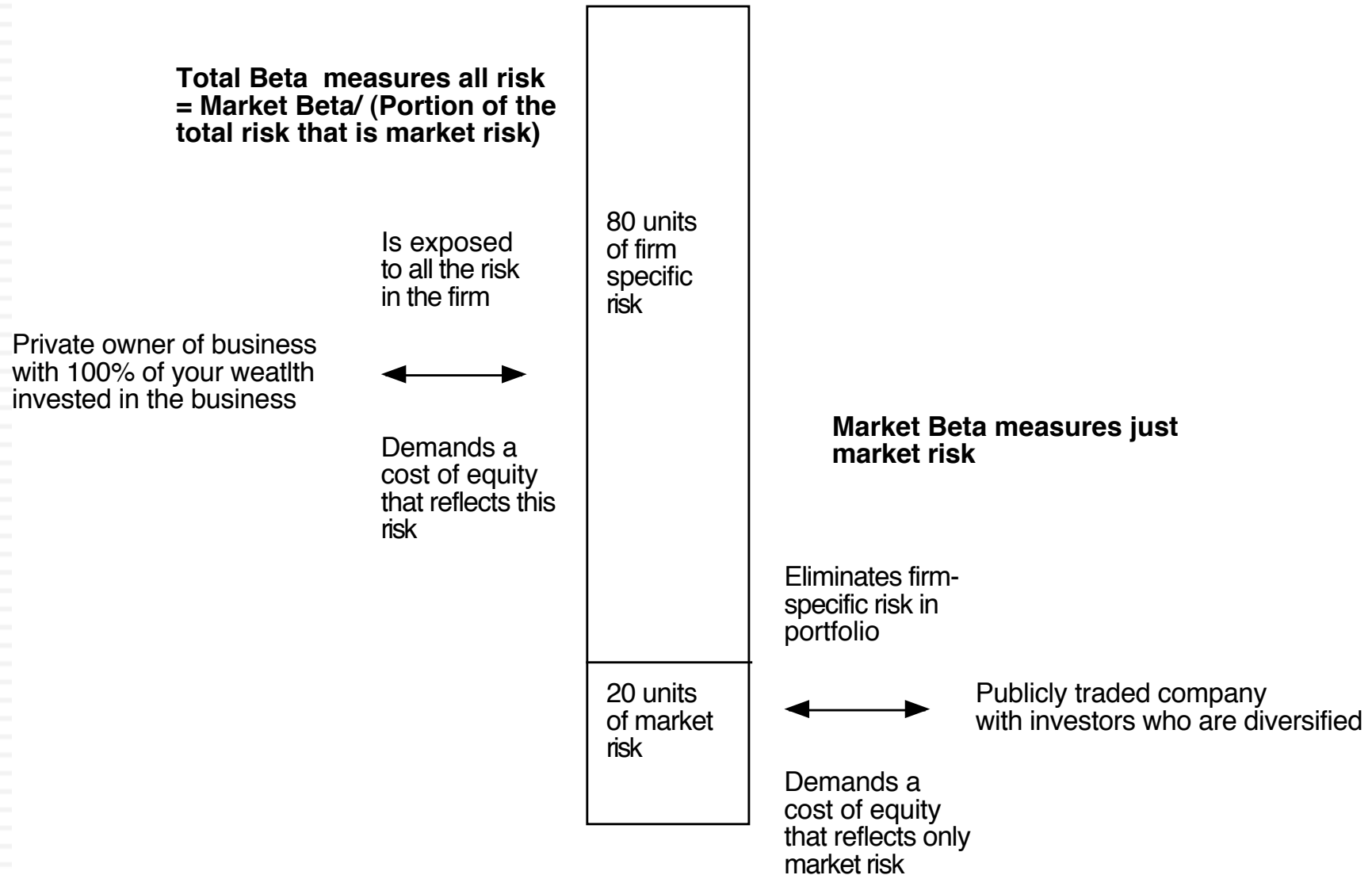

Total Risk versus Market Risk

- Adjust the beta to reflect total risk rather than market risk. This adjustment is a relatively simple one, since the R squared of the regression measures the proportion of the risk that is market risk.
 - Total Beta = Market Beta / Correlation of the sector with the market
- To estimate the beta for Kristin Kandy, we begin with the bottom-up unlevered beta of food processing companies:
 - Unlevered beta for publicly traded food processing companies = 0.78
 - Average correlation of food processing companies with market = 0.333
 - Unlevered total beta for Kristin Kandy = $0.78/0.333 = 2.34$
 - Debt to equity ratio for Kristin Kandy = $0.3/0.7$ (assumed industry average)
 - Total Beta = $2.34 (1 - (1-.40)(30/70)) = 2.94$
 - Total Cost of Equity = $4.50\% + 2.94 (4\%) = 16.26\%$

Lesson 2: With financials, trust but verify..

- Different Accounting Standards: The accounting statements for private firms are often based upon different accounting standards than public firms, which operate under much tighter constraints on what to report and when to report.
- Intermingling of personal and business expenses: In the case of private firms, some personal expenses may be reported as business expenses.
- Separating “Salaries” from “Dividends”: It is difficult to tell where salaries end and dividends begin in a private firm, since they both end up with the owner.
- The Key Person issue: In some private businesses, with a personal component, the cashflows may be intertwined with the owner being part of the business.

Lesson 3: Illiquidity is a clear and present danger..

- In private company valuation, illiquidity is a constant theme. All the talk, though, seems to lead to a rule of thumb. The illiquidity discount for a private firm is between 20-30% and does not vary across private firms.
- But illiquidity should vary across:
 - Companies: Healthier and larger companies, with more liquid assets, should have smaller discounts than money-losing smaller businesses with more illiquid assets.
 - Time: Liquidity is worth more when the economy is doing badly and credit is tough to come by than when markets are booming.
 - Buyers: Liquidity is worth more to buyers who have shorter time horizons and greater cash needs than for longer term investors who don't need the cash and are willing to hold the investment.

And it is not just in private businesses..

- Vinamilk is a publicly traded company, but in a market with light and sporadic liquidity. Will the lack of liquidity affect your valuation of Vietnamese companies?
 - a. Yes
 - b. No
- If yes, where, in your valuation, would you reflect it? If not, why not?



NARRATIVE AND NUMBERS:
VALUATION AS A BRIDGE



Valuation as a bridge

Number Crunchers

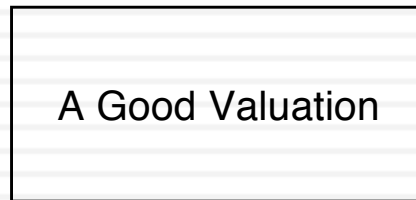
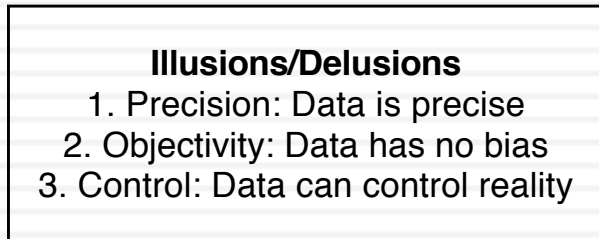
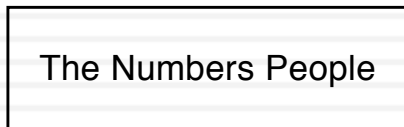
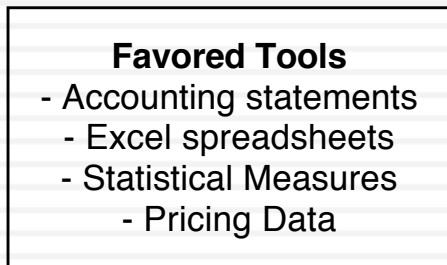

Story Tellers

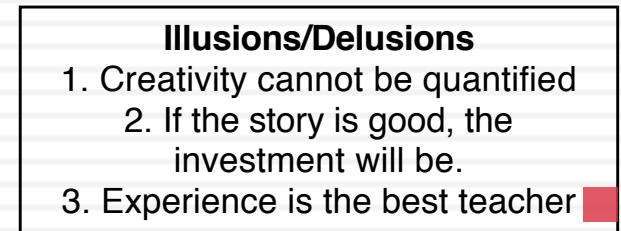
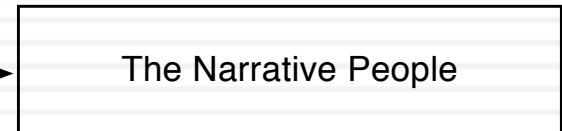
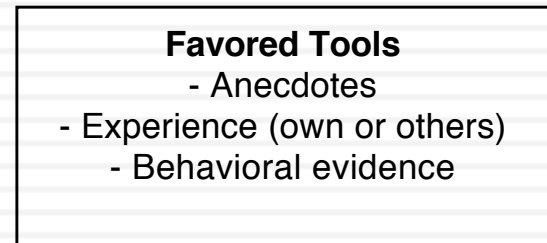

Step 1: Survey the landscape

- Every valuation starts with a narrative, a story that you see unfolding for your company in the future.
- In developing this narrative, you will be making assessments of
 - ▣ Your company (its products, its management and its history).
 - ▣ The market or markets that you see it growing in.
 - ▣ The competition it faces and will face.
 - ▣ The macro environment in which it operates.

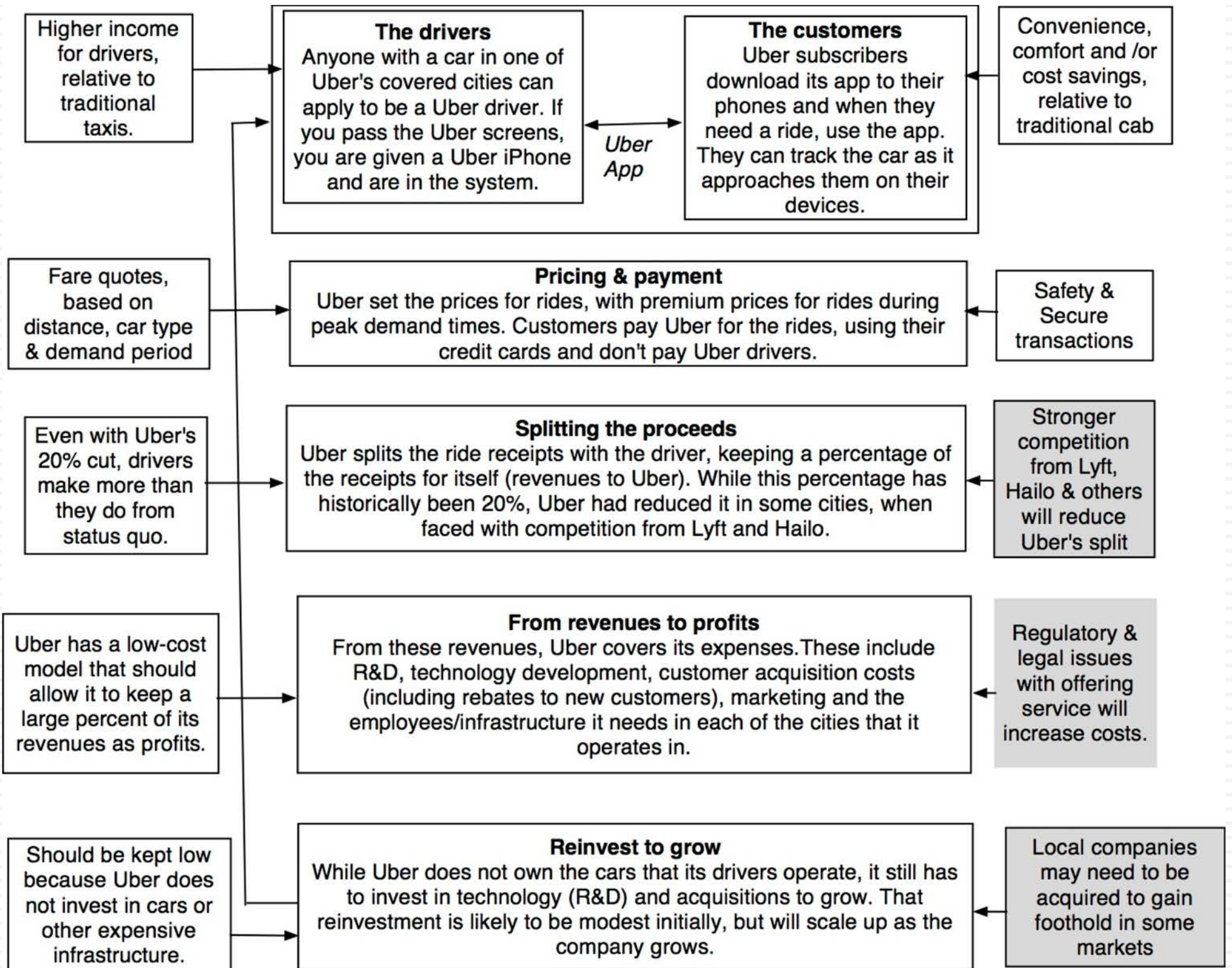

Low Growth

The Auto Business

Low Margins

Year ▼	Revenues (\$) ▼	% Growth Rate ▼
2005	1,274,716.60	
2006	1,421,804.20	11.54%
2007	1,854,576.40	30.44%
2008	1,818,533.00	-1.94%
2009	1,572,890.10	-13.51%
2010	1,816,269.40	15.47%
2011	1,962,630.40	8.06%
2012	2,110,572.20	7.54%
2013	2,158,603.00	2.28%
2014	2,086,124.80	-3.36%
ounded Average =		5.63%

+

The Automobile Business: Pre-tax Operating Margins in 2015

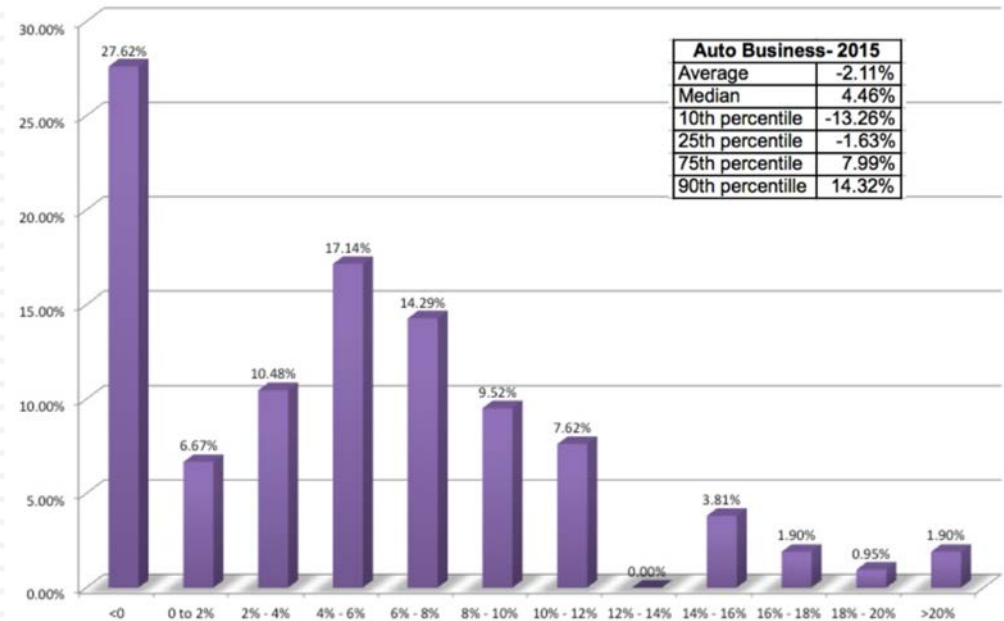

Auto Business-2015	
Average	-2.11%
Median	4.46%
10th percentile	-13.26%
25th percentile	-1.63%
75th percentile	7.99%
90th percentile	14.32%

High & Increasing Reinvestment

Bad Business

The Reinvestment Burden: Investment as % of Sales for Auto Business

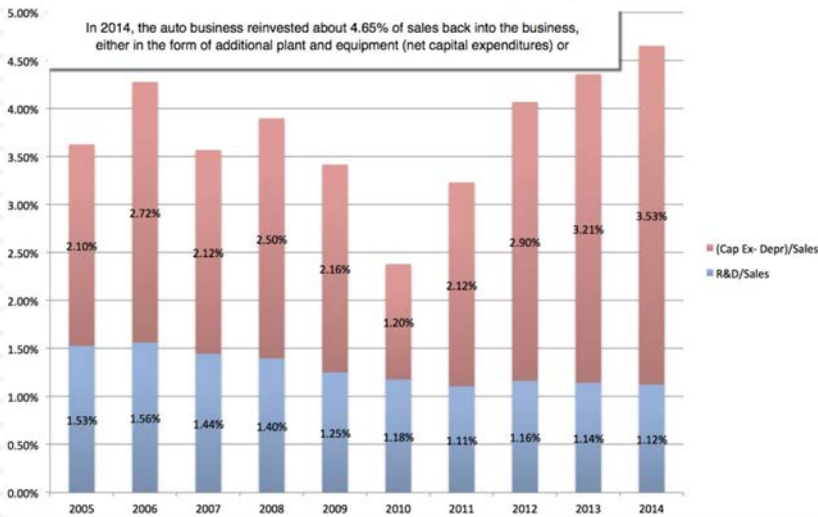

=

	ROIC	Cost of capital	ROIC - Cost of capital
2004	6.82%	7.93%	-1.11%
2005	10.47%	7.02%	3.45%
2006	4.60%	7.97%	-3.37%
2007	7.62%	8.50%	-0.88%
2008	3.48%	8.03%	-4.55%
2009	-4.97%	8.58%	-13.55%
2010	5.16%	8.03%	-2.87%
2011	7.55%	8.15%	-0.60%
2012	7.80%	8.55%	-0.75%
2013	7.83%	8.47%	-0.64%
2014	6.47%	7.53%	-1.06%

Only once in the last 10 years have auto companies collectively earned more than their cost of capital

What makes Ferrari different?

Ferrari sold only 7,255 cars in all of 2014

Ferrari had a profit margin of 18.2%, in the 95th percentile, partly because of its high prices and partly because it spends little on advertising.

Ferrari: Geographical Sales (2014)

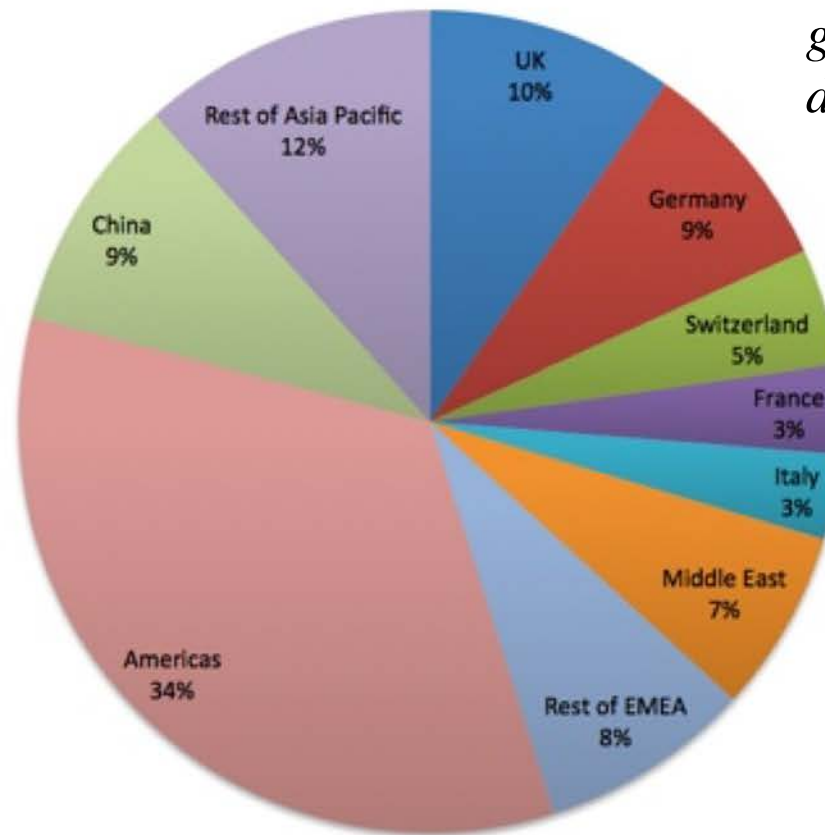

Ferrari sales (in units) have grown very little in the last decade & have been stable

Ferrari has not invested in new plants.

Step 2: Create a narrative for the future

- Every valuation starts with a narrative, a story that you see unfolding for your company in the future.
- In developing this narrative, you will be making assessments of your company (its products, its management), the market or markets that you see it growing in, the competition it faces and will face and the macro environment in which it operates.
 - ▣ Rule 1: Keep it simple.
 - ▣ Rule 2: Keep it focused.

The Uber Narrative

In June 2014, my initial narrative for Uber was that it would be

1. An urban car service business: I saw Uber primarily as a force in urban areas and only in the car service business.
2. Which would expand the business moderately (about 40% over ten years) by bringing in new users.
3. With local networking benefits: If Uber becomes large enough in any city, it will quickly become larger, but that will be of little help when it enters a new city.
4. Maintain its revenue sharing (20%) system due to strong competitive advantages (from being a first mover).
5. And its existing low-capital business model, with drivers as contractors and very little investment in infrastructure.

The Ferrari Narrative

- Ferrari will stay an exclusive auto club, deriving its allure from its scarcity and the fact that only a few own Ferraris.
- By staying exclusive, the company gets three benefits:
 - It can continue to charge nose bleed prices for its cars and sell them with little or no advertising.
 - It does not need to invest in new assembly plants, since it does not plan to ramp up production.
 - It sells only to the super rich, who are unaffected by overall economic conditions or market crises.

Step 3: Check the narrative against history, economic first principles & common sense

150

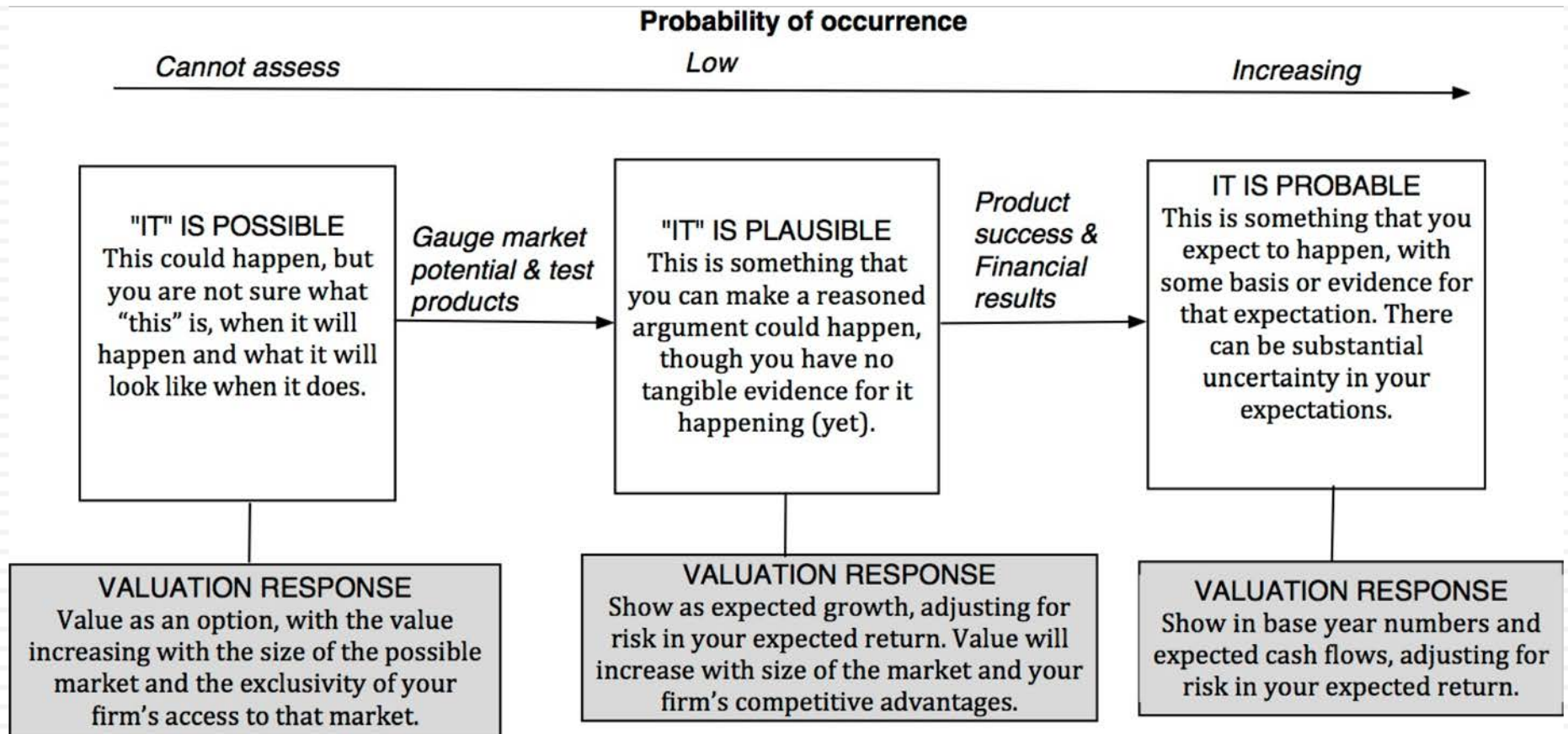

The Impossible, The Implausible and the Improbable

151

The Impossible

Bigger than the economy

Assuming Growth rate for company in perpetuity > Growth rate for economy

Bigger than the total market

Allowing a company's revenues to grow so much that it has more than a 100% market share of whatever business it is in.

Profit margin > 100%

Assuming earnings growth will exceed revenue growth for a long enough period, and pushing margins above 100%

Depreciation without cap ex

Assuming that depreciation will exceed cap ex in perpetuity.

The Implausible

Growth without reinvestment

Assuming growth forever without reinvestment.

Profits without competition

Assuming that your company will grow and earn higher profits, with no competition.

Returns without risk

Assuming that you can generate high returns in a business with no risk.

The Improbable

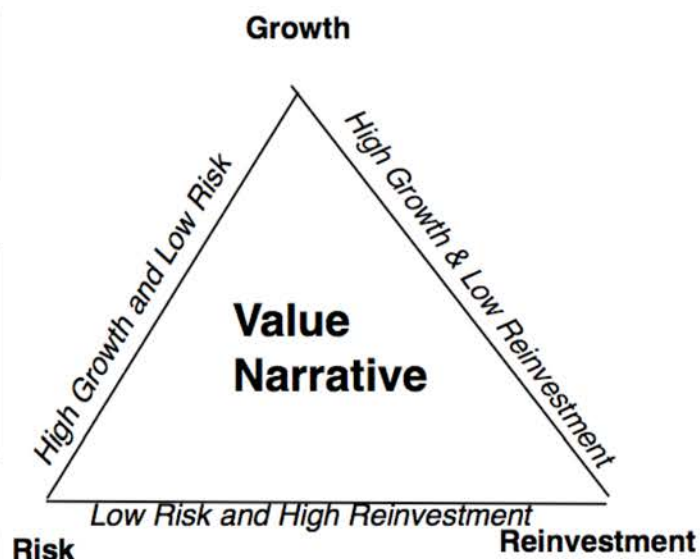

Uber: Possible, Plausible and Probable

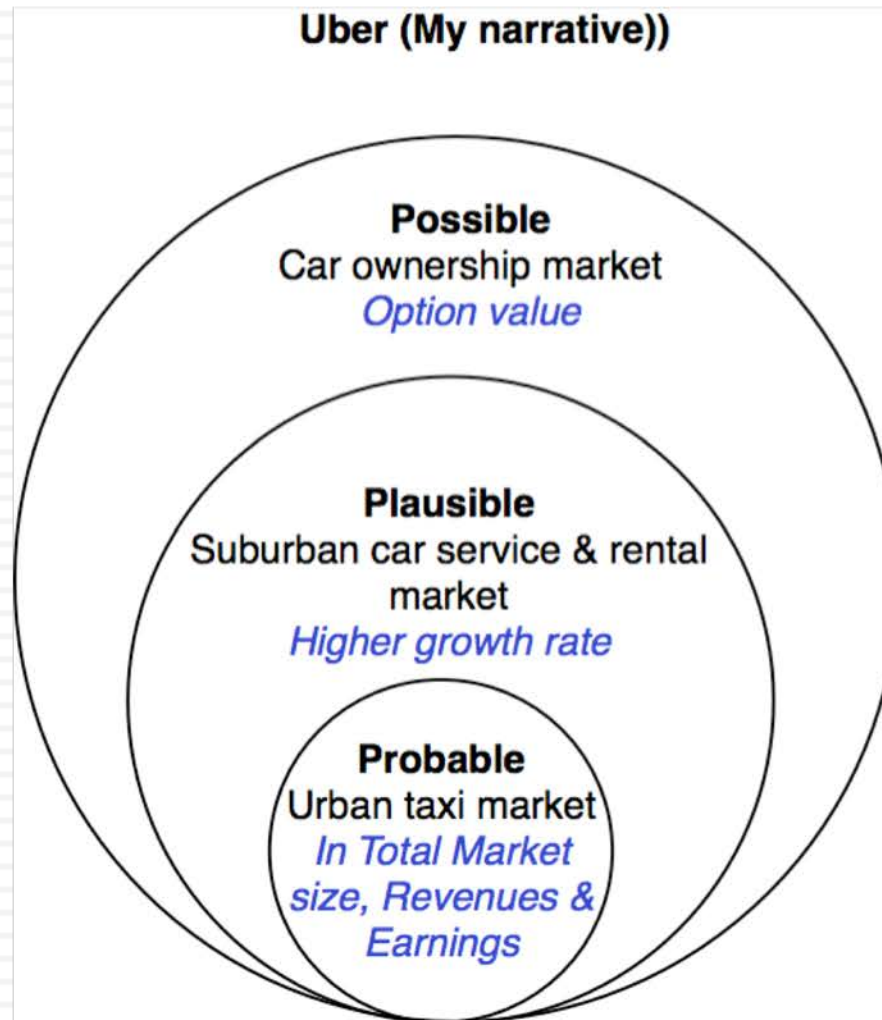

Step 4: Connect your narrative to key drivers of value

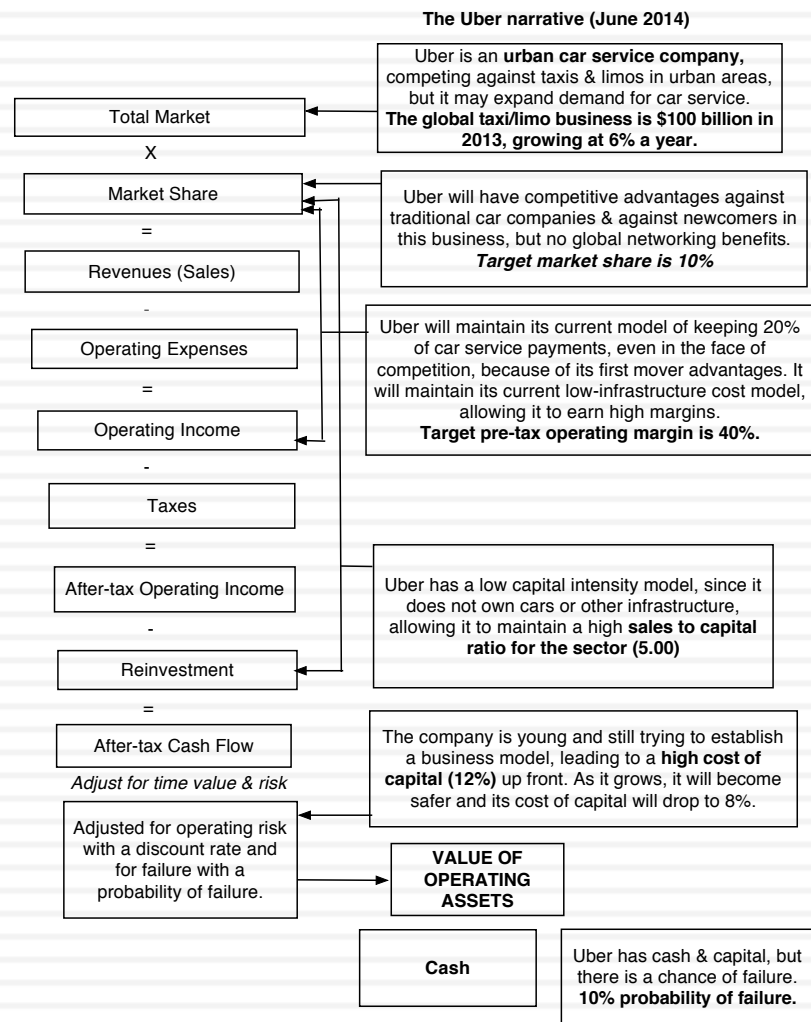

Ferrari: From story to numbers

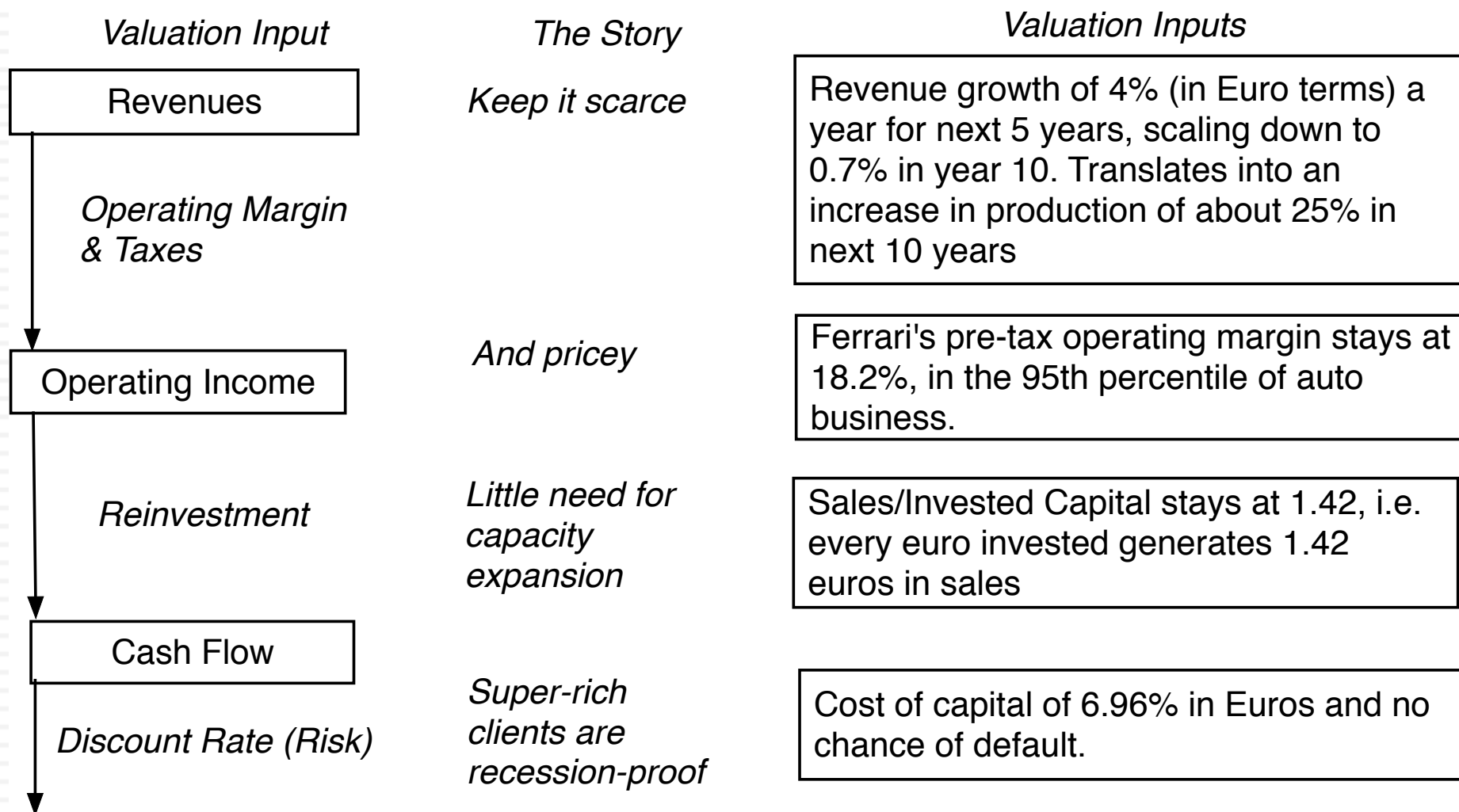

Step 5: Value the company (Uber)

155

Uber: Intrinsic valuation - June 8, 2014 (in US \$)

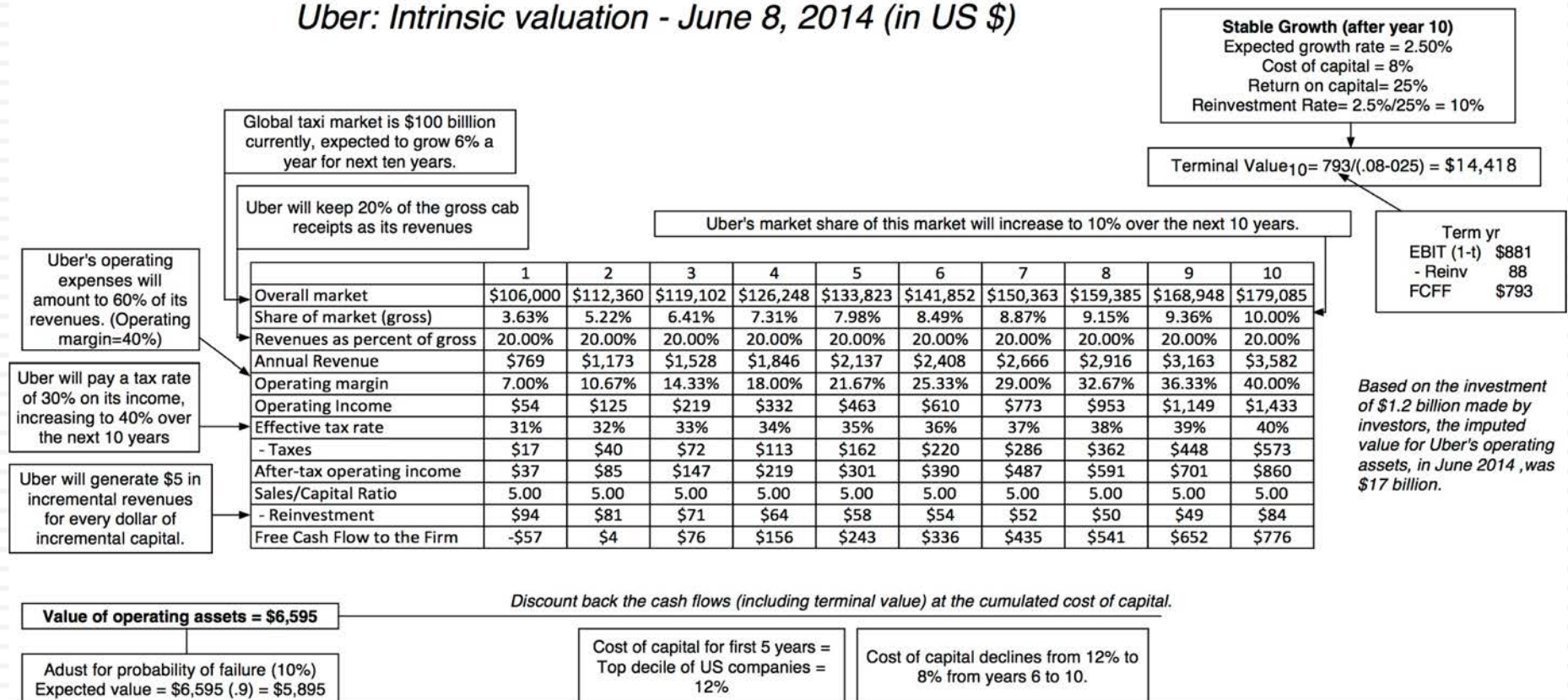

Ferrari: The “Exclusive Club” Value

Stay Super Exclusive: Revenue growth is low

	Base year	1	2	3	4	5	6	7	8	9	10	Terminal year
Revenue growth rate		4.00%	4.00%	4.00%	4.00%	4.00%	3.34%	2.68%	2.02%	1.36%	0.70%	0.70%
Revenues	€ 2,763	€ 2,874	€ 2,988	€ 3,108	€ 3,232	€ 3,362	€ 3,474	€ 3,567	€ 3,639	€ 3,689	€ 3,714	€ 3,740
EBIT (Operating) margin	18.20%	18.20%	18.20%	18.20%	18.20%	18.20%	18.20%	18.20%	18.20%	18.20%	18.20%	18.20%
EBIT (Operating income)	€ 503	€ 523	€ 544	€ 566	€ 588	€ 612	€ 632	€ 649	€ 662	€ 671	€ 676	€ 681
Tax rate	33.54%	33.54%	33.54%	33.54%	33.54%	33.54%	33.54%	33.54%	33.54%	33.54%	33.54%	33.54%
EBIT(1-t)	€ 334	€ 348	€ 361	€ 376	€ 391	€ 407	€ 420	€ 431	€ 440	€ 446	€ 449	€ 452
- Reinvestment		€ 78	€ 81	€ 84	€ 87	€ 91	€ 79	€ 66	€ 51	€ 35	€ 18	€ 22
FCFF		€ 270	€ 281	€ 292	€ 303	€ 316	€ 341	€ 366	€ 389	€ 411	€ 431	€ 431
Cost of capital		6.96%	6.96%	6.96%	6.96%	6.96%	6.96%	6.97%	6.98%	6.99%	7.00%	7.00%
PV(FCFF)		€ 252	€ 245	€ 238	€ 232	€ 225	€ 228	€ 228	€ 227	€ 224	€ 220	
Terminal value	€ 6,835											
PV(Terminal value)	€ 3,485											
PV (CF over next 10 years)	€ 2,321											
Value of operating assets =	€ 5,806											
- Debt	€ 623											
- Minority interests	€ 13											
+ Cash	€ 1,141											
Value of equity	€ 6,311											

High Prices
+ No selling
cost =
Preserve
current
operating
margin

Minimal
Reinvestment
due to low
growth

The super
rich are not
sensitive to
economic
downturns

Step 5: Keep the feedback loop

157

1. Not just car service company.: Uber is a car company, not just a car service company, and there may be a day when consumers will subscribe to a Uber service, rather than own their own cars. It could also expand into logistics, i.e., moving and transportation businesses.
2. Not just urban: Uber can create new demands for car service in parts of the country where taxis are not used (suburbia, small towns).
3. Global networking benefits: By linking with technology and credit card companies, Uber can have global networking benefits.

Valuing Bill Gurley's Uber narrative

	<i>Uber (Gurley)</i>	<i>Uber (Gurley Mod)</i>	<i>Uber (Damodaran)</i>
Narrative	Uber will <u>expand the car service market substantially</u> , bringing in mass transit users & non-users from the suburbs into the market, and use its <u>networking advantage to gain a dominant market share</u> , while maintaining its revenue slice at 20%.	Uber will <u>expand the car service market substantially</u> , bringing in mass transit users & non-users from the suburbs into the market, and use its <u>networking advantage to gain a dominant market share</u> , while cutting prices and margins (to 10%).	Uber will expand the car service market moderately, primarily in urban environments, and use its <u>competitive advantages to get a significant but not dominant market share</u> and maintain its revenue slice at 20%.
Total Market	\$300 billion, growing at 3% a year	\$300 billion, growing at 3% a year	\$100 billion, growing at 6% a year
Market Share	40%	40%	10%
Uber's revenue slice	20%	10%	20%
Value for Uber	\$53.4 billion + Option value of entering car ownership market (\$10 billion+)	\$28.7 billion + Option value of entering car ownership market (\$6 billion+)	\$5.9 billion + Option value of entering car ownership market (\$2-3 billion)

Different narratives, Different Numbers

<i>Total Market</i>	<i>Growth Effect</i>	<i>Network Effect</i>	<i>Competitive Advantages</i>	<i>Value of Uber</i>
A4. Mobility Services	B4. Double market size	C5. Strong global network effects	D4. Strong & Sustainable	\$90,457
A3. Logistics	B4. Double market size	C5. Strong global network effects	D4. Strong & Sustainable	\$65,158
A4. Mobility Services	B3. Increase market by 50%	C3. Strong local network effects	D3. Semi-strong	\$52,346
A2. All car service	B4. Double market size	C5. Strong global network effects	D4. Strong & Sustainable	\$47,764
A1. Urban car service	B4. Double market size	C5. Strong global network effects	D4. Strong & Sustainable	\$31,952
A3. Logistics	B3. Increase market by 50%	C3. Strong local network effects	D3. Semi-strong	\$14,321
A1. Urban car service	B3. Increase market by 50%	C3. Strong local network effects	D3. Semi-strong	\$7,127
A2. All car service	B3. Increase market by 50%	C3. Strong local network effects	D3. Semi-strong	\$4,764
A4. Mobility Services	B1. None	C1. No network effects	D1. None	\$1,888
A3. Logistics	B1. None	C1. No network effects	D1. None	\$1,417
A2. All car service	B1. None	C1. No network effects	D1. None	\$1,094
A1. Urban car service	B1. None	C1. No network effects	D1. None	\$799

The Ferrari Counter Narrative

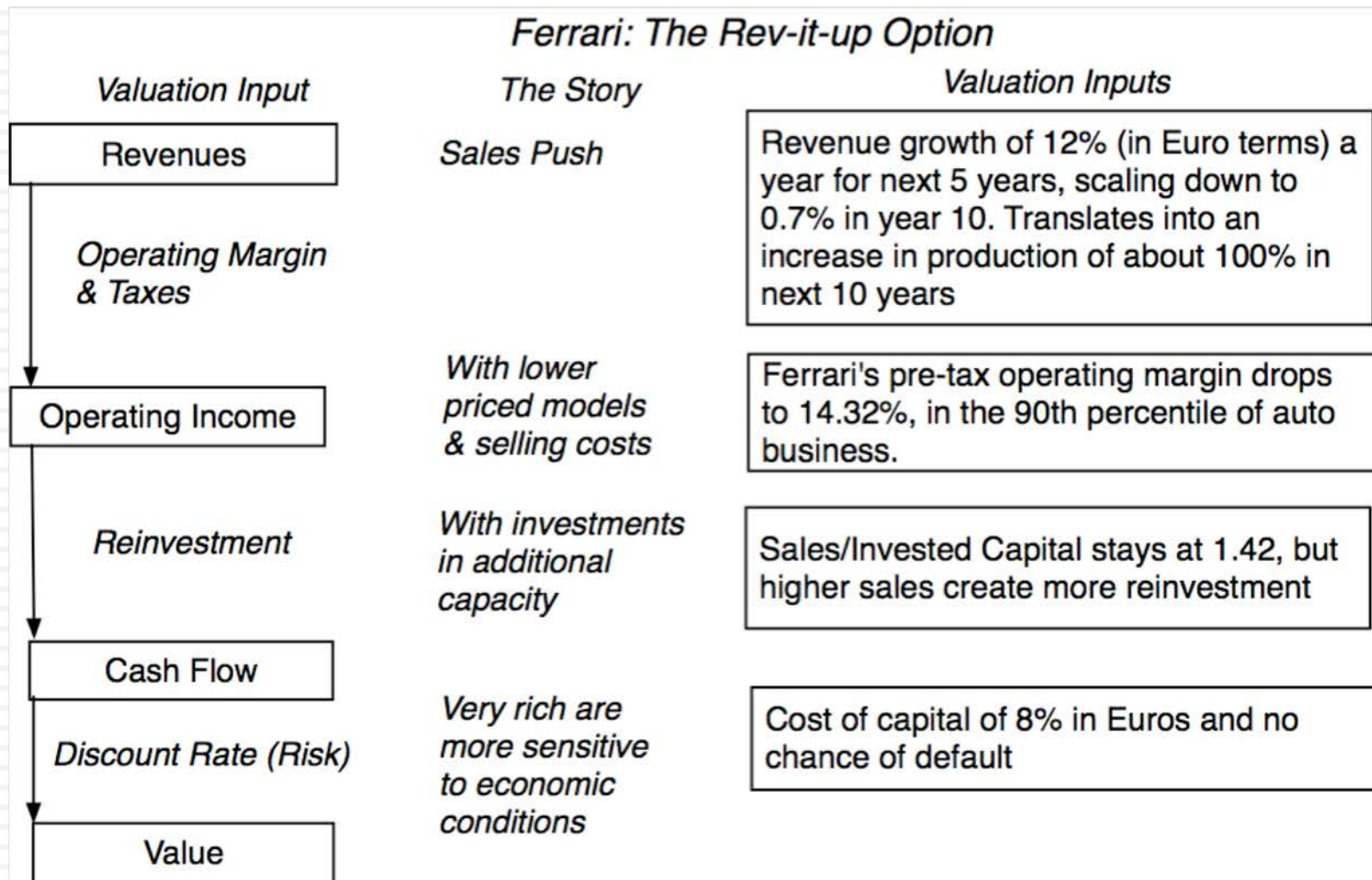

Ferrari: The “Rev-it-up” Alternative

Get less exclusive: Double number of cars sold over next decade

	Base year	1	2	3	4	5	6	7	8	9	10	Terminal year
Revenue growth rate		12.00%	12.00%	12.00%	12.00%	12.00%	9.74%	7.48%	5.22%	2.96%	0.70%	0.70%
Revenues	€ 2,763	€ 3,095	€ 3,466	€ 3,882	€ 4,348	€ 4,869	€ 5,344	€ 5,743	€ 6,043	€ 6,222	€ 6,266	€ 6,309
EBIT (Operating) margin	18.20%	17.81%	17.42%	17.04%	16.65%	16.26%	15.87%	15.48%	15.10%	14.71%	14.32%	14.32%
EBIT (Operating income)	€ 503	€ 551	€ 604	€ 661	€ 724	€ 792	€ 848	€ 889	€ 912	€ 915	€ 897	€ 904
Tax rate	33.54%	33.54%	33.54%	33.54%	33.54%	33.54%	33.54%	33.54%	33.54%	33.54%	33.54%	33.54%
EBIT(1-t)	€ 334	€ 366	€ 401	€ 439	€ 481	€ 526	€ 564	€ 591	€ 606	€ 608	€ 596	€ 600
- Reinvestment		€ 233	€ 261	€ 293	€ 328	€ 367	€ 334	€ 281	€ 211	€ 126	€ 31	€ 35
FCFF		€ 133	€ 140	€ 147	€ 153	€ 159	€ 230	€ 310	€ 395	€ 482	€ 566	€ 565
Cost of capital		8.00%	8.00%	8.00%	8.00%	8.00%	7.90%	7.80%	7.70%	7.60%	7.50%	7.50%
PV(FCFF)		€ 123	€ 120	€ 117	€ 113	€ 108	€ 145	€ 181	€ 215	€ 244	€ 266	
Terminal value	€ 8,315											
PV(Terminal value)	€ 3,906											
PV (CF over next 10 years)	€ 1,631											
Value of operating assets =	€ 5,537											
- Debt	€ 623											
- Minority interests	€ 13											
+ Cash	€ 1,141											
Value of equity	€ 6,042											

Lower Prices +
Some selling
cost = Lower
operating
margin

Reinvestment
reflects
higher sales

The very
rich are
more
sensitive to
economic
conditions

And the world is full of feedback.. My Ferrari afterthought!



Step 6: Be ready to modify narrative as events unfold

163

Narrative Break/End	Narrative Shift	Narrative Change (Expansion or Contraction)
Events, external (legal, political or economic) or internal (management, competitive, default), that can cause the narrative to break or end.	Improvement or deterioration in initial business model, changing market size, market share and/or profitability.	Unexpected entry/success in a new market or unexpected exit/failure in an existing market.
Your valuation estimates (cash flows, risk, growth & value) are no longer operative	Your valuation estimates will have to be modified to reflect the new data about the company.	Valuation estimates have to be redone with new overall market potential and characteristics.
Estimate a probability that it will occur & consequences	Monte Carlo simulations or scenario analysis	Real Options

Uber: The September 2015 Update

<i>Input</i>	<i>June 2014</i>	<i>September 2015</i>	<i>Rationale</i>
Total Market	\$100 billion; Urban car service	\$230 billion; Logistics	Market is broader, bigger & more global than I thought it would be. <u>Uber's</u> entry into delivery & moving businesses is now plausible, perhaps even probable.
Growth in market	Increase market size by 34%; CAGR of 6%.	Double market size; CAGR of 10.39%.	New customers being drawn to car sharing, with more diverse offerings.
Market Share	10% (Local Networking)	25% (Weak Global Networking)	Higher cost of entry will reduce competitors, but remaining competitors have access to capital & in Asia, the hometown advantage.
Slice of gross receipts	20% (Left at status quo)	15%	Increased competition will reduce car service company slice.
Operating margin	40% (Low cost model)	25% (Partial employee model)	Drivers will become partial employees, higher insurance and regulatory costs.
Cost of capital	12% (Ninth decile of US companies)	10% (75 th percentile of US companies)	Business model in place and substantial revenues.
Probability of failure	10%	0%	Enough cash on hand to find off threats to survival.
Value of equity	\$5.9 billion	\$23.4 billion	Value increased more than four fold.

Potential Market	Market size (in millions)
A1. Urban car service	\$100,000
A2. All car service	\$175,000
A3. Logistics	\$230,000
A4. Mobility Services	\$310,000

Growth Effect	CAGR (next 10 years)
B1. None	3.00%
B2. Increase market by 25%	5.32%
B3. Increase market size by 50%	7.26%
B4: Double market size	10.39%

Network Effects	Market Share
C1. No network effects	5%
C2. Weak local network effects	10%
C3. Strong local network effects	15%
C4. Weak global network effects	25%
C5. Strong global network effects	40%

Increases overall market to \$618 billion in year 10

	Base	2016	2017	2018	2019	2020	2021	2022	2023	2024	2025	Assumptions
Overall market	\$230,000	\$253,897	\$280,277	\$309,398	\$341,544	\$377,031	\$416,204	\$459,448	\$507,184	\$559,881	\$618,052	A3 & B4
Share of market (gross)	4.71%	6.74%	8.77%	10.80%	12.83%	14.86%	16.89%	18.91%	20.94%	22.97%	25.00%	C4
Gross Billings	\$10,840	\$17,117	\$24,582	\$33,412	\$43,813	\$56,014	\$70,277	\$86,900	\$106,218	\$128,612	\$154,513	
Revenues as percent of gross	20.00%	19.50%	19.00%	18.50%	18.00%	17.50%	17.00%	16.50%	16.00%	15.50%	15.00%	D3
Annual Revenue	\$2,168	\$3,338	\$4,670	\$6,181	\$7,886	\$9,802	\$11,947	\$14,338	\$16,995	\$19,935	\$23,177	
Operating margin	-23.06%	-18.26%	-13.45%	-8.64%	-3.84%	0.97%	5.77%	10.58%	15.39%	20.19%	25.00%	E2
Operating Income	-\$500	-\$609	-\$628	-\$534	-\$303	\$95	\$690	\$1,517	\$2,615	\$4,026	\$5,794	
Effective tax rate	30.00%	31.00%	32.00%	33.00%	34.00%	35.00%	36.00%	37.00%	38.00%	39.00%	40.00%	
- Taxes	-\$150	-\$189	-\$201	-\$176	-\$103	\$33	\$248	\$561	\$994	\$1,570	\$2,318	
After-tax operating income	-\$350	-\$420	-\$427	-\$358	-\$200	\$62	\$442	\$956	\$1,621	\$2,456	\$3,477	
Sales/Capital Ratio		5.00	5.00	5.00	5.00	5.00	5.00	5.00	5.00	5.00	5.00	F
- Reinvestment		\$234	\$267	\$302	\$341	\$383	\$429	\$478	\$531	\$588	\$648	
Free Cash Flow to the Firm		-\$654	-\$694	-\$660	-\$541	-\$322	\$13	\$478	\$1,090	\$1,868	\$2,828	
Terminal value											\$56,258	
Present value of FCFF		-\$595	-\$573	-\$496	-\$369	-\$200	\$7	\$248	\$520	\$822	\$1,152	
Present value of terminal value											\$22,914	
Cost of capital	10.00%	10.00%	10.00%	10.00%	10.00%	10.00%	9.60%	9.20%	8.80%	8.40%	8.00%	G1

PV of cash flows during next 10 years =	\$515	
PV of terminal value =	\$22,914	
Value of operating assets	\$23,429	
Probability of failure	0.00%	G2
Adjusted value of operating assets	\$23,429	
Less Debt	\$0	
Value of Equity	\$23,429	

Expense Profile	Operating Margin
E1: Independent contractor	40%
E2: Partial employee	25%
E3: Full employee	15%

Capital Intensity
F: Status Quo: Sales/Capital = 5

Competitive Advantages	Slice of Gross Receipts
D1. None	5%
D2. Weak	10%
D3. Semi-strong	15%
D4. Strong & Sustainable	20%

Risk Estimates

- G1. Cost of capital at 75th percentile of US companies = 10%
- G2. Probability of failure in next 10 years= 0%

Uber Valuation: September 2015

A	B	C	D	E	F	G
Vinamilk						
The Story						
Vinamik has had an impressive run of growth with profitability, and it will continue to grow, although at lower rates, while seeing operating margins and reinvestment levels stabilize. It will earn stratospheric excess returns for the next decade, but it is in a business where barriers to entry are not permanent and excess returns will dissipate eventually.						
The Assumptions						
	<i>Base year</i>	<i>Years 1-5</i>	<i>Years 6-10</i>		<i>After year 10</i>	<i>Link to story</i>
Revenues (a)	\$ 51,041	12.00% → 3.05%	3.05%		3.05%	Growth slows as company scales up
Operating margin (b)	22.43%	22.43% → 22.00%	22.00%		22.00%	Profit margins stay high
Tax rate	16.00%	16.00% → 20.00%	20.00%		20.00%	Tax rate moves towards Vietnam marginal
Reinvestment (c)		Sales to capital ratio 3.94		RIR =	38.13%	Reinvestment at same rate as past
Return on capital	72.98%	Marginal ROIC =	85.54%		8.00%	Competitive advantages stay intact for next decade, but eventually disappear.
Cost of capital (d)		8.44% → 8.00%	8.00%		8.00%	Cost of capital moves down mildly
The Cash Flows						
	<i>Revenues</i>	<i>Operating Margin</i>	<i>EBIT</i>	<i>EBIT (1-t)</i>	<i>Reinvestment</i>	<i>FCFF</i>
1	57,166 đ	22.39%	12,800.04 đ	10,752.03 đ	1,553.40 đ	9,198.63 đ
2	64,026 đ	22.35%	14,308.22 đ	12,018.91 đ	1,739.81 đ	10,279.10 đ
3	71,709 đ	22.30%	15,994.05 đ	13,435.01 đ	1,948.58 đ	11,486.42 đ
4	80,314 đ	22.26%	17,878.45 đ	15,017.89 đ	2,182.42 đ	12,835.48 đ
5	89,952 đ	22.22%	19,984.78 đ	16,787.21 đ	2,444.30 đ	14,342.91 đ
6	99,136 đ	22.17%	21,982.15 đ	18,289.15 đ	2,329.26 đ	15,959.89 đ
7	107,483 đ	22.13%	23,786.35 đ	19,599.95 đ	2,117.02 đ	17,482.93 đ
8	114,609 đ	22.09%	25,313.59 đ	20,655.89 đ	1,807.32 đ	18,848.57 đ
9	120,156 đ	22.04%	26,486.56 đ	21,401.14 đ	1,406.85 đ	19,994.30 đ
10	123,821 đ	22.00%	27,240.61 đ	21,792.49 đ	929.46 đ	20,863.03 đ
Terminal year	127,597 đ	22.00%	28,071.45 đ	22,457.16 đ	8,561.79 đ	13,895.37 đ
The Value						
Terminal value			280,714 đ			
PV(Terminal value)			126,380 đ			
PV (CF over next 10 years)			93,863 đ			
Value of operating assets =			220,242 đ			
Adjustment for distress			0 đ		Probability of failure = 0.00%	
- Debt & Minority Interests			1,277 đ			
+ Cash & Other Non-operating assets			12,026 đ			
Value of equity			230,992 đ			
- Value of equity options			0 đ			
Number of shares			1.45			
Value per share			159,161.91 đ		Stock was trading at = 185,000.00 đ	

Aswath Damodaran



RELATIVE VALUATION (PRICING)

Aswath Damodaran

Relative valuation is pervasive...

- Most asset valuations are relative.
- Most equity valuations on Wall Street are relative valuations.
 - Almost 85% of equity research reports are based upon a multiple and comparables.
 - More than 50% of all acquisition valuations are based upon multiples
 - Rules of thumb based on multiples are not only common but are often the basis for final valuation judgments.
- While there are more discounted cashflow valuations in consulting and corporate finance, they are often relative valuations masquerading as discounted cash flow valuations.
 - The objective in many discounted cashflow valuations is to back into a number that has been obtained by using a multiple.
 - The terminal value in a significant number of discounted cashflow valuations is estimated using a multiple.

The Reasons for the allure...

- “If you think I’ m crazy, you should see the guy who lives across the hall”

Jerry Seinfeld talking about Kramer in a Seinfeld episode

- “ A little inaccuracy sometimes saves tons of explanation”

H.H. Munro

- “ If you are going to screw up, make sure that you have lots of company”

Ex-portfolio manager

Pricing versus Valuation

170

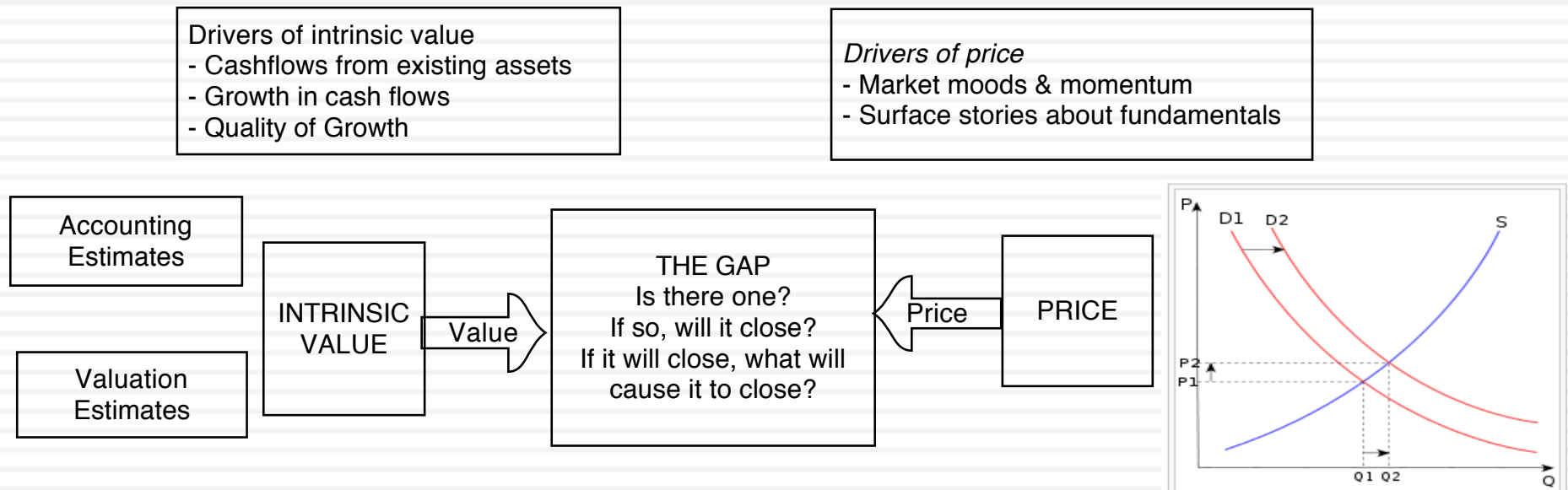

Test 1: Are you pricing or valuing?

171

 **5369 La Jolla Mesa Dr**
La Jolla, CA 92037
Status: Active





\$995,000
Price

3
Beds

2.5
Baths

1,440 Sq. Ft.
\$691 / Sq. Ft.

Built: 1955 Lot Size: 3,000 Sq. Ft. On Redfin: 12 days

Favorite X-Out Share... Tour Home

Overview Property Details Tour Insights Property History Public Records Activity Schools Neighborhood & Offer Insights Similar Homes



1 of 25  [Play Video](#)

Lisa Padilla
REDFIN Real Estate Agent

★★★★★
47 client reviews

\$8,726 commission refund

 [Go Tour This Home](#)

[Ask Lisa a Question](#) or [Start an Offer](#)

1 of 4 Redfin Agents in this area

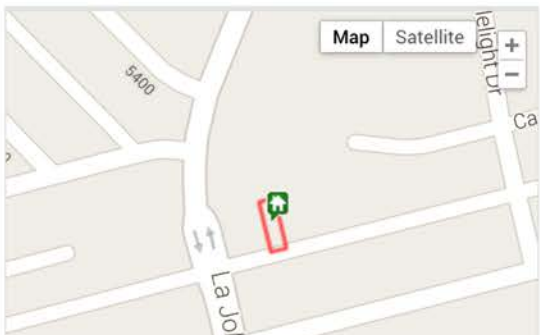

Test 2: Are you pricing or valuing?

172

Europe
Switzerland

Biotechnology
Biotechnology

Reuters
BION.S

Bloomberg
BION SW

Exchange
SWX
Ticker
BION

Price at 12 Aug 2013 (CHF)	124.00
Price Target (CHF)	164.50
52-week range (CHF)	128.40 - 84.90

Strong sector and stock-picking continue

Impressive performance

Over the past two years, BB Biotech shares have roughly tripled, which could tempt investors to take profits. However, this performance has been well backed by a deserved revival of the biotech industry, encouraging fundamental news, M&A, and increased money flow into health care stocks. In addition, BBB returned to index outperformance by modifying its stock-picking approach. Hence, despite excellent performance, the shares still trade at a 23% discount to the net asset value of the portfolio. Hence, the shares are an attractive value vehicle to capture growth opportunities in an attractive sector.

Biotech industry remains attractive

With the re-rating of the pharma sector, investors have also showed increased interest in biotech stocks. Established biotech stocks have delivered encouraging financial results and approvals, while there has also been substantial industry consolidation, which is not surprising in times of "cheap" money and high liquidity. BB Biotech remains an attractive vehicle to capture the future potential of the biotech sector. In addition, investors benefit from a 23% discount to NAV and attractive cash distribution policy of 5% yield p.a. Hence, we reiterate our Buy on BB Biotech shares.

Key changes

Target Price 106.50 to 164.50 ↑ 54.5%

Source: Deutsche Bank

Price/price relative

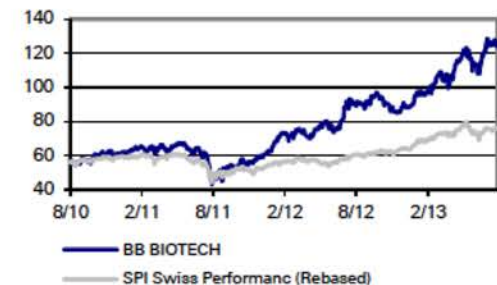

Performance (%)	1m	3m	12m
Absolute	-1.4	5.4	37.4

Test 3: Are you pricing or valuing?

173

	1	2	3	4	5
EBITDA	\$100.00	\$120.00	\$144.00	\$172.80	\$207.36
- Depreciation	\$20.00	\$24.00	\$28.80	\$34.56	\$41.47
EBIT	\$80.00	\$96.00	\$115.20	\$138.24	\$165.89
- Taxes	\$24.00	\$28.80	\$34.56	\$41.47	\$49.77
EBIT (1-t)	\$56.00	\$67.20	\$80.64	\$96.77	\$116.12
+ Depreciation	\$20.00	\$24.00	\$28.80	\$34.56	\$41.47
- Cap Ex	\$50.00	\$60.00	\$72.00	\$86.40	\$103.68
- Chg in WC	\$10.00	\$12.00	\$14.40	\$17.28	\$20.74
FCFF	\$16.00	\$19.20	\$23.04	\$27.65	\$33.18
Terminal Value					\$1,658.88
Cost of capital	8.25%	8.25%	8.25%	8.25%	8.25%
Present Value	\$14.78	\$16.38	\$18.16	\$20.14	\$1,138.35
Value of operating assets today	\$1,207.81				
+ Cash	\$125.00				
- Debt	\$200.00				
Value of equity	\$1,132.81				

The tool for pricing: A multiple

174

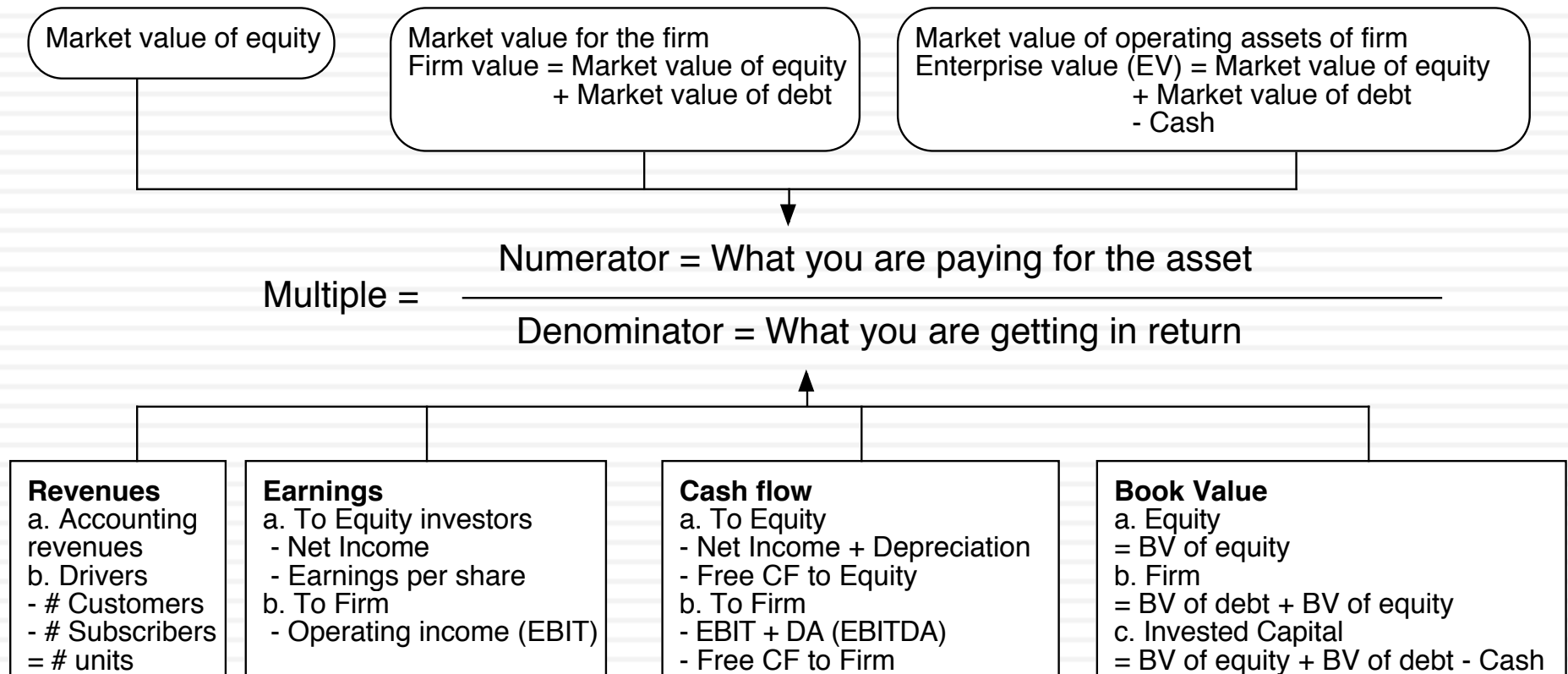

The Pricing Game: Choices

Measure	Choices	Considerations/ Questions
Value	Enterprise, Equity or Firm Value?	<ol style="list-style-type: none"> 1. Is this a financial service business? 2. Are there big differences in leverage?
Scalar	Revenues, Earnings, Cash Flows or Book Value?	<ol style="list-style-type: none"> 1. How are you measuring value? 2. Is the scaling number positive? 3. How (and how much) do accounting choices affect the scaling measure?
Timing & Normalizing	Current, Trailing, Forward or Really Forward?	<ol style="list-style-type: none"> 1. Where are you in the life cycle? 2. How much cyclicity is there in the number? 3. Can you get forecasted values?
Comparable	What is your peer group? (Global or local? Similar size or all firms? ...)	<ol style="list-style-type: none"> 1. How much do companies share in common globally? 2. Does company size affect business economics? 3. How big a sample of firms do you need? 4. How do you plan to control for differences?

The Four Steps to Deconstructing Multiples

- Define the multiple
 - In use, the same multiple can be defined in different ways by different users. When comparing and using multiples, estimated by someone else, it is critical that we understand how the multiples have been estimated
- Describe the multiple
 - Too many people who use a multiple have no idea what its cross sectional distribution is. If you do not know what the cross sectional distribution of a multiple is, it is difficult to look at a number and pass judgment on whether it is too high or low.
- Analyze the multiple
 - It is critical that we understand the fundamentals that drive each multiple, and the nature of the relationship between the multiple and each variable.
- Apply the multiple
 - Defining the comparable universe and controlling for differences is far more difficult in practice than it is in theory.

Definitional Tests

- Is the multiple consistently defined?
 - Proposition 1: Both the value (the numerator) and the standardizing variable (the denominator) should be to the same claimholders in the firm. In other words, the value of equity should be divided by equity earnings or equity book value, and firm value should be divided by firm earnings or book value.
- Is the multiple uniformly estimated?
 - The variables used in defining the multiple should be estimated uniformly across assets in the “comparable firm” list.
 - If earnings-based multiples are used, the accounting rules to measure earnings should be applied consistently across assets. The same rule applies with book-value based multiples.

Example 1: Price Earnings Ratio: Definition

PE = Market Price per Share / Earnings per Share

- There are a number of variants on the basic PE ratio in use. They are based upon how the price and the earnings are defined.

Price: is usually the current price

is sometimes the average price for the year

EPS: EPS in most recent financial year

EPS in trailing 12 months (Trailing PE)

Forecasted EPS next year (Forward PE)

Forecasted EPS in future year

Example 2: Enterprise Value /EBITDA Multiple

- The enterprise value to EBITDA multiple is obtained by netting cash out against debt to arrive at enterprise value and dividing by EBITDA.

$$\frac{\text{Enterprise Value}}{\text{EBITDA}} = \frac{\text{Market Value of Equity} + \text{Market Value of Debt} - \text{Cash}}{\text{Earnings before Interest, Taxes and Depreciation}}$$

- Why do we net out cash from firm value?
- What happens if a firm has cross holdings which are categorized as:
 - ▣ Minority interests?
 - ▣ Majority active interests?

Descriptive Tests

- What is the average and standard deviation for this multiple, across the universe (market)?
- What is the median for this multiple?
 - The median for this multiple is often a more reliable comparison point.
- How large are the outliers to the distribution, and how do we deal with the outliers?
 - Throwing out the outliers may seem like an obvious solution, but if the outliers all lie on one side of the distribution (they usually are large positive numbers), this can lead to a biased estimate.
- Are there cases where the multiple cannot be estimated? Will ignoring these cases lead to a biased estimate of the multiple?
- How has this multiple changed over time?

1. Multiples have skewed distributions...

PE ratios for US Companies in January 2018

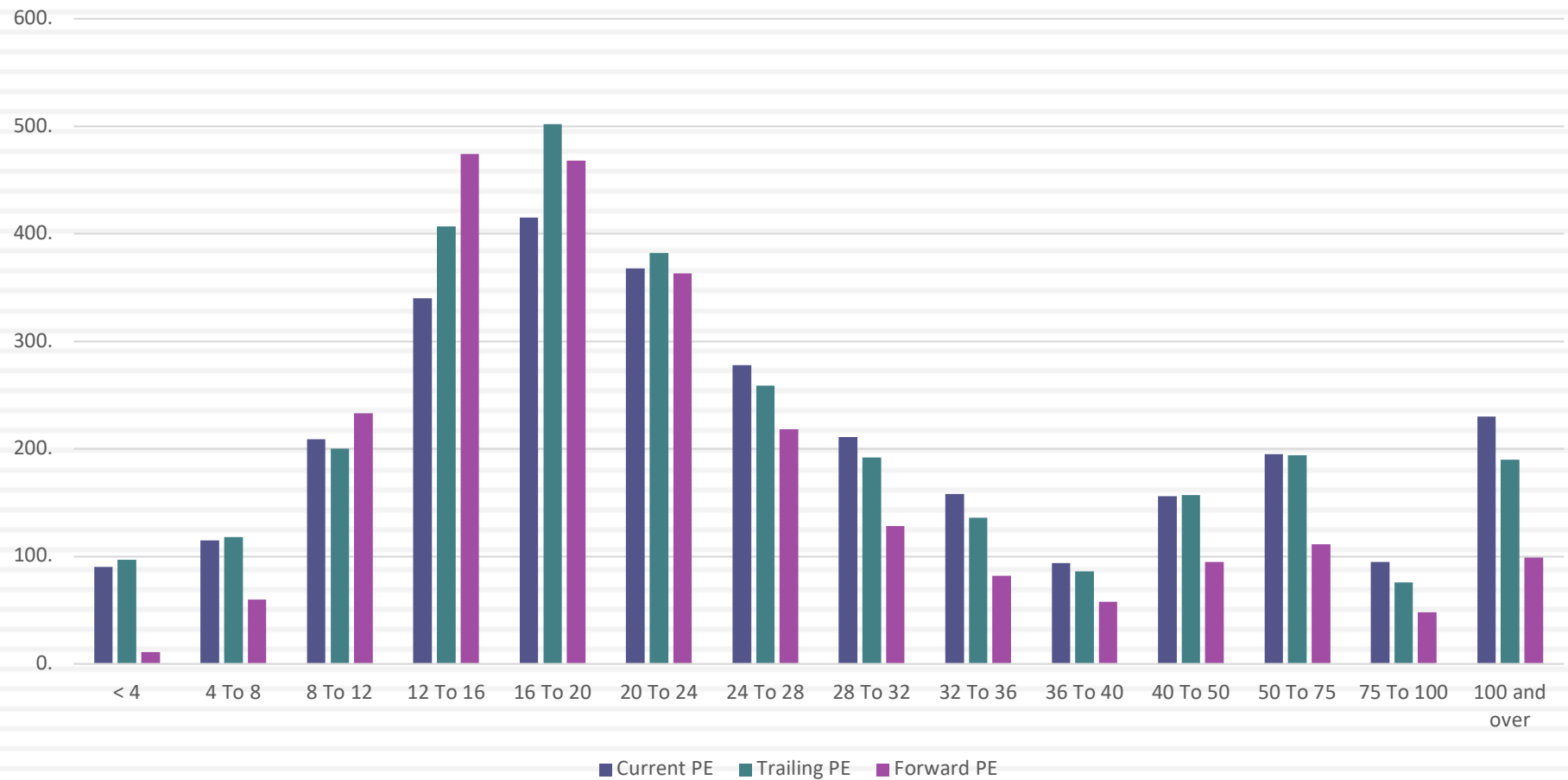

2. Making statistics “dicey”

182

	Current PE	Trailing PE	Forward PE
Number of firms	7,247	7,247	7,247
Number with PE	2,955	2,958	2,448
Average	71.28	65.33	41.75
Median	23.13	21.79	19.76
Minimum	0.05	0.07	0.3
Maximum	21,560	10,333	9,087
Standard deviation	491.39	401.07	251.2
Standard error	9.03	7.33	5.08
Skewness	80.51	73.51	80.08
25th percentile	15.86	15.41	14.86
75th percentile	37.22	34.38	28.19

US firms in January 2018

3. Markets have a lot in common : Comparing Global PEs

PE ratios across the globe on January 1, 2018

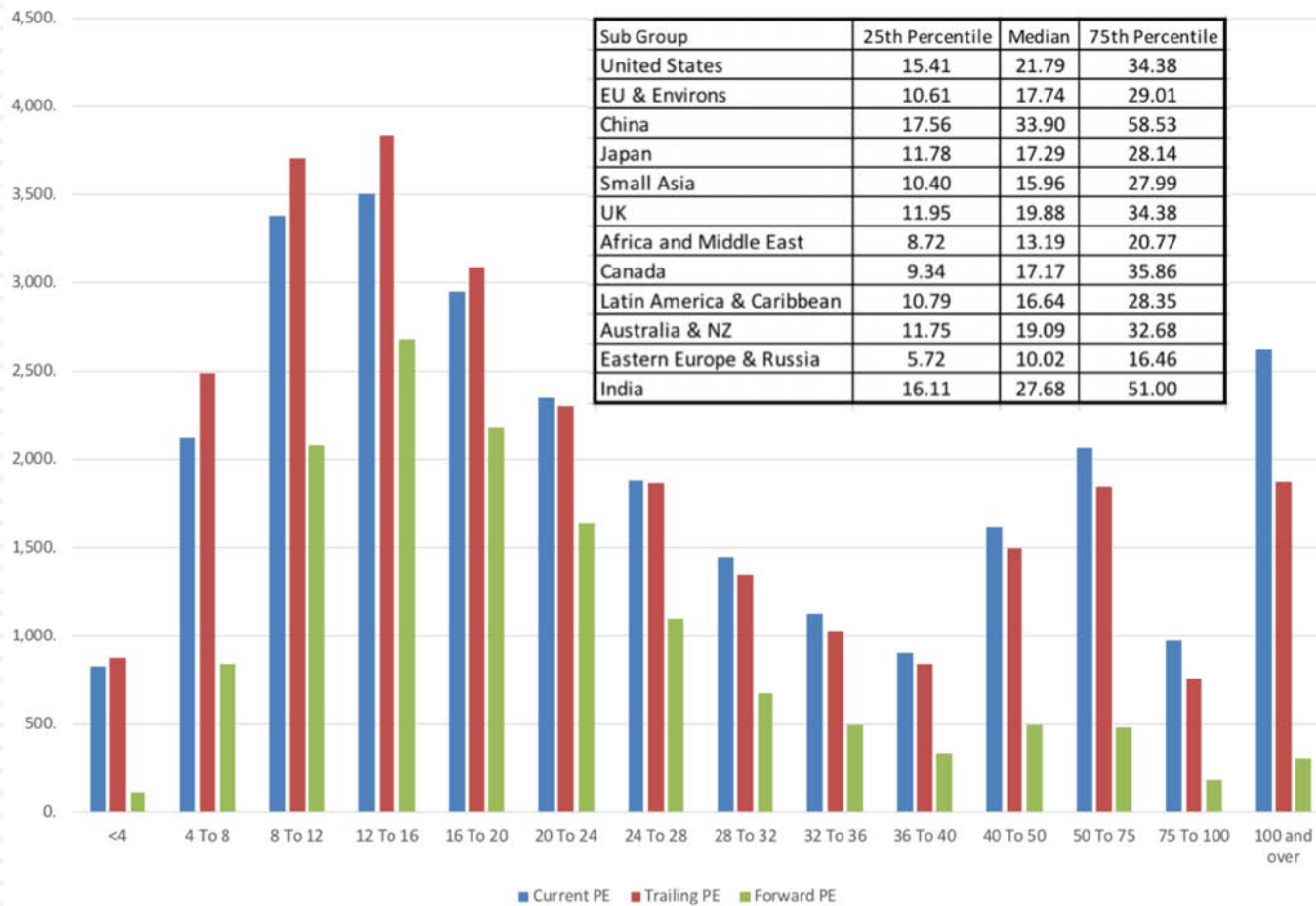

4. Simplistic rules almost always break down...6 times EBITDA may not be cheap...

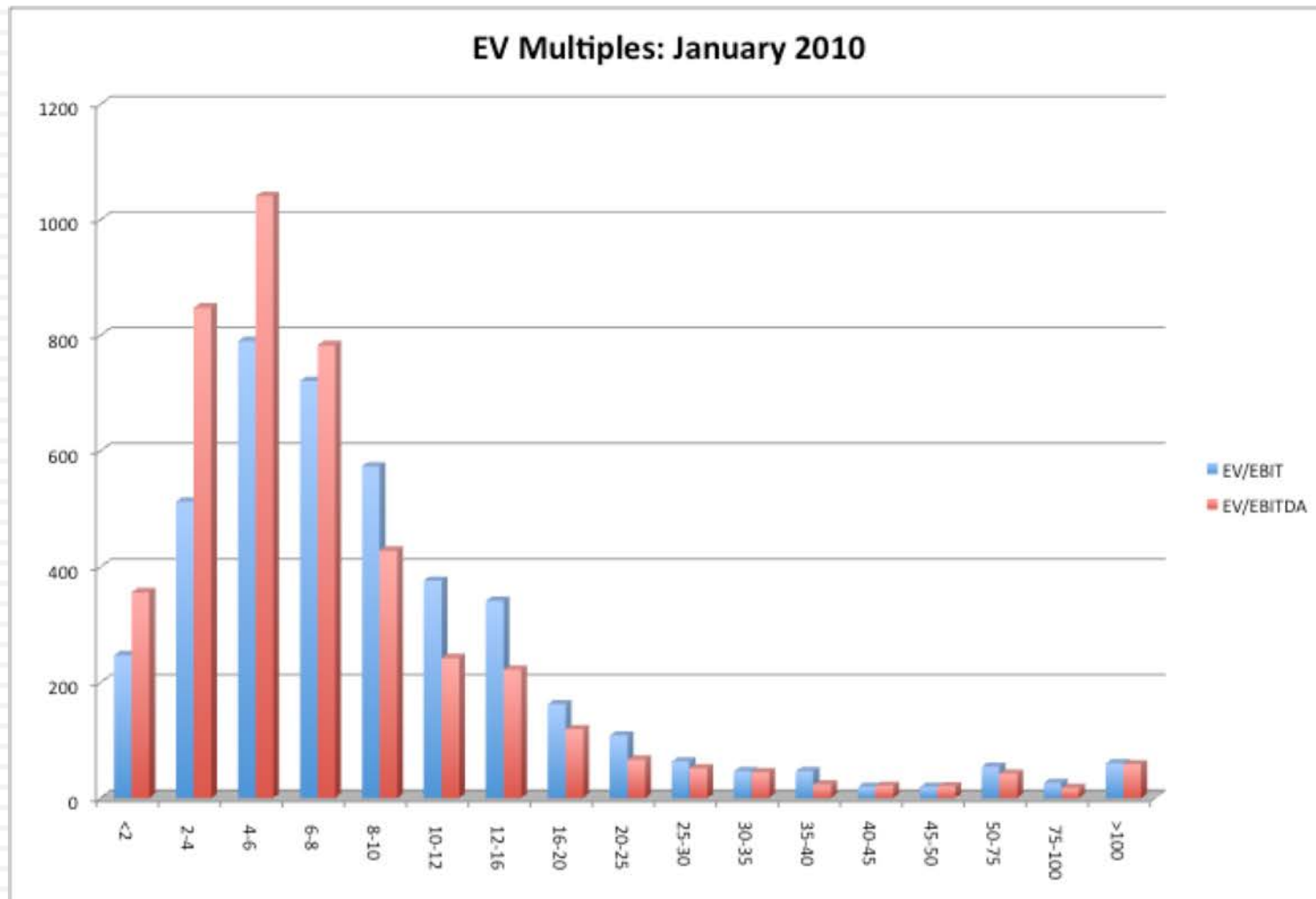

But it may be in 2018, unless you are in Russia!

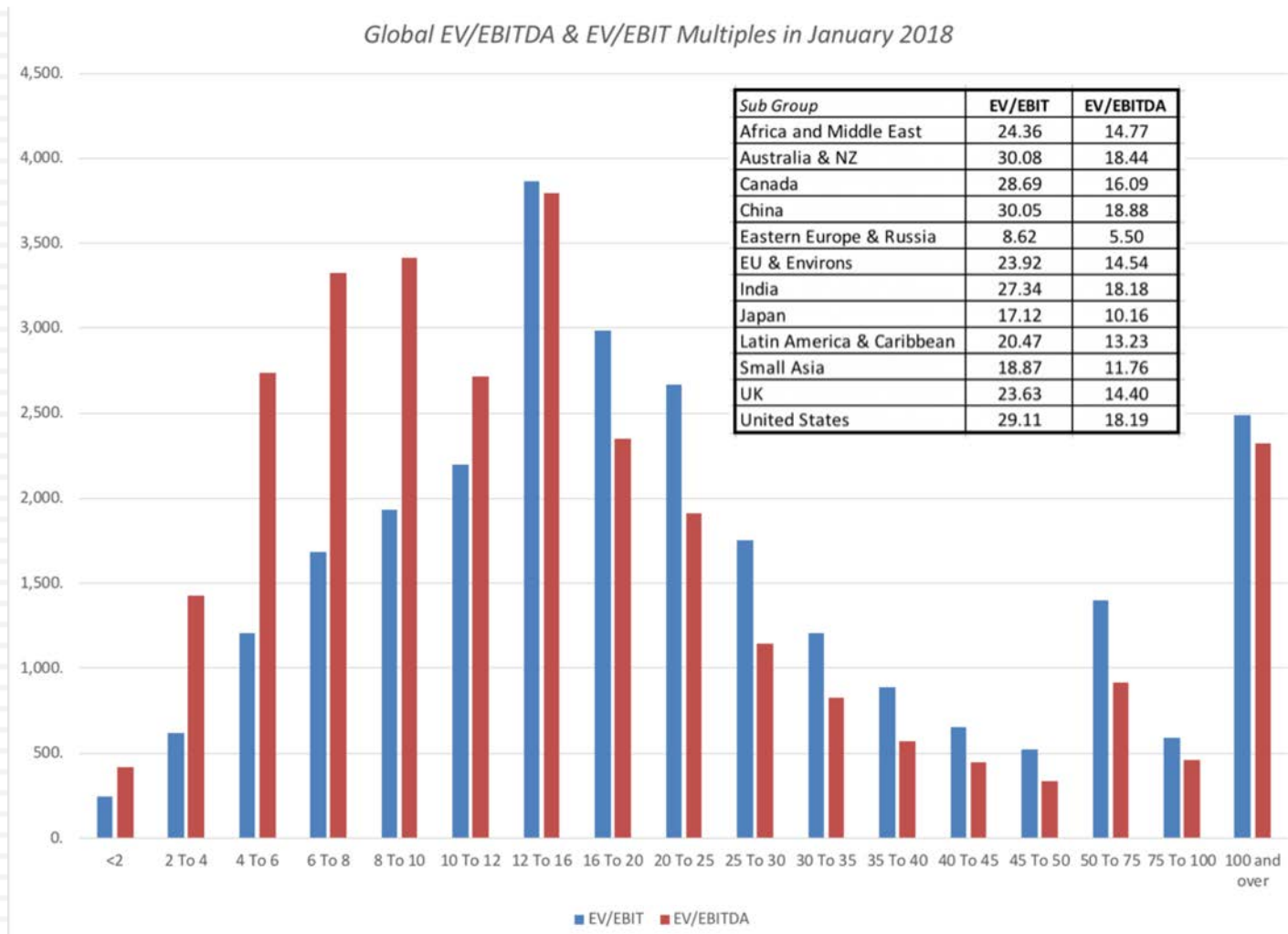

Analytical Tests

- What are the fundamentals that determine and drive these multiples?
 - Proposition 2: Embedded in every multiple are all of the variables that drive every discounted cash flow valuation - growth, risk and cash flow patterns.
 - In fact, using a simple discounted cash flow model and basic algebra should yield the fundamentals that drive a multiple
- How do changes in these fundamentals change the multiple?
 - The relationship between a fundamental (like growth) and a multiple (such as PE) is seldom linear. For example, if firm A has twice the growth rate of firm B, it will generally not trade at twice its PE ratio
 - Proposition 3: It is impossible to properly compare firms on a multiple, if we do not know the nature of the relationship between fundamentals and the multiple.

A Simple Analytical device

	<p><i>Start with a basic intrinsic value model</i></p>	<p><i>Divide both sides of the equation by the denominator of the multiple that you are trying to deconstruct.</i></p>	<p>You should end up with an intrinsic version of your multiple, which should relate it to fundamentals.</p>
If Equity Multiple	<p>Start with a dividend or FCFE model, preferably simple.</p>	<p>Divide your dividend or FCFE model by denominator of equity multiple.</p>	<p>Intrinsic version of equity multiple, with drivers of value</p>
	<p>Price = $EPS * Payout / (r - g)$</p>	<p>Price/Book = $ROE * Payout / (r - g)$</p>	<p>Price/Book = $f(ROE, r, g, Payout)$</p>
If EV Multiple	<p>Start with a operating asset value model, preferably simple.</p>	<p>Divide your operating asset model by denominator of EV multiple.</p>	<p>Intrinsic version of EV multiple, with drivers of value</p>
	<p>EV = $EBIT (1-t) (1 - RIR) / (WACC - g)$</p>	<p>EV/Sales = $After-tax Operating Margin (1 - RIR) / (WACC - g)$</p>	<p>EV/Sales = $f(After-tax Operating Margin, RIR, WACC, g)$</p>

PE Ratio: Understanding the Fundamentals

- To understand the fundamentals, start with a basic equity discounted cash flow model.
- With the dividend discount model,

$$P_0 = \frac{DPS_1}{r - g_n}$$

- Dividing both sides by the current earnings per share,

$$\frac{P_0}{EPS_0} = PE = \frac{\text{Payout Ratio} * (1 + g_n)}{r - g_n}$$

- If this had been a FCFE Model,

$$P_0 = \frac{FCFE_1}{r - g_n}$$

$$\frac{P_0}{EPS_0} = PE = \frac{(\text{FCFE/Earnings}) * (1 + g_n)}{r - g_n}$$

The Determinants of Multiples...

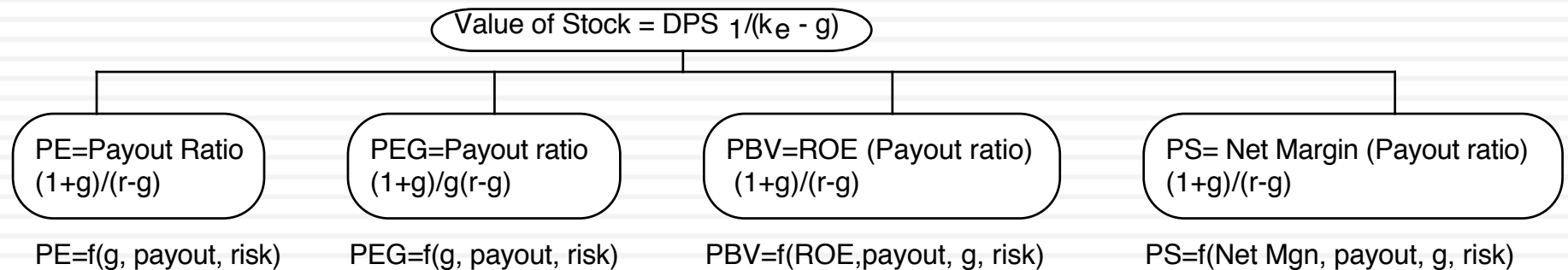

Firm Multiples

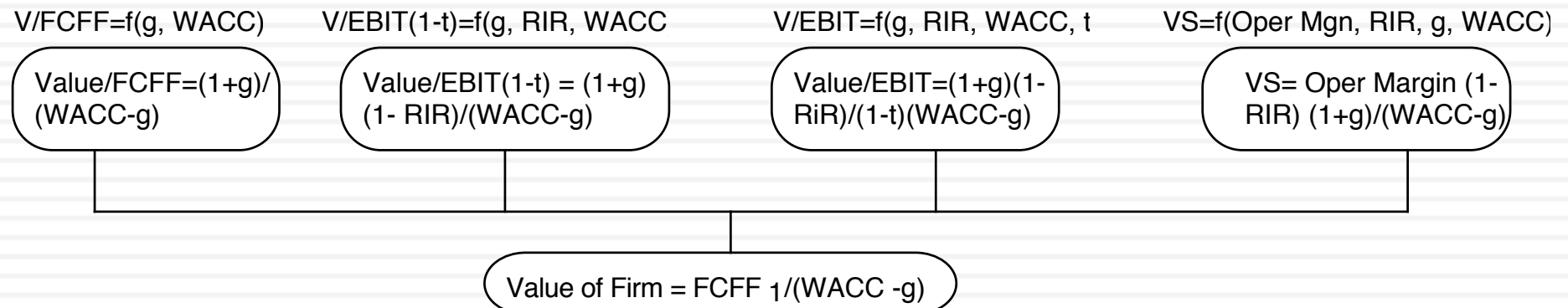

Application Tests

- Given the firm that you are valuing, what is a “comparable” firm?
 - ▣ While traditional analysis is built on the premise that firms in the same sector are comparable firms, valuation theory would suggest that a comparable firm is one which is similar to the one being analyzed in terms of fundamentals.
 - ▣ Proposition 4: There is no reason why a firm cannot be compared with another firm in a very different business, if the two firms have the same risk, growth and cash flow characteristics.
- Given the comparable firms, how do you adjust for differences across firms on the fundamentals?
 - ▣ Proposition 5: It is impossible to find an exactly identical firm to the one you are valuing.

An Example: Comparing PE Ratios across a Sector: PE

<i>Company Name</i>	<i>PE</i>	<i>Growth</i>
<i>PT Indosat ADR</i>	<i>7.8</i>	<i>0.06</i>
<i>Telebras ADR</i>	<i>8.9</i>	<i>0.075</i>
<i>Telecom Corporation of New Zealand ADR</i>	<i>11.2</i>	<i>0.11</i>
<i>Telecom Argentina Stet - France Telecom SA ADR B</i>	<i>12.5</i>	<i>0.08</i>
<i>Hellenic Telecommunication Organization SA ADR</i>	<i>12.8</i>	<i>0.12</i>
<i>Telecomunicaciones de Chile ADR</i>	<i>16.6</i>	<i>0.08</i>
<i>Swisscom AG ADR</i>	<i>18.3</i>	<i>0.11</i>
<i>Asia Satellite Telecom Holdings ADR</i>	<i>19.6</i>	<i>0.16</i>
<i>Portugal Telecom SA ADR</i>	<i>20.8</i>	<i>0.13</i>
<i>Telefonos de Mexico ADR L</i>	<i>21.1</i>	<i>0.14</i>
<i>Matav RT ADR</i>	<i>21.5</i>	<i>0.22</i>
<i>Telstra ADR</i>	<i>21.7</i>	<i>0.12</i>
<i>Gilat Communications</i>	<i>22.7</i>	<i>0.31</i>
<i>Deutsche Telekom AG ADR</i>	<i>24.6</i>	<i>0.11</i>
<i>British Telecommunications PLC ADR</i>	<i>25.7</i>	<i>0.07</i>
<i>Tele Danmark AS ADR</i>	<i>27</i>	<i>0.09</i>
<i>Telekomunikasi Indonesia ADR</i>	<i>28.4</i>	<i>0.32</i>
<i>Cable & Wireless PLC ADR</i>	<i>29.8</i>	<i>0.14</i>
<i>APT Satellite Holdings ADR</i>	<i>31</i>	<i>0.33</i>
<i>Telefonica SA ADR</i>	<i>32.5</i>	<i>0.18</i>
<i>Royal KPN NV ADR</i>	<i>35.7</i>	<i>0.13</i>
<i>Telecom Italia SPA ADR</i>	<i>42.2</i>	<i>0.14</i>
<i>Nippon Telegraph & Telephone ADR</i>	<i>44.3</i>	<i>0.2</i>
<i>France Telecom SA ADR</i>	<i>45.2</i>	<i>0.19</i>
<i>Korea Telecom ADR</i>	<i>71.3</i>	<i>0.44</i>

PE, Growth and Risk

□ Dependent variable is: PE

□ R squared = 66.2% R squared (adjusted) = 63.1%

<i>Variable</i>	<i>Coefficient</i>	<i>SE</i>	<i>t-ratio</i>	<i>Probability</i>
Constant	13.1151	3.471	3.78	0.0010
Growth rate	121.223	19.27	6.29	≤ 0.0001
Emerging Market	-13.853	3.606	-3.84	0.0009
Emerging Market is a dummy:	1 if emerging market 0 if not			

□ Is Indosat cheap?

$$PE = 13.13 + 121.22 (.06) - 13.85 (1) = 6.55$$

At 7.8 times earnings, Indosat is over valued.

Vinamilk: Priced against South East Asian food companies

Country	Number	PE	PBV	EV/EBITDA	EV/Sales	EV/Invested Capital
Indonesia	16	20.75	3.49	35.52	8.40	3.55
Malaysia	39	42.95	4.54	20.60	2.20	7.75
Philippines	13	52.84	3.52	22.86	3.77	2.55
Singapore	1	9.27	1.56	7.62	0.65	1.33
Thailand	34	22.75	1.92	33.42	1.41	1.89
Vietnam	8	21.63	3.47	15.65	1.74	3.59
SE Asia	111	38.63	3.03	39.16	2.74	3.93
		PE	PBV	EV/EBITDA	EV/Sales	EV/Invested Capital
Vinamilk		25.68	11.31	19.90	4.97	20.36
vs Vietnam		18.71%	226.28%	27.11%	186.07%	466.42%
vs SE Asia		-33.52%	273.21%	-49.19%	81.47%	418.55%

Controlling for Differences?

- There are clear differences in fundamentals across building supplies companies, especially when it comes to margins and ROE, which may explain variation in pricing multiples. For instance,
 - Vinamilk has an operating margin of 22.39%, much higher than the margins for other Vietnamese food companies (5.14%) and other SE Asian food companies (4.74%)
 - Vinamilk also has a much higher return on capital (77.12%) than the typical food company in Vietnam (8.20%) or SE Asia (10.93%)
 - Regressing EV/Invested Capital against ROIC, for instance:
 - $EV/IC = 0.75 + 28.85 ROIC \quad R^2 = 43.8\%$
 - Plugging in Vinamilk's ROIC (77.12%) into the regression, we get:
 - $EV/IC = 0.75 + 28.85 (.7712) = 23.00$
- At 20.36 times invested capital, Vinamilk looks under priced (by about 15%) against other SE Asian food companies.

Comparisons to the entire market: Why not?

- In contrast to the 'comparable firm' approach, the information in the entire cross-section of firms can be used to predict PE ratios.
- The simplest way of summarizing this information is with a multiple regression, with the PE ratio as the dependent variable, and proxies for risk, growth and payout forming the independent variables.

PE Ratio: Standard Regression for US stocks - January 2018

196

Model Summary^{a,c,d}

Model	R	R Square	Adjusted R Square	Std. Error of the Estimate
1	.611 ^b	.373	.372	2322.83634

a. Broad Group = United States

b. Predictors: (Constant), Expected growth rate in EPS- Next 5 years, Payout ratio, Beta

c. Dependent Variable: Trailing PE

d. Weighted Least Squares Regression – Weighted by Market Cap (in US \$)

The regression is run with growth and payout entered as decimals, i.e., 25% is entered as 0.25)

Coefficients^{a,b,c}

Model		Unstandardized Coefficients		Standardized Coefficients	t	Sig.
		B	Std. Error	Beta		
1	(Constant)	5.905	1.567		3.767	.000
	Beta	1.637	1.546	.023	1.059	.290
	Payout ratio	17.434	.826	.448	21.115	.000
	Expected growth rate in EPS- Next 5 years	113.715	5.324	.439	21.359	.000

a. Broad Group = United States

b. Dependent Variable: Trailing PE

c. Weighted Least Squares Regression – Weighted by Market Cap (in US \$)

PE ratio regressions across markets – January 2018

197

Region	Regression – January 2017	R ²
US	PE = 5.91 + 1.64 Beta + 17.43 Payout + 113.72 g _{EPS}	37.2%
Europe	PE = 17.68 – 2.08 Beta + 12.55 Payout + 21.98 g _{EPS}	23.6%
Japan	PE = 14.62 – 1.83 Beta + 23.37 Payout + 14.06 g _{EPS}	16.8%
Emerging Markets	PE = 16.36 – 1.44 Beta + 5.33 Payout + 50.15 g _{EPS}	24.5%
Australia, NZ, Canada	PE = 17.05 – 3.89 Beta + 14.05 Payout + 22.70 g _{EPS}	13.6%
Global	PE = 17.46 – 2.74 Beta + 13.32 Payout + 44.37 g _{EPS}	23.2%

g_{EPS} = Expected Growth: Expected growth in EPS or Net Income: Next 5 years

Beta: Regression or Bottom up Beta

Payout ratio: Dividends/ Net income from most recent year. Set to zero, if net income < 0

Choosing Between the Multiples

- As presented in this section, there are dozens of multiples that can be potentially used to value an individual firm.
- In addition, relative valuation can be relative to a sector (or comparable firms) or to the entire market (using the regressions, for instance)
- Since there can be only one final estimate of value, there are three choices at this stage:
 - Use a simple average of the valuations obtained using a number of different multiples
 - Use a weighted average of the valuations obtained using a number of different multiples
 - Choose one of the multiples and base your valuation on that multiple

Picking one Multiple

- This is usually the best way to approach this issue. While a range of values can be obtained from a number of multiples, the “best estimate” value is obtained using one multiple.
- The multiple that is used can be chosen in one of two ways:
 - Use the multiple that best fits your objective. Thus, if you want the company to be undervalued, you pick the multiple that yields the highest value.
 - Use the multiple that has the highest R-squared in the sector when regressed against fundamentals. Thus, if you have tried PE, PBV, PS, etc. and run regressions of these multiples against fundamentals, use the multiple that works best at explaining differences across firms in that sector.
 - Use the multiple that seems to make the most sense for that sector, given how value is measured and created.

Conventional usage...

Sector	Multiple Used	Rationale
Cyclical Manufacturing	PE, Relative PE	Often with normalized earnings
Growth firms	PEG ratio	Big differences in growth rates
Young growth firms w/ losses	Revenue Multiples	What choice do you have?
Infrastructure	EV/EBITDA	Early losses, big DA
REIT	P/CFE (where CFE = Net income + Depreciation)	Big depreciation charges on real estate
Financial Services	Price/ Book equity	Marked to market?
Retailing	Revenue multiples	Margins equalize sooner or later

A closing thought...

