

Website: <http://www.damodaran.com>

Blog: <http://aswathdamodaran.blogspot.com>

Twitter: @AswathDamodaran

App (iPad/iPhone): [uValue \(in iTunes app store\)](#)

Aswath Damodaran

VALUATION: ART, SCIENCE, CRAFT OR MAGIC?

Aswath Damodaran
www.damodaran.com

Some Initial Thoughts

" One hundred thousand lemmings cannot be wrong"

Graffiti

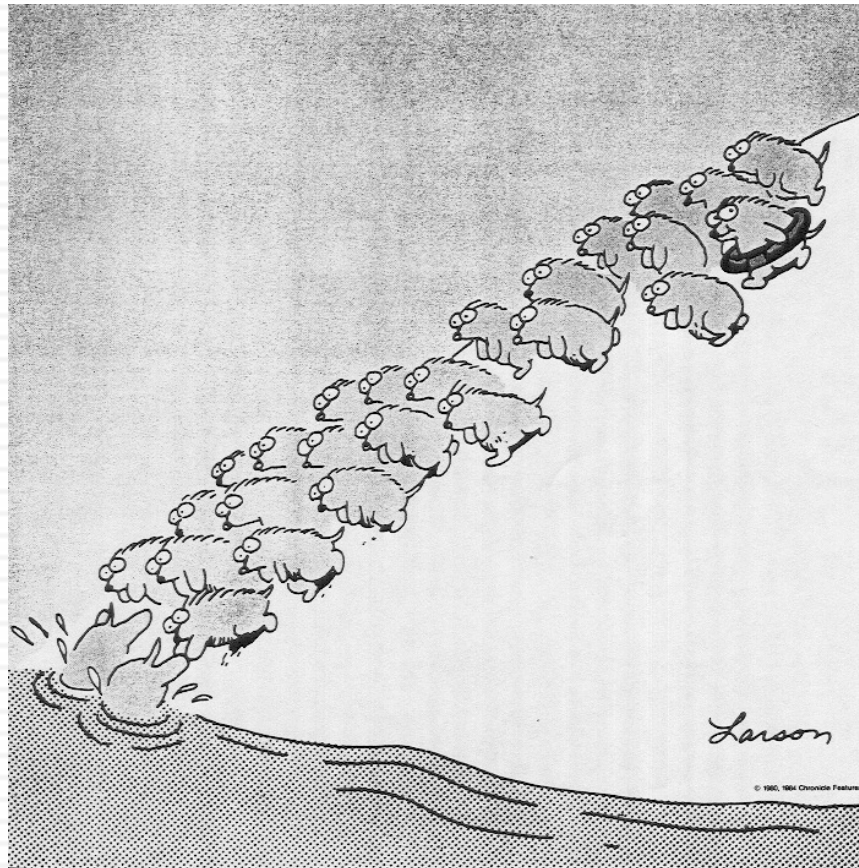

Aswath Damodaran

Misconceptions about Valuation

- Myth 1: A valuation is an objective search for “true” value
 - ▣ Truth 1.1: All valuations are biased. The only questions are how much and in which direction.
 - ▣ Truth 1.2: The direction and magnitude of the bias in your valuation is directly proportional to who pays you and how much you are paid.
- Myth 2.: A good valuation provides a precise estimate of value
 - ▣ Truth 2.1: There are no precise valuations
 - ▣ Truth 2.2: The payoff to valuation is greatest when valuation is least precise.
- Myth 3: . The more quantitative a model, the better the valuation
 - ▣ Truth 3.1: One’ s understanding of a valuation model is inversely proportional to the number of inputs required for the model.
 - ▣ Truth 3.2: Simpler valuation models do much better than complex ones.

Approaches to Valuation

- **Intrinsic valuation**, relates the value of an asset to the present value of expected future cashflows on that asset. In its most common form, this takes the form of a discounted cash flow valuation.
- **Relative valuation**, estimates the value of an asset by looking at the pricing of 'comparable' assets relative to a common variable like earnings, cashflows, book value or sales.
- **Contingent claim valuation**, uses option pricing models to measure the value of assets that share option characteristics.

Discounted Cash Flow Valuation

- *What is it:* In discounted cash flow valuation, the value of an asset is the present value of the expected cash flows on the asset.
- *Philosophical Basis:* Every asset has an intrinsic value that can be estimated, based upon its characteristics in terms of cash flows, growth and risk.
- *Information Needed:* To use discounted cash flow valuation, you need
 - to estimate the life of the asset
 - to estimate the cash flows during the life of the asset
 - to estimate the discount rate to apply to these cash flows to get present value
- *Market Inefficiency:* Markets are assumed to make mistakes in pricing assets across time, and are assumed to correct themselves over time, as new information comes out about assets.

Intrinsic Value: Four Basic Propositions

6

The value of an asset is the present value of the expected cash flows on that asset, over its expected life:

$$\text{Value of asset} = \frac{E(\text{CF}_1)}{(1+r)} + \frac{E(\text{CF}_2)}{(1+r)^2} + \frac{E(\text{CF}_3)}{(1+r)^3} \dots + \frac{E(\text{CF}_n)}{(1+r)^n}$$

1. *The IT Proposition:* If “it” does not affect the cash flows or alter risk (thus changing discount rates), “it” cannot affect value.
2. *The DUH Proposition:* For an asset to have value, the expected cash flows have to be positive some time over the life of the asset.
3. *The DON'T FREAK OUT Proposition:* Assets that generate cash flows early in their life will be worth more than assets that generate cash flows later; the latter may however have greater growth and higher cash flows to compensate.
4. *The VALUE IS NOT PRICE Proposition:* The value of an asset may be very different from its price.

DCF Choices: Equity Valuation versus Firm Valuation

Firm Valuation: Value the entire business

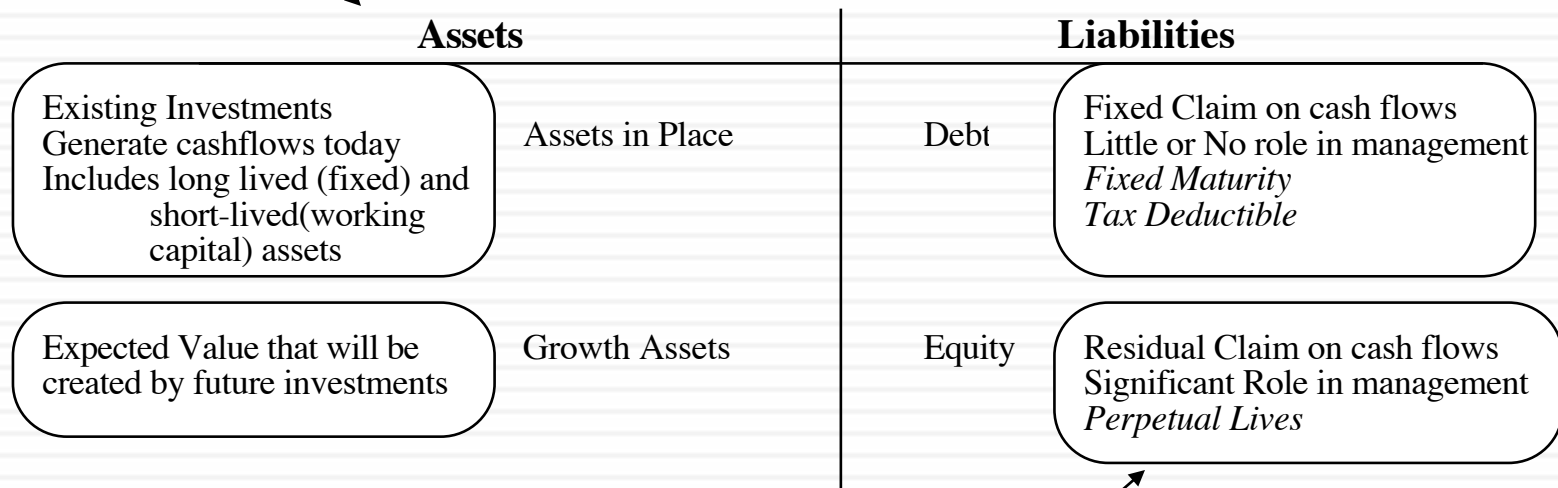

Equity valuation: Value just the equity claim in the business

The Drivers of Value...

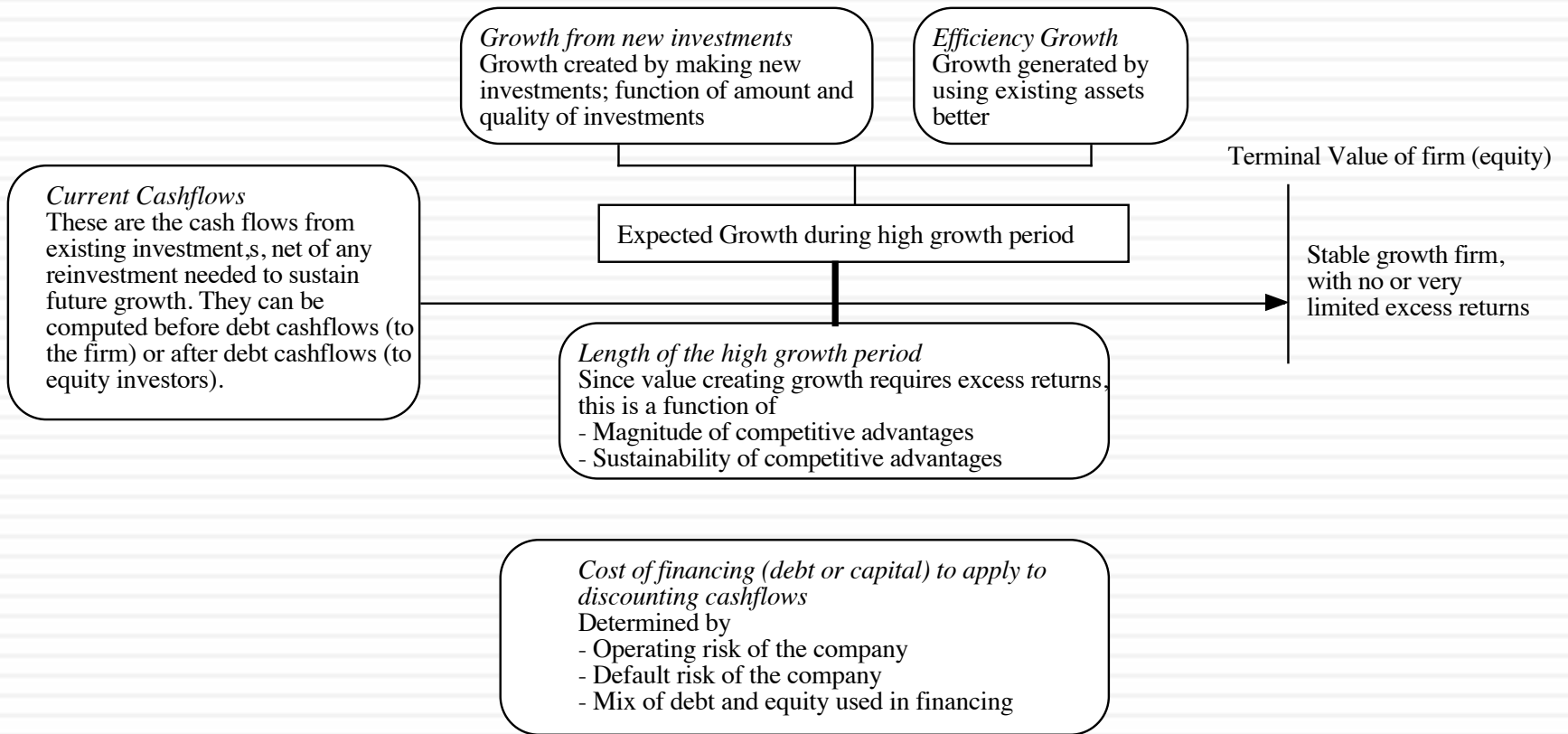

DISCOUNTED CASHFLOW VALUATION

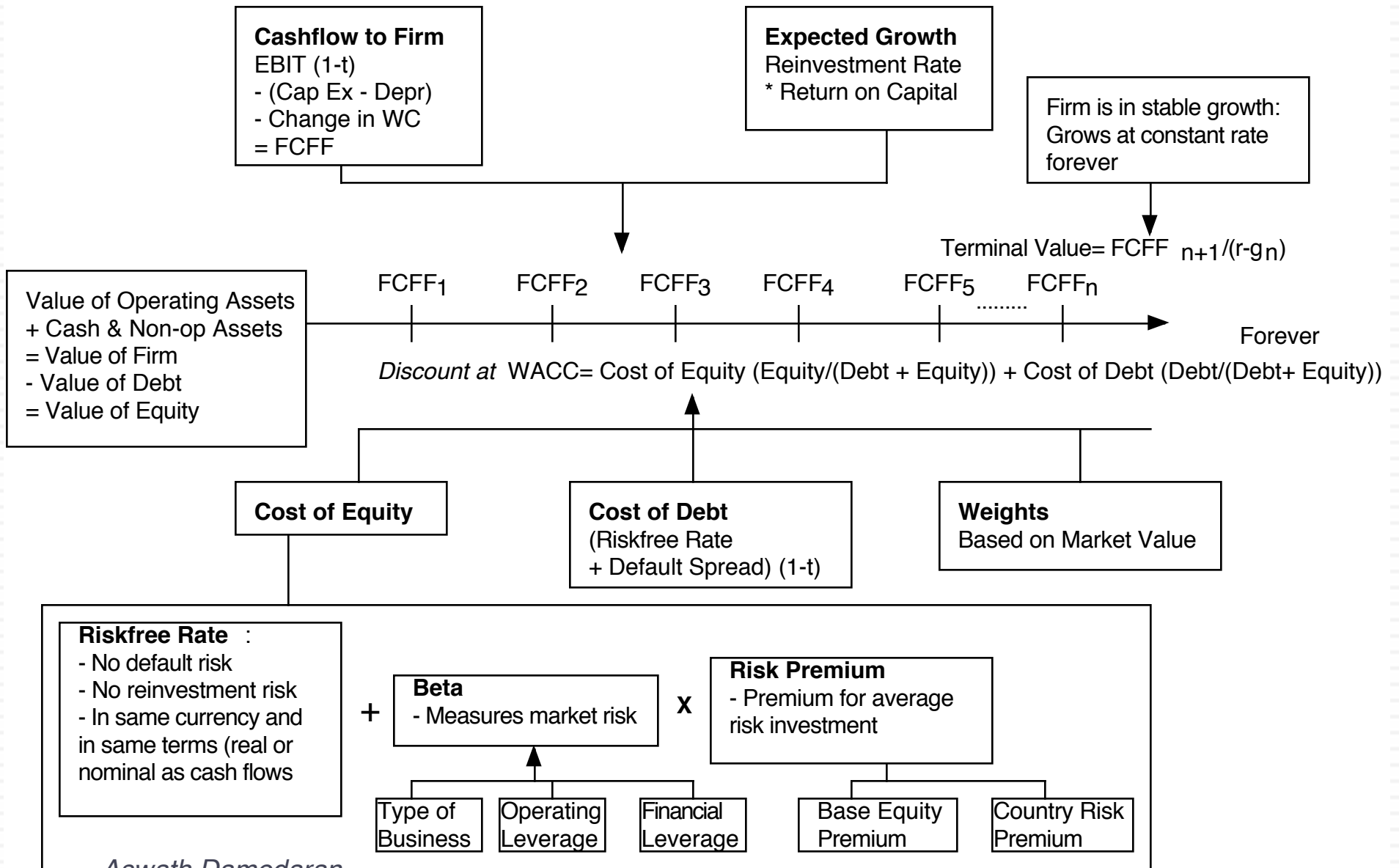

Amgen: Status Quo

Cap Ex = Acc net Cap Ex(255) +
Acquisitions (3975) + R&D (2216)

Current Cashflow to Firm

EBIT(1-t) = :7336(1-.28) = 6058
 - Nt CpX = 6443
 - Chg WC 37
 = FCFF - 423
 Reinvestment Rate = 6480/6058
 = 106.98%
 Return on capital = 16.71%

Reinvestment Rate
60%

Expected Growth
in EBIT (1-t)
.60*.16=.096
9.6%

Return on Capital
16%

Stable Growth

g = 4%; Beta = 1.10;
Debt Ratio = 20%; Tax rate = 35%
Cost of capital = 8.08%
ROC = 10.00%;
Reinvestment Rate = 4/10 = 40%

Terminal Value₁₀ = 7300 / (.0808 - .04) = 179,099

First 5 years

Growth decreases
gradually to 4%

Op. Assets 94214
+ Cash: 1283
- Debt 8272
= Equity 87226
- Options 479
Value/Share \$ 74.33

Year	1	2	3	4	5	6	7	8	9	10
EBIT	\$9,221	\$10,106	\$11,076	\$12,140	\$13,305	\$14,433	\$15,496	\$16,463	\$17,306	\$17,998
EBIT (1-t)	\$6,639	\$7,276	\$7,975	\$8,741	\$9,580	\$10,392	\$11,157	\$11,853	\$12,460	\$12,958
- Reinvestment	\$3,983	\$4,366	\$4,785	\$5,244	\$5,748	\$5,820	\$5,802	\$5,690	\$5,482	\$5,183
= FCFF	\$2,656	\$2,911	\$3,190	\$3,496	\$3,832	\$4,573	\$5,355	\$6,164	\$6,978	\$7,775

Term Yr
18718
12167
4867
7300

Cost of Capital (WACC) = 11.7% (0.90) + 3.66% (0.10) = 10.90%

Debt ratio increases to 20%
Beta decreases to 1.10

Cost of Equity
11.70%

Cost of Debt
(4.78% + .85%)(1-.35)
= 3.66%

Weights
E = 90% D = 10%

On May 1, 2007,
Amgen was trading
at \$ 55/share

Riskfree Rate:
Riskfree rate = 4.78%

+

Beta
1.73

x

Risk Premium
4%

Unlevered Beta for
Sectors: 1.59

D/E = 11.06%

Aswath Damodaran

Tata Motors: April 2010

Current Cashflow to Firm

EBIT(1-t) : Rs 20,116
 - Nt CpX : Rs 31,590
 - Chg WC : Rs 2,732
 = FCFF : - Rs 14,205
 Reinv Rate = $(31590+2732)/20116 = 170.61\%$; Tax rate = 21.00%
 Return on capital = 17.16%

Average reinvestment rate
 from 2005-09: 179.59%;
 without acquisitions: 70%

Reinvestment Rate
 70%

Expected Growth
 from new inv.
 $70 \cdot 17.16 = 0.1201$

Return on Capital
 17.16%

Stable Growth
 $g = 5\%$; Beta = 1.00
 Country Premium = 3%
 Cost of capital = 10.39%
 Tax rate = 33.99%
 ROC = 10.39%;
 Reinvestment Rate = $g/ROC = 5/10.39 = 48.11\%$

Rs Cashflows

Year	1	2	3	4	5	6	7	8	9	10
EBIT (1-t)	22533	25240	28272	31668	35472	39236	42848	46192	49150	51607
- Reinvestment	15773	17668	19790	22168	24830	25242	25138	24482	23264	21503
FCFF	6760	7572	8482	9500	10642	13994	17711	21710	25886	30104

Terminal Value₅ = $23493 / (.1039 - .05) = \text{Rs } 435,686$

45278
 21785
 23493

Op. Assets Rs 210,813
 + Cash: 11418
 + Other NO 140576
 - Debt 109198
 = Equity 253,628

Value/Share Rs 614

Discount at Cost of Capital (WACC) = $14.00\% (.747) + 8.09\% (0.253) = 12.50\%$

Growth declines to 5%
 and cost of capital
 moves to stable period
 level.

Cost of Equity
 14.00%

Cost of Debt
 $(5\% + 4.25\% + 3\%)(1 - .3399)$
 = 8.09%

Weights
 E = 74.7% D = 25.3%

On April 1, 2010
 Tata Motors price = Rs 781

Riskfree Rate:
 Rs Riskfree Rate = 5%

+

Beta
 1.20

X

Mature market
 premium
 4.5%

+

Lambda
 0.80

X

Country Equity Risk
 Premium
 4.50%

Aswath Damodaran

Unlevered Beta for
 Sectors: 1.04

Firm's D/E
 Ratio: 33%

Country Default
 Spread
 3%

X

Rel Equity
 Mkt Vol
 1.50

Natura (February 2014)

Current Cashflow to Firm
 EBIT(1-t) = 1,338 (1-.3165) = R\$ 914
 - Nt CpX = 603- 150 = R\$ 453
 - Chg WC = R\$ 46
 = FCFF = R\$415
 Reinv Rate = (453+46)/914= 54.6%
 Return on capital = 914/2226 = 39.66%

Reinvestment Rate
54.6%

Return on Capital
39.66%

Expected Growth from new investments
 $.546 \times .3966 = 0.2165$

Stable Growth
 g = 10%; Beta = 1.00
 Cost of capital = 16.35%
 Tax rate = 34.00%
 ROC= 25%;
 Reinvestment Rate=g/ROC
 =10%/ 25%= 40%

Terminal Value₁₀ = 3,072/(.1635-.10) = R\$48,394

Op. Assets R\$ 14,397
 + Cash: R\$ 960
 - Debt R\$ 2,610
 - Min Int. R\$ 18
 =Equity R\$ 12,731
 - Options R\$ 65
Value/Share Rs 28.67

Year	2014	2015	2016	2017	2018	2019	2020	2021	2022	2023
EBIT	R\$ 1,628	R\$ 1,980	R\$ 2,409	R\$ 2,931	R\$ 3,565	R\$ 4,254	R\$ 4,977	R\$ 5,707	R\$ 6,410	R\$ 7,051
Tax rate	31.89%	32.12%	32.36%	32.59%	32.83%	33.06%	33.30%	33.53%	33.77%	34.00%
EBIT (1-t)	R\$ 1,109	R\$ 1,344	R\$ 1,629	R\$ 1,975	R\$ 2,395	R\$ 2,848	R\$ 3,320	R\$ 3,793	R\$ 4,246	R\$ 4,654
- Reinvestment	R\$ 605	R\$ 734	R\$ 890	R\$ 1,079	R\$ 1,307	R\$ 1,472	R\$ 1,619	R\$ 1,739	R\$ 1,822	R\$ 1,862
= FCFF	R\$ 503	R\$ 610	R\$ 740	R\$ 897	R\$ 1,087	R\$ 1,376	R\$ 1,701	R\$ 2,054	R\$ 2,424	R\$ 2,792

Terminal year (2024)
 EBIT (1-t) =R\$5,119
 - Reinvestment =R\$2,048
 = FCFF = R\$3,072

Cost of capital = 19.83% (1-.8665) + 9.56% (.1335) = 18.46%

Growth declines to 10% and cost of capital moves to stable period level.

Cost of Equity 19.83%

Cost of Debt
 (11.28%+1.90%+1.30%)(1-.34) = 9.56%

Weights
 E = 86.65% D = 13.35%

On February 14, 2014
 Natura Price = \$R 38.34/share

Riskfree Rate:
 Rs Riskfree Rate= 11.28%

Beta 1.07

x

Equity Risk Premium 7.98%

Unlevered Beta for Sectors: 0.97

Firm's D/E Ratio: 15.4%

Brazil	88.72%	7.85%	88.72%
Argentina	2.57%	14.75%	2.57%
Chile	2.57%	5.90%	2.57%
Peru	2.57%	7.85%	2.57%
Mexico	1.79%	7.40%	1.79%
Colombia	1.79%	8.30%	1.79%
Natura	100.00%	7.98%	100.00%

Aswath Damodaran



DCF INPUTS

“Garbage in, garbage out”

I. Measure earnings right..

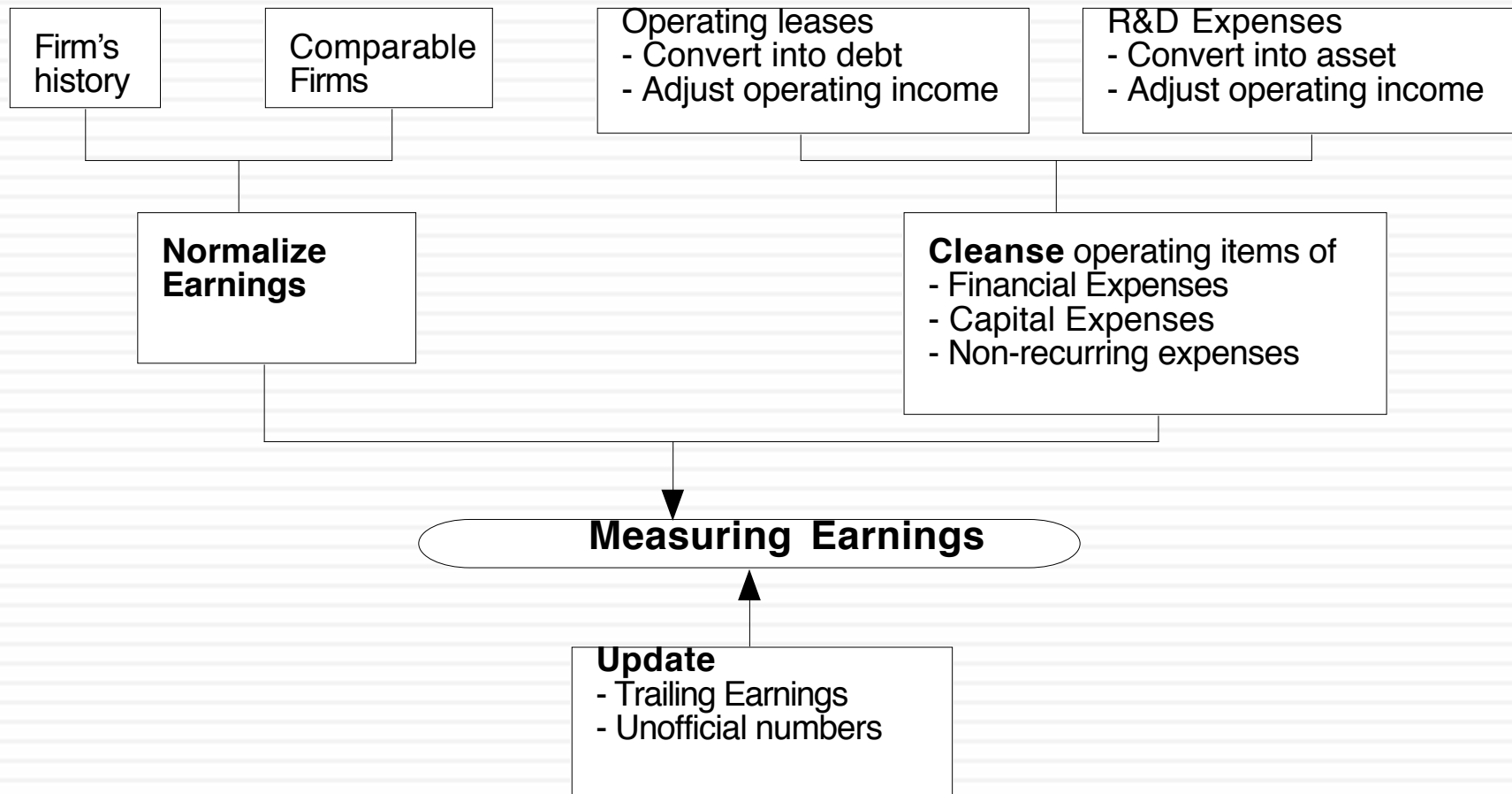

Operating Leases at Amgen in 2007

- Amgen has lease commitments and its cost of debt (based on its A rating) is 5.63%.

Year	Commitment	Present Value
1	\$96.00	\$90.88
2	\$95.00	\$85.14
3	\$102.00	\$86.54
4	\$98.00	\$78.72
5	\$87.00	\$66.16
6-12	\$107.43	\$462.10 (\$752 million prorated)

- Debt Value of leases = \$869.55
- Debt outstanding at Amgen = \$7,402 + \$ 870 = \$8,272 million
- Adjusted Operating Income = Stated OI + Lease expense this year – Depreciation
= 5,071 m + 69 m - 870/12 = \$5,068 million (12 year life for assets)
- Approximate Operating income= stated OI + PV of Lease commitment * Pre-tax cost of debt
= \$5,071 m + 870 m (.0563) = \$ 5,120 million

Capitalizing R&D Expenses: Amgen

- R & D was assumed to have a 10-year life.

Year	R&D Expense	Unamortized portion	Amortization this year	
Current	3366.00	1.00	3366.00	
-1	2314.00	0.90	2082.60	\$231.40
-2	2028.00	0.80	1622.40	\$202.80
-3	1655.00	0.70	1158.50	\$165.50
-4	1117.00	0.60	670.20	\$111.70
-5	865.00	0.50	432.50	\$86.50
-6	845.00	0.40	338.00	\$84.50
-7	823.00	0.30	246.90	\$82.30
-8	663.00	0.20	132.60	\$66.30
-9	631.00	0.10	63.10	\$63.10
-10	558.00	0.00	0.00	\$55.80
Value of Research Asset =			\$10,112.80	\$1,149.90

- Adjusted Operating Income = \$5,120 + 3,366 - 1,150 = \$7,336 million

II. Get the big picture (not the accounting one) when it comes to cap ex and working capital

- Capital expenditures should include
 - ▣ Research and development expenses, once they have been re-categorized as capital expenses.
 - ▣ Acquisitions of other firms, whether paid for with cash or stock.
- Working capital should be defined not as the difference between current assets and current liabilities but as the difference between non-cash current assets and non-debt current liabilities.
- On both items, start with what the company did in the most recent year but do look at the company's history and at industry averages.

Amgen's Net Capital Expenditures

- The accounting net cap ex at Amgen is small:
 - ▣ Accounting Capital Expenditures = \$1,218 million
 - ▣ - Accounting Depreciation = \$ 963 million
 - ▣ Accounting Net Cap Ex = \$ 255 million
- We define capital expenditures broadly to include R&D and acquisitions:
 - ▣ Accounting Net Cap Ex = \$ 255 million
 - ▣ Net R&D Cap Ex = (3366-1150) = \$2,216 million
 - ▣ Acquisitions in 2006 = \$3,975 million
 - ▣ Total Net Capital Expenditures = \$ 6,443 million
- Acquisitions have been a volatile item. Amgen was quiet on the acquisition front in 2004 and 2005 and had a significant acquisition in 2003.

III. The government bond rate is not always the risk free rate

- When valuing Amgen in US dollars, the US\$ ten-year bond rate of 4.78% was used as the risk free rate. We assumed that the US treasury was default free.
- When valuing Tata Motors in Indian rupees in 2010, the Indian government bond rate of 8% was not default free. Using the Indian government's local currency rating of Ba2 yielded a default spread of 3% for India and a riskfree rate of 5% in Indian rupees.

$$\text{Risk free rate in Indian Rupees} = 8\% - 3\% = 5\%$$

- To value a Brazilian company in nominal Reais, you would need a risk free rate in \$R. The ten-year Brazilian government bond rate in \$R was 13.18% in January 2013. Given Brazil's local currency rating of Baa2, the default spread for Brazil is 1.90%.

$$\text{Risk free rate in \$R} = 13.18\% - 1.90\% = 11.28\%$$

Risk free rates will vary across currencies: January 2014

Risk free rate by Currency: January 2014

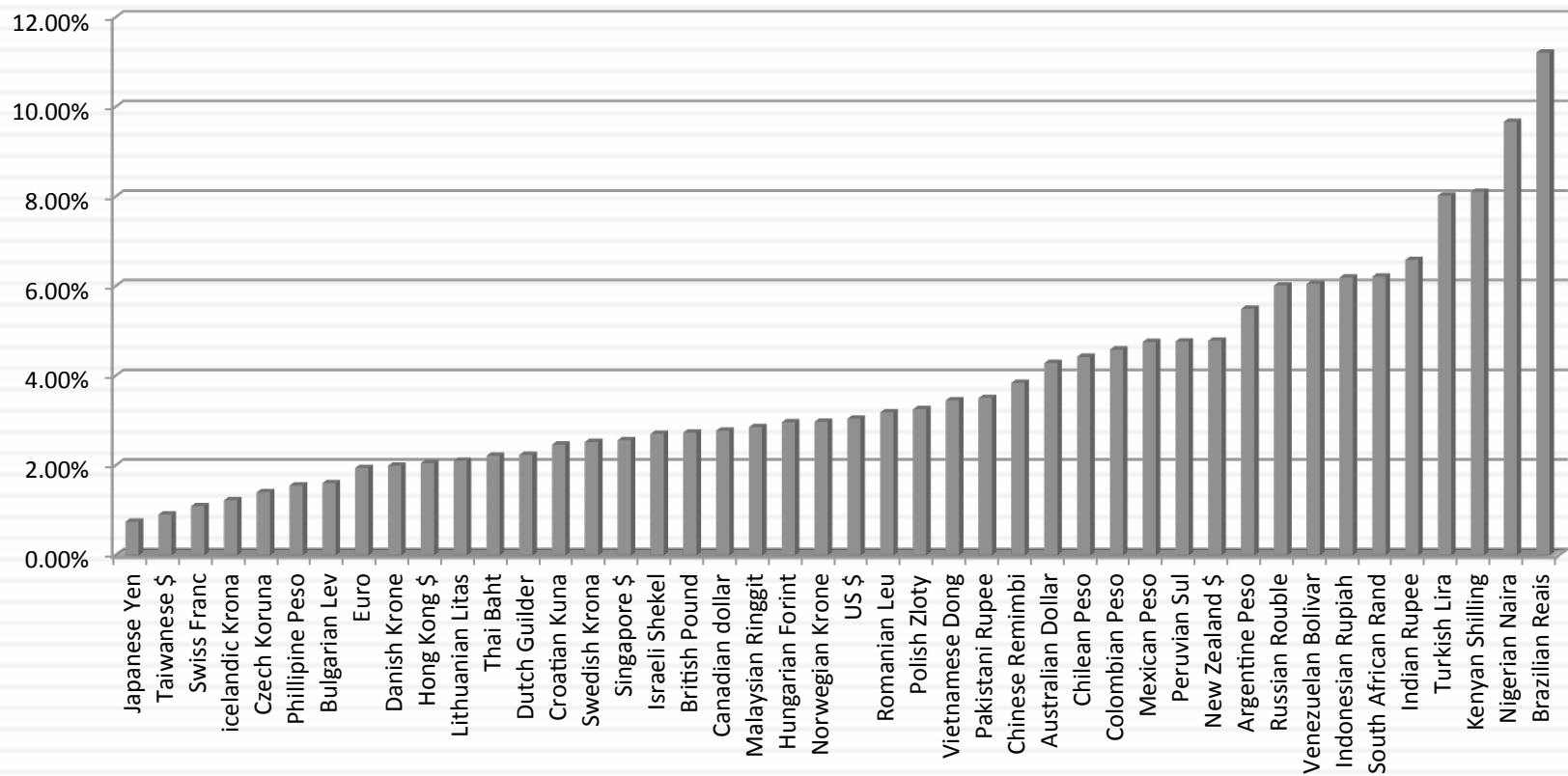

But valuations should not.. Tata Motors in US dollars

	In Indian Rupees	In US \$
Risk free Rate	5.00%	2.00%
Expected inflation rate	4.00%	1.00%
Cost of capital		
- High Growth	12.50%	9.25%
- Stable Growth	10.39%	7.21%
Expected growth rate		
- High Growth	12.01%	8.78%
- Stable Growth	5.00%	2.00%
Return on Capital		
- High Growth	17.16%	13.78%
- Stable Growth	10.39%	7.21%
Value per share	Rs 614	\$12.79/share (roughly Rs 614 at current exchange rate)

IV. Betas do not come from regressions... and are noisy...

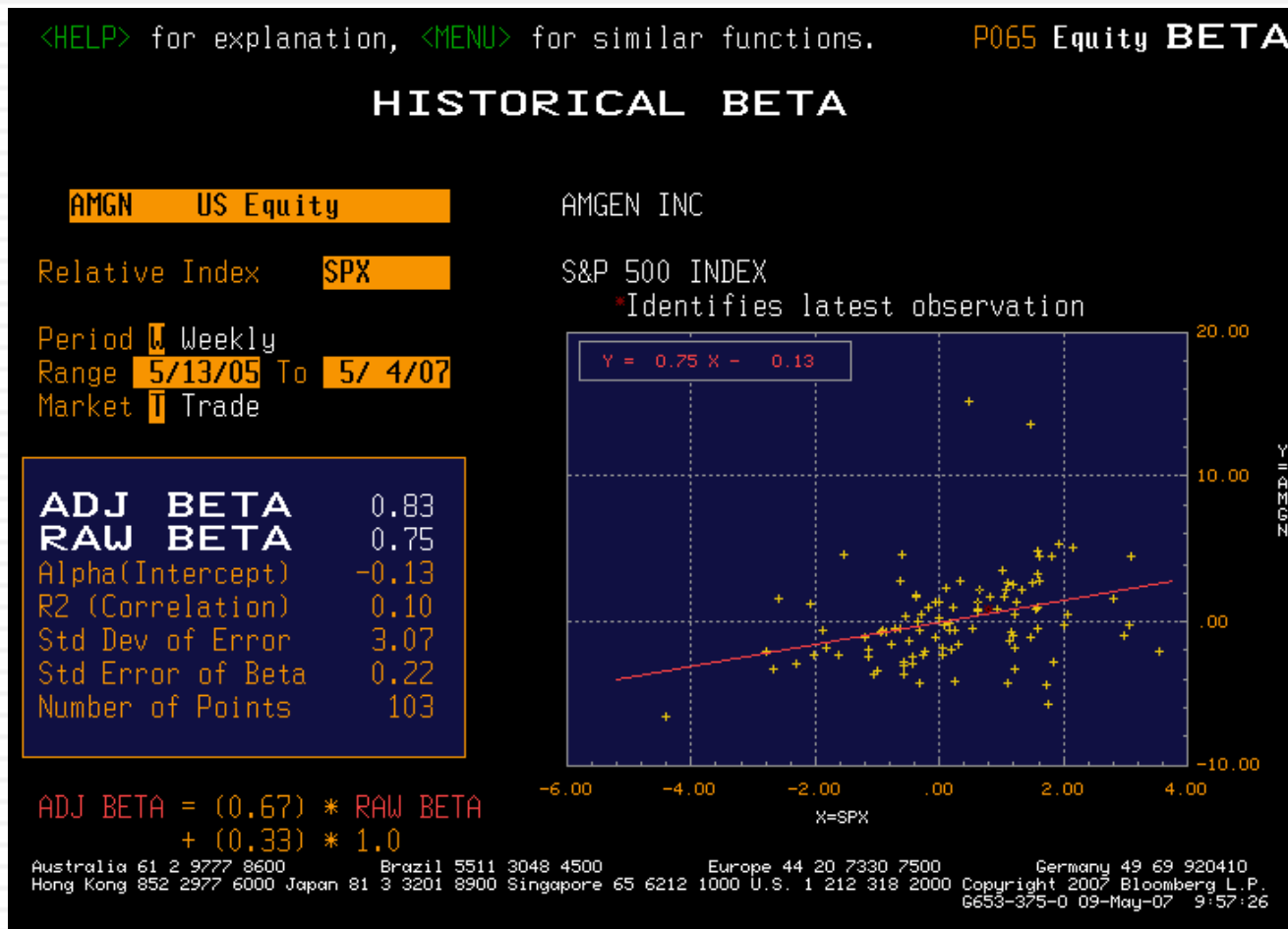

And can be a complete mess, when the market index is not a good one

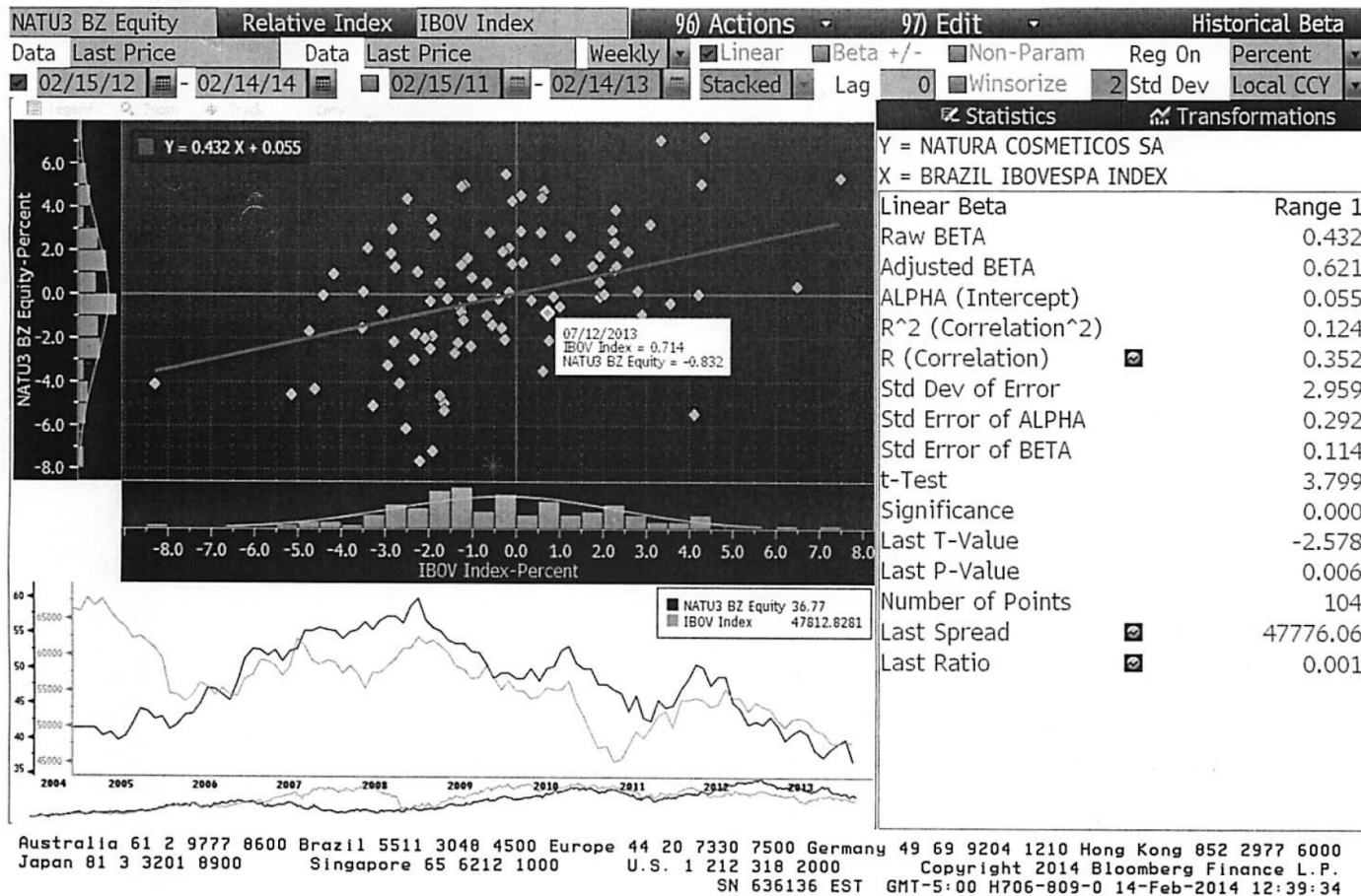

Determinants of Betas

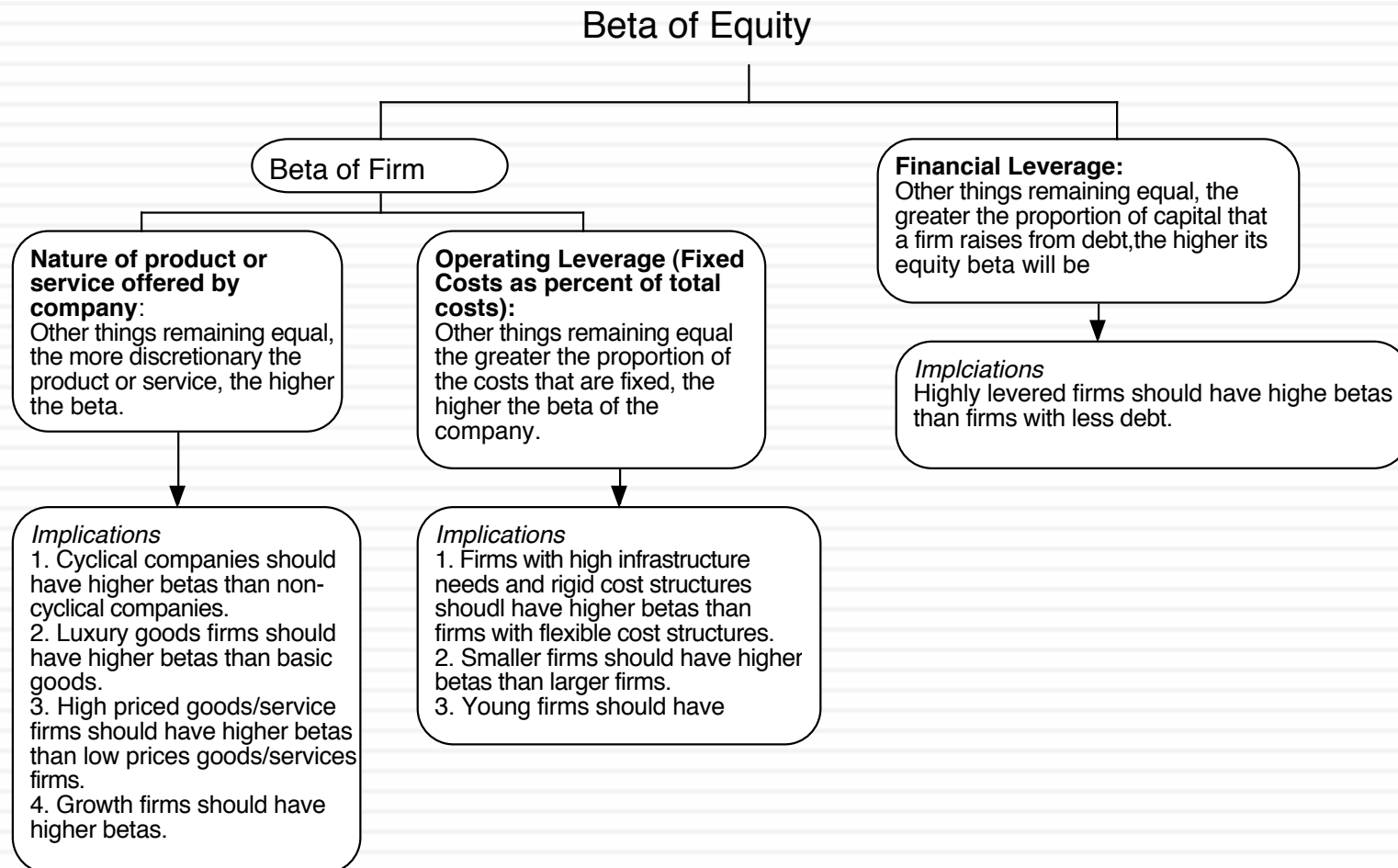

Bottom-up Betas

Step 1: Find the business or businesses that your firm operates in.

Step 2: Find publicly traded firms in each of these businesses and obtain their regression betas. Compute the simple average across these regression betas to arrive at an average beta for these publicly traded firms. Unlever this average beta using the average debt to equity ratio across the publicly traded firms in the sample.
Unlevered beta for business = Average beta across publicly traded firms / $(1 + (1-t) (\text{Average D/E ratio across firms}))$

Step 3: Estimate how much value your firm derives from each of the different businesses it is in.

Step 4: Compute a weighted average of the unlevered betas of the different businesses (from step 2) using the weights from step 3.
Bottom-up Unlevered beta for your firm = Weighted average of the unlevered betas of the individual business

Step 5: Compute a levered beta (equity beta) for your firm, using the market debt to equity ratio for your firm.
Levered bottom-up beta = Unlevered beta $(1 + (1-t) (\text{Debt/Equity}))$

Possible Refinements

If you can, adjust this beta for differences between your firm and the comparable firms on operating leverage and product characteristics.

While revenues or operating income are often used as weights, it is better to try to estimate the value of each business.

If you expect the business mix of your firm to change over time, you can change the weights on a year-to-year basis.

If you expect your debt to equity ratio to change over time, the levered beta will change over time.

Working through with our companies

□ Amgen in 2007

- The unlevered beta for pharmaceutical firms is 1.59. Using Amgen's debt to equity ratio of 11% and the marginal tax for the US in 2007 of 35%, the bottom up beta for Amgen is

- Bottom-up Beta = $1.59 (1 + (1 - .35)(.11)) = 1.73$

□ Tata Motors in 2010

- The unlevered beta for global automobile firms is 0.98. Using Tata Motor's debt to equity ratio of 33.87% and the marginal tax rate for India of 33.99%, the bottom up beta for Tata Motors is

- Bottom-up Beta = $0.98 (1 + (1 - .3399)(.3387)) = 1.20$

■ Natura in February 2014

- The unlevered beta for cosmetics companies is 0.97.

- The debt to equity ratio for Natura, based on market values for equity and debt, is 15.4% and the marginal tax rate for Brazil is 34.00%.

- Bottom-up Beta = $0.97 (1 + (1 - .34)(.154)) = 1.07$

V. And the past is not always a good indicator of the future

- It is standard practice to use historical premiums as forward looking premiums. :

	Arithmetic Average		Geometric Average	
	Stocks - T. Bills	Stocks - T. Bonds	Stocks - T. Bills	Stocks - T. Bonds
1928-2013	7.93%	6.29%	6.02%	4.62%
Std Error	2.19%	2.34%		
1964-2013	6.18%	4.32%	4.83%	3.33%
Std Error	2.42%	2.75%		
2004-2013	7.55%	4.41%	5.80%	3.07%
Std Error	6.02%	8.66%		

- Not only is this approach backward-looking, but it yields estimates which significant noise associated with them. The standard error in a historical estimate will be the following:

$$Standard\ Error_{Historical\ ERP} = \frac{Annual\ Standard\ Deviation_{Stocks}}{\sqrt{Number\ of\ years\ of\ data}}$$

- In most markets, you will be hard pressed to find more than a few decades of reliable stock market history, making historical risk premiums close to useless.

A forward-looking alternative: Back out an implied equity risk premium

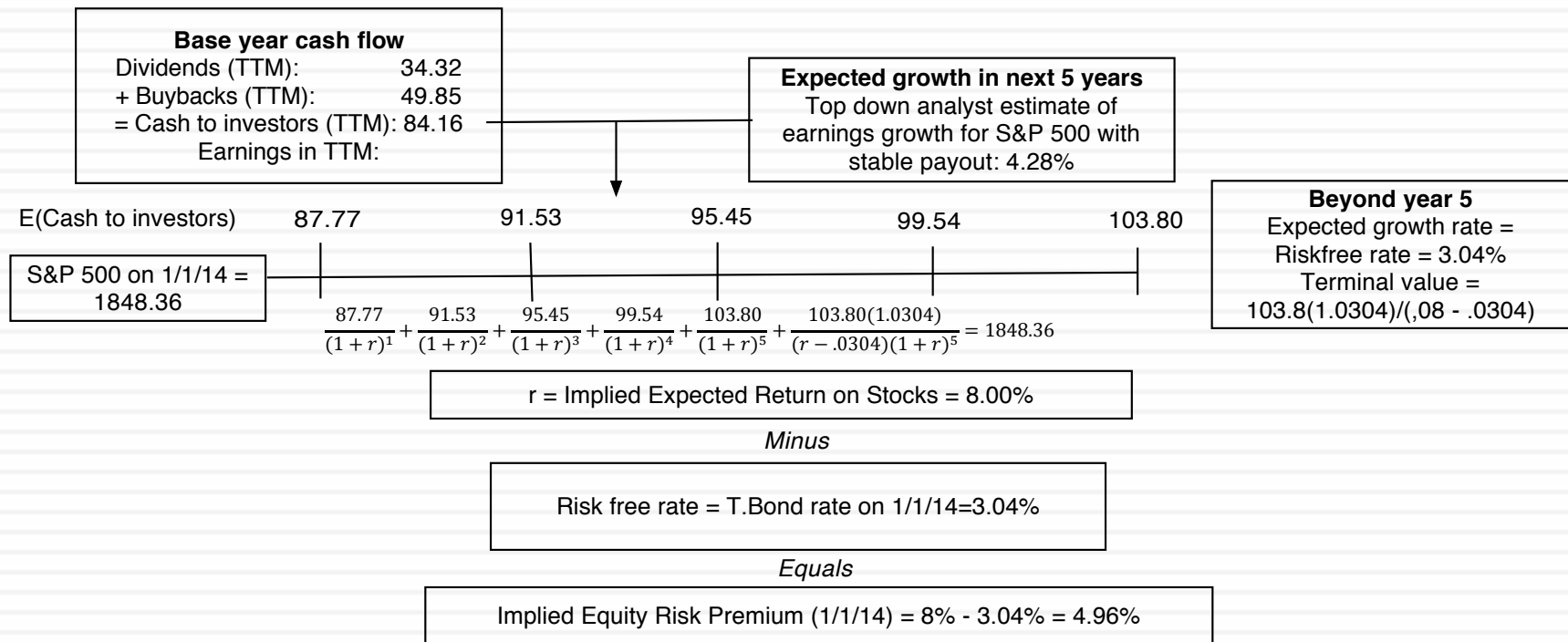

Implied Premiums in the US: 1960-2013

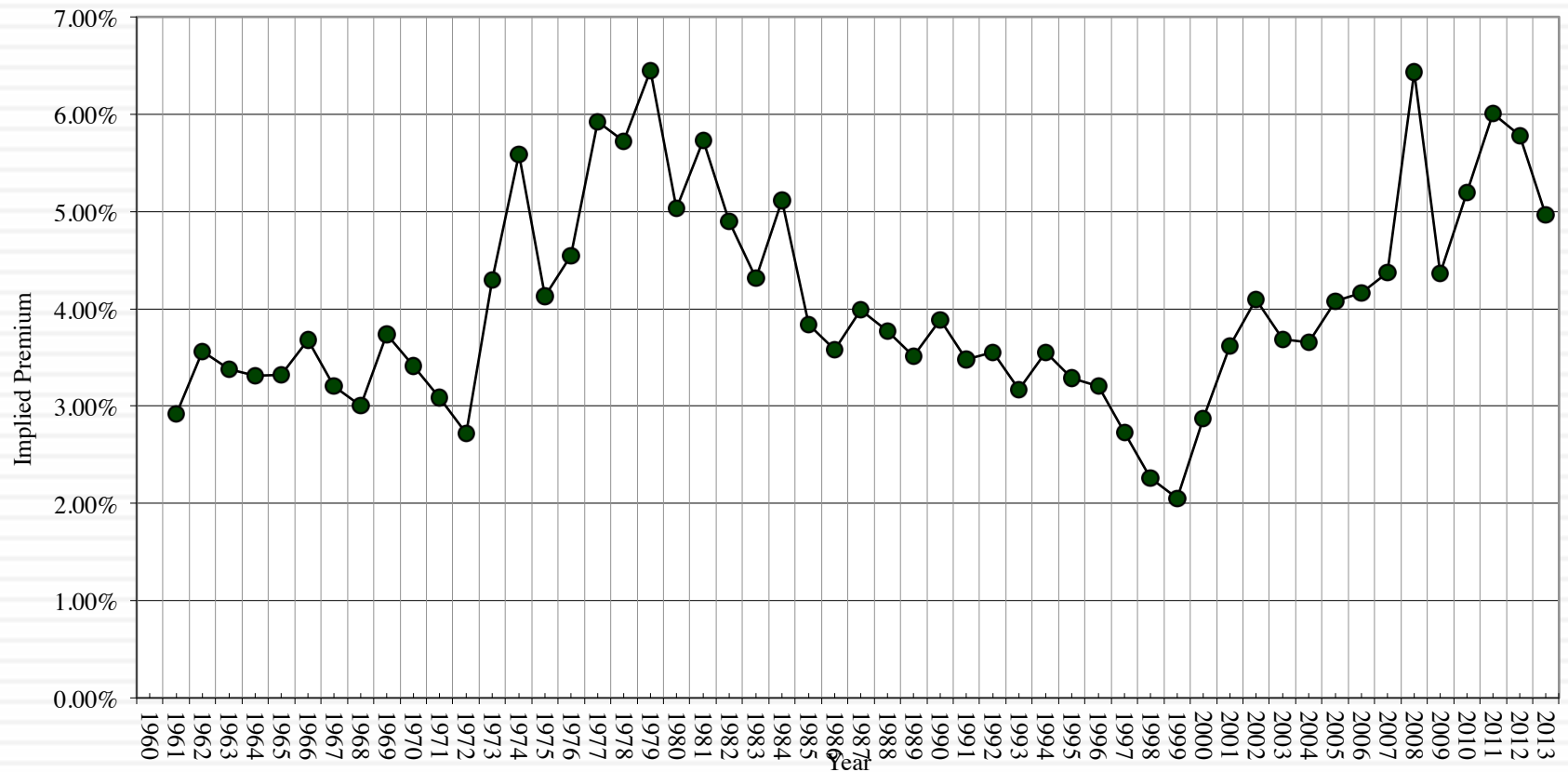

The Anatomy of a Crisis: Implied ERP from September 12, 2008 to January 1, 2009

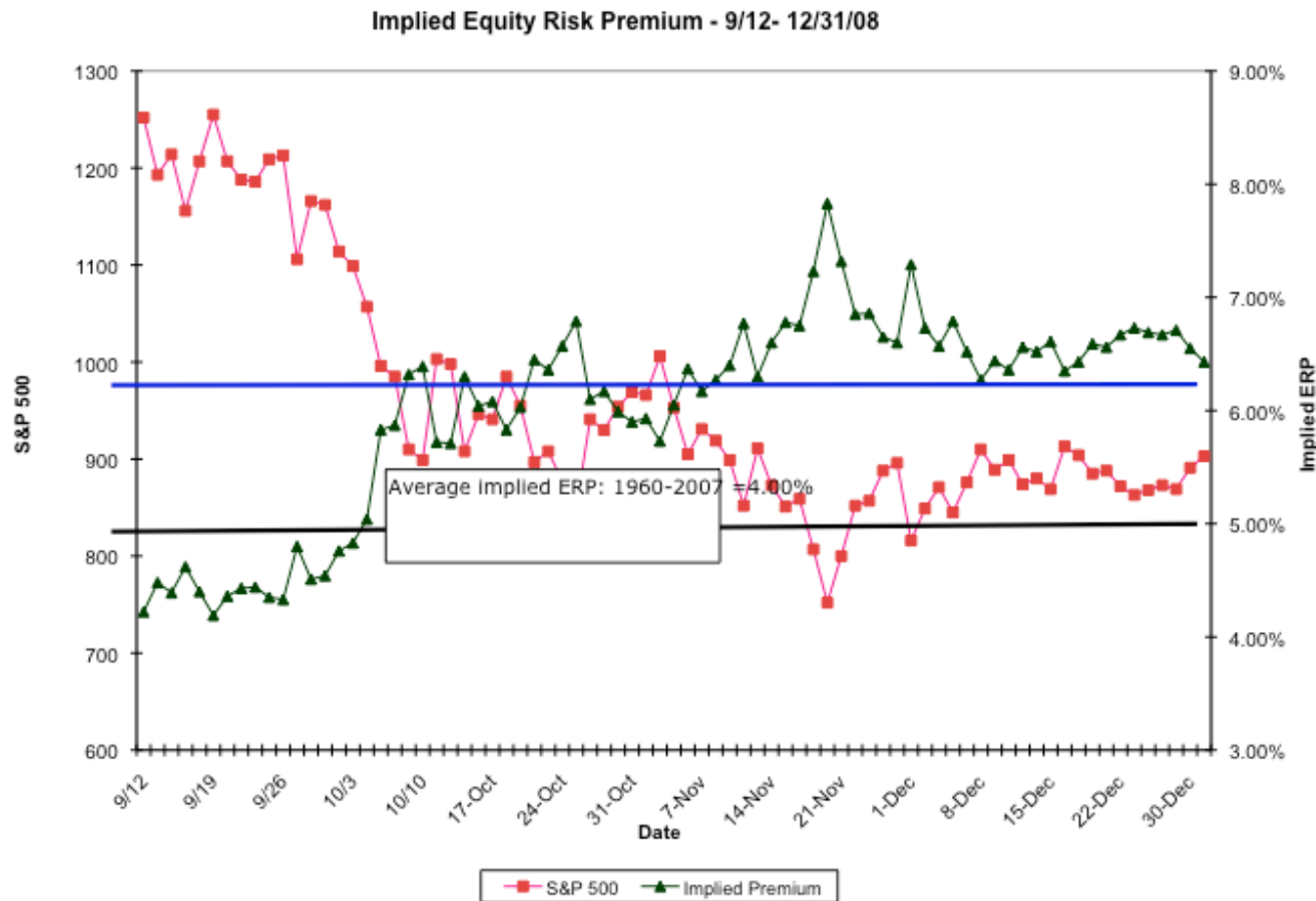

Implied ERP for Brazil versus US

Implied Equity Risk Premium - Brazil versus US

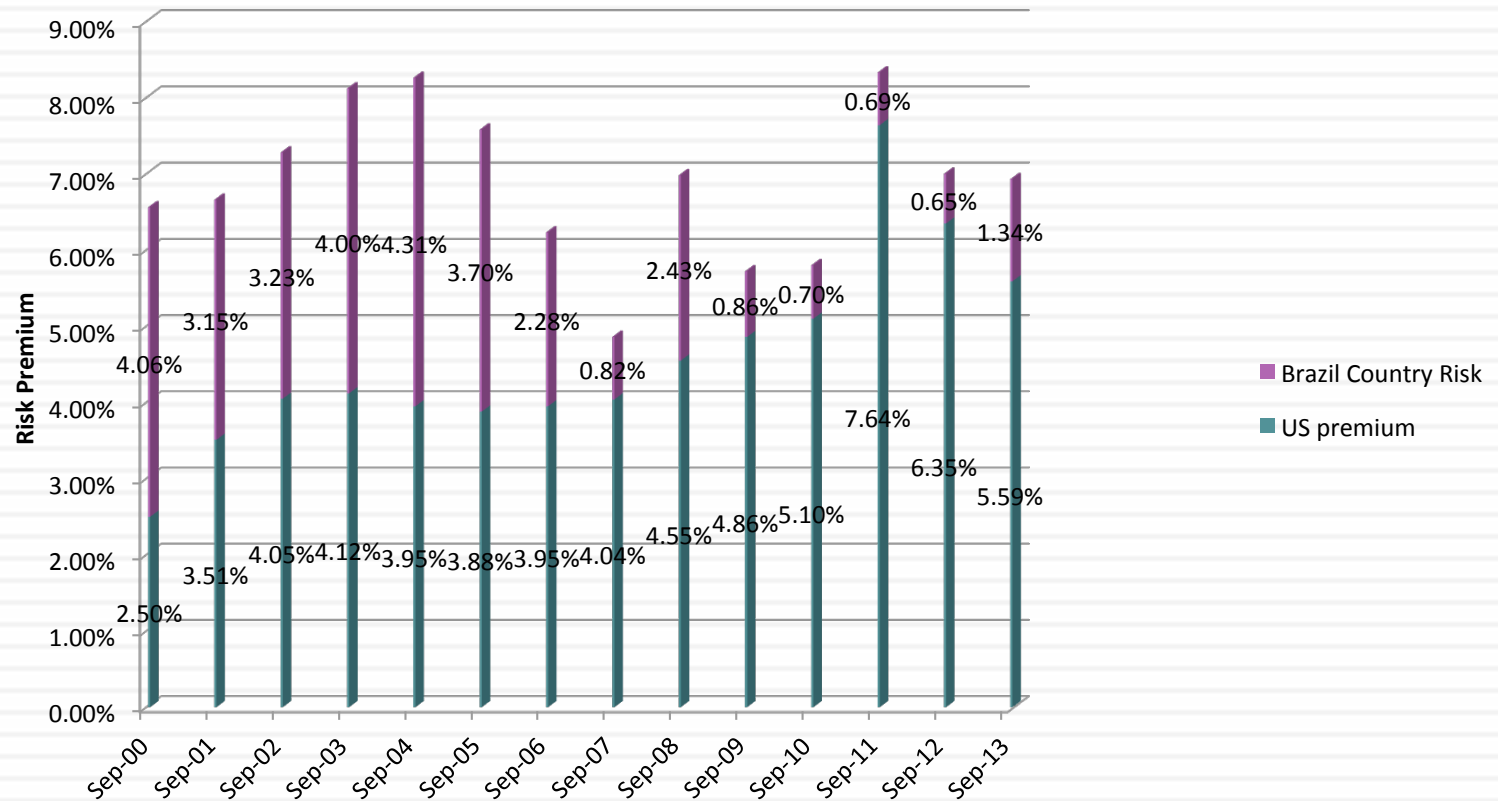

VI. There is a downside to globalization...

- Emerging markets offer growth opportunities but they are also riskier. If we want to count the growth, we have to also consider the risk.
- Two ways of estimating the country risk premium:
 - Sovereign Default Spread: In this approach, the country equity risk premium is set equal to the default spread of the bond issued by the country.
 - Equity Risk Premium for mature market = 4.50%
 - Default Spread for India = 3.00% (based on rating)
 - Equity Risk Premium for India = 4.50% + 3.00%
 - Adjusted for equity risk: The country equity risk premium is based upon the volatility of the equity market relative to the government bond rate.
 - Country risk premium = $\text{Default Spread} \times \frac{\text{Std Deviation}_{\text{Country Equity}}}{\text{Std Deviation}_{\text{Country Bond}}}$
 - Standard Deviation in Sensex = 21%
 - Standard Deviation in Indian government bond = 14%
 - Default spread on Indian Bond = 3%
 - Additional country risk premium for India = $3\% \times (21/14) = 4.5\%$

ERP : Jan 2014

Andorra	6.80%	1.80%	Liechtenstein	5.00%	0.00%
Austria	5.00%	0.00%	Luxembourg	5.00%	0.00%
Belgium	5.90%	0.90%	Malta	6.80%	1.80%
Cyprus	20.00%	15.00%	Netherlands	5.00%	0.00%
Denmark	5.00%	0.00%	Norway	5.00%	0.00%
Finland	5.00%	0.00%	Portugal	10.40%	5.40%
France	5.60%	0.60%	Spain	8.30%	3.30%
Germany	5.00%	0.00%	Sweden	5.00%	0.00%
Greece	20.00%	15.00%	Switzerland	5.00%	0.00%
Iceland	8.30%	3.30%	Turkey	8.30%	3.30%
Ireland	8.75%	3.75%	United Kingdom	5.60%	0.60%
Italy	7.85%	2.85%	Western Europe	6.29%	1.29%

Canada	5.00%	0.00%
United States of America	5.00%	0.00%
North America	5.00%	0.00%

Argentina	14.75%	9.75%
Belize	18.50%	13.50%
Bolivia	10.40%	5.40%
Brazil	7.85%	2.85%
Chile	5.90%	0.90%
Colombia	8.30%	3.30%
Costa Rica	8.30%	3.30%
Ecuador	16.25%	11.25%
El Salvador	10.40%	5.40%
Guatemala	8.75%	3.75%
Honduras	13.25%	8.25%
Mexico	7.40%	2.40%
Nicaragua	14.75%	9.75%
Panama	7.85%	2.85%
Paraguay	10.40%	5.40%
Peru	7.85%	2.85%
Suriname	10.40%	5.40%
Uruguay	8.30%	3.30%
Venezuela	16.25%	11.25%
Latin America	8.62%	3.62%

Angola	10.40%	5.40%
Benin	13.25%	8.25%
Botswana	6.28%	1.28%
Burkina Faso	13.25%	8.25%
Cameroon	13.25%	8.25%
Cape Verde	13.25%	8.25%
DR Congo	14.75%	9.75%
Egypt	16.25%	11.25%
Gabon	10.40%	5.40%
Ghana	11.75%	6.75%
Kenya	11.75%	6.75%
Morocco	8.75%	3.75%
Mozambique	11.75%	6.75%
Namibia	8.30%	3.30%
Nigeria	10.40%	5.40%
Rep Congo	10.40%	5.40%
Rwanda	13.25%	8.25%
Senegal	11.75%	6.75%
South Africa	7.40%	2.40%
Tunisia	10.40%	5.40%
Uganda	11.75%	6.75%
Zambia	11.75%	6.75%
Africa	10.04%	5.04%

Albania	11.75%	6.75%
Armenia	9.50%	4.50%
Azerbaijan	8.30%	3.30%
Belarus	14.75%	9.75%
Bosnia and Herzegovina	14.75%	9.75%
Bulgaria	7.85%	2.85%
Croatia	8.75%	3.75%
Czech Republic	6.05%	1.05%
Estonia	6.05%	1.05%
Georgia	10.40%	5.40%
Hungary	8.75%	3.75%
Kazakhstan	7.85%	2.85%
Latvia	7.85%	2.85%
Lithuania	7.40%	2.40%
Macedonia	10.40%	5.40%
Moldova	14.75%	9.75%
Montenegro	10.40%	5.40%
Poland	6.28%	1.28%
Romania	8.30%	3.30%
Russia	7.40%	2.40%
Serbia	11.75%	6.75%
Slovakia	6.28%	1.28%
Slovenia	8.75%	3.75%
Ukraine	16.25%	11.25%
E. Europe & Russia	7.96%	2.96%

Abu Dhabi	5.75%	0.75%
Bahrain	7.85%	2.85%
Israel	6.05%	1.05%
Jordan	11.75%	6.75%
Kuwait	5.75%	0.75%
Lebanon	11.75%	6.75%
Oman	6.05%	1.05%
Qatar	5.75%	0.75%
Saudi Arabia	5.90%	0.90%
United Arab Emirates	5.75%	0.75%
Middle East	6.14%	1.14%

Bangladesh	10.40%	5.40%
Cambodia	13.25%	8.25%
China	5.90%	0.90%
Fiji	11.75%	6.75%
Hong Kong	5.60%	0.60%
India	8.30%	3.30%
Indonesia	8.30%	3.30%
Japan	5.90%	0.90%
Korea	5.90%	0.90%
Macao	5.90%	0.90%
Malaysia	6.80%	1.80%
Mauritius	7.40%	2.40%
Mongolia	11.75%	6.75%
Pakistan	16.25%	11.25%
Papua New Guinea	11.75%	6.75%
Philippines	8.30%	3.30%
Singapore	5.00%	0.00%
Sri Lanka	11.75%	6.75%
Taiwan	5.90%	0.90%
Thailand	7.40%	2.40%
Vietnam	13.25%	8.25%
Asia	6.51%	1.51%

Australia	5.00%	0.00%
Cook Islands	11.75%	6.75%
New Zealand	5.00%	0.00%
Australia & New Zealand	5.00%	0.00%

Black #: Total ERP
 Red #: Country risk premium
 AVG: GDP weighted average

VII. And it is not just emerging market companies that are exposed to this risk..

- The “default” approach in valuation has been to assign country risk based upon your country of incorporation. Thus, if you are incorporated in a developed market, the assumption has been that you are not exposed to emerging market risks. If you are incorporated in an emerging market, you are saddled with the entire country risk.
- As companies globalize and look for revenues in foreign markets, this practice will under estimate the costs of equity of developed market companies with significant emerging market risk exposure and over estimate the costs of equity of emerging market companies with significant developed market risk exposure.

Globalization's flip side: Operation-based ERP

Coca Cola (2011)

<i>Region</i>	<i>Revenues</i>	<i>Total ERP</i>	<i>CRP</i>
Western Europe	19%	6.67%	0.67%
Eastern Europe & Russia	5%	8.60%	2.60%
Asia	15%	7.63%	1.63%
Latin America	15%	9.42%	3.42%
Australia	4%	6.00%	0.00%
Africa	4%	9.82%	3.82%
North America	40%	6.00%	0.00%
Coca Cola	100%	7.14%	1.14%

Natura (2013)

Brazil	88.72%	7.85%	88.72%
Argentina	2.57%	14.75%	2.57%
Chile	2.57%	5.90%	2.57%
Peru	2.57%	7.85%	2.57%
Mexico	1.79%	7.40%	1.79%
Colombia	1.79%	8.30%	1.79%
Natura	100.00%	7.98%	100.00%

Vale (2013)

	<i>% Revenues</i>	<i>ERP</i>
US & Canada	4.90%	5.50%
Brazil	16.90%	8.50%
Rest of Latin America	1.70%	10.09%
China	37.00%	6.94%
Japan	10.30%	6.70%
Rest of Asia	8.50%	8.61%
Europe	17.20%	6.72%
Rest of World	3.50%	10.06%
Company	100.00%	7.38%

An alternate approach: Estimate a “country risk exposure factor (lambda)”

	<i>Tata Motors</i>	<i>TCS</i>
% of production/operations in India	High	High
% of revenues in India	91.37% (in 2009) Estimated 70% (in 2010)	7.62%
Lambda	0.80	0.20
Flexibility in moving operations	Low. Significant physical assets.	High. Human capital is mobile.

VIII. Growth has to be earned (not endowed or estimated): Measuring Investment Quality

Adjust EBIT for

- a. Extraordinary or one-time expenses or income
- b. Operating leases and R&D
- c. Cyclicalities in earnings (Normalize)
- d. Acquisition Debris (Goodwill amortization etc.)

Use a marginal tax rate to be safe. A high ROC created by paying low effective taxes is not sustainable

$$\text{ROC} = \frac{\text{EBIT} (1 - \text{tax rate})}{\text{Book Value of Equity} + \text{Book value of debt} - \text{Cash}}$$

Adjust book equity for

- 1. Capitalized R&D
- 2. Acquisition Debris (Goodwill)

Adjust book value of debt for

- a. Capitalized operating leases

Use end of prior year numbers or average over the year but be consistent in your application

The Quality of Growth – A Global Perspective

ROIC versus Cost of Capital: A Global Assessment for 2013

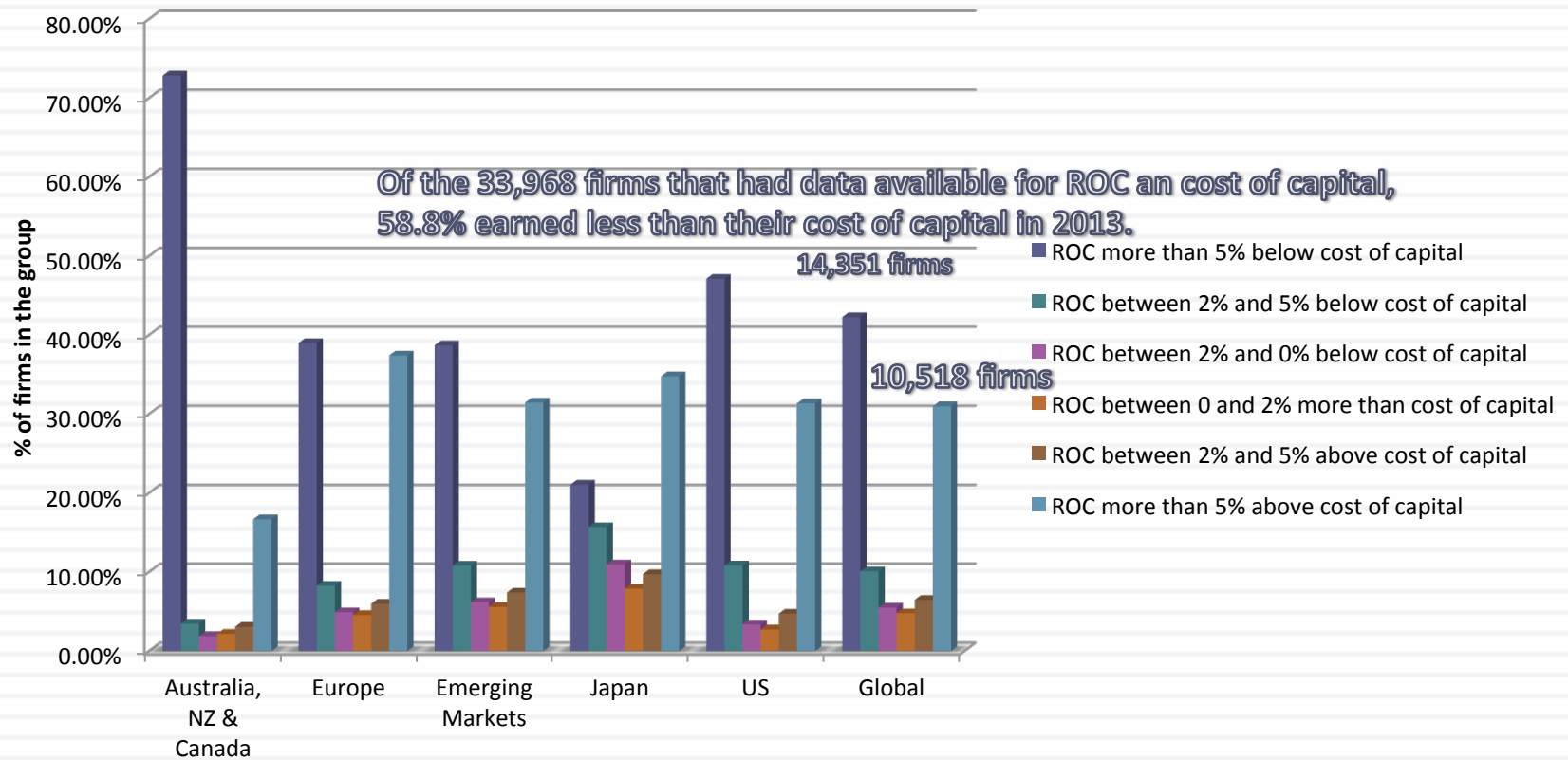

IX. All good things come to an end..And the terminal value is not an ATM...

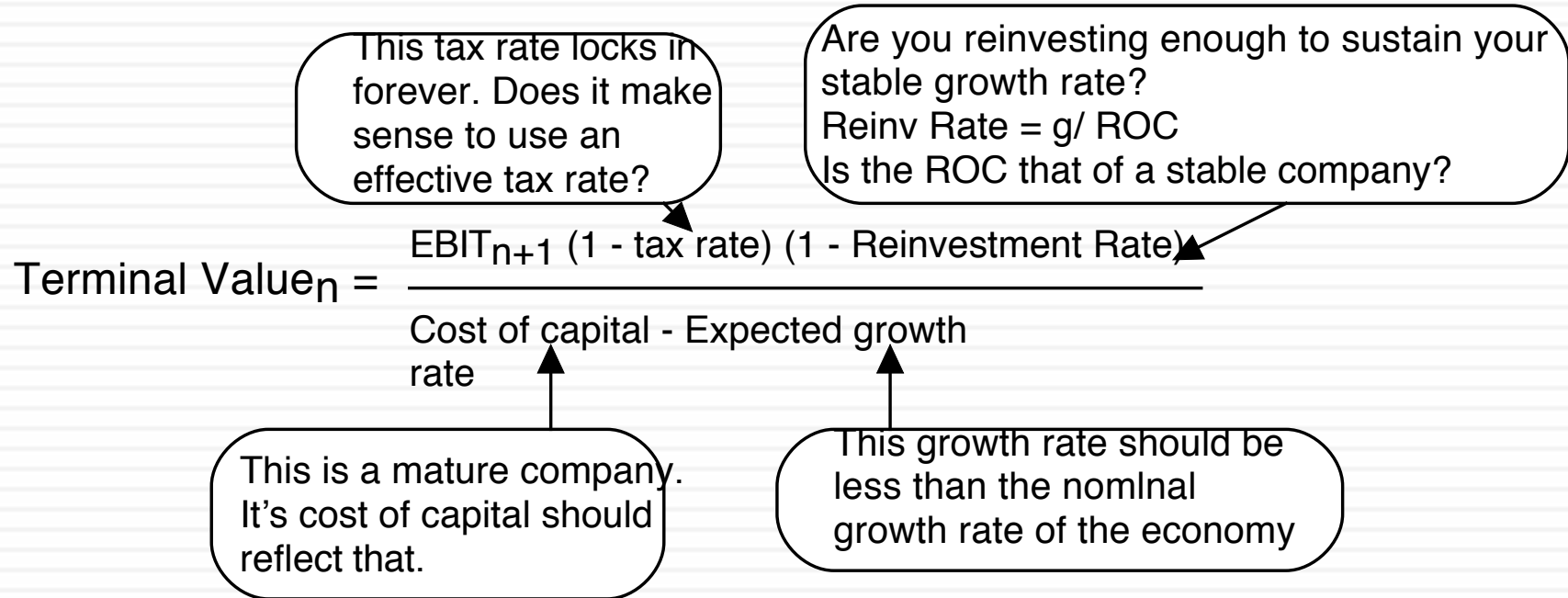

Terminal Value and Growth

<i>Stable growth rate</i>	<i>Amgen</i>	<i>Tata Motors</i>	<i>Stable growth rate</i>	<i>Natura</i>
0%	\$150,652	435,686₹	0%	R\$ 21,709
1%	\$154,479	435,686₹	2%	R\$ 24,473
2%	\$160,194	435,686₹	4%	R\$ 27,989
3%	\$167,784	435,686₹	6%	R\$ 32,538
4%	\$179,099	435,686₹	8%	R\$ 38,815
5%		435,686₹	10%	R\$ 48,394
Riskfree rate	4.78%	5%		11.28%
ROIC	10%	10.39%		25.00%
Cost of capital	8.08%	10.39%		16.35%

Aswath Damodaran



THE LOOSE ENDS IN VALUATION...

Aswath Damodaran

Getting from DCF to value per share: The Loose Ends

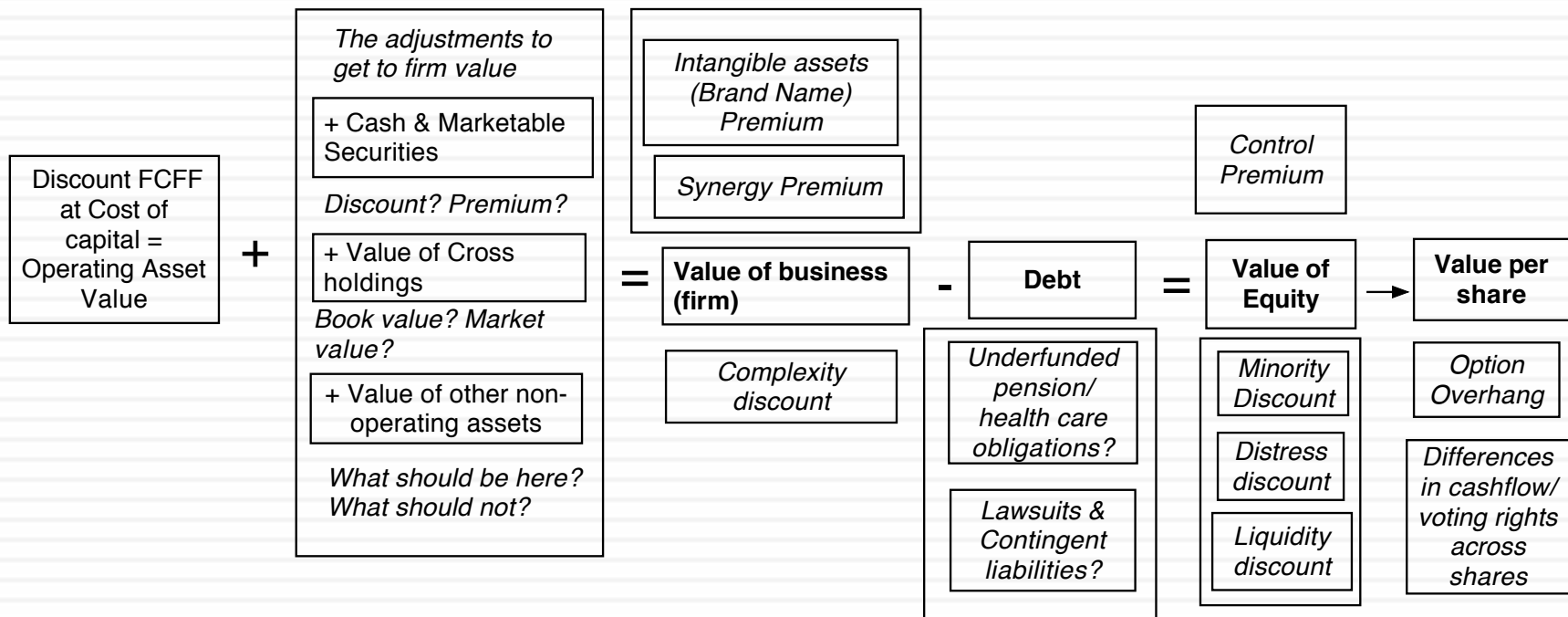

1. The Value of Cash

An Exercise in Cash Valuation

	Company A	Company B	Company C
Enterprise Value	\$ 1 billion	\$ 1 billion	\$ 1 billion
Cash	\$ 100 mil	\$ 100 mil	\$ 100 mil
Return on Capital	10%	5%	22%
Cost of Capital	10%	10%	12%
Trades in	US	US	Argentina

- In which of these companies is cash most likely to trade at face value, at a discount and at a premium?

Cash: Discount or Premium?

*Market Value of \$ 1 in cash:
Estimates obtained by regressing Enterprise Value against Cash Balances*

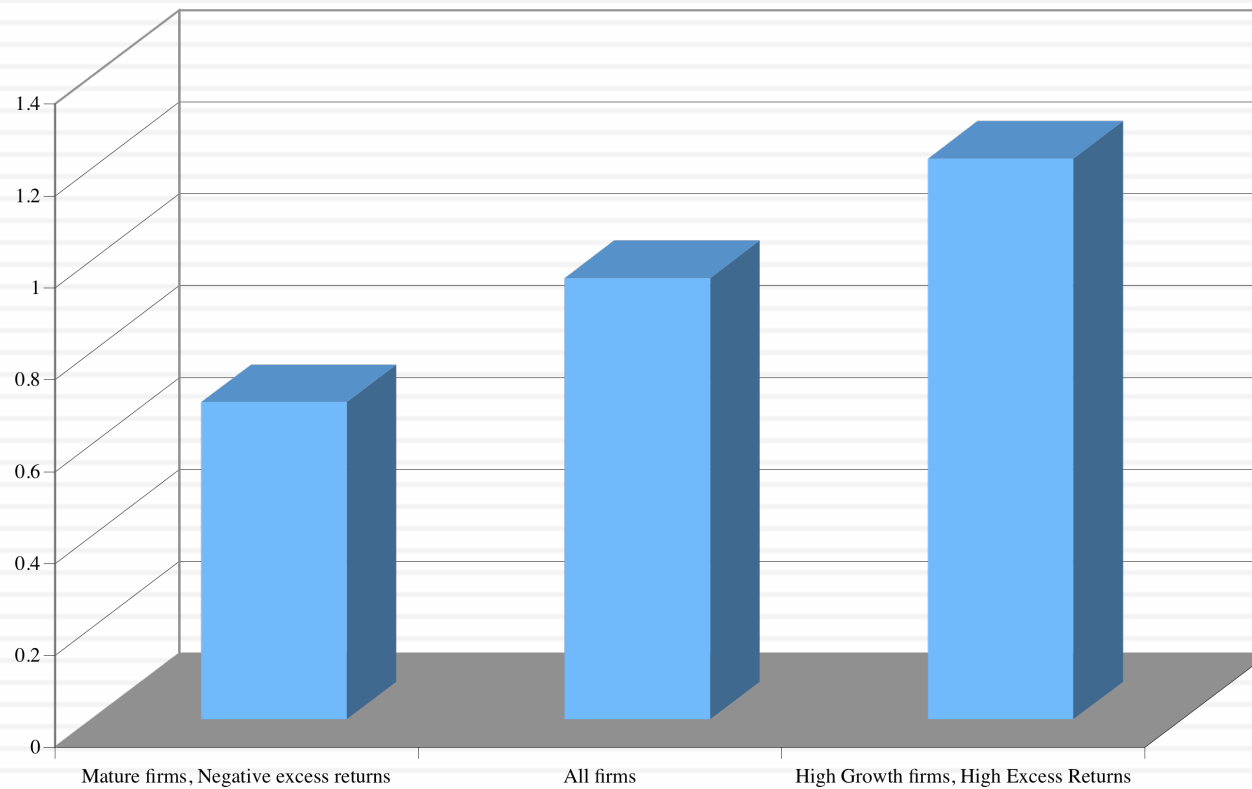

2. Dealing with Holdings in Other firms

- Holdings in other firms can be categorized into
 - ▣ Minority passive holdings, in which case only the dividend from the holdings is shown in the balance sheet
 - ▣ Minority active holdings, in which case the share of equity income is shown in the income statements
 - ▣ Majority active holdings, in which case the financial statements are consolidated.
- We tend to be sloppy in practice in dealing with cross holdings. After valuing the operating assets of a firm, using consolidated statements, it is common to add on the balance sheet value of minority holdings (which are in book value terms) and subtract out the minority interests (again in book value terms), representing the portion of the consolidated company that does not belong to the parent company.

How to value holdings in other firms.. In a perfect world..

- In a perfect world, we would strip the parent company from its subsidiaries and value each one separately. The value of the combined firm will be
 - ▣ Value of parent company + Proportion of value of each subsidiary
- To do this right, you will need to be provided detailed information on each subsidiary to estimate cash flows and discount rates.

Valuing Yahoo as the sum of its intrinsic pieces

47

100% of Yahoo! US Equity	+ 35% of Yahoo! Japan Equity	+ 22.1% of Alibaba Equity	- Loose Ends =	Equity value= \$41,571 Per share = \$41.19
Operating assets = \$4383	Operating assets = \$17,884	Operating assets = \$127,484	- Taxes due = \$5,017	
+ Cash = \$4,571	+ Cash = \$3,113	+ Cash = \$27,963	- Yahoo options = \$298	
- Debt = \$1,591	- Debt = \$0	- Debt = \$6,670		
=Parent Equity = \$7,363	Equity = \$20,997 35% of value = \$7,349	Equity = \$145,587 22.1% of value = \$32,175		

Two compromise solutions...

- The market value solution: When the subsidiaries are publicly traded, you could use their traded market capitalizations to estimate the values of the cross holdings. You do risk carrying into your valuation any mistakes that the market may be making in valuation.
- The relative value solution: When there are too many cross holdings to value separately or when there is insufficient information provided on cross holdings, you can convert the book values of holdings that you have on the balance sheet (for both minority holdings and minority interests in majority holdings) by using the average price to book value ratio of the sector in which the subsidiaries operate.

Yahoo: A pricing game?

49

<i>Item</i>	<i>Computation details</i>	<i>Estimated value</i>
Market Capitalization of Yahoo!	\$33.76*1009.39 million	\$34,077
- 35% of Market Cap of Yahoo! Japan	.35 (\$24,393 million)	\$8,538
- 22.1% of Equity value in Alibaba (estimate)	.221(\$150,000 million)	\$33,165
+ Taxes Due on Alibaba share sale	40% of capital gains	\$5,232
+ Yahoo Debt	From 2013 10K	\$1,228
- Yahoo Cash	From 2013 10K	\$4,998
+ Yahoo equity options	From Yahoo valuation	\$388
Imputed value for Yahoo Parent operating assets		-\$5,776
Intrinsic value (my estimate) of Yahoo! Parent		\$5,474
Relative value (my estimate) of Yahoo! Parent		\$5,289

Tata Motor's Cross Holdings

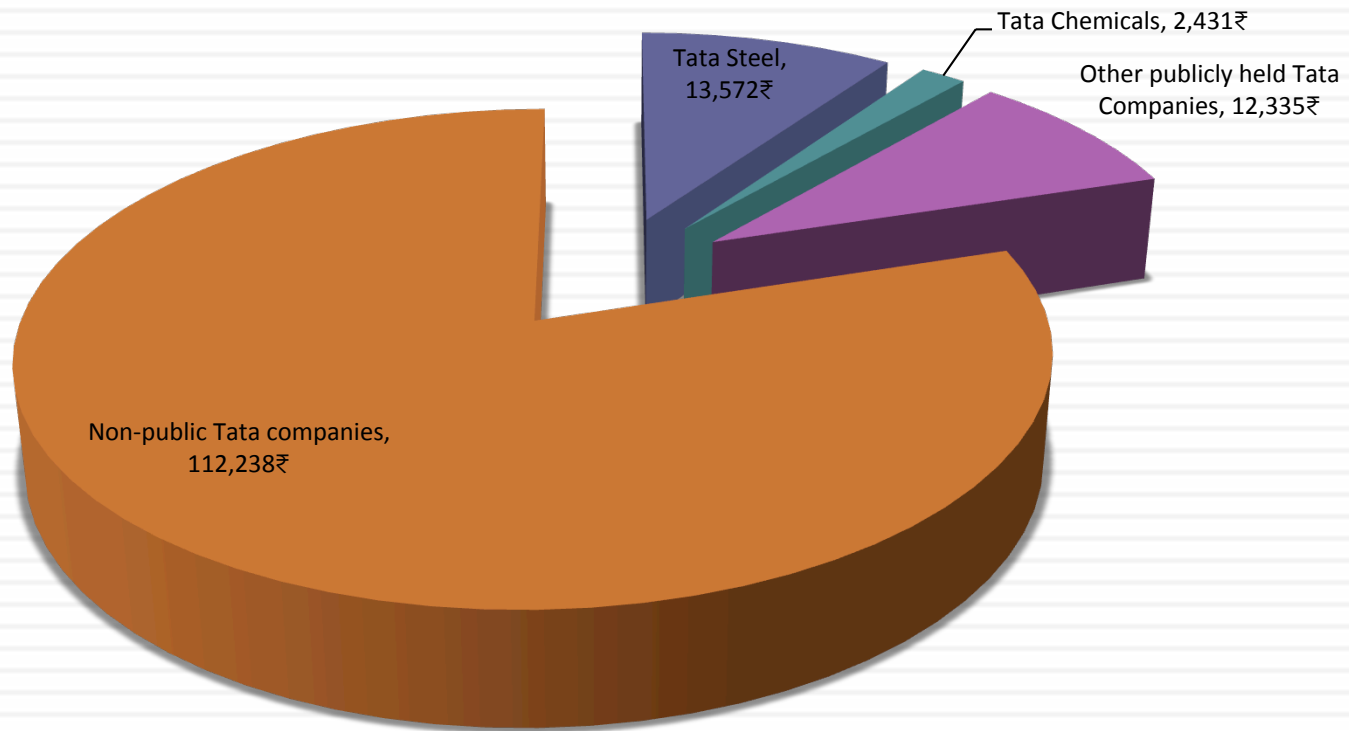

3. Other Assets that have not been counted yet..

- Unutilized assets: If you have assets or property that are not being utilized (vacant land, for example), you have not valued it yet. You can assess a market value for these assets and add them on to the value of the firm.
- Overfunded pension plans: If you have a defined benefit plan and your assets exceed your expected liabilities, you could consider the over funding with two caveats:
 - Collective bargaining agreements may prevent you from laying claim to these excess assets.
 - There are tax consequences. Often, withdrawals from pension plans get taxed at much higher rates.
- **Do not double count an asset.** If you count the income from an asset in your cash flows, you cannot count the market value of the asset in your value.

4. Brand name, great management, superb product ...Don't double count!

- There is often a temptation to add on premiums for intangibles. Here are a few examples.
 - ▣ Brand name
 - ▣ Great management
 - ▣ Loyal workforce
 - ▣ Technological prowess
- There are two potential dangers:
 - ▣ For some assets, the value may already be in your value and adding a premium will be double counting.
 - ▣ For other assets, the value may be ignored but incorporating it will not be easy.

Valuing Brand Name

	Coca Cola	With Cott Margins
Current Revenues =	\$21,962.00	\$21,962.00
Length of high-growth period	10	10
Reinvestment Rate =	50%	50%
Operating Margin (after-tax)	15.57%	5.28%
Sales/Capital (Turnover ratio)	1.34	1.34
Return on capital (after-tax)	20.84%	7.06%
Growth rate during period (g) =	10.42%	3.53%
Cost of Capital during period =	7.65%	7.65%
Stable Growth Period		
Growth rate in steady state =	4.00%	4.00%
Return on capital =	7.65%	7.65%
Reinvestment Rate =	52.28%	52.28%
Cost of Capital =	7.65%	7.65%
Value of Firm =	\$79,611.25	\$15,371.24

5. The Value of Control: It's not always worth 20%!!

- The value of the control premium that will be paid to acquire a block of equity will depend upon two factors -
 - Probability that control of firm will change: This refers to the probability that incumbent management will be replaced. this can be either through acquisition or through existing stockholders exercising their muscle.
 - Value of Gaining Control of the Company: The value of gaining control of a company arises from two sources - the increase in value that can be wrought by changes in the way the company is managed and run, and the side benefits and perquisites of being in control
 - Value of Gaining Control = Present Value (Value of Company with change in control - Value of company without change in control) + Side Benefits of Control

Increase Cash Flows

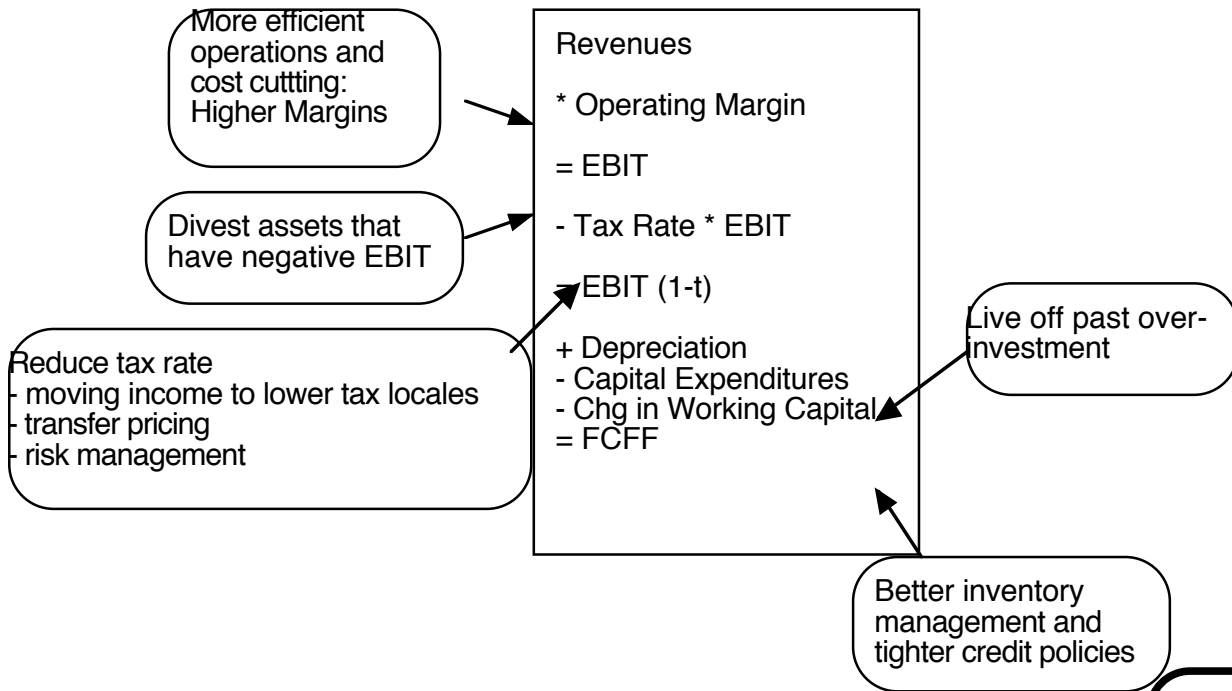

Reduce the cost of capital

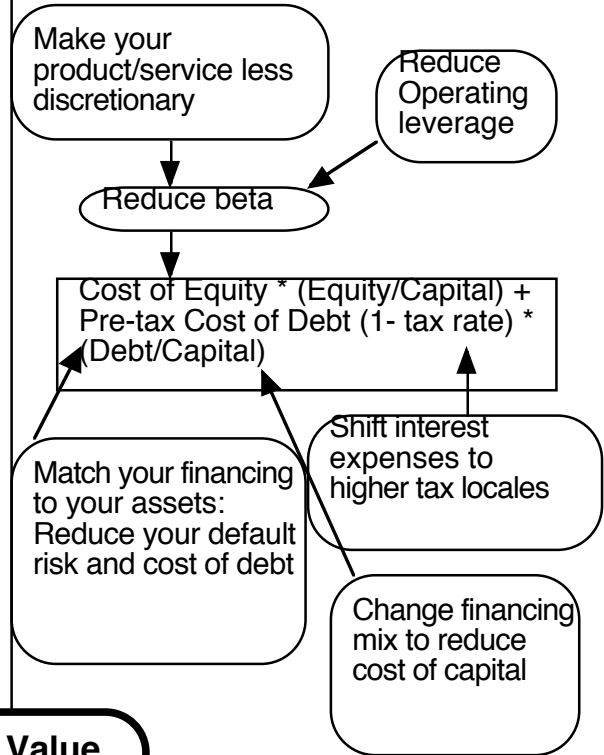

Firm Value

Increase Expected Growth

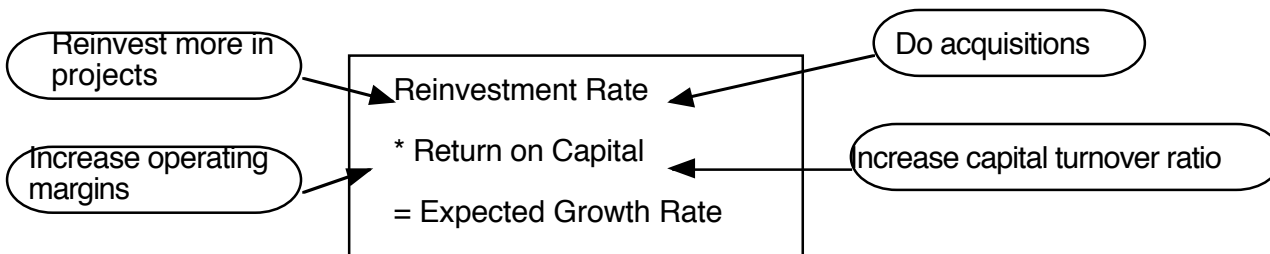

Increase length of growth period

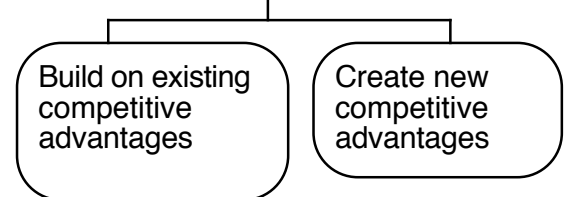

Adris Grupa (Status Quo): 4/2010

Current Cashflow to Firm
 EBIT(1-t) : 436 HRK
 - Nt CpX 3 HRK
 - Chg WC -118 HRK
 = FCFF 551 HRK
 Reinv Rate = $(3-118)/436 = -26.35\%$;
 Tax rate = 17.35%
 Return on capital = 8.72%

Average from 2004-09
70.83%

Reinvestment Rate
70.83%

Expected Growth from new inv.
 $.7083 \cdot .0969 = 0.0686$
 or 6.86%

Average from 2004-09
9.69%

Return on Capital
9.69%

Stable Growth
 $g = 4\%$; Beta = 0.80
 Country Premium = 2%
 Cost of capital = 9.92%
 Tax rate = 20.00%
 ROC = 9.92%;
 Reinvestment Rate = $g/ROC = 4/9.92 = 40.32\%$

Terminal Value₅ = $365 / (.0992 - .04) = 6170$ HRK

Op. Assets 4312
 + Cash: 1787
 - Debt 141
 - Minority int 465
 = Equity 5,484
 / (Common + Preferred shares)
 Value non-voting share 335 HRK/share

Year	1	2	3	4	5	
EBIT (1-t)	HRK 466	HRK 498	HRK 532	HRK 569	HRK 608	612 246 365
- Reinvestment	HRK 330	HRK 353	HRK 377	HRK 403	HRK 431	
FCFF	HRK 136	HRK 145	HRK 155	HRK 166	HRK 177	

Discount at \$ Cost of Capital (WACC) = 10.7% (.974) + 5.40% (0.026) = 10.55%

Cost of Equity 10.70%

Cost of Debt
 $(4.25\% + 0.5\% + 2\%)(1 - .20) = 5.40\%$

Weights
 E = 97.4% D = 2.6%

On May 1, 2010
 AG Pfd price = 279 HRK
 AG Common = 345 HRK

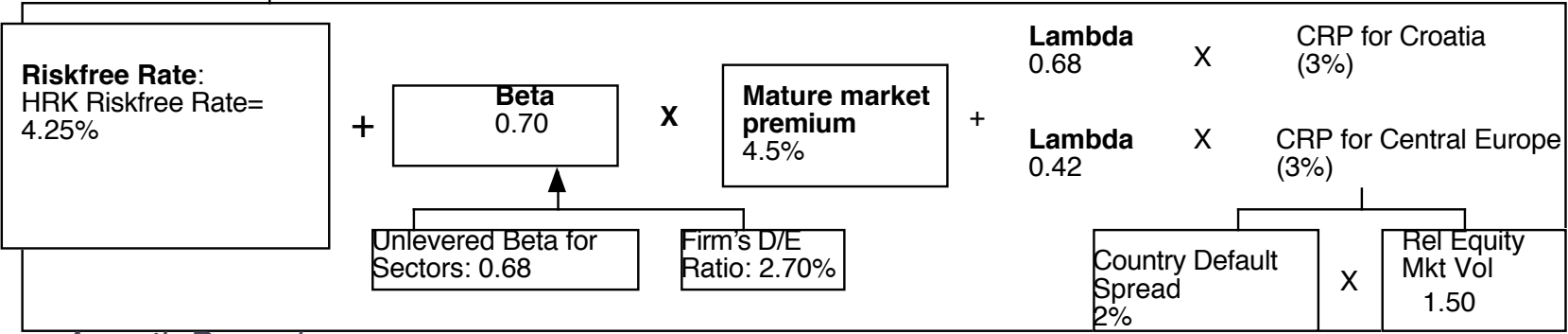

Adris Grupa: 4/2010 (Restructured)

Increased ROIC to cost of capital

Current Cashflow to Firm
 EBIT(1-t) : 436 HRK
 - Nt CpX 3 HRK
 - Chg WC -118 HRK
 = FCFF 551 HRK
 Reinv Rate = (3-118)/436 = -26.35%;
 Tax rate = 17.35%
 Return on capital = 8.72%

Average from 2004-09
70.83%

Reinvestment Rate
70.83%

Expected Growth from new inv.
 $.7083 \times .01054 = 0.00746$
 or 6.86%

Return on Capital
10.54%

Stable Growth
 $g = 4\%$; Beta = 0.80
 Country Premium = 2%
 Cost of capital = 9.65%
 Tax rate = 20.00%
 ROC = 9.94%;
 Reinvestment Rate = $g/ROC = 4/9.65 = 41.47\%$

Terminal Value₅ = $367 / (.0965 - .04) = 6508$ HRK

HKR Cashflows

Op. Assets 4545
 + Cash: 1787
 - Debt 141
 - Minority int 465
 = Equity 5,735

 Value/non-voting 334
 Value/voting 362

Year	1	2	3	4	5	
EBIT (1-t)	HRK 469	HRK 503	HRK 541	HRK 581	HRK 623	628
- Reinvestment	HRK 332	HRK 356	HRK 383	HRK 411	HRK 442	246
FCFF	HRK 137	HRK 147	HRK 158	HRK 169	HRK 182	367

Discount at \$ Cost of Capital (WACC) = 11.12% (.90) + 8.20% (0.10) = 10.55%

Changed mix of debt and equity to optimal

On May 1, 2010
 AG Pfd price = 279 HRK
 AG Common = 345 HRK

Cost of Equity 11.12%

Cost of Debt
 $(4.25\% + 4\% + 2\%) (1 - .20) = 8.20\%$

Weights
 E = 90 % D = 10 %

Riskfree Rate:
 HRK Riskfree Rate = 4.25%

+

Beta
0.75

x

Mature market premium
4.5%

+

Lambda
0.68

0.42

x

CRP for Croatia (3%)

CRP for Central Europe (3%)

Unlevered Beta for Sectors: 0.68

Firm's D/E Ratio: 11.1%

Country Default Spread 2%

x

Rel Equity Mkt Vol 1.50

Value of Control and the Value of Voting Rights

- Adris Grupa has two classes of shares outstanding: 9.616 million voting shares and 6.748 million non-voting shares.
- To value a non-voting share, we assume that all non-voting shares essentially have to settle for status quo value. All shareholders, common and preferred, get an equal share of the status quo value.

Status Quo Value of Equity = 5,484 million HKR

Value for a non-voting share = $5484 / (9.616 + 6.748) = 334$ HKR/share

- To value a voting share, we first value control in Adris Grup as the difference between the optimal and the status quo value:

Value of control at Adris Grupa = $5,735 - 5484 = 249$ million HKR

Value per voting share = $334 \text{ HKR} + 249 / 9.616 = 362$ HKR

Aswath Damodaran



THE DARK SIDE OF VALUATION: VALUING DIFFICULT-TO-VALUE COMPANIES



The Dark Side of Valuation...

- Valuing stable, money making companies with consistent and clear accounting statements, a long and stable history and lots of comparable firms is easy to do.
- The true test of your valuation skills is when you have to value “difficult” companies. In particular, the challenges are greatest when valuing:
 - Young companies, early in the life cycle, in young businesses
 - Companies that don’t fit the accounting mold
 - Companies that face substantial truncation risk (default or nationalization risk)

I. The challenge with young companies...

Figure 5.2: Estimation Issues - Young and Start-up Companies

Making judgments on revenues/ profits difficult because you cannot draw on history. If you have no product/ service, it is difficult to gauge market potential or profitability. The company's entire value lies in future growth but you have little to base your estimate on.

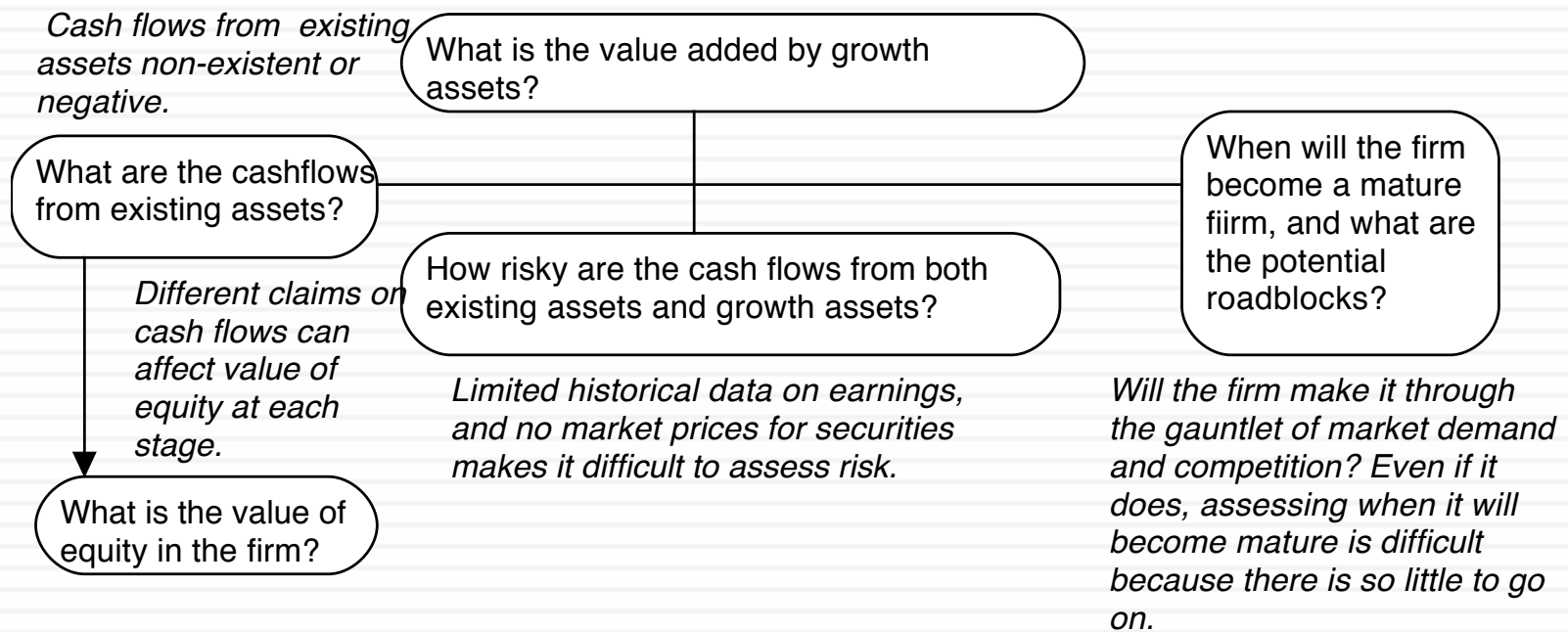

Amazon in January 2000

Sales to capital ratio and expected margin are retail industry average numbers

Stable Growth

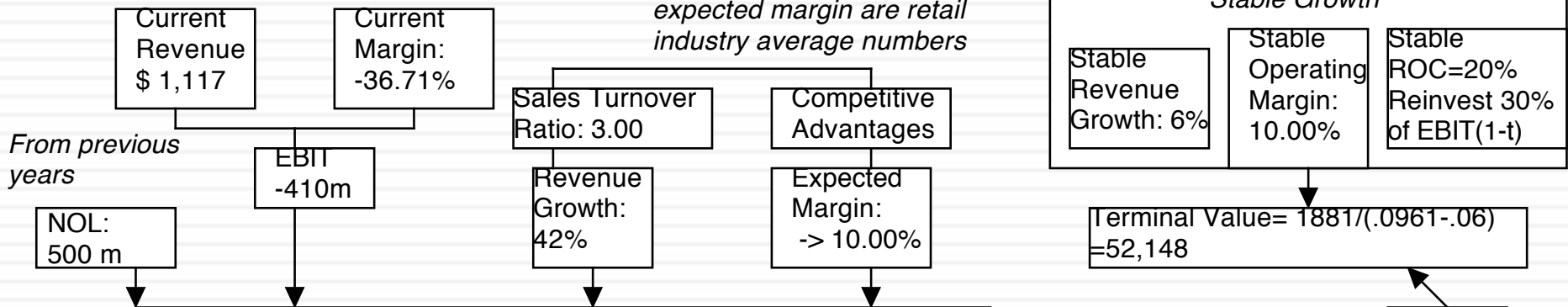

Value of Op Assets \$ 15,170
 + Cash \$ 26
 = Value of Firm \$15,196
 - Value of Debt \$ 349
 = Value of Equity \$14,847
 - Equity Options \$ 2,892
 Value per share \$ 35.08

All existing options valued as options, using current stock price of \$84.

	150.00%	100.00%	75.00%	50.00%	30.00%	25.20%	20.40%	15.60%	10.80%	6.00%	Term. Year
Revenues	\$ 2,793	\$ 5,585	\$ 9,774	\$ 14,661	\$ 19,059	\$ 23,862	\$ 28,729	\$ 33,211	\$ 36,798	\$ 39,006	\$ 41,346
Operating Margin	-13.35%	-1.68%	4.16%	7.08%	8.54%	9.27%	9.64%	9.82%	9.91%	9.95%	10.00%
EBIT	-\$373	-\$94	\$407	\$1,038	\$1,628	\$2,212	\$2,768	\$3,261	\$3,646	\$3,883	\$4,135
EBIT(1-t)	-\$373	-\$94	\$407	\$871	\$1,058	\$1,438	\$1,799	\$2,119	\$2,370	\$2,524	\$2,688
- Reinvestment	\$600	\$967	\$1,420	\$1,663	\$1,543	\$1,688	\$1,721	\$1,619	\$1,363	\$961	\$155
FCFF	-\$931	-\$1,024	-\$989	-\$758	-\$408	-\$163	\$177	\$625	\$1,174	\$1,788	\$1,881

	1	2	3	4	5	6	7	8	9	10	Forever
Cost of Equity	12.90%	12.90%	12.90%	12.90%	12.90%	12.42%	11.94%	11.46%	10.98%	10.50%	
Cost of Debt	8.00%	8.00%	8.00%	8.00%	8.00%	7.80%	7.75%	7.67%	7.50%	7.00%	
After-tax cost of debt	8.00%	8.00%	8.00%	6.71%	5.20%	5.07%	5.04%	4.98%	4.88%	4.55%	
Cost of Capital	12.84%	12.84%	12.84%	12.83%	12.81%	12.13%	11.62%	11.08%	10.49%	9.61%	

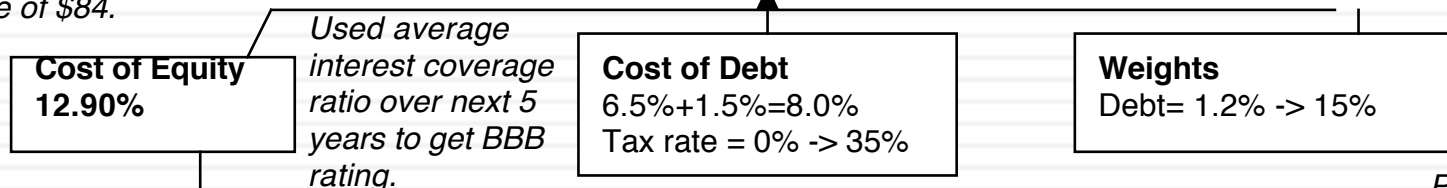

Amazon was trading at \$84 in January 2000.

Pushed debt ratio to retail industry average of 15%.

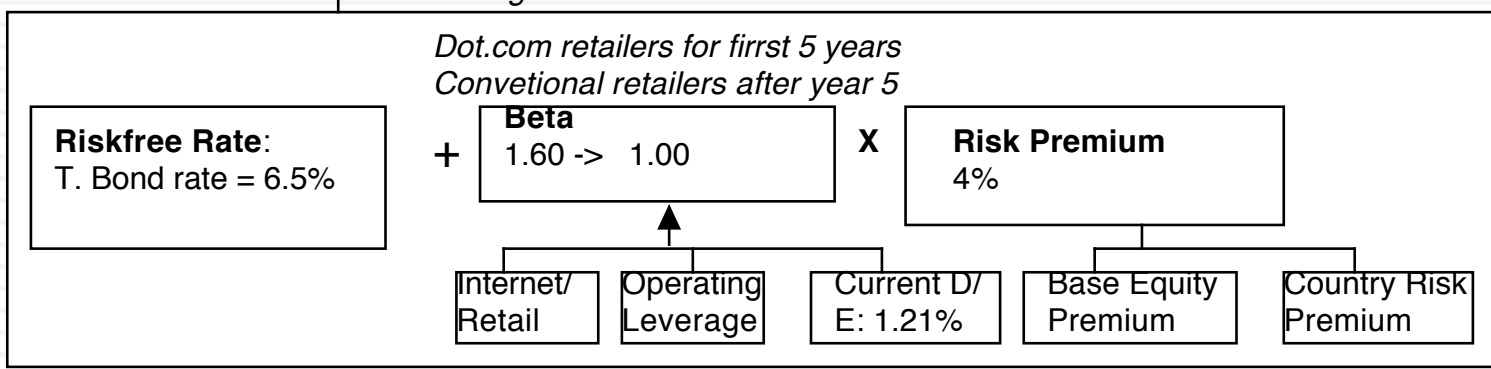

Starting numbers

	Last 10K	Trailing 12 month
Revenues	\$316.93	\$534.46
Operating income	-\$77.06	-\$134.91
Adjusted Operating Income		\$7.67
Invested Capital		\$955.00
Adjusted Operatng Margin		1.44%
Sales/ Invested Capital		0.56
Interest expenses	\$2.49	\$5.30

Twitter Pre-IPO Valuation: October 27, 2013

Revenue growth of 51.5% a year for 5 years, tapering down to 2.5% in year 10

Pre-tax operating margin increases to 25% over the next 10 years

Sales to capital ratio of 1.50 for incremental sales

Stable Growth
 g = 2.5%; Beta = 1.00;
 Cost of capital = 8%
 ROC = 12%;
 Reinvestment Rate = 2.5%/12% = 20.83%

Terminal Value₁₀ = 1466 / (.08 - .025) = \$26,657

	1	2	3	4	5	6	7	8	9	10
Revenues	\$ 810	\$1,227	\$1,858	\$2,816	\$4,266	\$6,044	\$7,973	\$9,734	\$10,932	\$11,205
Operating Income	\$ 31	\$ 75	\$ 158	\$ 306	\$ 564	\$ 941	\$1,430	\$1,975	\$ 2,475	\$ 2,801
Operating Income after tax	\$ 31	\$ 75	\$ 158	\$ 294	\$ 395	\$ 649	\$ 969	\$1,317	\$ 1,624	\$ 1,807
- Reinvestment	\$ 183	\$ 278	\$ 421	\$ 638	\$ 967	\$1,186	\$1,285	\$1,175	\$ 798	\$ 182
FCFF	\$(153)	\$(203)	\$(263)	\$(344)	\$(572)	\$(537)	\$(316)	\$ 143	\$ 826	\$ 1,625

Terminal year (11)	
EBIT (1-t)	\$ 1,852
- Reinvestment	\$ 386
FCFF	\$ 1,466

Operating assets	\$9,705
+ Cash	321
+ IPO Proceeds	1295
- Debt	214
Value of equity	11,106
- Options	713
Value in stock	10,394
/ # of shares	582.46
Value/share	\$17.84

Cost of capital = 11.12% (.981) + 5.16% (.019) = 11.01%

Cost of capital decreases to 8% from years 6-10

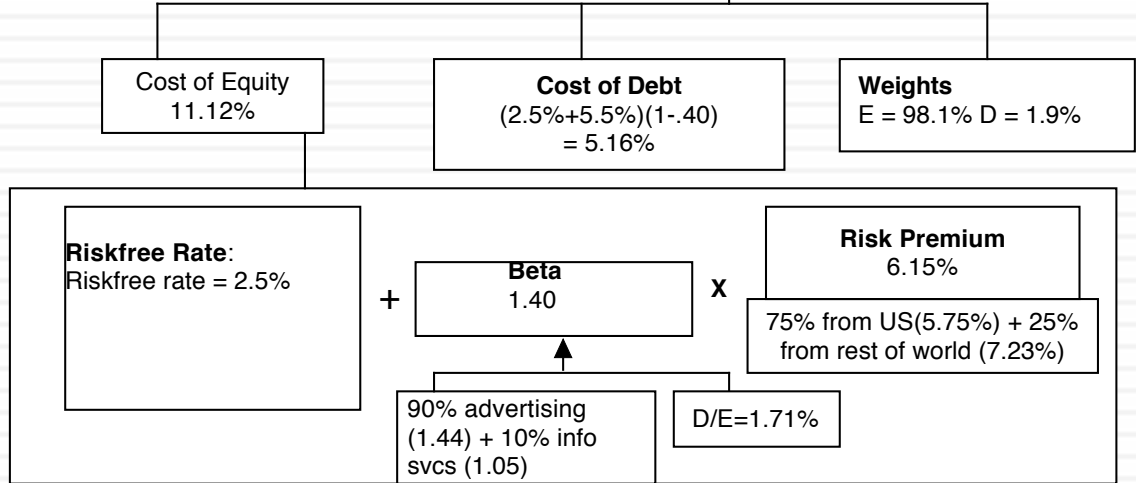

1. Less is more

64

Year	Revenue Growth	Sales	Operating Margin	EBIT	EBIT (1-t)
Tr 12 mths		\$1,117	-36.71%	-\$410	-\$410
1	150.00%	\$2,793	-13.35%	-\$373	-\$373
2	100.00%	\$5,585	-1.68%	-\$94	-\$94
3	75.00%	\$9,774	4.16%	\$407	\$407
4	50.00%	\$14,661	7.08%	\$1,038	\$871
5	30.00%	\$19,059	8.54%	\$1,628	\$1,058
6	25.20%	\$23,862	9.27%	\$2,212	\$1,438
7	20.40%	\$28,729	9.64%	\$2,768	\$1,799
8	15.60%	\$33,211	9.82%	\$3,261	\$2,119
9	10.80%	\$36,798	9.91%	\$3,646	\$2,370
10	6.00%	\$39,006	9.95%	\$3,883	\$2,524
TY	6.00%	\$41,346	10.00%	\$4,135	\$2,688

Principle of parsimony: Estimate fewer inputs when faced with uncertainty.

Use “auto pilot” approaches to estimate future years

A tougher task at Twitter

65

	2011		2012		2013	
	%	\$	%	\$	%	\$
Google	32.09%	\$27.74	31.46%	\$32.73	33.24%	\$38.83
Facebook	3.65%	\$3.15	4.11%	\$4.28	5.04%	\$5.89
Yahoo!	3.95%	\$3.41	3.37%	\$3.51	3.10%	\$3.62
Microsoft	1.27%	\$1.10	1.63%	\$1.70	1.78%	\$2.08
IAC	1.15%	\$0.99	1.39%	\$1.45	1.47%	\$1.72
AOL	1.17%	\$1.01	1.02%	\$1.06	0.95%	\$1.11
Amazon	0.48%	\$0.41	0.59%	\$0.61	0.71%	\$0.83
Pandora	0.28%	\$0.24	0.36%	\$0.37	0.50%	\$0.58
Twitter	0.16%	\$0.14	0.28%	\$0.29	0.50%	\$0.58
Linkedin	0.18%	\$0.16	0.25%	\$0.26	0.32%	\$0.37
Millennial Media	0.05%	\$0.04	0.07%	\$0.07	0.10%	\$0.12
Other	55.59%	\$48.05	55.47%	\$57.71	52.29%	\$61.09
Total Market	100%	\$86.43	100.00%	\$104.04	100.00%	\$116.82

Company	Operating Margin
Google Inc. (NasdaqGS:GOOG)	22.82%
Facebook, Inc. (NasdaqGS:FB)	29.99%
Yahoo! Inc. (NasdaqGS:YHOO)	13.79%
Netfix	3.16%
Groupon	2.53%
LinkedIn Corporation (NYSE:LNKD)	5.18%
Pandora Media, Inc. (NYSE:P)	-9.13%
Yelp, Inc. (NYSE:YELP)	-6.19%
OpenTable, Inc. (NasdaqGS:OPEN)	24.90%
RetailMeNot	45.40%
Travelzoo Inc. (NasdaqGS:TZOO)	15.66%
Zillow, Inc. (NasdaqGS:Z)	-66.60%
Trulia, Inc. (NYSE:TRLA)	-6.79%
Aggregate	20.40%

		Annual growth rate in Global Advertising Spending				
		2.00%	2.50%	3.00%	3.50%	4.00%
Online advertising share of market	20%	\$124.78	\$131.03	\$137.56	\$144.39	\$151.52
	25%	\$155.97	\$163.79	\$171.95	\$180.49	\$189.40
	30%	\$187.16	\$196.54	\$206.34	\$216.58	\$227.28
	35%	\$218.36	\$229.30	\$240.74	\$252.68	\$265.16
	40%	\$249.55	\$262.06	\$275.13	\$288.78	\$303.04

My estimate for 2023: Overall market will be close to \$200 billion and Twitter will about 5.7% (\$11.5 billion)

*My estimate for Twitter:
Operating margin of 25% in year 10*

Aswath Damodaran

2. Build in “internal” checks for reasonableness...

66

Year	Revenues	Δ Revenue	Sales/Cap	Δ Investment	Invested Capital	EBIT (1-t)	Imputed ROC
Tr 12 mths	\$1,117				\$ 487	-\$410	
1	\$2,793	\$1,676	3.00	\$559	\$ 1,045	-\$373	-76.62%
2	\$5,585	\$2,793	3.00	\$931	\$ 1,976	-\$94	-8.96%
3	\$9,774	\$4,189	3.00	\$1,396	\$ 3,372	\$407	20.59%
4	\$14,661	\$4,887	3.00	\$1,629	\$ 5,001	\$871	25.82%
5	\$19,059	\$4,398	3.00	\$1,466	\$ 6,467	\$1,058	21.16%
6	\$23,862	\$4,803	3.00	\$1,601	\$ 8,068	\$1,438	22.23%
7	\$28,729	\$4,868	3.00	\$1,623	\$ 9,691	\$1,799	22.30%
8	\$33,211	\$4,482	3.00	\$1,494	\$ 11,185	\$2,119	21.87%
9	\$36,798	\$3,587	3.00	\$1,196	\$ 12,380	\$2,370	21.19%
10	\$39,006	\$2,208	3.00	\$736	\$ 13,116	\$2,524	20.39%
TY	\$41,346	\$2,340	NA		Assumed to be =		20.00%

*Check total revenues, relative to the market that it serves...
Your market share obviously cannot exceed 100% but there may be tighter constraints.*

Are the margins and imputed returns on capital ‘reasonable’ in the outer years?

Lesson 3: Scaling up is hard to do...

Typically, the revenue growth rate of a newly public company outpaces its industry average for only about five years.

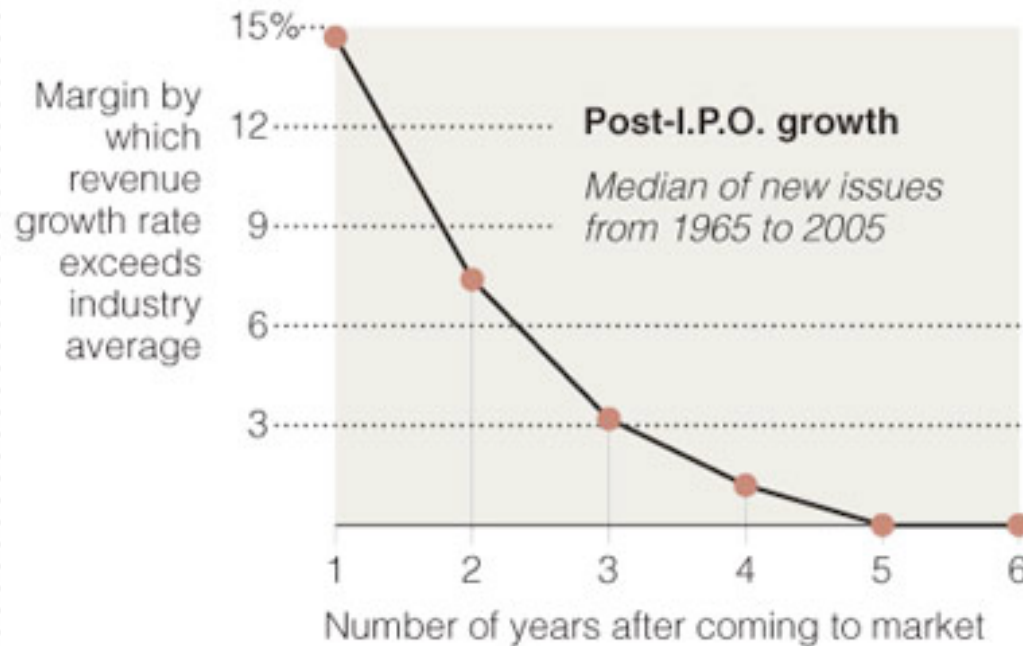

Source: Andrew Metrick

The New York Times

Lesson 4: Don't forget to pay for growth...

Year	Revenues	Δ Revenue	Sales/Cap	Δ Investment	Invested Capital	EBIT (1-t)	Imputed ROC
Tr 12 mths	\$1,117				\$ 487	-\$410	
1	\$2,793	\$1,676	3.00	\$559	\$ 1,045	-\$373	-76.62%
2	\$5,585	\$2,793	3.00	\$931	\$ 1,976	-\$94	-8.96%
3	\$9,774	\$4,189	3.00	\$1,396	\$ 3,372	\$407	20.59%
4	\$14,661	\$4,887	3.00	\$1,629	\$ 5,001	\$871	25.82%
5	\$19,059	\$4,398	3.00	\$1,466	\$ 6,467	\$1,058	21.16%
6	\$23,862	\$4,803	3.00	\$1,601	\$ 8,068	\$1,438	22.23%
7	\$28,729	\$4,868	3.00	\$1,623	\$ 9,691	\$1,799	22.30%
8	\$33,211	\$4,482	3.00	\$1,494	\$ 11,185	\$2,119	21.87%
9	\$36,798	\$3,587	3.00	\$1,196	\$ 12,380	\$2,370	21.19%
10	\$39,006	\$2,208	3.00	\$736	\$ 13,116	\$2,524	20.39%
TY	\$41,346	\$2,340	NA		Assumed to be =		20.00%

Lesson 5: Don't sweat the small stuff: The discount rate is not the "big" number

Twitter's cost of capital

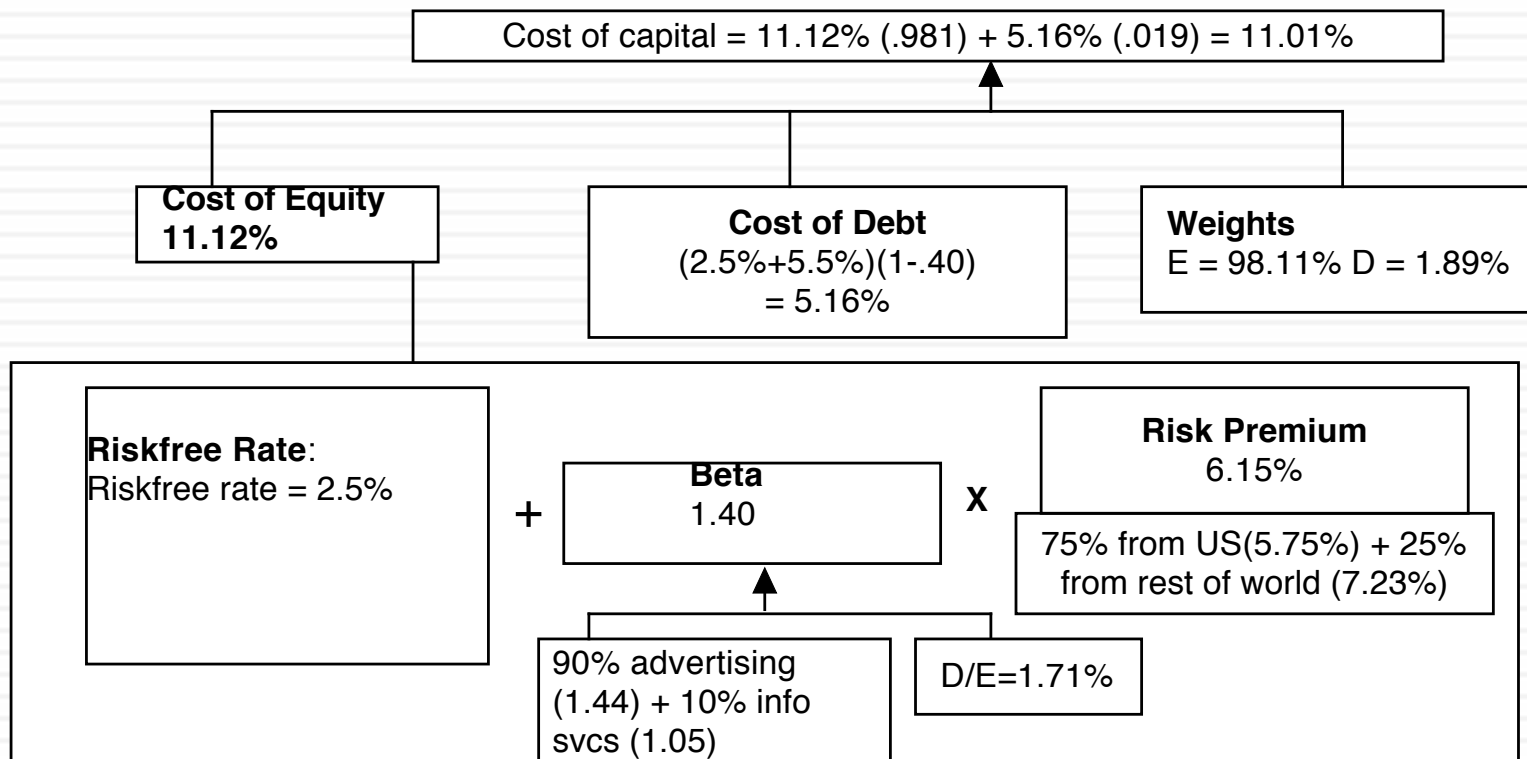

Lesson 5: There are always scenarios where the market price can be justified...

		Target pre-tax Operating Margin				
		6%	8%	10%	12%	14%
Compounded annual Revenue Growth rate	30%	\$ (1.94)	\$ 2.95	\$ 7.84	\$ 12.71	\$ 17.57
	35%	\$ 1.41	\$ 8.37	\$ 15.33	\$ 22.27	\$ 29.21
	40%	\$ 6.10	\$ 15.93	\$ 25.74	\$ 35.54	\$ 45.34
	45%	\$ 12.59	\$ 26.34	\$ 40.05	\$ 53.77	\$ 67.48
	50%	\$ 21.47	\$ 40.50	\$ 59.52	\$ 78.53	\$ 97.54
	55%	\$ 33.47	\$ 59.60	\$ 85.72	\$ 111.84	\$ 137.95
	60%	\$ 49.53	\$ 85.10	\$ 120.66	\$ 156.22	\$ 191.77

Lesson 6: You will be wrong 100% of the time... and it really is not (always) your fault...

- No matter how careful you are in getting your inputs and how well structured your model is, your estimate of value will change both as new information comes out about the company, the business and the economy.
- As information comes out, you will have to adjust and adapt your model to reflect the information. Rather than be defensive about the resulting changes in value, recognize that this is the essence of risk.
- A test: If your valuations are unbiased, you should find yourself increasing estimated values as often as you are decreasing values. In other words, there should be equal doses of good and bad news affecting valuations (at least over time).

And the market is often “more wrong”

Amazon: Value and Price

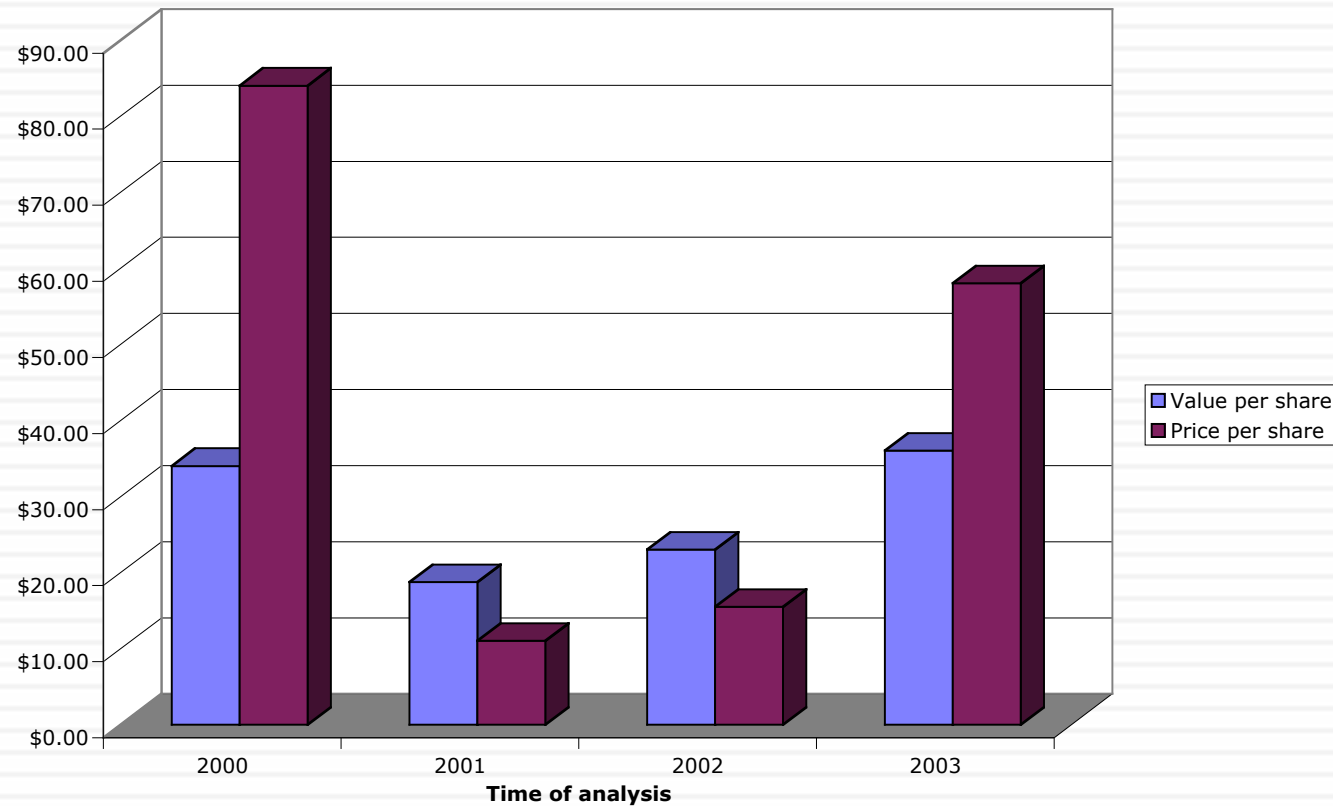

II. Dealing with decline and distress...

Historical data often reflects flat or declining revenues and falling margins. Investments often earn less than the cost of capital.

Growth can be negative, as firm sheds assets and shrinks. As less profitable assets are shed, the firm's remaining assets may improve in quality.

What is the value added by growth assets?

What are the cashflows from existing assets?

Underfunded pension obligations and litigation claims can lower value of equity. Liquidation preferences can affect value of equity

What is the value of equity in the firm?

How risky are the cash flows from both existing assets and growth assets?

Depending upon the risk of the assets being divested and the use of the proceeds from the divestiture (to pay dividends or retire debt), the risk in both the firm and its equity can change.

When will the firm become a mature firm, and what are the potential roadblocks?

There is a real chance, especially with high financial leverage, that the firm will not make it. If it is expected to survive as a going concern, it will be as a much smaller entity.

Current Revenue
\$ 4,390

Current Margin:
4.76%

EBIT
\$ 209m

Reinvestment:
Capital expenditures include cost of new casinos and working capital

Extended reinvestment break, due to investment in past

Industry average

Expected Margin:
-> 17%

Stable Growth
Stable Revenue Growth: 3%
Stable Operating Margin: 17%
Stable ROC=10%
Reinvest 30% of EBIT(1-t)

Terminal Value = $758 \cdot (0.0743 - 0.03)$
= \$ 17,129

Value of Op Assets \$ 9,793
+ Cash & Non-op \$ 3,040
= Value of Firm \$ 12,833
- Value of Debt \$ 7,565
= Value of Equity \$ 5,268

Value per share \$ 8.12

Revenues	\$4,434	\$4,523	\$5,427	\$6,513	\$7,815	\$8,206	\$8,616	\$9,047	\$9,499	\$9,974
Oper margin	5.81%	6.86%	7.90%	8.95%	10%	11.40%	12.80%	14.20%	15.60%	17%
EBIT	\$258	\$310	\$429	\$583	\$782	\$935	\$1,103	\$1,285	\$1,482	\$1,696
Tax rate	26.0%	26.0%	26.0%	26.0%	26.0%	28.4%	30.8%	33.2%	35.6%	38.00%
EBIT * (1 - t)	\$191	\$229	\$317	\$431	\$578	\$670	\$763	\$858	\$954	\$1,051
- Reinvestment	-\$19	-\$11	\$0	\$22	\$58	\$67	\$153	\$215	\$286	\$350
FCFF	\$210	\$241	\$317	\$410	\$520	\$603	\$611	\$644	\$668	\$701
Beta	3.14	3.14	3.14	3.14	3.14	2.75	2.36	1.97	1.59	1.20
Cost of equity	21.82%	21.82%	21.82%	21.82%	21.82%	19.50%	17.17%	14.85%	12.52%	10.20%
Cost of debt	9%	9%	9%	9%	9%	8.70%	8.40%	8.10%	7.80%	7.50%
Debt/ratio	73.50%	73.50%	73.50%	73.50%	73.50%	68.80%	64.10%	59.40%	54.70%	50.00%
Cost of capital	9.88%	9.88%	9.88%	9.88%	9.88%	9.79%	9.50%	9.01%	8.32%	7.43%

Term. Year
\$10,273
17%
\$ 1,746
38%
\$1,083
\$ 325
\$758

Forever

Cost of Equity
21.82%

Cost of Debt
3%+6%= 9%
9% (1-.38)=5.58%

Weights
Debt= 73.5% ->50%

Riskfree Rate:
T. Bond rate = 3%

+

Beta
3.14-> 1.20

X

Risk Premium
6%

Aswath Damodaran

Casino
1.15

Current
D/E: 277%

Base Equity
Premium

Country Risk
Premium

Las Vegas Sands
February 2009
Trading @ \$4.25

Adjusting the value of LVS for distress..

- In February 2009, LVS was rated B+ by S&P. Historically, 28.25% of B+ rated bonds default within 10 years. LVS has a 6.375% bond, maturing in February 2015 (7 years), trading at \$529. If we discount the expected cash flows on the bond at the riskfree rate, we can back out the probability of distress from the bond price:

$$529 = \sum_{t=1}^{t=7} \frac{63.75(1 - \Pi_{\text{Distress}})^t}{(1.03)^t} + \frac{1000(1 - \Pi_{\text{Distress}})^7}{(1.03)^7}$$

- Solving for the probability of bankruptcy, we get:
- π_{Distress} = Annual probability of default = 13.54%
 - ▣ Cumulative probability of surviving 10 years = $(1 - .1354)^{10} = 23.34\%$
 - ▣ Cumulative probability of distress over 10 years = $1 - .2334 = .7666$ or 76.66%
- If LVS is becomes distressed:
 - ▣ Expected distress sale proceeds = \$2,769 million < Face value of debt
 - ▣ Expected equity value/share = \$0.00
- Expected value per share = $\$8.12 (1 - .7666) + \$0.00 (.7666) = \$1.92$

III. Valuing cyclical and commodity companies

Company growth often comes from movements in the economic cycle, for cyclical firms, or commodity prices, for commodity companies.

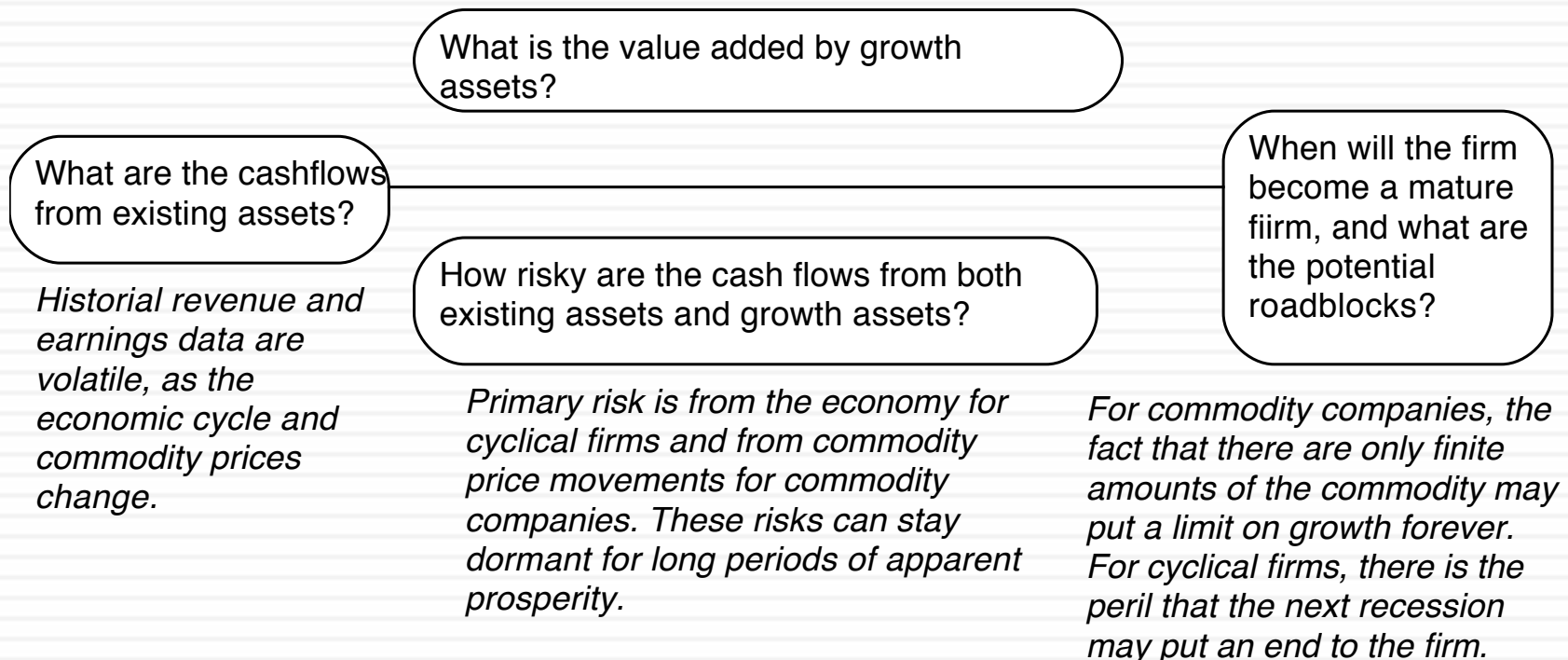

Valuing Vale in November 2013 (in US dollars)

Let's start with some history & estimate what a normalized year will look like

Year	Operating Income (\$)	Effective tax rate	BV of Debt	BV of Equity	Cash	Invested capital	Return on capital
2009	\$6,057	27.79%	\$18,168	\$42,556	\$12,639	\$48,085	9.10%
2010	\$23,033	18.67%	\$23,613	\$59,766	\$11,040	\$72,339	25.90%
2011	\$30,206	18.54%	\$27,668	\$70,076	\$9,913	\$87,831	28.01%
2012	\$13,346	18.96%	\$23,116	\$78,721	\$3,538	\$98,299	11.00%
2013 (TTM)	\$15,487	20.65%	\$30,196	\$75,974	\$5,818	\$100,352	12.25%
Normalized	\$17,626	20.92%					17.25%

Estimate the costs of equity & capital for Vale

Business	Sample size	Unlevered beta of business	Revenues	Peer Group EV/Sales	Value of Business	Proportion of Vale
Metals & Min	48	0.86	\$9,013	1.97	\$17,739	16.65%
Iron Ore	78	0.83	\$32,717	2.48	\$81,188	76.20%
Fertilizers	693	0.99	\$3,777	1.52	\$5,741	5.39%
Logistics	223	0.75	\$1,644	1.14	\$1,874	1.76%
Vale Operations		0.8440	\$47,151		\$106,543	100.00%

Market D/E = 54.99%

Marginal tax rate = 34.00% (Brazil)

Levered Beta = 0.844 (1+(1-.34)(.5499)) = 1.10

Cost of equity = 2.75% + 1.10 (7.38%) = 11.23%

	% of revenues	ERP
US & Canada	4.90%	5.50%
Brazil	16.90%	8.50%
Rest of Latin America	1.70%	10.09%
China	37.00%	6.94%
Japan	10.30%	6.70%
Rest of Asia	8.50%	8.61%
Europe	17.20%	6.72%
Rest of World	3.50%	10.06%
Vale ERP	100.00%	7.38%

Vale's rating: A-

Default spread based on rating = 1.30%

Cost of debt (pre-tax) = 2.75% + 1.30% = 4.05%

Cost of capital = 11.23% (.6452) + 4.05% (1-.34) (.3548) = 8.20%

Assume that the company is in stable growth, growing 2% a year in perpetuity

$$\text{Reinvestment Rate} = \frac{g}{ROC} = \frac{2\%}{17.25\%} = 11.59\%$$

$$\text{Value of Operating Assets} = \frac{17,626 (1 - .2092)(1 - .1159)}{(.082 - .02)} = \$202,832$$

Aswath Damodaran

Value of operating assets	= \$202,832
+ Cash & Marketable Securities	= \$ 7,133
- Debt	= \$ 42,879
Value of equity	= \$167,086
Value per share	= \$ 32.44
Stock price (11/2013)	= \$ 13.57

Aswath Damodaran



RELATIVE VALUATION

Aswath Damodaran

Relative valuation is pervasive...

- Most asset valuations are relative.
- Most equity valuations on Wall Street are relative valuations.
 - ▣ Almost 85% of equity research reports are based upon a multiple and comparables.
 - ▣ More than 50% of all acquisition valuations are based upon multiples
 - ▣ Rules of thumb based on multiples are not only common but are often the basis for final valuation judgments.
- While there are more discounted cashflow valuations in consulting and corporate finance, they are often relative valuations masquerading as discounted cash flow valuations.
 - ▣ The objective in many discounted cashflow valuations is to back into a number that has been obtained by using a multiple.
 - ▣ The terminal value in a significant number of discounted cashflow valuations is estimated using a multiple.

The Reasons for the allure...

- “If you think I’m crazy, you should see the guy who lives across the hall”

Jerry Seinfeld talking about Kramer in a Seinfeld episode

- “A little inaccuracy sometimes saves tons of explanation”

H.H. Munro

- “If you are going to screw up, make sure that you have lots of company”

Ex-portfolio manager

The Four Steps to Deconstructing Multiples

- Define the multiple
 - In use, the same multiple can be defined in different ways by different users. When comparing and using multiples, estimated by someone else, it is critical that we understand how the multiples have been estimated
- Describe the multiple
 - Too many people who use a multiple have no idea what its cross sectional distribution is. If you do not know what the cross sectional distribution of a multiple is, it is difficult to look at a number and pass judgment on whether it is too high or low.
- Analyze the multiple
 - It is critical that we understand the fundamentals that drive each multiple, and the nature of the relationship between the multiple and each variable.
- Apply the multiple
 - Defining the comparable universe and controlling for differences is far more difficult in practice than it is in theory.

Definitional Tests

- Is the multiple consistently defined?
 - Proposition 1: Both the value (the numerator) and the standardizing variable (the denominator) should be to the same claimholders in the firm. In other words, the value of equity should be divided by equity earnings or equity book value, and firm value should be divided by firm earnings or book value.
- Is the multiple uniformly estimated?
 - The variables used in defining the multiple should be estimated uniformly across assets in the “comparable firm” list.
 - If earnings-based multiples are used, the accounting rules to measure earnings should be applied consistently across assets. The same rule applies with book-value based multiples.

Example 1: Price Earnings Ratio: Definition

PE = Market Price per Share / Earnings per Share

- There are a number of variants on the basic PE ratio in use. They are based upon how the price and the earnings are defined.

Price: is usually the current price

is sometimes the average price for the year

EPS: EPS in most recent financial year

EPS in trailing 12 months (Trailing PE)

Forecasted EPS next year (Forward PE)

Forecasted EPS in future year

Example 2: Enterprise Value /EBITDA Multiple

- The enterprise value to EBITDA multiple is obtained by netting cash out against debt to arrive at enterprise value and dividing by EBITDA.

$$\frac{\text{Enterprise Value}}{\text{EBITDA}} = \frac{\text{Market Value of Equity} + \text{Market Value of Debt} - \text{Cash}}{\text{Earnings before Interest, Taxes and Depreciation}}$$

- Why do we net out cash from firm value?
- What happens if a firm has cross holdings which are categorized as:
 - ▣ Minority interests?
 - ▣ Majority active interests?

Descriptive Tests

- What is the average and standard deviation for this multiple, across the universe (market)?
- What is the median for this multiple?
 - The median for this multiple is often a more reliable comparison point.
- How large are the outliers to the distribution, and how do we deal with the outliers?
 - Throwing out the outliers may seem like an obvious solution, but if the outliers all lie on one side of the distribution (they usually are large positive numbers), this can lead to a biased estimate.
- Are there cases where the multiple cannot be estimated? Will ignoring these cases lead to a biased estimate of the multiple?
- How has this multiple changed over time?

1. Multiples have skewed distributions...

PE Ratios for US stocks: January 2014

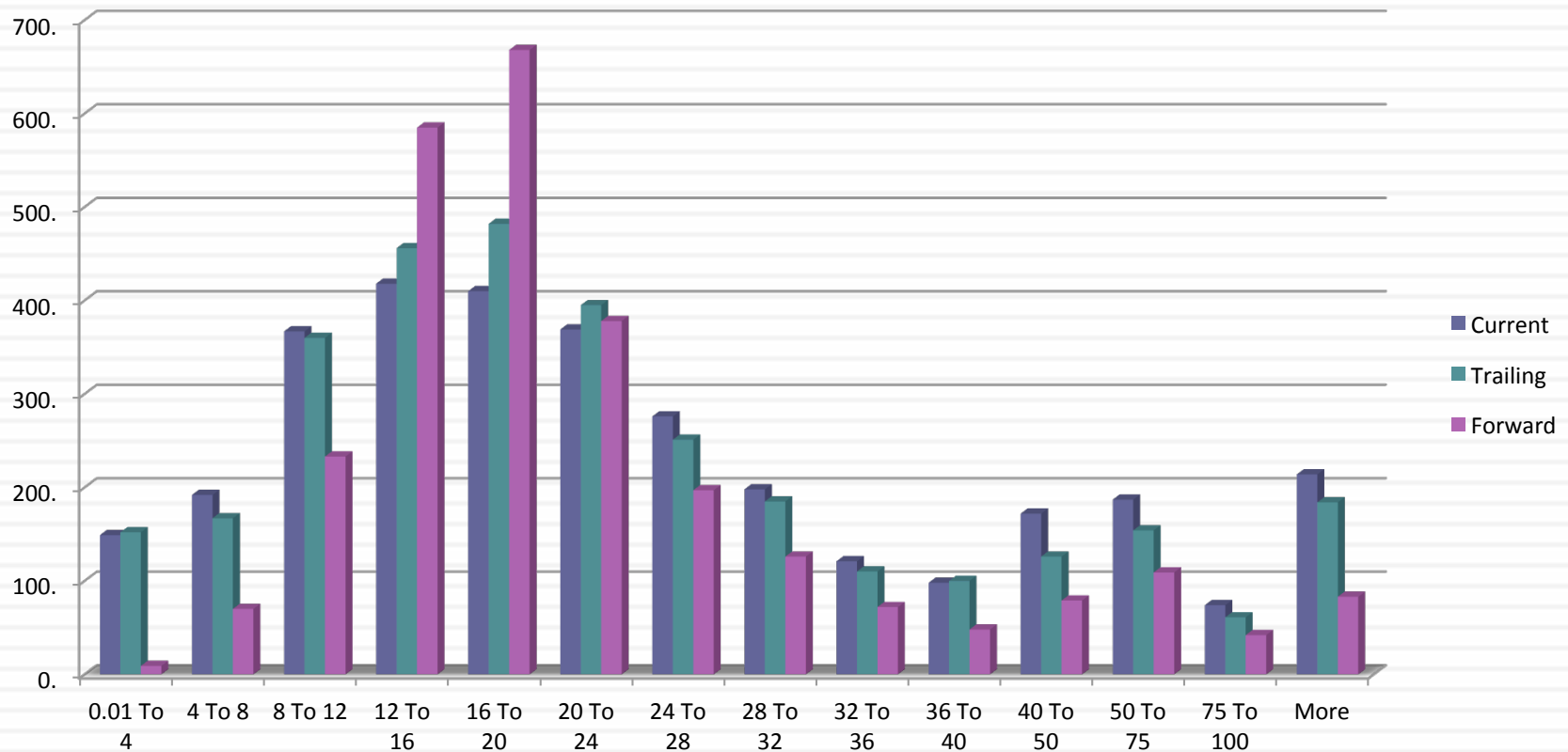

2. Making statistics “dicey”

	<i>Current PE</i>	<i>Trailing PE</i>	<i>Forward PE</i>
Number of firms	7766	7766	7766
Number with PE	3248	3186	2699
Average	52.13	50.14	38.62
Median	20.78	19.75	18.54
Minimum	0.25	0.4	0.52
Maximum	7,117.43	7,117.43	16,820.
Standard deviation	242.03	249.64	349.38
Standard error	4.25	4.42	6.72
Skewness	18.29	17.62	42.99
25th percentile	13.004	12.97	14.7
75th percentile	33.66	30.47	25.13

3. Markets have a lot in common : Comparing Global PEs

PE Ratio Distribution: Global Comparison in January 2014

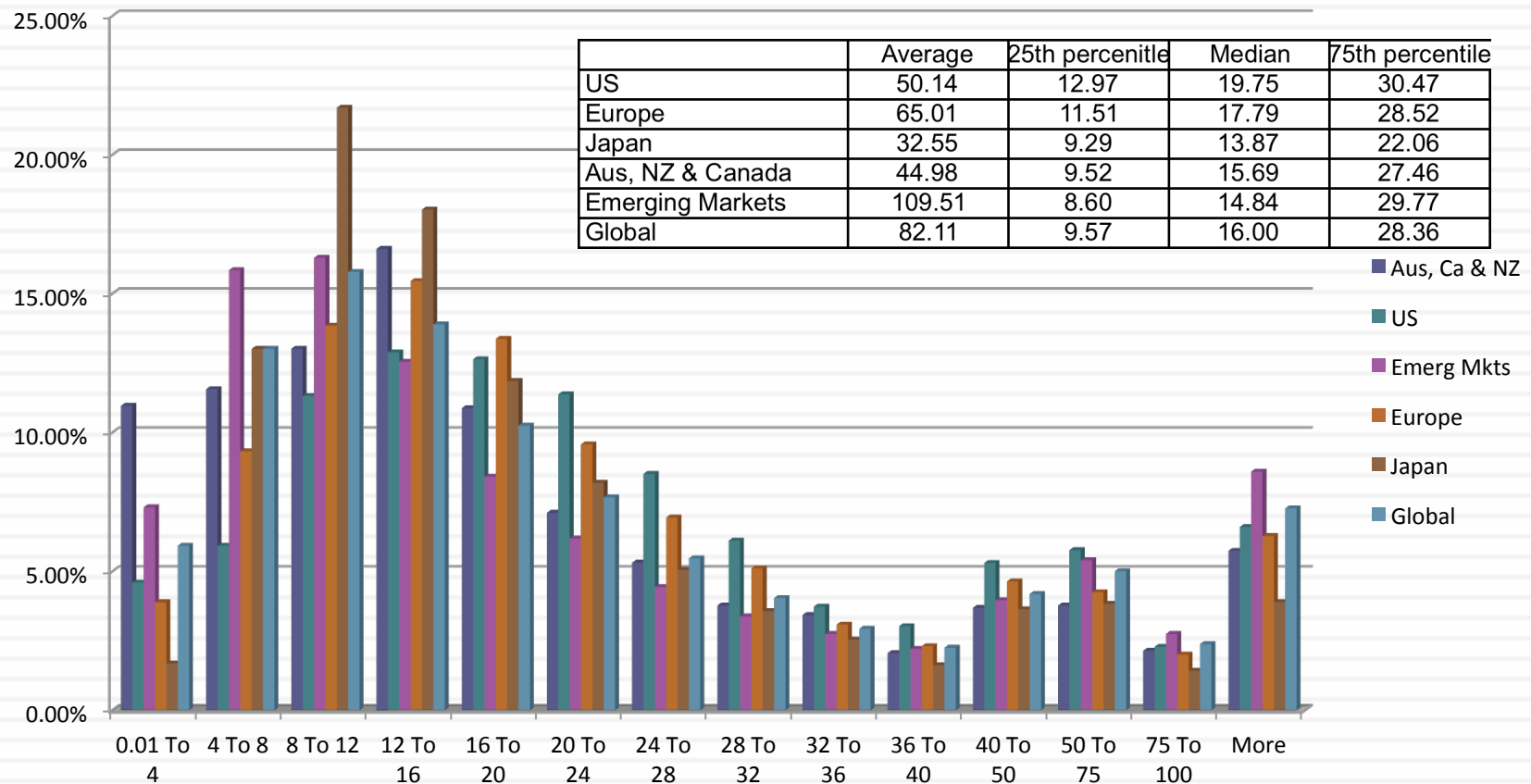

4. Simplistic rules almost always break down...6 times EBITDA may not be cheap...

EV/EBITDA: A Global Comparison - January 2014

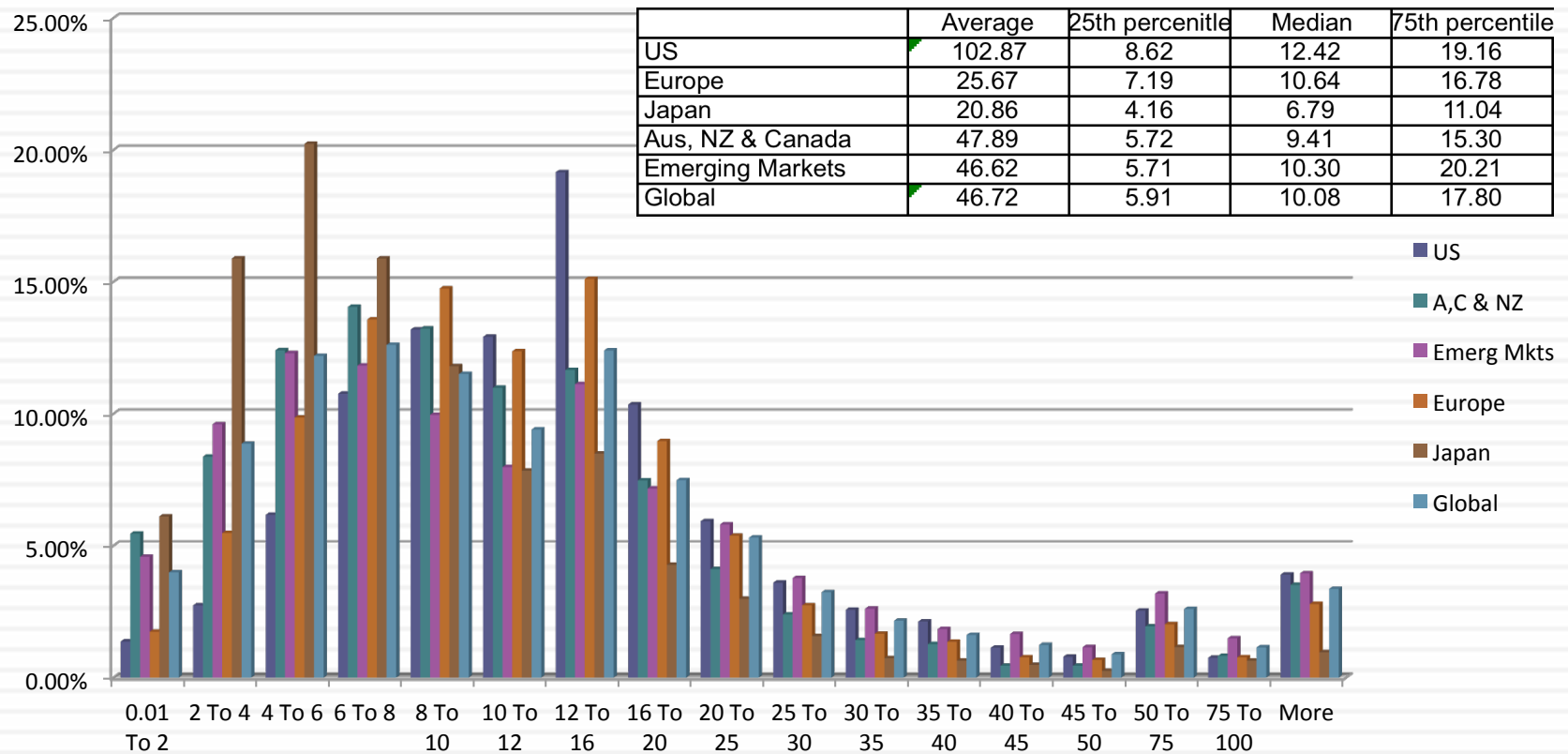

Analytical Tests

- What are the fundamentals that determine and drive these multiples?
 - Proposition 2: Embedded in every multiple are all of the variables that drive every discounted cash flow valuation - growth, risk and cash flow patterns.
 - In fact, using a simple discounted cash flow model and basic algebra should yield the fundamentals that drive a multiple
- How do changes in these fundamentals change the multiple?
 - The relationship between a fundamental (like growth) and a multiple (such as PE) is seldom linear. For example, if firm A has twice the growth rate of firm B, it will generally not trade at twice its PE ratio
 - Proposition 3: It is impossible to properly compare firms on a multiple, if we do not know the nature of the relationship between fundamentals and the multiple.

PE Ratio: Understanding the Fundamentals

- To understand the fundamentals, start with a basic equity discounted cash flow model.
- With the dividend discount model,

$$P_0 = \frac{DPS_1}{r - g_n}$$

- Dividing both sides by the current earnings per share,

$$\frac{P_0}{EPS_0} = PE = \frac{\text{Payout Ratio} * (1 + g_n)}{r - g_n}$$

- If this had been a FCFE Model,

$$P_0 = \frac{FCFE_1}{r - g_n}$$

Aswath Damodaran

$$\frac{P_0}{EPS_0} = PE = \frac{(\text{FCFE/Earnings}) * (1 + g_n)}{r - g_n}$$

The Determinants of Multiples...

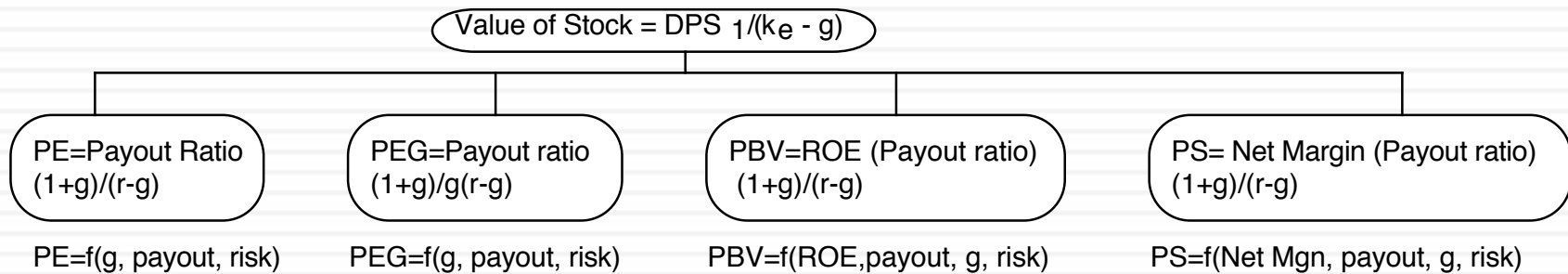

Equity Multiples

Firm Multiples

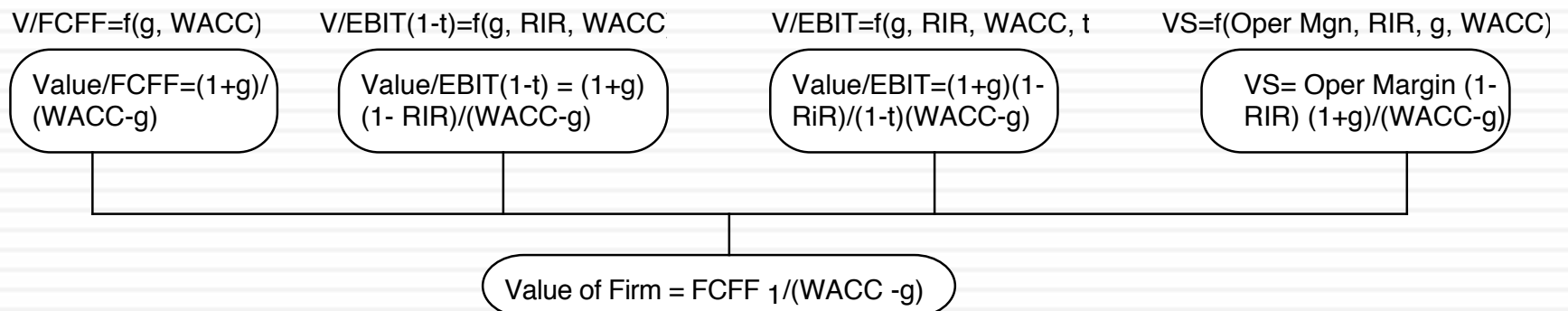

Application Tests

- Given the firm that we are valuing, what is a “comparable” firm?
 - While traditional analysis is built on the premise that firms in the same sector are comparable firms, valuation theory would suggest that a comparable firm is one which is similar to the one being analyzed in terms of fundamentals.
 - Proposition 4: There is no reason why a firm cannot be compared with another firm in a very different business, if the two firms have the same risk, growth and cash flow characteristics.
- Given the comparable firms, how do we adjust for differences across firms on the fundamentals?
 - Proposition 5: It is impossible to find an exactly identical firm to the one you are valuing.

An Example: Comparing PE Ratios across a Sector: PE

<i>Company Name</i>	<i>PE</i>	<i>Growth</i>
<i>PT Indosat ADR</i>	7.8	0.06
<i>Telebras ADR</i>	8.9	0.075
<i>Telecom Corporation of New Zealand ADR</i>	11.2	0.11
<i>Telecom Argentina Stet - France Telecom SA ADR B</i>	12.5	0.08
<i>Hellenic Telecommunication Organization SA ADR</i>	12.8	0.12
<i>Telecomunicaciones de Chile ADR</i>	16.6	0.08
<i>Swisscom AG ADR</i>	18.3	0.11
<i>Asia Satellite Telecom Holdings ADR</i>	19.6	0.16
<i>Portugal Telecom SA ADR</i>	20.8	0.13
<i>Telefonos de Mexico ADR L</i>	21.1	0.14
<i>Matav RT ADR</i>	21.5	0.22
<i>Telstra ADR</i>	21.7	0.12
<i>Gilat Communications</i>	22.7	0.31
<i>Deutsche Telekom AG ADR</i>	24.6	0.11
<i>British Telecommunications PLC ADR</i>	25.7	0.07
<i>Tele Danmark AS ADR</i>	27	0.09
<i>Telekomunikasi Indonesia ADR</i>	28.4	0.32
<i>Cable & Wireless PLC ADR</i>	29.8	0.14
<i>APT Satellite Holdings ADR</i>	31	0.33
<i>Telefonica SA ADR</i>	32.5	0.18
<i>Royal KPN NV ADR</i>	35.7	0.13
<i>Telecom Italia SPA ADR</i>	42.2	0.14
<i>Nippon Telegraph & Telephone ADR</i>	44.3	0.2
<i>France Telecom SA ADR</i>	45.2	0.19
<i>Korea Telecom ADR</i>	71.3	0.44

PE, Growth and Risk

- Dependent variable is: PE
- R squared = 66.2% R squared (adjusted) = 63.1%

Variable	Coefficient	SE	t-ratio	Probability
Constant	13.1151	3.471	3.78	0.0010
Growth rate	121.223	19.27	6.29	≤ 0.0001
Emerging Market	-13.853	13.606	-3.84	0.0009
Emerging Market is a dummy:			1 if emerging market 0 if not	

Applying to Telebras,

$$\text{Predicted PE} = 13.15 + 121.22 (.075) - 13.85 = 8.39$$

After controlling for lower growth & higher risk, the stock is overvalued.

Comparisons across the market

96

Region	Regression – January 2014	R ²
US	PE = 4.20 + 149.0 g _{EPS} + 13.40 Payout - 2.86 Beta	33.6%
Europe	PE = 11.51 + 41.73 g _{EPS} + 14.36 Payout - 1.75 Beta	37.7%
Japan	PE = 11.01 + 17.30 g _{EPS} + 31.22 Payout	16.9%
Emerging Markets	PE = 8.52 + 56.2 g _{EPS} + 10.04 Payout - 1.43 Beta	20.0%
Global	PE = 11.79 + 50.39 g _{EPS} + 15.86 Payout - 1.01 Beta - 61.15 ERP	33.1%

g_{EPS} = Expected Growth: Expected growth in EPS or Net Income: Next 5 years

Beta: Regression or Bottom up Beta

Payout ratio: Dividends/ Net income from most recent year. Set to zero, if net income < 0

ERP: Equity Risk Premium (total) for country in which company is incorporated

Conventional usage...

Sector	Multiple Used	Rationale
Cyclical Manufacturing	PE, Relative PE	Often with normalized earnings
Growth firms	PEG ratio	Big differences in growth rates
Young growth firms w/ losses	Revenue Multiples	What choice do you have?
Infrastructure	EV/EBITDA	Early losses, big DA
REIT	P/CFE (where CFE = Net income + Depreciation)	Big depreciation charges on real estate
Financial Services	Price/ Book equity	Marked to market?
Retailing	Revenue multiples	Margins equalize sooner or later

A closing thought...

