

Website: <http://www.damodaran.com>

Blog: <http://aswathdamodaran.blogspot.com>

Twitter: @AswathDamodaran

App (iPad/iPhone): [uValue \(in iTunes app store\)](#)

Aswath Damodaran

VALUATION: ART, SCIENCE, CRAFT OR MAGIC?

Aswath Damodaran
www.damodaran.com

Some Initial Thoughts

" One hundred thousand lemmings cannot be wrong"

Graffiti

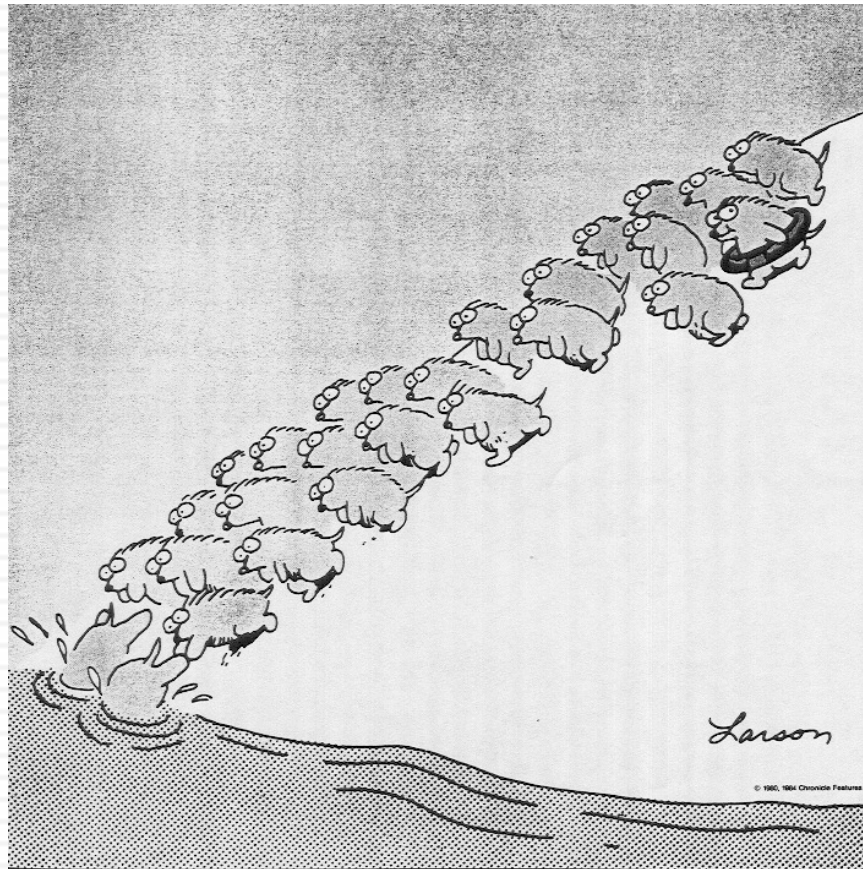

Aswath Damodaran

Misconceptions about Valuation

- Myth 1: A valuation is an objective search for “true” value
 - ▣ Truth 1.1: All valuations are biased. The only questions are how much and in which direction.
 - ▣ Truth 1.2: The direction and magnitude of the bias in your valuation is directly proportional to who pays you and how much you are paid.
- Myth 2.: A good valuation provides a precise estimate of value
 - ▣ Truth 2.1: There are no precise valuations
 - ▣ Truth 2.2: The payoff to valuation is greatest when valuation is least precise.
- Myth 3: . The more quantitative a model, the better the valuation
 - ▣ Truth 3.1: One’ s understanding of a valuation model is inversely proportional to the number of inputs required for the model.
 - ▣ Truth 3.2: Simpler valuation models do much better than complex ones.

Approaches to Valuation

- **Intrinsic valuation**, relates the value of an asset to the present value of expected future cashflows on that asset. In its most common form, this takes the form of a discounted cash flow valuation.
- **Relative valuation**, estimates the value of an asset by looking at the pricing of 'comparable' assets relative to a common variable like earnings, cashflows, book value or sales.
- **Contingent claim valuation**, uses option pricing models to measure the value of assets that share option characteristics.

Discounted Cash Flow Valuation

- *What is it:* In discounted cash flow valuation, the value of an asset is the present value of the expected cash flows on the asset.
- *Philosophical Basis:* Every asset has an intrinsic value that can be estimated, based upon its characteristics in terms of cash flows, growth and risk.
- *Information Needed:* To use discounted cash flow valuation, you need
 - to estimate the life of the asset
 - to estimate the cash flows during the life of the asset
 - to estimate the discount rate to apply to these cash flows to get present value
- *Market Inefficiency:* Markets are assumed to make mistakes in pricing assets across time, and are assumed to correct themselves over time, as new information comes out about assets.

Intrinsic Value: Four Basic Propositions

6

The value of an asset is the present value of the expected cash flows on that asset, over its expected life:

$$\text{Value of asset} = \frac{E(\text{CF}_1)}{(1+r)} + \frac{E(\text{CF}_2)}{(1+r)^2} + \frac{E(\text{CF}_3)}{(1+r)^3} \dots + \frac{E(\text{CF}_n)}{(1+r)^n}$$

1. *The IT Proposition:* If “it” does not affect the cash flows or alter risk (thus changing discount rates), “it” cannot affect value.
2. *The DUH Proposition:* For an asset to have value, the expected cash flows have to be positive some time over the life of the asset.
3. *The DON'T FREAK OUT Proposition:* Assets that generate cash flows early in their life will be worth more than assets that generate cash flows later; the latter may however have greater growth and higher cash flows to compensate.
4. *The VALUE IS NOT PRICE Proposition:* The value of an asset may be very different from its price.

DCF Choices: Equity Valuation versus Firm Valuation

Firm Valuation: Value the entire business

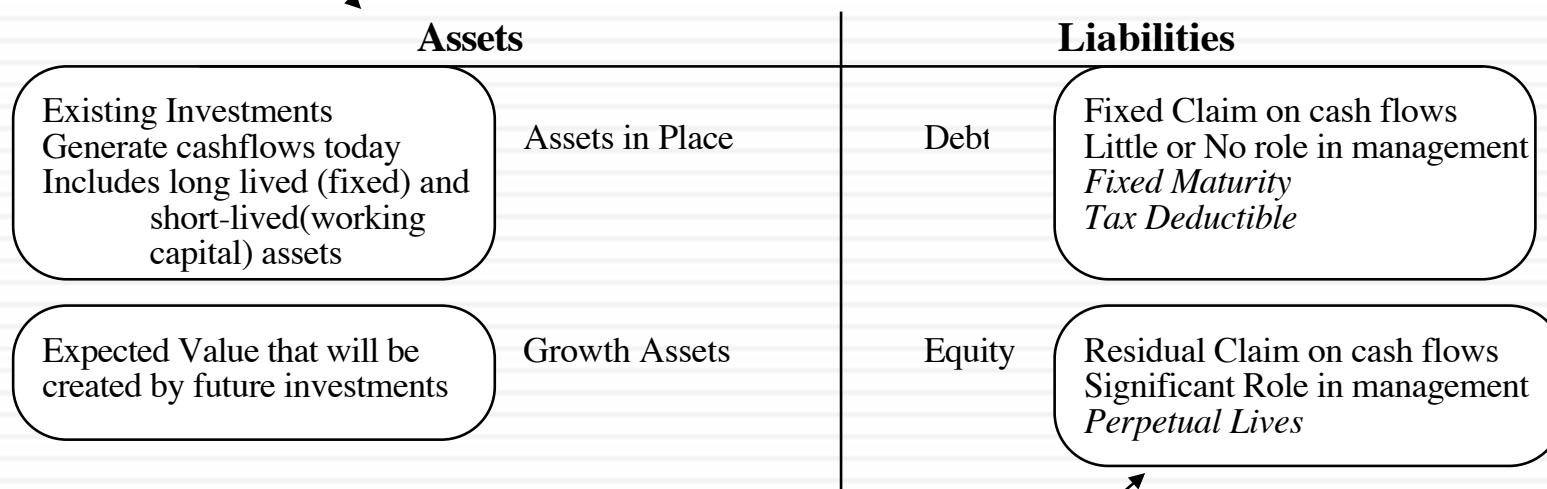

Equity valuation: Value just the equity claim in the business

The Drivers of Value...

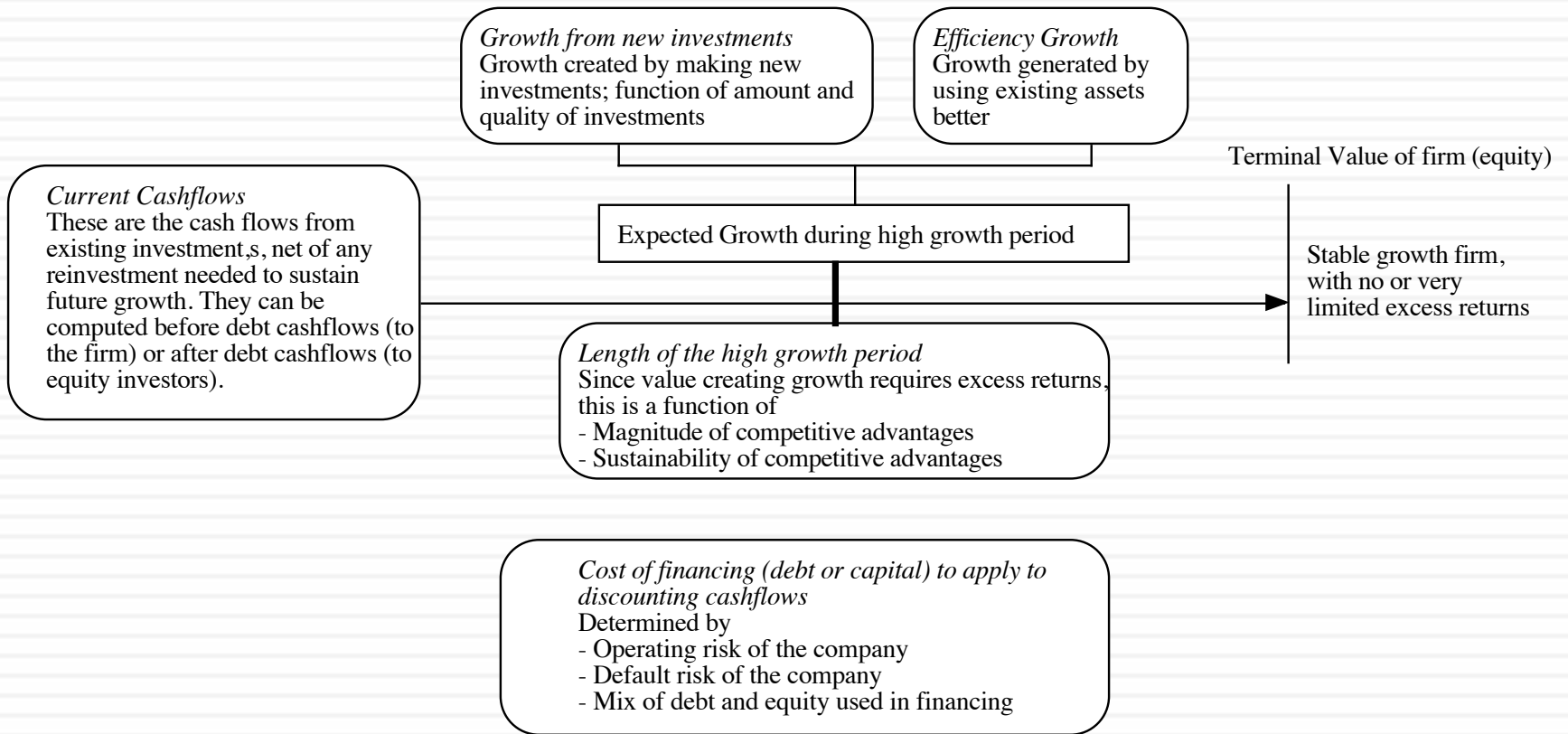

DISCOUNTED CASHFLOW VALUATION

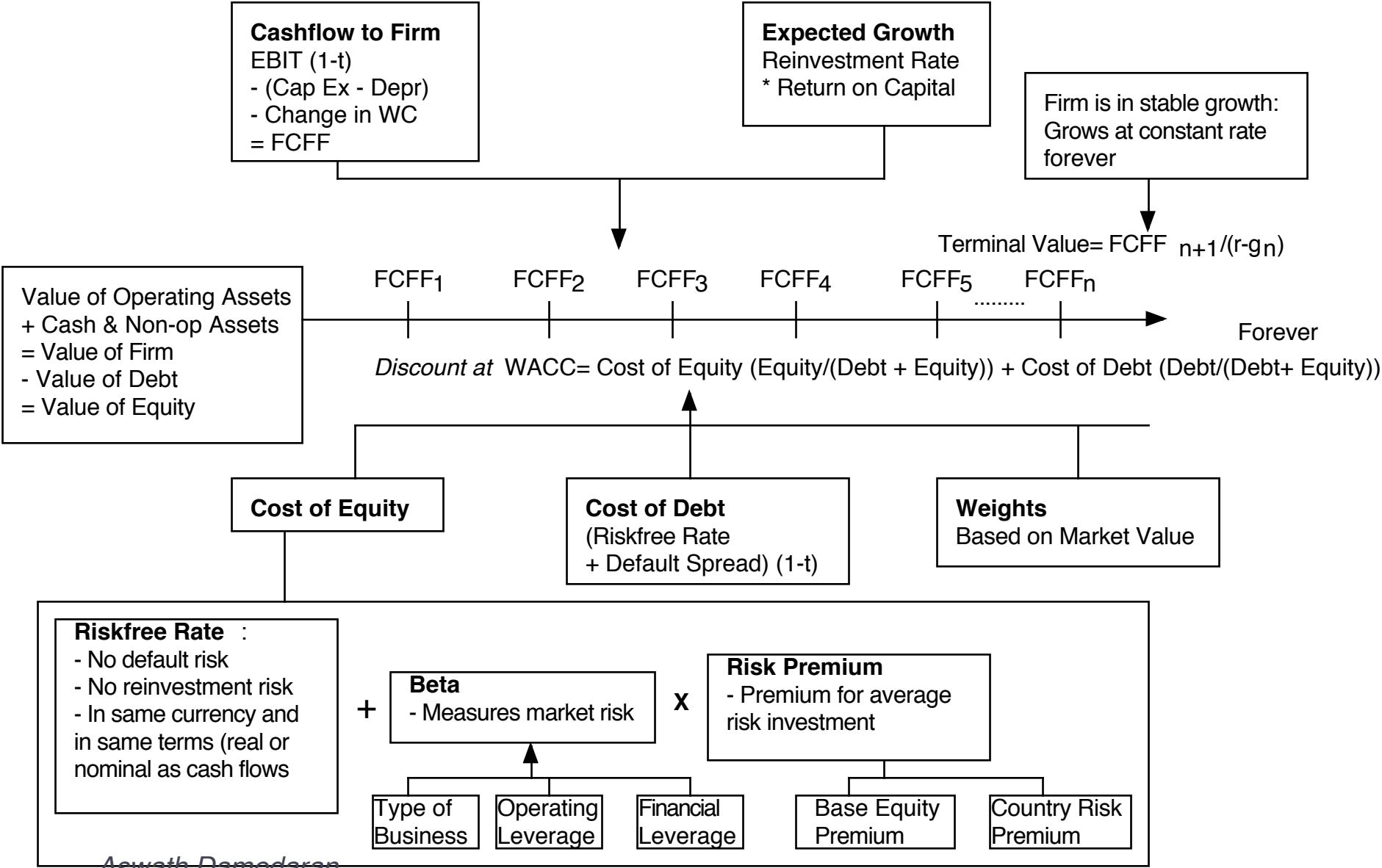

Amgen: Status Quo

Cap Ex = Acc net Cap Ex(255) + Acquisitions (3975) + R&D (2216)

Current Cashflow to Firm

EBIT(1-t) = :7336(1-.28) = 6058
 - Nt CpX = 6443
 - Chg WC 37
 = FCFF - 423
 Reinvestment Rate = 6480/6058 = 106.98%
 Return on capital = 16.71%

Reinvestment Rate 60%

Expected Growth in EBIT (1-t)
 $.60 * .16 = .096$
 9.6%

Return on Capital 16%

Stable Growth

g = 4%; Beta = 1.10;
 Debt Ratio = 20%; Tax rate = 35%
 Cost of capital = 8.08%
 ROC = 10.00%;
 Reinvestment Rate = 4/10 = 40%

Terminal Value₁₀ = 7300 / (.0808 - .04) = 179,099

First 5 years

Growth decreases gradually to 4%

Op. Assets 94214
 + Cash: 1283
 - Debt 8272
 = Equity 87226
 - Options 479
 Value/Share \$ 74.33

Year	1	2	3	4	5	6	7	8	9	10
EBIT	\$9,221	\$10,106	\$11,076	\$12,140	\$13,305	\$14,433	\$15,496	\$16,463	\$17,306	\$17,998
EBIT (1-t)	\$6,639	\$7,276	\$7,975	\$8,741	\$9,580	\$10,392	\$11,157	\$11,853	\$12,460	\$12,958
- Reinvestment	\$3,983	\$4,366	\$4,785	\$5,244	\$5,748	\$5,820	\$5,802	\$5,690	\$5,482	\$5,183
= FCFF	\$2,656	\$2,911	\$3,190	\$3,496	\$3,832	\$4,573	\$5,355	\$6,164	\$6,978	\$7,775

Term Yr
 18718
 12167
 4867
 7300

Cost of Capital (WACC) = 11.7% (0.90) + 3.66% (0.10) = 10.90%

Debt ratio increases to 20%
 Beta decreases to 1.10

Cost of Equity 11.70%

Cost of Debt
 $(4.78\% + .85\%)(1 - .35)$
 = 3.66%

Weights
 E = 90% D = 10%

On May 1, 2007, Amgen was trading at \$ 55/share

Riskfree Rate:
 Riskfree rate = 4.78%

+

Beta 1.73

x

Risk Premium 4%

Unlevered Beta for Sectors: 1.59

D/E = 11.06%

Aswath Damodaran

Tata Motors: April 2010

Current Cashflow to Firm

EBIT(1-t) : Rs 20,116
 - Nt CpX Rs 31,590
 - Chg WC Rs 2,732
 = FCFF - Rs 14,205
 Reinv Rate = $(31590+2732)/20116 = 170.61\%$; Tax rate = 21.00%
 Return on capital = 17.16%

Average reinvestment rate
 from 2005-09: 179.59%;
 without acquisitions: 70%

Reinvestment Rate
 70%

Expected Growth
 from new inv.
 $.70 \cdot 17.16 = 0.1201$

Return on Capital
 17.16%

Stable Growth
 $g = 5\%$; Beta = 1.00
 Country Premium = 3%
 Cost of capital = 10.39%
 Tax rate = 33.99%
 ROC = 10.39%;
 Reinvestment Rate = $g/ROC = 5/10.39 = 48.11\%$

Rs Cashflows

Terminal Value₅ = $23493 / (.1039 - .05) = \text{Rs } 435,686$

Op. Assets Rs 210,813
 + Cash: 11418
 + Other NO 140576
 - Debt 109198
 = Equity 253,628

Year	1	2	3	4	5	6	7	8	9	10
EBIT (1-t)	22533	25240	28272	31668	35472	39236	42848	46192	49150	51607
- Reinvestment	15773	17668	19790	22168	24830	25242	25138	24482	23264	21503
FCFF	6760	7572	8482	9500	10642	13994	17711	21710	25886	30104

45278
 21785
 23493

Value/Share Rs 614

Discount at Cost of Capital (WACC) = $14.00\% (.747) + 8.09\% (0.253) = 12.50\%$

Growth declines to 5%
 and cost of capital
 moves to stable period
 level.

Cost of Equity
 14.00%

Cost of Debt
 $(5\% + 4.25\% + 3\%)(1 - .3399)$
 = 8.09%

Weights
 E = 74.7% D = 25.3%

On April 1, 2010
 Tata Motors price = Rs 781

Riskfree Rate:
 Rs Riskfree Rate = 5%

+

Beta
 1.20

X

Mature market
 premium
 4.5%

+

Lambda
 0.80

X

Country Equity Risk
 Premium
 4.50%

Aswath Damodaran

Unlevered Beta for
 Sectors: 1.04

Firm's D/E
 Ratio: 33%

Country Default
 Spread
 3%

X

Rel Equity
 Mkt Vol
 1.50

Aswath Damodaran



DCF INPUTS

“Garbage in, garbage out”

I. Measure earnings right..

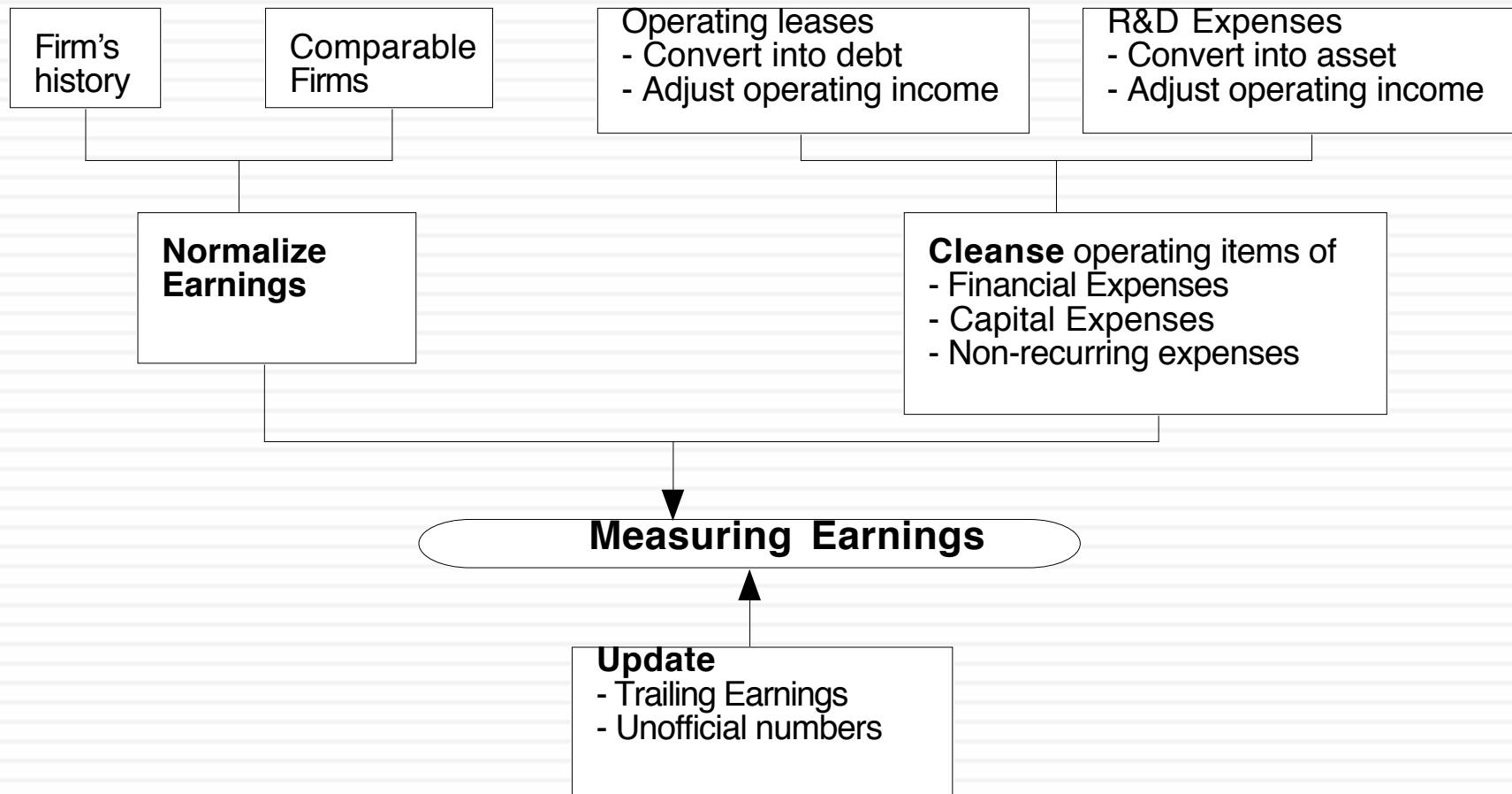

Operating Leases at Amgen in 2007

- Amgen has lease commitments and its cost of debt (based on its A rating) is 5.63%.

Year	Commitment	Present Value
1	\$96.00	\$90.88
2	\$95.00	\$85.14
3	\$102.00	\$86.54
4	\$98.00	\$78.72
5	\$87.00	\$66.16
6-12	\$107.43	\$462.10 (\$752 million prorated)

- Debt Value of leases = \$869.55
- Debt outstanding at Amgen = \$7,402 + \$ 870 = \$8,272 million
- Adjusted Operating Income = Stated OI + Lease expense this year – Depreciation
= 5,071 m + 69 m - 870/12 = \$5,068 million (12 year life for assets)
- Approximate Operating income= stated OI + PV of Lease commitment * Pre-tax cost of debt
= \$5,071 m + 870 m (.0563) = \$ 5,120 million

Capitalizing R&D Expenses: Amgen

- R & D was assumed to have a 10-year life.

Year	R&D Expense	Unamortized portion	Amortization this year	
Current	3366.00	1.00	3366.00	
-1	2314.00	0.90	2082.60	\$231.40
-2	2028.00	0.80	1622.40	\$202.80
-3	1655.00	0.70	1158.50	\$165.50
-4	1117.00	0.60	670.20	\$111.70
-5	865.00	0.50	432.50	\$86.50
-6	845.00	0.40	338.00	\$84.50
-7	823.00	0.30	246.90	\$82.30
-8	663.00	0.20	132.60	\$66.30
-9	631.00	0.10	63.10	\$63.10
-10	558.00	0.00	0.00	\$55.80
Value of Research Asset =			\$10,112.80	\$1,149.90

- Adjusted Operating Income = \$5,120 + 3,366 - 1,150 = \$7,336 million

II. Get the big picture (not the accounting one) when it comes to cap ex and working capital

- Capital expenditures should include
 - ▣ Research and development expenses, once they have been re-categorized as capital expenses.
 - ▣ Acquisitions of other firms, whether paid for with cash or stock.
- Working capital should be defined not as the difference between current assets and current liabilities but as the difference between non-cash current assets and non-debt current liabilities.
- On both items, start with what the company did in the most recent year but do look at the company's history and at industry averages.

Amgen's Net Capital Expenditures

- The accounting net cap ex at Amgen is small:
 - ▣ Accounting Capital Expenditures = \$1,218 million
 - ▣ - Accounting Depreciation = \$ 963 million
 - ▣ Accounting Net Cap Ex = \$ 255 million
- We define capital expenditures broadly to include R&D and acquisitions:
 - ▣ Accounting Net Cap Ex = \$ 255 million
 - ▣ Net R&D Cap Ex = (3366-1150) = \$2,216 million
 - ▣ Acquisitions in 2006 = \$3,975 million
 - ▣ Total Net Capital Expenditures = \$ 6,443 million
- Acquisitions have been a volatile item. Amgen was quiet on the acquisition front in 2004 and 2005 and had a significant acquisition in 2003.

III. The government bond rate is not always the risk free rate

- When valuing Amgen in US dollars, the US\$ ten-year bond rate of 4.78% was used as the risk free rate. We assumed that the US treasury was default free.
- When valuing Tata Motors in Indian rupees in 2010, the Indian government bond rate of 8% was not default free. Using the Indian government's local currency rating of Ba2 yielded a default spread of 3% for India and a riskfree rate of 5% in Indian rupees.

$$\text{Risk free rate in Indian Rupees} = 8\% - 3\% = 5\%$$

Risk free rates will vary across currencies: January 2015

Riskfree Rates: January 2015

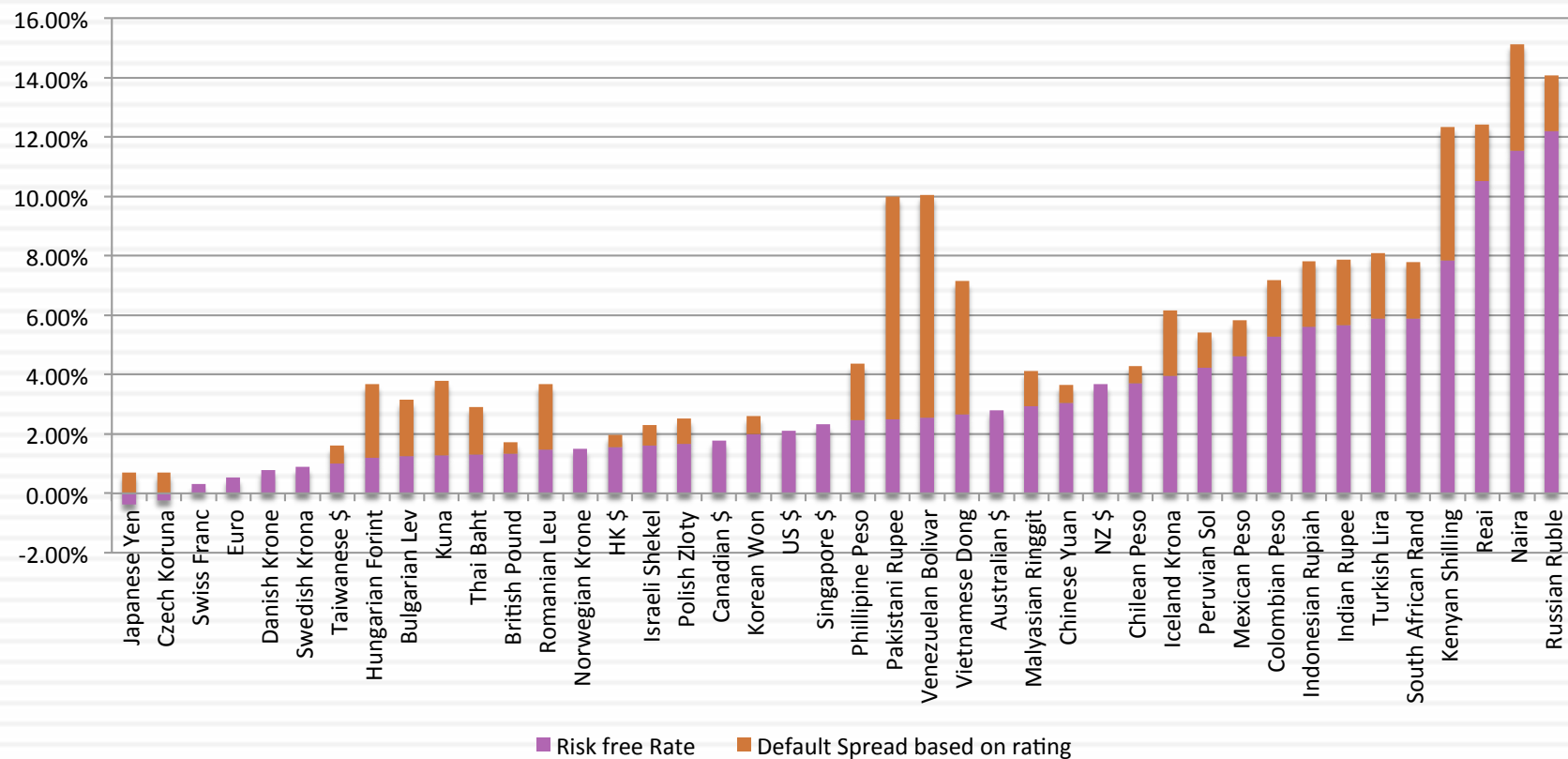

But valuations should not

	In Indian Rupees	In US \$
Risk free Rate	5.00%	2.00%
Expected inflation rate	4.00%	1.00%
Cost of capital		
- High Growth	12.50%	9.25%
- Stable Growth	10.39%	7.21%
Expected growth rate		
- High Growth	12.01%	8.78%
- Stable Growth	5.00%	2.00%
Return on Capital		
- High Growth	17.16%	13.78%
- Stable Growth	10.39%	7.21%
Value per share	Rs 614	\$12.79/share (roughly Rs 614 at current exchange rate)

IV. Betas do not come from regressions... and are noisy...

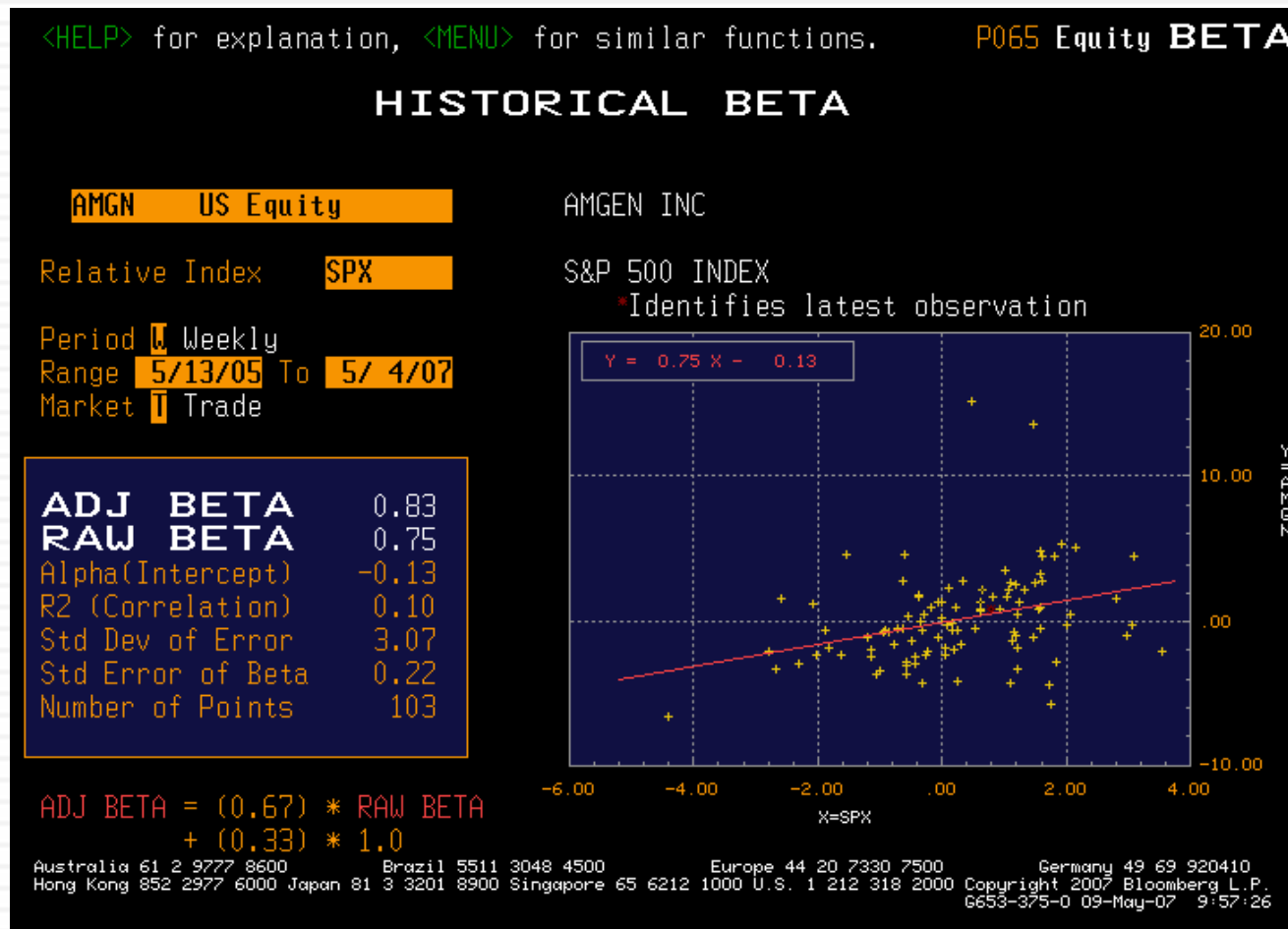

Look better for some companies, but only because they are run against narrow indices

<HELP> for explanation, <MENU> for similar functions.

Equity **BETA**

TTM US Equity Relative Index SPX Index Historical Beta
 Data Last Price Range 04/11/08 - 04/02/10 Period Weekly Local CCY
 Linear Beta +/- Non-Parametric

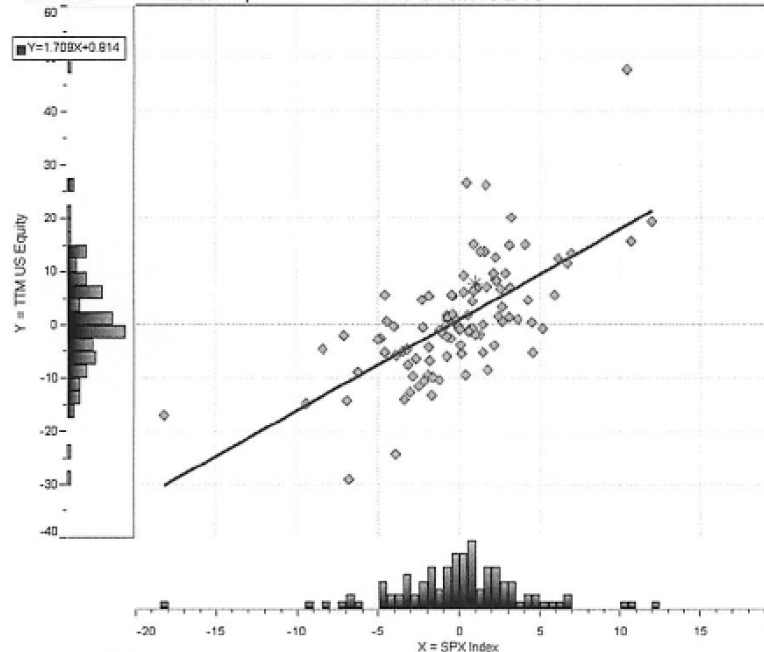

Y = TATA MOTORS LTD-SPON ADR
 X = S&P 500 INDEX

Item	Value
Raw BETA	1.709
Adj BETA	1.473
ALPHA(Intercept)	0.814
R ² (Correlation ²)	0.443
Std Dev Of Error	7.920
Std Error Of ALPHA	0.780
Std Error Of BETA	0.191
Number Of Points	103

Australia 61 2 9777 8600 Brazil 5511 3048 4500 Europe 44 20 7330 7500 Germany 49 69 9204 1210 Hong Kong 852 2977 6000
 Japan 81 3 3201 8900 Singapore 65 6212 1000 U.S. 1 212 318 2000
 Copyright 2010 Bloomberg Finance L.P.
 SN 636136 H003-375-0 09-Apr-2010 15:13:52

Determinants of Betas

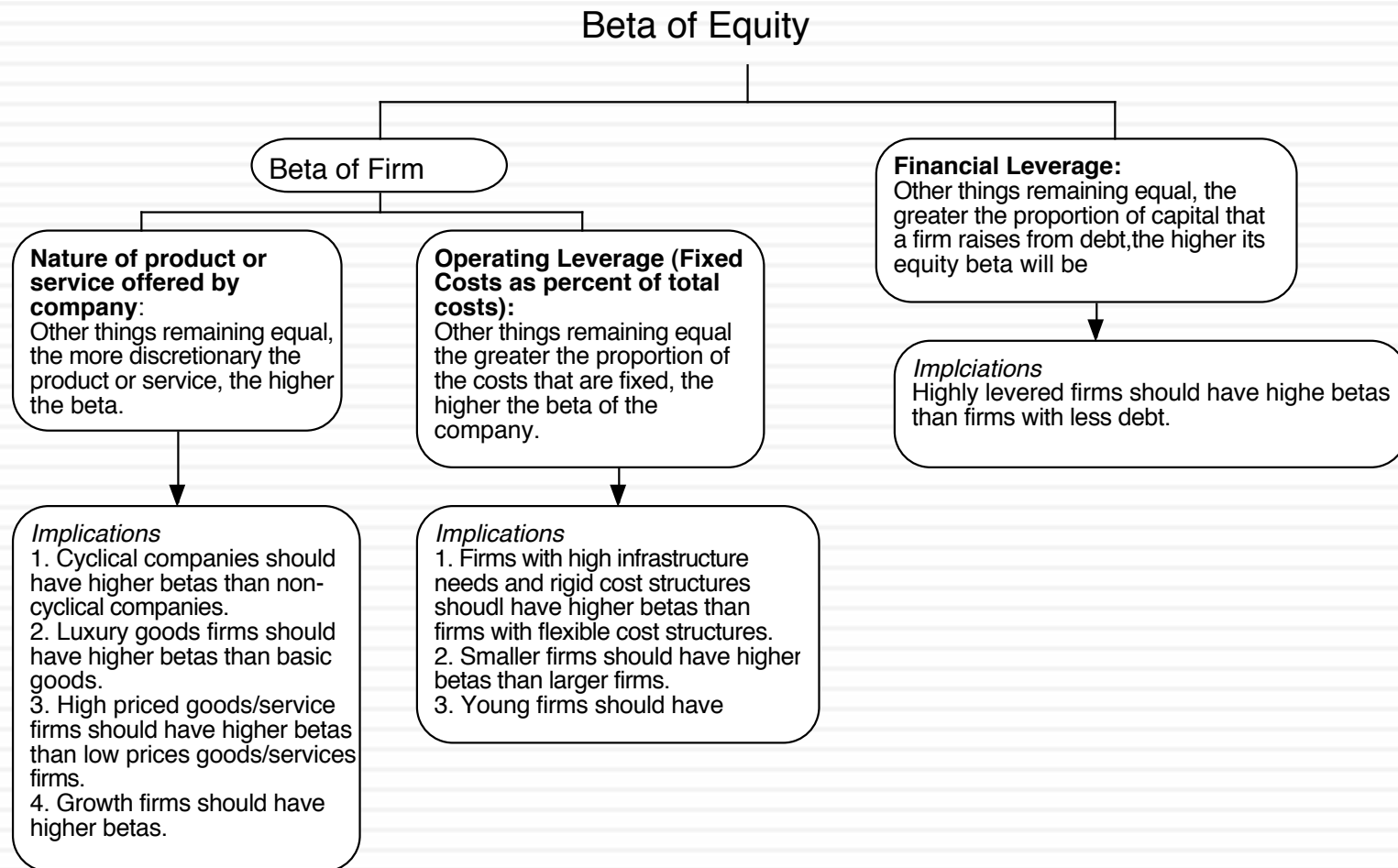

Bottom-up Betas

Step 1: Find the business or businesses that your firm operates in.

Step 2: Find publicly traded firms in each of these businesses and obtain their regression betas. Compute the simple average across these regression betas to arrive at an average beta for these publicly traded firms. Unlever this average beta using the average debt to equity ratio across the publicly traded firms in the sample.
Unlevered beta for business = Average beta across publicly traded firms / $(1 + (1-t) (\text{Average D/E ratio across firms}))$

Step 3: Estimate how much value your firm derives from each of the different businesses it is in.

Step 4: Compute a weighted average of the unlevered betas of the different businesses (from step 2) using the weights from step 3.
Bottom-up Unlevered beta for your firm = Weighted average of the unlevered betas of the individual business

Step 5: Compute a levered beta (equity beta) for your firm, using the market debt to equity ratio for your firm.
Levered bottom-up beta = Unlevered beta $(1 + (1-t) (\text{Debt/Equity}))$

Possible Refinements

If you can, adjust this beta for differences between your firm and the comparable firms on operating leverage and product characteristics.

While revenues or operating income are often used as weights, it is better to try to estimate the value of each business.

If you expect the business mix of your firm to change over time, you can change the weights on a year-to-year basis.

If you expect your debt to equity ratio to change over time, the levered beta will change over time.

Working through with our companies

□ Amgen

- The unlevered beta for pharmaceutical firms is 1.59. Using Amgen's debt to equity ratio of 11%, the bottom up beta for Amgen is
- Bottom-up Beta = $1.59 (1 + (1 - .35)(.11)) = 1.73$

□ Tata Motors

- The unlevered beta for automobile firms is 0.98. Using Tata Motor's debt to equity ratio of 33.87%, the bottom up beta for Tata Motors is
- Bottom-up Beta = $0.98 (1 + (1 - .3399)(.3387)) = 1.20$

V. And the past is not always a good indicator of the future

	Arithmetic Average		Geometric Average	
	Stocks - T. Bills	Stocks - T. Bonds	Stocks - T. Bills	Stocks - T. Bonds
1928-2014	8.00%	6.25%	6.11%	4.60%
	2.17%	2.32%		
1965-2014	6.19%	4.12%	4.84%	3.14%
	2.42%	2.74%		
2005-2014	7.94%	4.06%	6.18%	2.73%
	6.05%	8.65%		

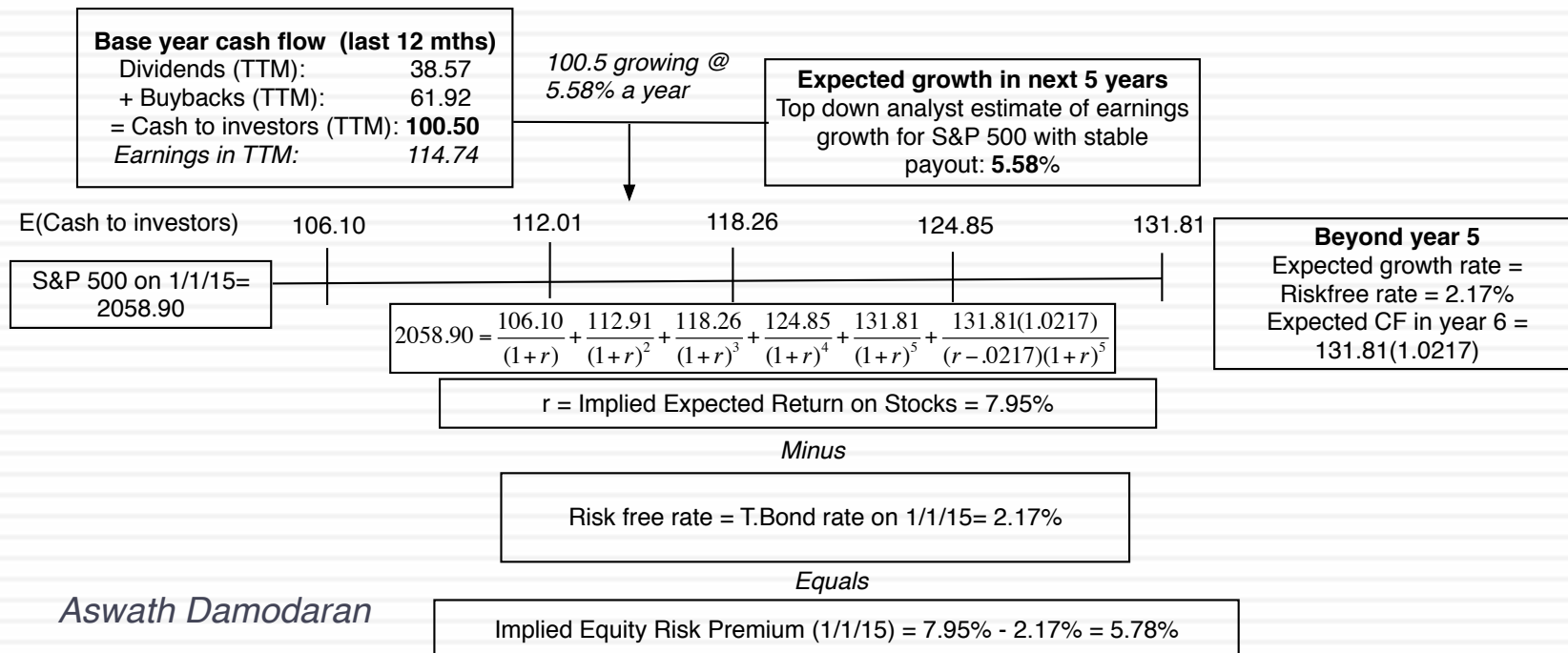

Implied Premiums in the US: 1960-2014

Implied Premium for US Equity Market: 1960-2014

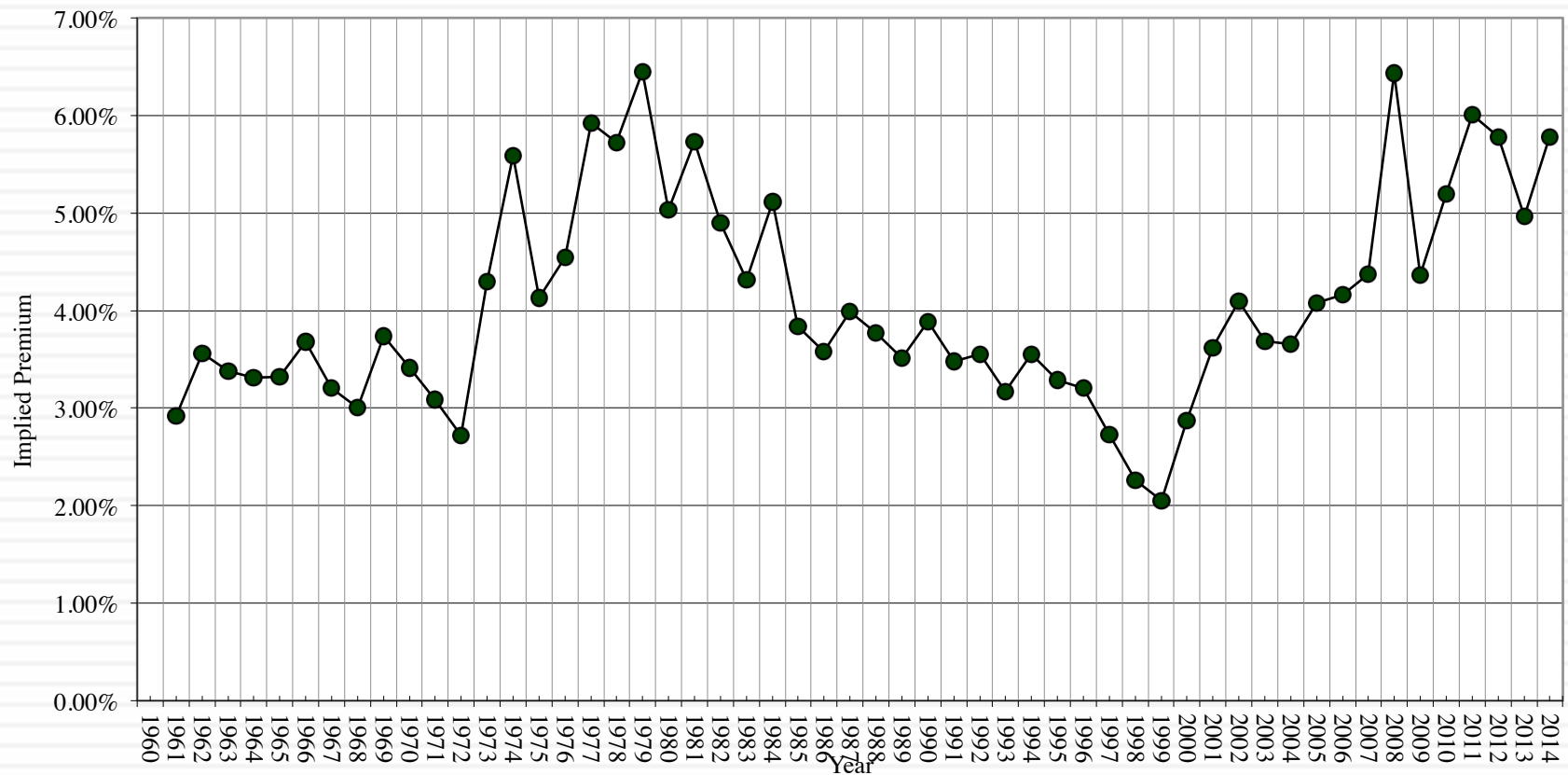

The Anatomy of a Crisis: Implied ERP from September 12, 2008 to January 1, 2009

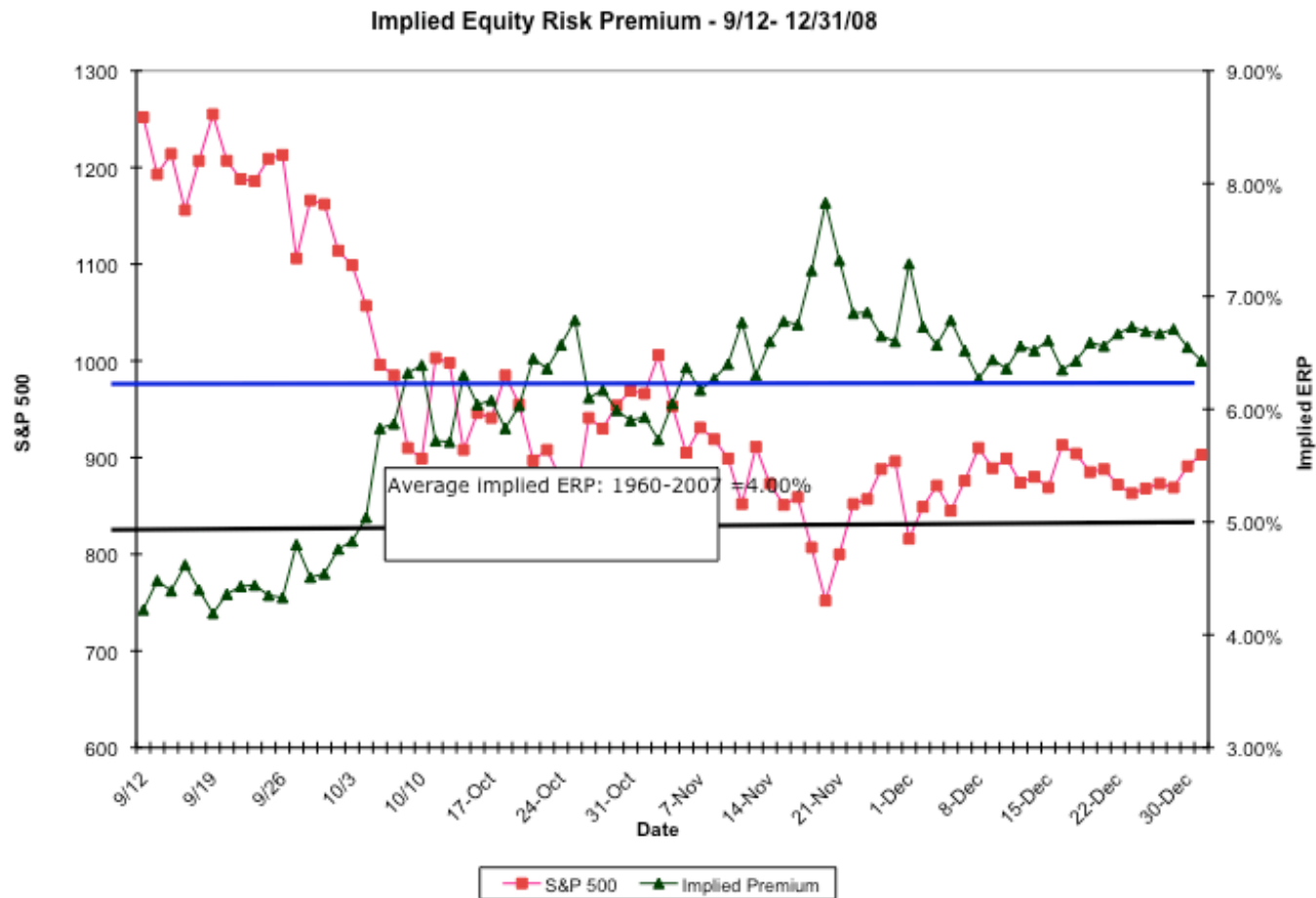

Implied Premium for India using the Sensex: April 2010

- Level of the Index = 17559
- FCFE on the Index = 3.5% (Estimated FCFE for companies in index as % of market value of equity)
- Other parameters
 - Riskfree Rate = 5% (Rupee)
 - Expected Growth (in Rupee)
 - Next 5 years = 20% (Used expected growth rate in Earnings)
 - After year 5 = 5%
- Solving for the expected return:
 - Expected return on Equity = 11.72%
 - Implied Equity premium for India = $11.72\% - 5\% = 6.72\%$

VI. There is a downside to globalization...

- Emerging markets offer growth opportunities but they are also riskier. If we want to count the growth, we have to also consider the risk.
- Two ways of estimating the country risk premium:
 - Sovereign Default Spread: In this approach, the country equity risk premium is set equal to the default spread of the bond issued by the country.
 - Equity Risk Premium for mature market = 4.50%
 - Default Spread for India = 3.00% (based on rating)
 - Equity Risk Premium for India = 4.50% + 3.00%
 - Adjusted for equity risk: The country equity risk premium is based upon the volatility of the equity market relative to the government bond rate.
 - Country risk premium = $\text{Default Spread} \times \frac{\text{Std Deviation}_{\text{Country Equity}}}{\text{Std Deviation}_{\text{Country Bond}}}$
 - Standard Deviation in Sensex = 21%
 - Standard Deviation in Indian government bond = 14%
 - Default spread on Indian Bond = 3%
 - Additional country risk premium for India = $3\% \times (21/14) = 4.5\%$

ERP : Jan 2015

Andorra	8.15%	2.40%	Italy	8.60%	2.85%
Austria	5.75%	0.00%	Jersey	6.35%	0.60%
Belgium	6.65%	0.90%	Liechtenstein	5.75%	0.00%
Cyprus	15.50%	9.75%	Luxembourg	5.75%	0.00%
Denmark	5.75%	0.00%	Malta	7.55%	1.80%
Finland	5.75%	0.00%	Netherlands	5.75%	0.00%
France	6.35%	0.60%	Norway	5.75%	0.00%
Germany	5.75%	0.00%	Portugal	9.50%	3.75%
Greece	17.00%	11.25%	Spain	8.60%	2.85%
Guernsey	6.35%	0.60%	Sweden	5.75%	0.00%
Iceland	9.05%	3.30%	Switzerland	5.75%	0.00%
Ireland	8.15%	2.40%	Turkey	9.05%	3.30%
Isle of Man	6.35%	0.60%	UK	6.35%	0.60%
			W. Europe	6.88%	1.13%

Albania	12.50%	6.75%	Montenegro	11.15%	5.40%
Armenia	10.25%	4.50%	Poland	7.03%	1.28%
Azerbaijan	9.05%	3.30%	Romania	9.05%	3.30%
Belarus	15.50%	9.75%	Russia	8.60%	2.85%
Bosnia	15.50%	.75%	Serbia	12.50%	6.75%
Bulgaria	8.60%	2.85%	Slovakia	7.03%	1.28%
Croatia	9.50%	3.75%	Slovenia	9.50%	3.75%
Czech Repub	6.80%	1.05%	Ukraine	20.75%	15.00%
Estonia	6.80%	1.05%	E. Europe	9.08%	3.33%

Canada	5.75%	0.00%
US	5.75%	0.00%
North America	5.75%	0.00%

Angola	10.25%	4.50%
Botswana	7.03%	1.28%
Burkina Faso	15.50%	9.75%
Cameroon	14.00%	8.25%
Cape Verde	14.00%	8.25%
Congo (DR)	15.50%	9.75%
Congo (Republic)	11.15%	5.40%
Côte d'Ivoire	12.50%	6.75%
Egypt	17.00%	11.25%
Ethiopia	12.50%	6.75%
Gabon	11.15%	5.40%
Ghana	14.00%	8.25%
Kenya	12.50%	6.75%
Morocco	9.50%	3.75%
Mozambique	12.50%	6.75%
Namibia	9.05%	3.30%
Nigeria	11.15%	5.40%
Rwanda	14.00%	8.25%
Senegal	12.50%	6.75%
South Africa	8.60%	2.85%
Tunisia	11.15%	5.40%
Uganda	12.50%	6.75%
Zambia	12.50%	6.75%
Africa	11.73%	5.98%

Georgia	11.15%	5.40%
Hungary	9.50%	3.75%
Kazakhstan	8.60%	2.85%
Latvia	8.15%	2.40%
Lithuania	8.15%	2.40%
Macedonia	11.15%	5.40%
Moldova	15.50%	9.75%

Abu Dhabi	6.50%	0.75%
Bahrain	8.60%	2.85%
Israel	6.80%	1.05%
Jordan	12.50%	6.75%
Kuwait	6.50%	0.75%
Lebanon	14.00%	8.25%
Oman	6.80%	1.05%
Qatar	6.50%	0.75%
Ras Al Khaimah	7.03%	1.28%
Saudi Arabia	6.65%	0.90%
Sharjah	7.55%	1.80%
UAE	6.50%	0.75%
Middle East	6.85%	1.10%

Bangladesh	11.15%	5.40%
Cambodia	14.00%	8.25%
China	6.65%	0.90%
Fiji	12.50%	6.75%
Hong Kong	6.35%	0.60%
India	9.05%	3.30%
Indonesia	9.05%	3.30%
Japan	6.80%	1.05%
Korea	6.65%	0.90%
Macao	6.50%	0.75%
Malaysia	7.55%	1.80%
Mauritius	8.15%	2.40%
Mongolia	14.00%	8.25%
Pakistan	17.00%	11.25%
Papua New Guinea	12.50%	6.75%
Philippines	8.60%	2.85%
Singapore	5.75%	0.00%
Sri Lanka	12.50%	6.75%
Taiwan	6.65%	0.90%
Thailand	8.15%	2.40%
Vietnam	12.50%	6.75%
Asia	7.26%	1.51%

Argentina	17.00%	11.25%
Belize	19.25%	13.50%
Bolivia	11.15%	5.40%
Brazil	8.60%	2.85%
Chile	6.65%	0.90%
Colombia	8.60%	2.85%
Costa Rica	9.50%	3.75%
Ecuador	15.50%	9.75%
El Salvador	11.15%	5.40%
Guatemala	9.50%	3.75%
Honduras	15.50%	9.75%
Mexico	7.55%	1.80%
Nicaragua	15.50%	9.75%
Panama	8.60%	2.85%
Paraguay	10.25%	4.50%
Peru	7.55%	1.80%
Suriname	11.15%	5.40%
Uruguay	8.60%	2.85%
Venezuela	17.00%	11.25%
Latin America	9.95%	4.20%

Black #: Total ERP
 Red #: Country risk premium
 AVG: GDP weighted average

Australia	5.75%	0.00%
Cook Islands	12.50%	6.75%
New Zealand	5.75%	0.00%
Australia & NZ	5.75%	0.00%

VII. And it is not just emerging market companies that are exposed to this risk..

- The “default” approach in valuation has been to assign country risk based upon your country of incorporation. Thus, if you are incorporated in a developed market, the assumption has been that you are not exposed to emerging market risks. If you are incorporated in an emerging market, you are saddled with the entire country risk.
- As companies globalize and look for revenues in foreign markets, this practice will under estimate the costs of equity of developed market companies with significant emerging market risk exposure and over estimate the costs of equity of emerging market companies with significant developed market risk exposure.

Globalization's flip side: Operation-based ERP

- Developed market companies are not immune from emerging market risk:

<i>Region</i>	<i>Revenues</i>	<i>Total ERP</i>	<i>CRP</i>
Western Europe	19%	6.67%	0.67%
Eastern Europe & Russia	5%	8.60%	2.60%
Asia	15%	7.63%	1.63%
Latin America	15%	9.42%	3.42%
Australia	4%	6.00%	0.00%
Africa	4%	9.82%	3.82%
North America	40%	6.00%	0.00%
Coca Cola	100%	7.14%	1.14%

- And emerging market companies are not all made equal.

	<i>Tata Motors</i>	<i>TCS</i>
% of production/operations in India	High	High
% of revenues in India	91.37% (in 2009) Estimated 70% (in 2010)	7.62%
Lambda	0.80	0.20
Flexibility in moving operations	Low. Significant physical assets.	High. Human capital is mobile.

VIII. Growth has to be earned (not endowed or estimated)

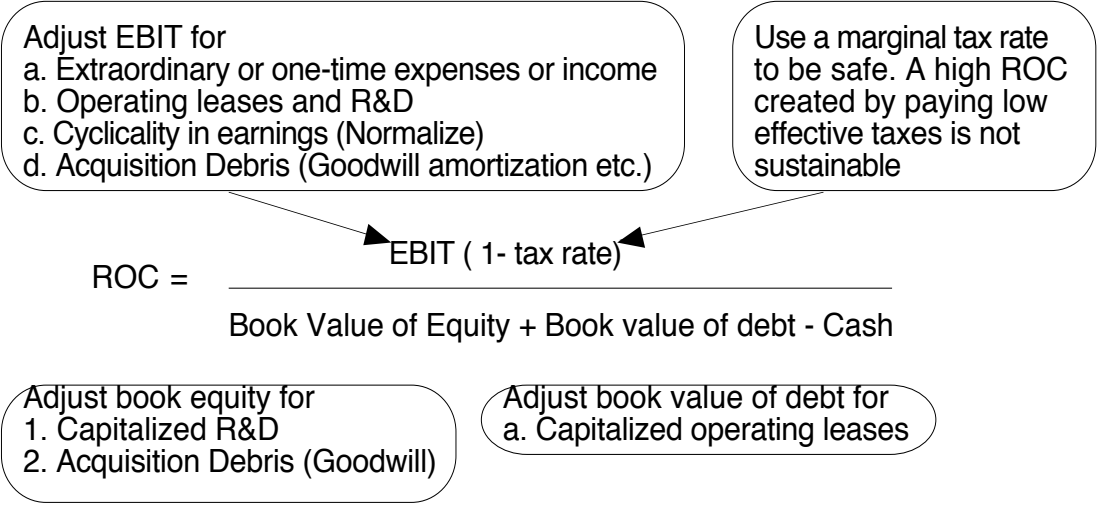
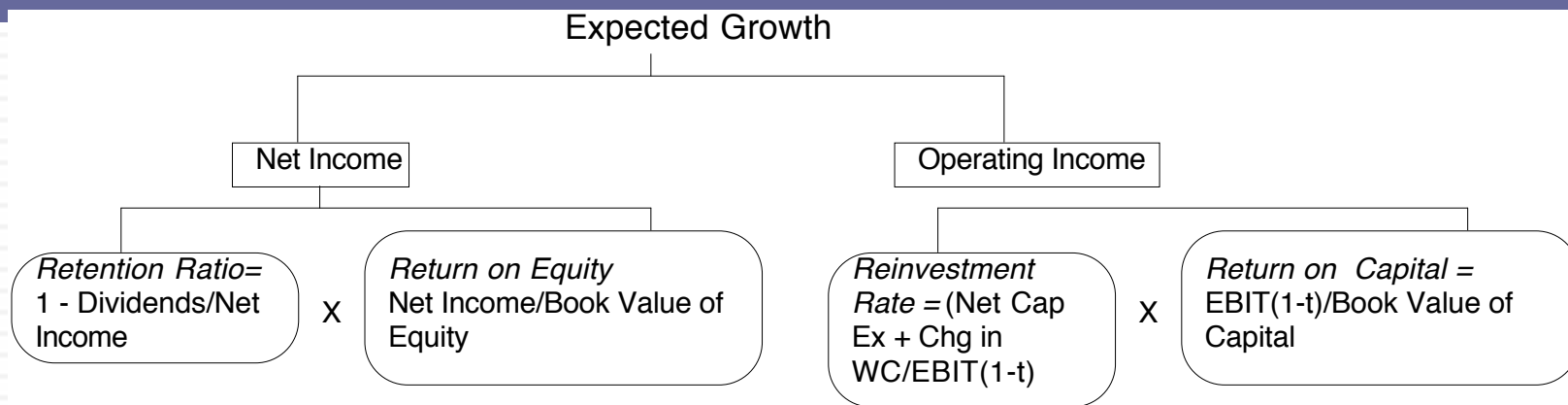

Use end of prior year numbers or average over the year but be consistent in your application

The Quality of Growth

Excess Return (ROC minus Cost of Capital) for firms with market capitalization > \$50 million: Global in 2014

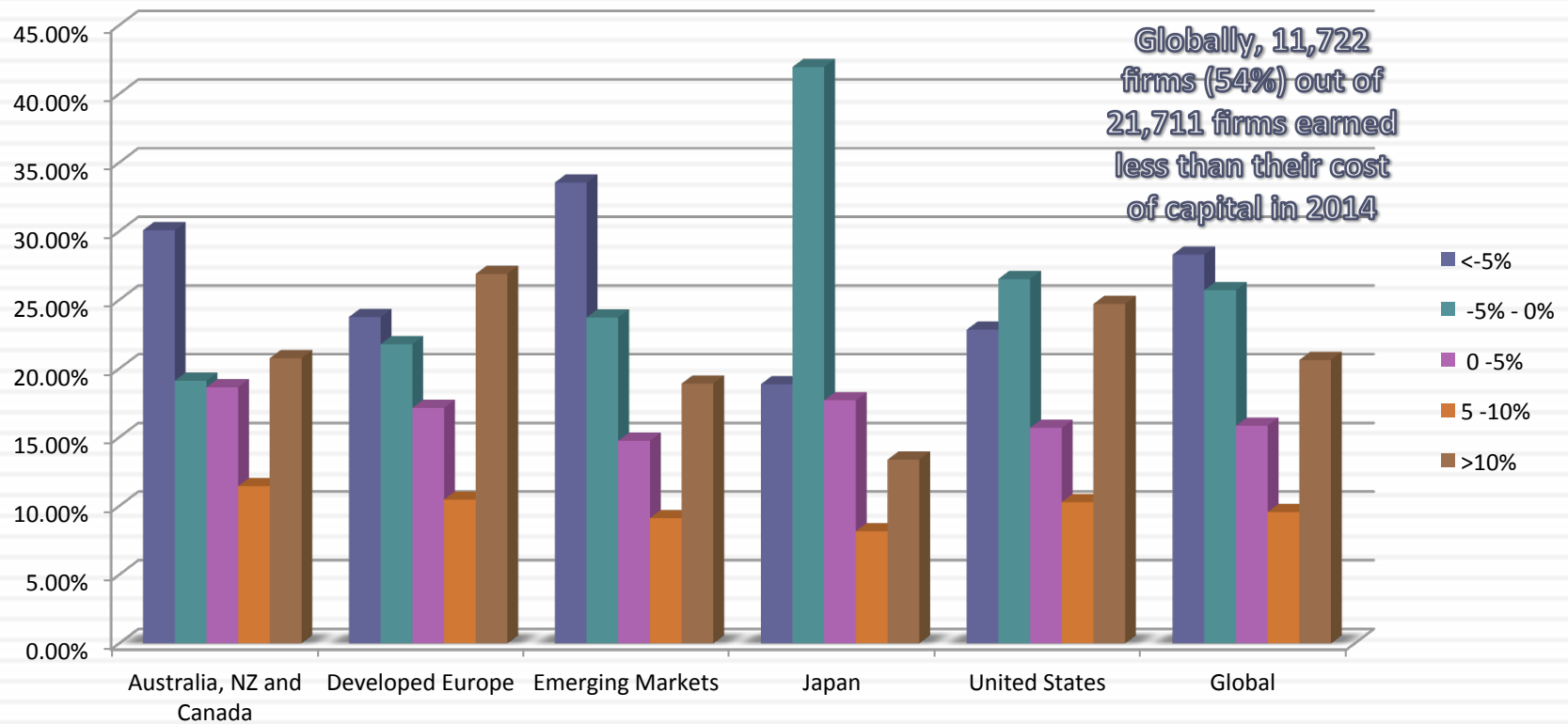

IX. All good things come to an end..And the terminal value is not an ATM...

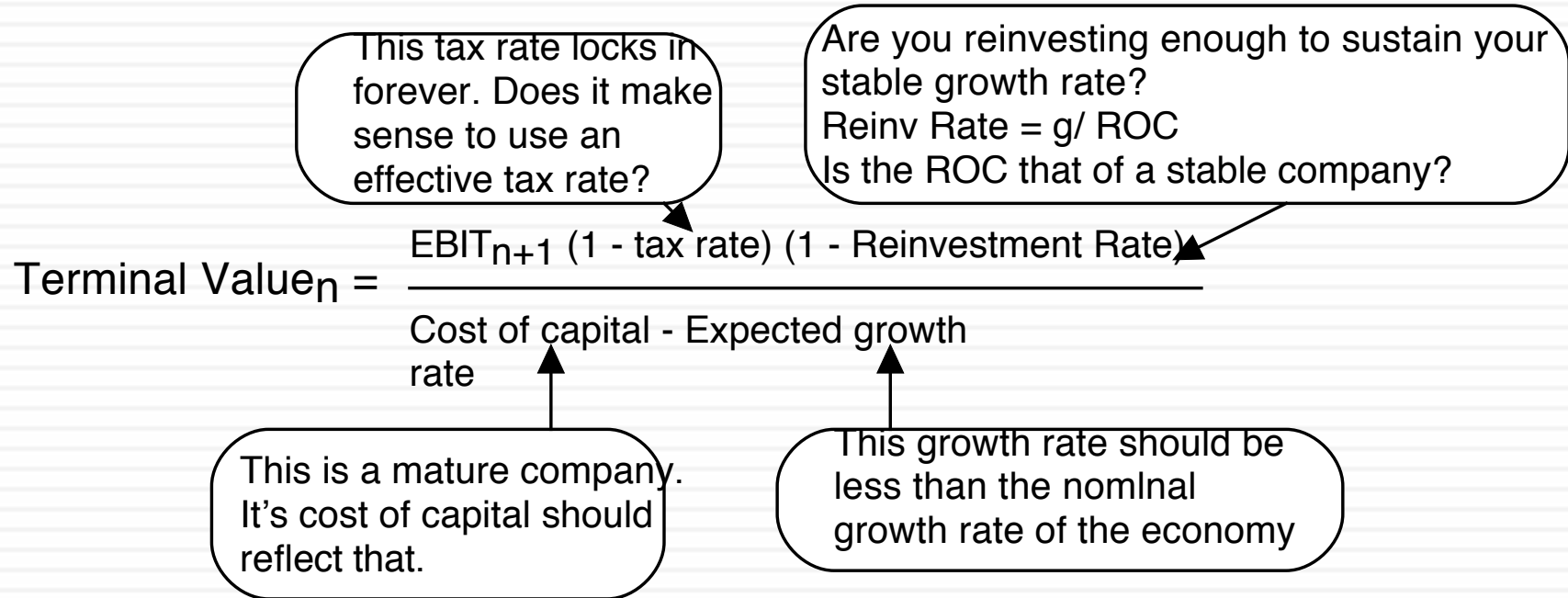

Terminal Value and Growth

<i>Stable growth rate</i>	<i>Amgen</i>	<i>Tata Motors</i>
0%	\$150,652	435,686₹
1%	\$154,479	435,686₹
2%	\$160,194	435,686₹
3%	\$167,784	435,686₹
4%	\$179,099	435,686₹
5%		435,686₹
Riskfree rate	4.78%	5%
ROIC	10%	10.39%
Cost of capital	8.08%	10.39%

Aswath Damodaran



THE LOOSE ENDS IN VALUATION...

Aswath Damodaran

Getting from DCF to value per share: The Loose Ends

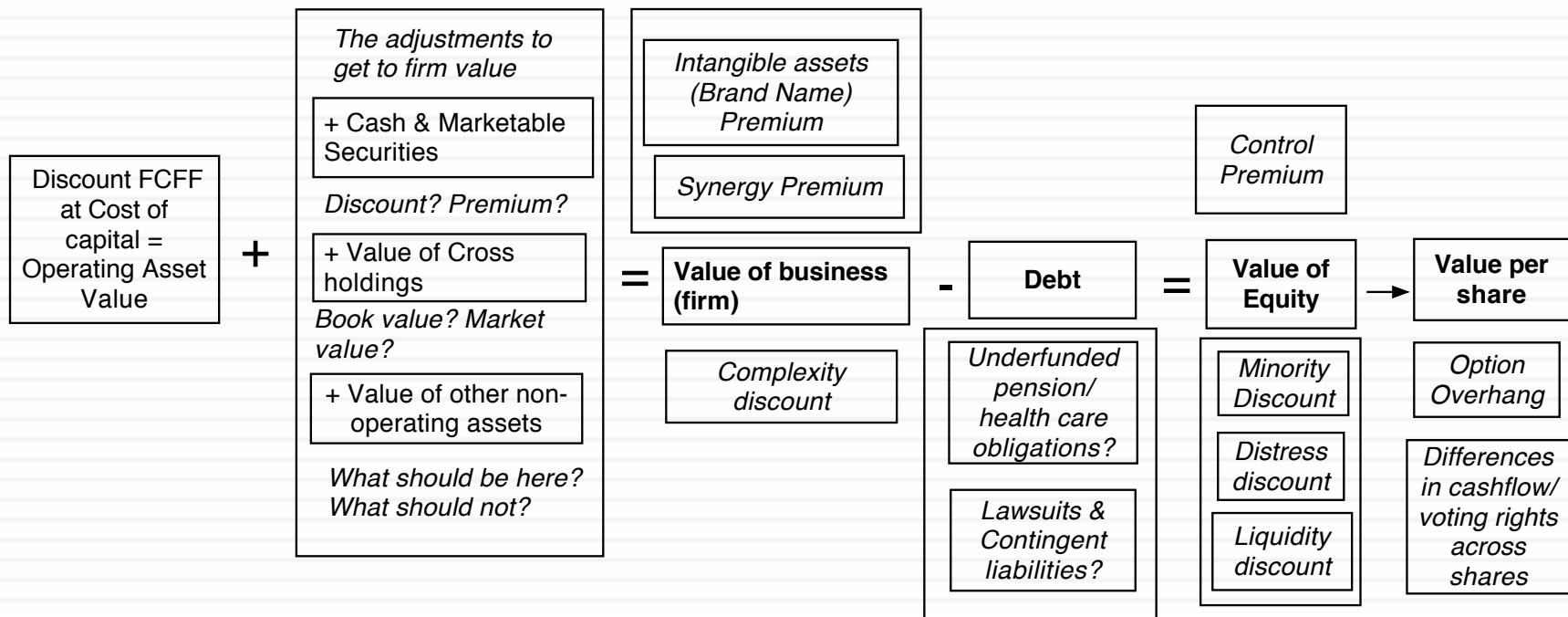

1. The Value of Cash

An Exercise in Cash Valuation

	Company A	Company B	Company C
Enterprise Value	\$ 1 billion	\$ 1 billion	\$ 1 billion
Cash	\$ 100 mil	\$ 100 mil	\$ 100 mil
Return on Capital	10%	5%	22%
Cost of Capital	10%	10%	12%
Trades in	US	US	Argentina

- In which of these companies is cash most likely to trade at face value, at a discount and at a premium?

Cash: Discount or Premium?

*Market Value of \$ 1 in cash:
Estimates obtained by regressing Enterprise Value against Cash Balances*

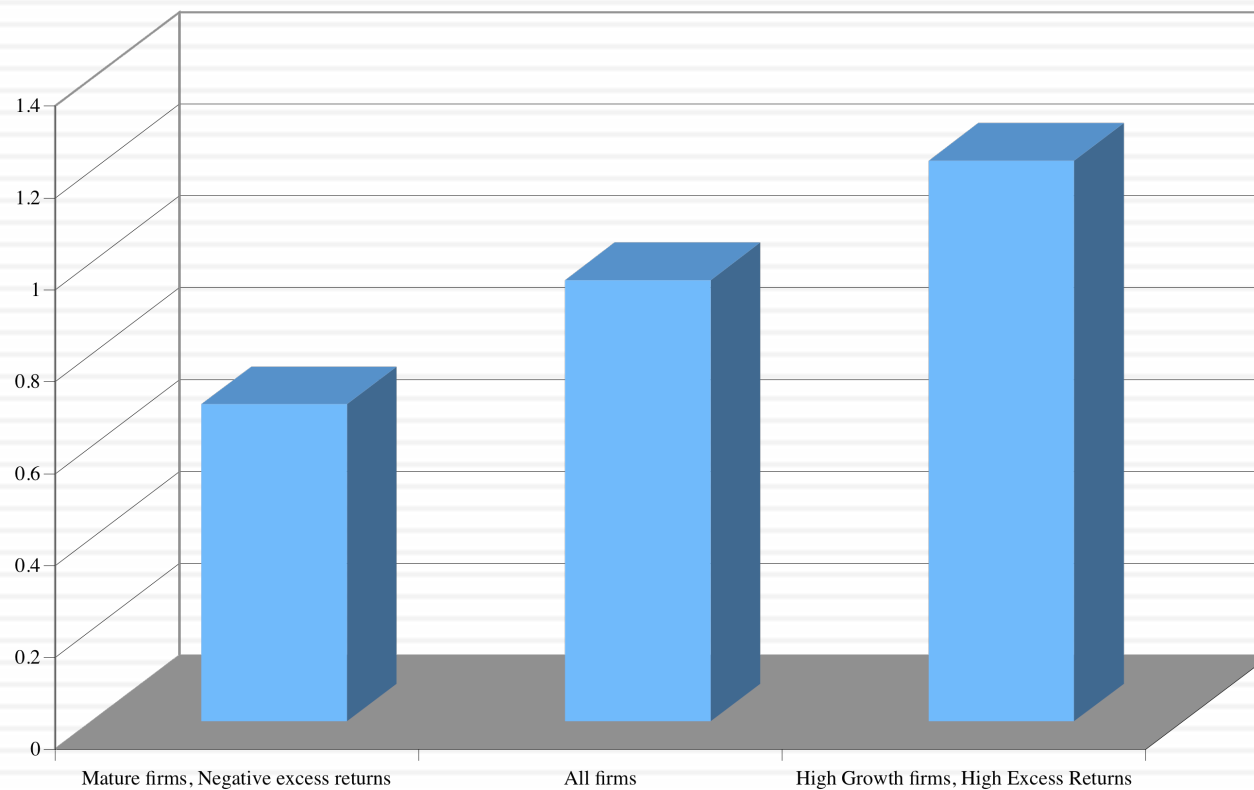

2. Dealing with Holdings in Other firms

- Holdings in other firms can be categorized into
 - ▣ Minority passive holdings, in which case only the dividend from the holdings is shown in the balance sheet
 - ▣ Minority active holdings, in which case the share of equity income is shown in the income statements
 - ▣ Majority active holdings, in which case the financial statements are consolidated.
- We tend to be sloppy in practice in dealing with cross holdings. After valuing the operating assets of a firm, using consolidated statements, it is common to add on the balance sheet value of minority holdings (which are in book value terms) and subtract out the minority interests (again in book value terms), representing the portion of the consolidated company that does not belong to the parent company.

How to value holdings in other firms.. In a perfect world..

- In a perfect world, we would strip the parent company from its subsidiaries and value each one separately. The value of the combined firm will be
 - ▣ Value of parent company + Proportion of value of each subsidiary
- To do this right, you will need to be provided detailed information on each subsidiary to estimate cash flows and discount rates.

Two compromise solutions...

- The market value solution: When the subsidiaries are publicly traded, you could use their traded market capitalizations to estimate the values of the cross holdings. You do risk carrying into your valuation any mistakes that the market may be making in valuation.
- The relative value solution: When there are too many cross holdings to value separately or when there is insufficient information provided on cross holdings, you can convert the book values of holdings that you have on the balance sheet (for both minority holdings and minority interests in majority holdings) by using the average price to book value ratio of the sector in which the subsidiaries operate.

Tata Motor's Cross Holdings

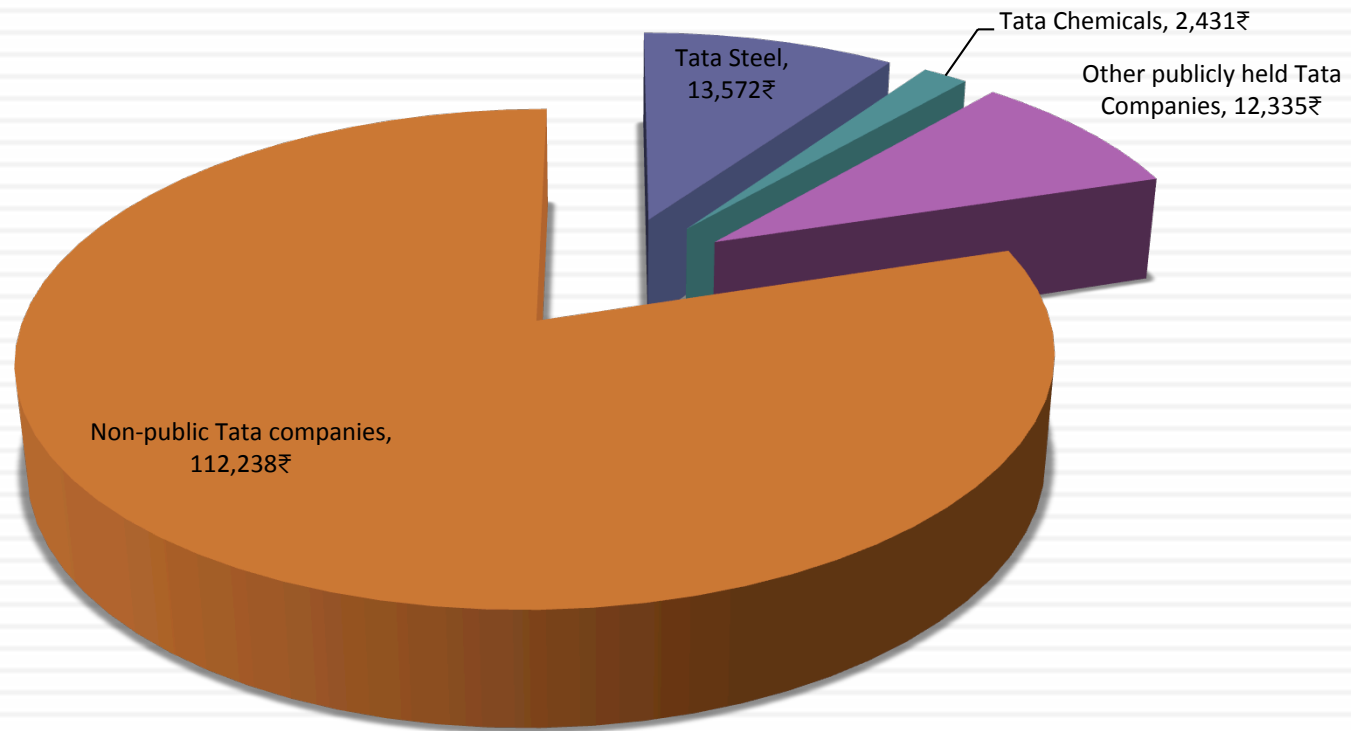

3. Other Assets that have not been counted yet..

- Unutilized assets: If you have assets or property that are not being utilized (vacant land, for example), you have not valued it yet. You can assess a market value for these assets and add them on to the value of the firm.
- Overfunded pension plans: If you have a defined benefit plan and your assets exceed your expected liabilities, you could consider the over funding with two caveats:
 - Collective bargaining agreements may prevent you from laying claim to these excess assets.
 - There are tax consequences. Often, withdrawals from pension plans get taxed at much higher rates.
- **Do not double count an asset.** If you count the income from an asset in your cash flows, you cannot count the market value of the asset in your value.

4. Brand name, great management, superb product ...Don't double count!

- There is often a temptation to add on premiums for intangibles. Here are a few examples.
 - ▣ Brand name
 - ▣ Great management
 - ▣ Loyal workforce
 - ▣ Technological prowess
- There are two potential dangers:
 - ▣ For some assets, the value may already be in your value and adding a premium will be double counting.
 - ▣ For other assets, the value may be ignored but incorporating it will not be easy.

Valuing Brand Name

	Coca Cola	With Cott Margins
Current Revenues =	\$21,962.00	\$21,962.00
Length of high-growth period	10	10
Reinvestment Rate =	50%	50%
Operating Margin (after-tax)	15.57%	5.28%
Sales/Capital (Turnover ratio)	1.34	1.34
Return on capital (after-tax)	20.84%	7.06%
Growth rate during period (g) =	10.42%	3.53%
Cost of Capital during period =	7.65%	7.65%
Stable Growth Period		
Growth rate in steady state =	4.00%	4.00%
Return on capital =	7.65%	7.65%
Reinvestment Rate =	52.28%	52.28%
Cost of Capital =	7.65%	7.65%
Value of Firm =	\$79,611.25	\$15,371.24

5. The Value of Control: It's not always worth 20%!!

- The value of the control premium that will be paid to acquire a block of equity will depend upon two factors -
 - Probability that control of firm will change: This refers to the probability that incumbent management will be replaced. this can be either through acquisition or through existing stockholders exercising their muscle.
 - Value of Gaining Control of the Company: The value of gaining control of a company arises from two sources - the increase in value that can be wrought by changes in the way the company is managed and run, and the side benefits and perquisites of being in control
 - Value of Gaining Control = Present Value (Value of Company with change in control - Value of company without change in control) + Side Benefits of Control

Increase Cash Flows

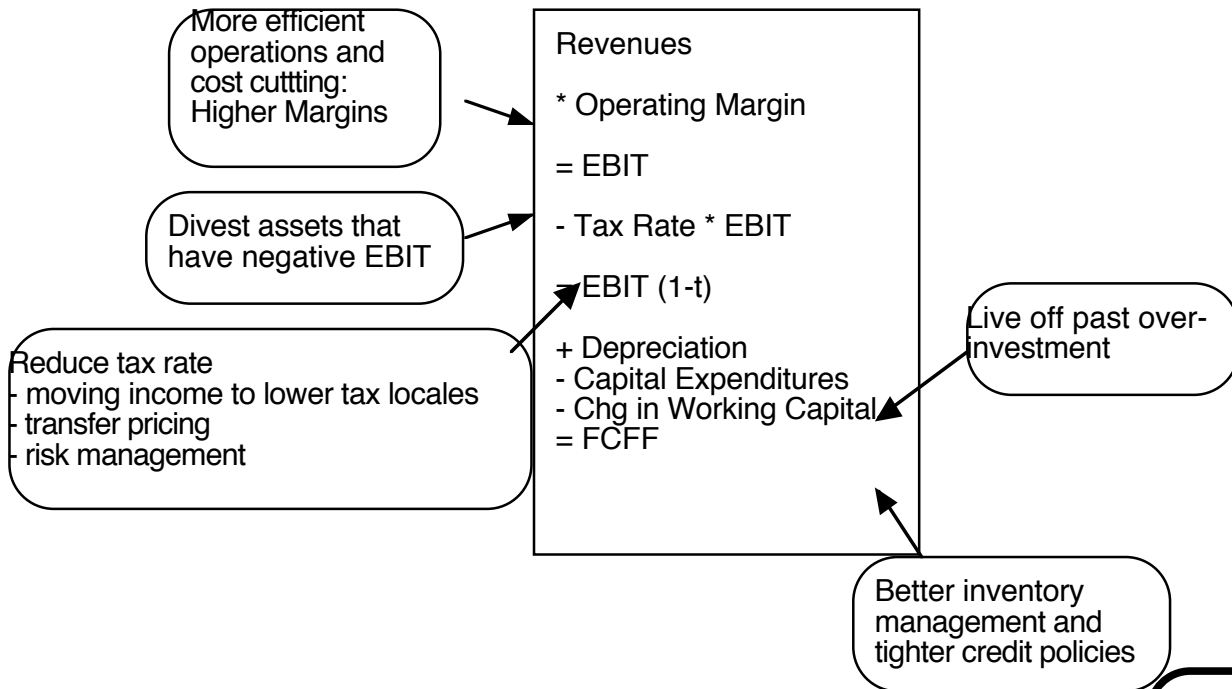

Reduce the cost of capital

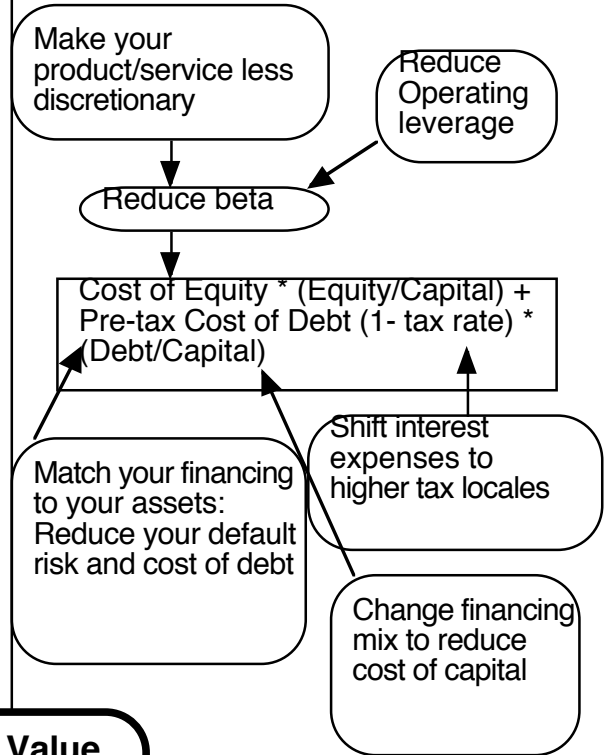

Firm Value

Increase Expected Growth

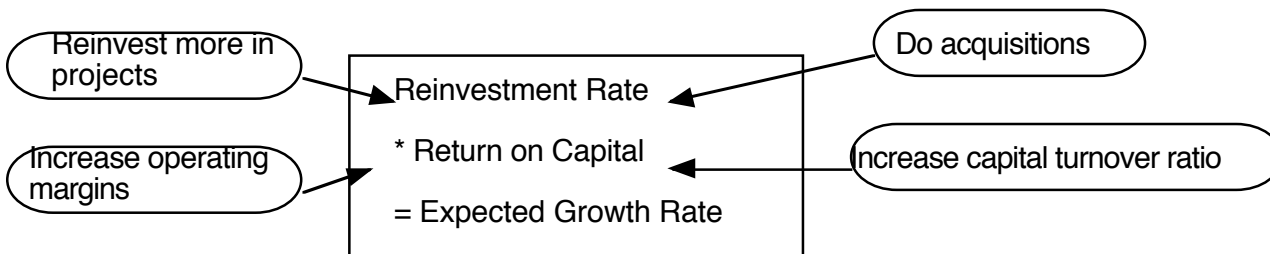

Increase length of growth period

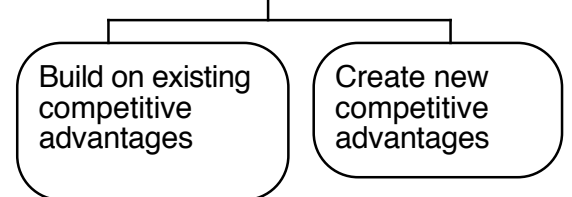

Adris Grupa (Status Quo): 4/2010

Current Cashflow to Firm
 EBIT(1-t) : 436 HRK
 - Nt CpX 3 HRK
 - Chg WC -118 HRK
 = FCFF 551 HRK
 Reinv Rate = (3-118)/436 = -26.35%;
 Tax rate = 17.35%
 Return on capital = 8.72%

Average from 2004-09
 70.83%

Reinvestment Rate
 70.83%

Expected Growth from new inv.
 $.7083 \cdot .0969 = 0.0686$
 or 6.86%

Average from 2004-09
 9.69%

Return on Capital
 9.69%

Stable Growth
 g = 4%; Beta = 0.80
 Country Premium = 2%
 Cost of capital = 9.92%
 Tax rate = 20.00%
 ROC = 9.92%;
 Reinvestment Rate = $g/ROC = 4/9.92 = 40.32\%$

Terminal Value₅ = $365 / (.0992 - .04) = 6170$ HRK

Op. Assets 4312
 + Cash: 1787
 - Debt 141
 - Minority int 465
 = Equity 5,484
 / (Common + Preferred shares)
 Value non-voting share 335 HRK/share

Year	1	2	3	4	5	
EBIT (1-t)	HRK 466	HRK 498	HRK 532	HRK 569	HRK 608	
- Reinvestment	HRK 330	HRK 353	HRK 377	HRK 403	HRK 431	
FCFF	HRK 136	HRK 145	HRK 155	HRK 166	HRK 177	
						612 246 365

Discount at \$ Cost of Capital (WACC) = 10.7% (.974) + 5.40% (0.026) = 10.55%

Cost of Equity 10.70%

Cost of Debt
 $(4.25\% + 0.5\% + 2\%)(1 - .20) = 5.40\%$

Weights
 E = 97.4% D = 2.6%

On May 1, 2010
 AG Pfd price = 279 HRK
 AG Common = 345 HRK

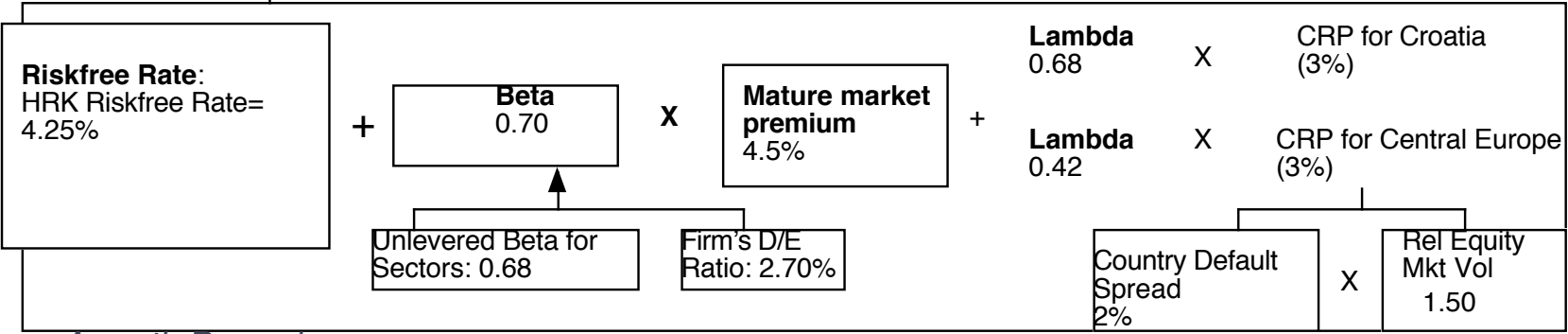

Adris Grupa: 4/2010 (Restructured)

Increased ROIC to cost of capital

Current Cashflow to Firm
 EBIT(1-t) : 436 HRK
 - Nt CpX 3 HRK
 - Chg WC -118 HRK
 = FCFF 551 HRK
 Reinv Rate = (3-118)/436 = -26.35%;
 Tax rate = 17.35%
 Return on capital = 8.72%

Average from 2004-09
70.83%

Reinvestment Rate
70.83%

Expected Growth from new inv.
 $70.83 \times 0.1054 = 0.0746$
 or 6.86%

Return on Capital
10.54%

Stable Growth
 $g = 4\%$; Beta = 0.80
 Country Premium = 2%
 Cost of capital = 9.65%
 Tax rate = 20.00%
 ROC = 9.94%;
 Reinvestment Rate = $g/ROC = 4/9.65 = 41.47\%$

Terminal Value₅ = $367 / (.0965 - .04) = 6508$ HRK

HKR Cashflows

Op. Assets 4545
 + Cash: 1787
 - Debt 141
 - Minority int 465
 = Equity 5,735

 Value/non-voting 334
 Value/voting 362

Year	1	2	3	4	5	
EBIT (1-t)	HRK 469	HRK 503	HRK 541	HRK 581	HRK 623	628
- Reinvestment	HRK 332	HRK 356	HRK 383	HRK 411	HRK 442	246
FCFF	HRK 137	HRK 147	HRK 158	HRK 169	HRK 182	367

Discount at \$ Cost of Capital (WACC) = 11.12% (.90) + 8.20% (0.10) = 10.55%

Changed mix of debt and equity to optimal

On May 1, 2010
 AG Pfd price = 279 HRK
 AG Common = 345 HRK

Cost of Equity 11.12%

Cost of Debt
 $(4.25\% + 4\% + 2\%) (1 - .20) = 8.20\%$

Weights
 E = 90 % D = 10 %

Riskfree Rate:
 HRK Riskfree Rate = 4.25%

+

Beta
0.75

x

Mature market premium
4.5%

+

Lambda
0.68

0.42

x

x

CRP for Croatia (3%)

CRP for Central Europe (3%)

Unlevered Beta for Sectors: 0.68

Firm's D/E Ratio: 11.1%

Country Default Spread 2%

x

Rel Equity Mkt Vol 1.50

Value of Control and the Value of Voting Rights

- Adris Grupa has two classes of shares outstanding: 9.616 million voting shares and 6.748 million non-voting shares.
- To value a non-voting share, we assume that all non-voting shares essentially have to settle for status quo value. All shareholders, common and preferred, get an equal share of the status quo value.

Status Quo Value of Equity = 5,484 million HKR

Value for a non-voting share = $5484 / (9.616 + 6.748) = 334$ HKR/share

- To value a voting share, we first value control in Adris Grup as the difference between the optimal and the status quo value:

Value of control at Adris Grupa = $5,735 - 5484 = 249$ million HKR

Value per voting share = $334 \text{ HKR} + 249 / 9.616 = 362$ HKR

Aswath Damodaran



THE DARK SIDE OF VALUATION: VALUING DIFFICULT-TO-VALUE COMPANIES



The Dark Side of Valuation...

- Valuing stable, money making companies with consistent and clear accounting statements, a long and stable history and lots of comparable firms is easy to do.
- The true test of your valuation skills is when you have to value “difficult” companies. In particular, the challenges are greatest when valuing:
 - Young companies, early in the life cycle, in young businesses
 - Companies that don’t fit the accounting mold
 - Companies that face substantial truncation risk (default or nationalization risk)

I. The challenge with young companies...

Figure 5.2: Estimation Issues - Young and Start-up Companies

Making judgments on revenues/ profits difficult because you cannot draw on history. If you have no product/ service, it is difficult to gauge market potential or profitability. The company's entire value lies in future growth but you have little to base your estimate on.

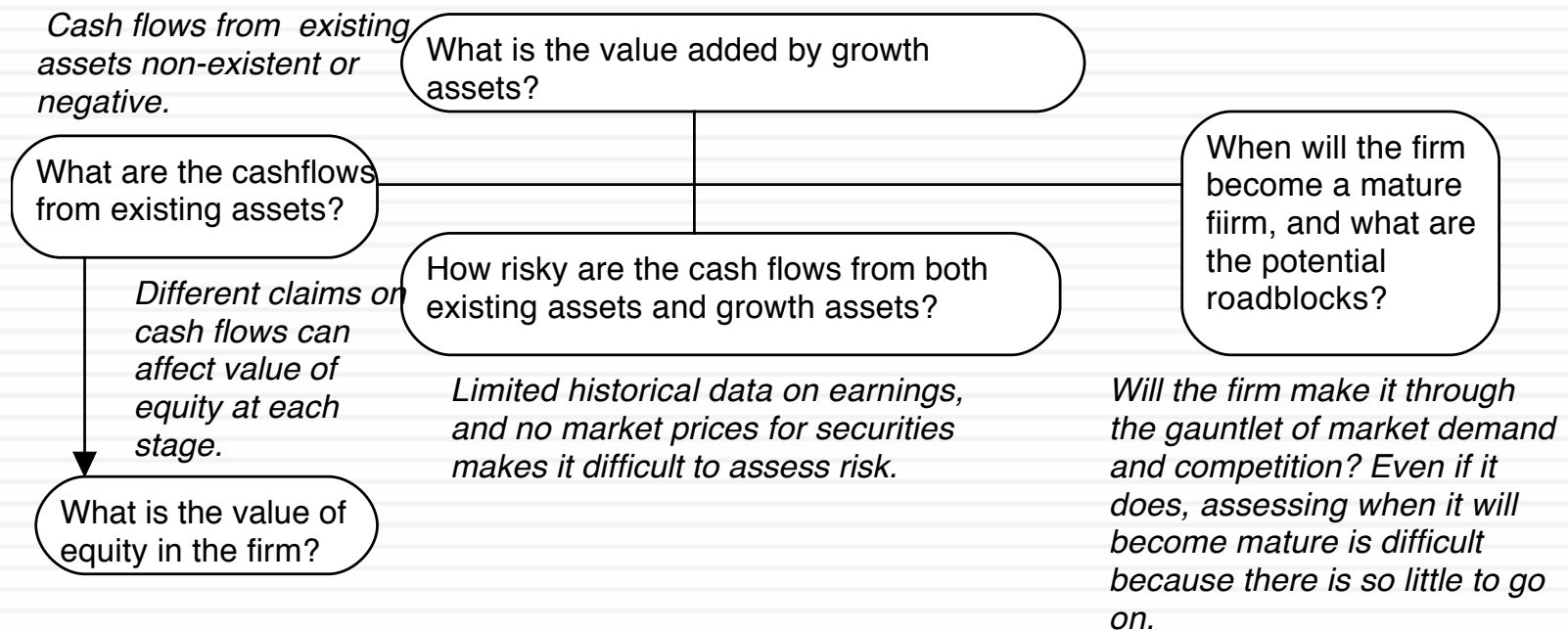

Upping the ante.. Young companies in young businesses...

- When valuing a business, we generally draw on three sources of information
 - ▣ The firm's current financial statement
 - How much did the firm sell?
 - How much did it earn?
 - ▣ The firm's financial history, usually summarized in its financial statements.
 - How fast have the firm's revenues and earnings grown over time?
 - What can we learn about cost structure and profitability from these trends?
 - Susceptibility to macro-economic factors (recessions and cyclical firms)
 - ▣ The industry and comparable firm data
 - What happens to firms as they mature? (Margins.. Revenue growth... Reinvestment needs... Risk)
- It is when valuing these companies that you find yourself tempted by the dark side, where
 - ▣ "Paradigm shifts" happen...
 - ▣ New metrics are invented ...
 - ▣ The story dominates and the numbers lag...

Amazon in January 2000

Sales to capital ratio and expected margin are retail industry average numbers

Stable Growth

Stable Revenue Growth: 6%	Stable Operating Margin: 10.00%	Stable ROC=20% Reinvest 30% of EBIT(1-t)
---------------------------	---------------------------------	---

From previous years

Current Revenue: \$ 1,117	Current Margin: -36.71%
EBIT: -410m	
NOL: 500 m	

Sales Turnover Ratio: 3.00	Competitive Advantages
Revenue Growth: 42%	Expected Margin: -> 10.00%

Terminal Value = $1881 / (.0961 - .06) = 52,148$

Value of Op Assets \$ 15,170
 + Cash \$ 26
 = Value of Firm \$15,196
 - Value of Debt \$ 349
 = Value of Equity \$14,847
 - Equity Options \$ 2,892
 Value per share \$ 35.08

	1	2	3	4	5	6	7	8	9	10	Term. Year
Revenue Growth	150.00%	100.00%	75.00%	50.00%	30.00%	25.20%	20.40%	15.60%	10.80%	6.00%	6%
Revenues	\$ 2,793	\$ 5,585	\$ 9,774	\$ 14,661	\$ 19,059	\$ 23,862	\$ 28,729	\$ 33,211	\$ 36,798	\$ 39,006	\$ 41,346
Operating Margin	-13.35%	-1.68%	4.16%	7.08%	8.54%	9.27%	9.64%	9.82%	9.91%	9.95%	10.00%
EBIT	-\$373	-\$94	\$407	\$1,038	\$1,628	\$2,212	\$2,768	\$3,261	\$3,646	\$3,883	\$4,135
EBIT(1-t)	-\$373	-\$94	\$407	\$871	\$1,058	\$1,438	\$1,799	\$2,119	\$2,370	\$2,524	\$2,688
- Reinvestment	\$600	\$967	\$1,420	\$1,663	\$1,543	\$1,688	\$1,721	\$1,619	\$1,363	\$961	\$155
FCFF	-\$931	-\$1,024	-\$989	-\$758	-\$408	-\$163	\$177	\$625	\$1,174	\$1,788	\$1,881

All existing options valued as options, using current stock price of \$84.

	1	2	3	4	5	6	7	8	9	10	Forever
Cost of Equity	12.90%	12.90%	12.90%	12.90%	12.90%	12.42%	11.94%	11.46%	10.98%	10.50%	
Cost of Debt	8.00%	8.00%	8.00%	8.00%	8.00%	7.80%	7.75%	7.67%	7.50%	7.00%	
After-tax cost of debt	8.00%	8.00%	8.00%	6.71%	5.20%	5.07%	5.04%	4.98%	4.88%	4.55%	
Cost of Capital	12.84%	12.84%	12.84%	12.83%	12.81%	12.13%	11.62%	11.08%	10.49%	9.61%	

Cost of Equity 12.90%

Used average interest coverage ratio over next 5 years to get BBB rating.

Cost of Debt 6.5%+1.5%=8.0%
 Tax rate = 0% -> 35%

Weights Debt= 1.2% -> 15%

Amazon was trading at \$84 in January 2000.

Pushed debt ratio to retail industry average of 15%.

Riskfree Rate: T. Bond rate = 6.5%

+ **Beta 1.60 -> 1.00** X **Risk Premium 4%**

Dot.com retailers for first 5 years
 Conventional retailers after year 5

Internet/Retail	Operating Leverage	Current D/E: 1.21%	Base Equity Premium	Country Risk Premium
-----------------	--------------------	--------------------	---------------------	----------------------

Starting numbers

	Last 10K	Trailing 12 month
Revenues	\$316.93	\$534.46
Operating income	-\$77.06	-\$134.91
Adjusted Operating Income		\$7.67
Invested Capital		\$955.00
Adjusted Operatng Margin		1.44%
Sales/ Invested Capital		0.56
Interest expenses	\$2.49	\$5.30

Twitter Pre-IPO Valuation: October 27, 2013

Revenue growth of 51.5% a year for 5 years, tapering down to 2.5% in year 10

Pre-tax operating margin increases to 25% over the next 10 years

Sales to capital ratio of 1.50 for incremental sales

Stable Growth
 g = 2.5%; Beta = 1.00;
 Cost of capital = 8%
 ROC = 12%;
 Reinvestment Rate = 2.5%/12% = 20.83%

Terminal Value₁₀ = 1466 / (.08 - .025) = \$26,657

	1	2	3	4	5	6	7	8	9	10
Revenues	\$ 810	\$1,227	\$1,858	\$2,816	\$4,266	\$6,044	\$7,973	\$9,734	\$10,932	\$11,205
Operating Income	\$ 31	\$ 75	\$ 158	\$ 306	\$ 564	\$ 941	\$1,430	\$1,975	\$ 2,475	\$ 2,801
Operating Income after tax	\$ 31	\$ 75	\$ 158	\$ 294	\$ 395	\$ 649	\$ 969	\$1,317	\$ 1,624	\$ 1,807
- Reinvestment	\$ 183	\$ 278	\$ 421	\$ 638	\$ 967	\$1,186	\$1,285	\$1,175	\$ 798	\$ 182
FCFF	\$(153)	\$(203)	\$(263)	\$(344)	\$(572)	\$(537)	\$(316)	\$ 143	\$ 826	\$ 1,625

Terminal year (11)

EBIT (1-t)	\$ 1,852
- Reinvestment	\$ 386
FCFF	\$ 1,466

Operating assets	\$9,705
+ Cash	321
+ IPO Proceeds	1295
- Debt	214
Value of equity	11,106
- Options	713
Value in stock	10,394
/ # of shares	582.46
Value/share	\$17.84

Cost of capital = 11.12% (.981) + 5.16% (.019) = 11.01%

Cost of capital decreases to 8% from years 6-10

Cost of Equity
11.12%

Cost of Debt
(2.5% + 5.5%)(1 - .40)
= 5.16%

Weights
E = 98.1% D = 1.9%

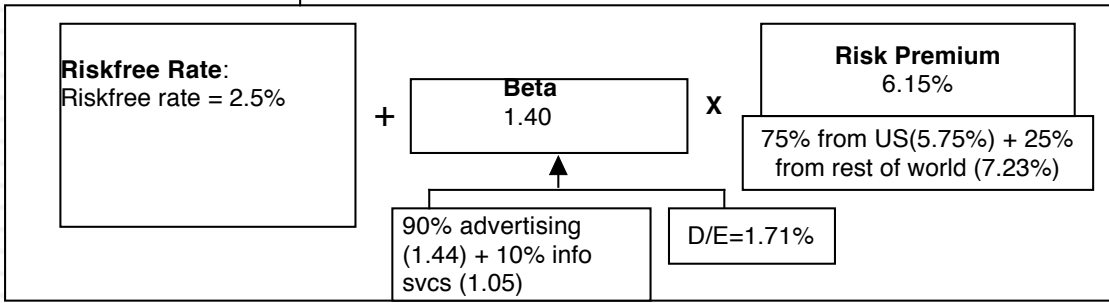

Lesson 1: Have a narrative

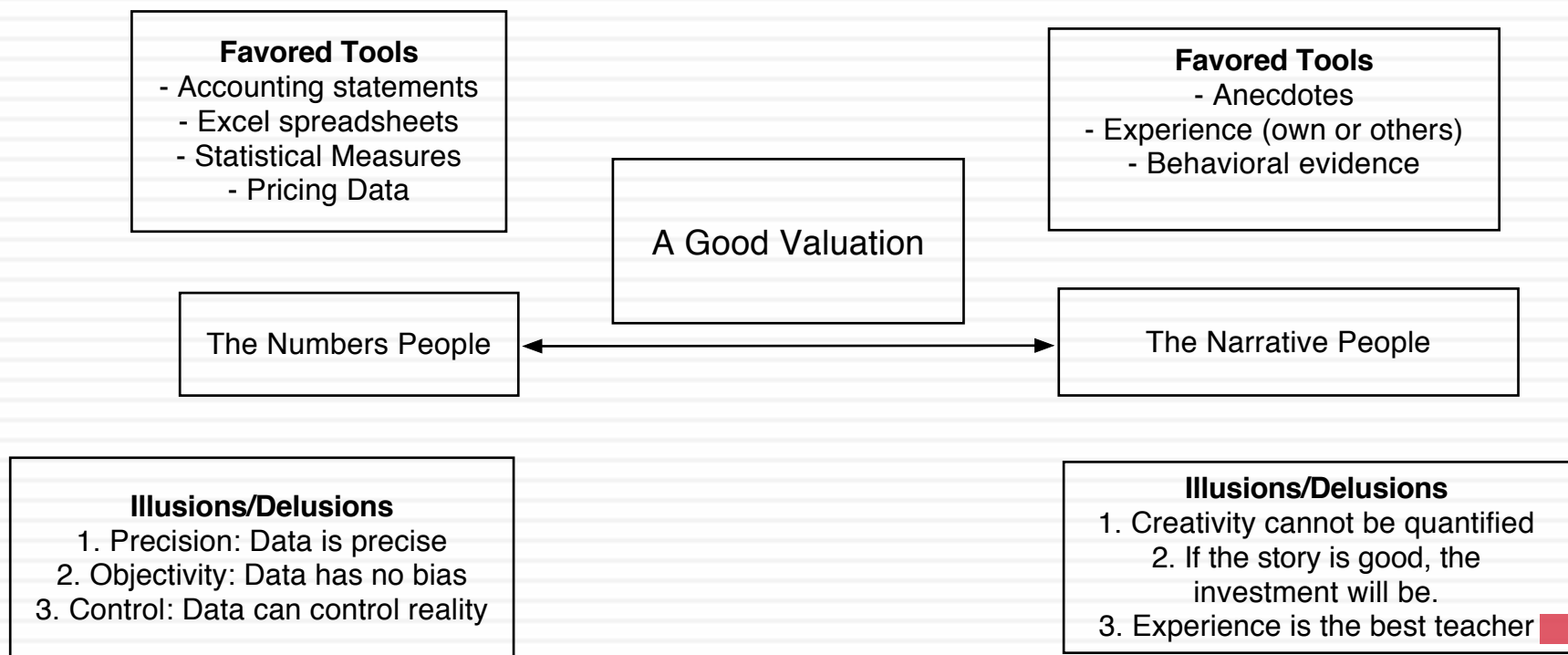

Your narrative and counters

- *My narrative for Uber:* Uber will expand the car service market moderately, primarily in urban environments, and use its competitive advantages to get a significant but not dominant market share and maintain its profit margins.
- *Bill Gurley's counter narrative*
 - Not just car service company.: Uber is a car company, not just a car service company, and there may be a day when consumers will subscribe to a Uber service, rather than own their own cars. It could also expand into logistics, i.e., moving and transportation businesses.
 - Not just urban: Uber can create new demands for car service in parts of the country where taxis are not used (suburbia, small towns).
 - Global networking benefits: By linking with technology and credit card companies, Uber can have global networking benefits.

The narrative to numbers

<i>Step</i>	<i>Narrative</i>	<i>Numbers</i>
1	<p><i>What market(s) is (are) Uber's products targeting?</i></p> <ul style="list-style-type: none"> a. Is Uber just a car service company? b. If not, what other markets do you see Uber competing in? 	<p><i>Potential Market</i></p> <p>This sets the limits of growth for the company, and the more broadly defined the market, the larger the potential growth (and the higher the value).</p>
2	<p><i>How will Uber & like products affect market growth?</i></p> <ul style="list-style-type: none"> a. Given the potential market defined in step 1, how many new users will Uber & like products/services attract into the market? b. What effect will these new users have on overall market growth? 	<p><i>Potential Market Growth</i></p> <p>The more new users that a company attracts into the market, the higher the expected growth rate in that market.</p>
3	<p><i>Will Uber derive any network benefits as it grows?</i></p> <ul style="list-style-type: none"> a. As Uber grows in an existing market, will that make further growth in that market easier (local network effects)? b. If Uber goes into a new market, how much does success in existing markets help it? (global network effects) 	<p><i>Market Share</i></p> <p>If there are no network effects in the market, it will stay splintered with no company claiming a significant market share. If there are only local network effects, multiple companies will get significant market shares, but none will be dominant. With global network effects, a company will be able to get a dominant market share.</p>
4	<p><i>What are Uber's competitive advantages?</i></p> <ul style="list-style-type: none"> a. What are Uber's competitive advantages over existing competitors? b. Will these competitive advantages hold up as the market growth (and new competitors enter)? 	<p><i>Cut of gross receipts & Operating Costs</i></p> <p>The slice of revenue that Uber claims of the gross receipts (on cab rides, local delivery etc.) will depend on how strong and sustainable its competitive advantages are, with stronger/more sustainable advantages going along with larger slices of revenues/higher operating margins.</p>
5	<p><i>What will Uber have to invest to generate growth?</i></p> <ul style="list-style-type: none"> a. Will Uber continue with its existing model (low capital intensity) as it grows? b. Will the growth be organic or acquired? 	<p><i>Reinvestment</i></p> <p>The more Uber will have to invest to generate new growth, the less cash flow will be left over for investors (and the lower the value).</p>
6	<p><i>How risky is Uber as an investment?</i></p> <ul style="list-style-type: none"> a. How much risk is there in Uber's operating businesses? b. What is the chance that Uber will not survive? 	<p><i>Risk Adjustment</i></p> <p>The higher the risk in the operating businesses, the higher will be the rate of return (cost of capital) you demand for investing in the company. If failure risk is high, the value will be adjusted down even further.</p>

Lesson 2: Less is more

63

Year	Revenue Growth	Sales	Operating Margin	EBIT	EBIT (1-t)
Tr 12 mths		\$1,117	-36.71%	-\$410	-\$410
1	150.00%	\$2,793	-13.35%	-\$373	-\$373
2	100.00%	\$5,585	-1.68%	-\$94	-\$94
3	75.00%	\$9,774	4.16%	\$407	\$407
4	50.00%	\$14,661	7.08%	\$1,038	\$871
5	30.00%	\$19,059	8.54%	\$1,628	\$1,058
6	25.20%	\$23,862	9.27%	\$2,212	\$1,438
7	20.40%	\$28,729	9.64%	\$2,768	\$1,799
8	15.60%	\$33,211	9.82%	\$3,261	\$2,119
9	10.80%	\$36,798	9.91%	\$3,646	\$2,370
10	6.00%	\$39,006	9.95%	\$3,883	\$2,524
TY	6.00%	\$41,346	10.00%	\$4,135	\$2,688

Principle of parsimony: Estimate fewer inputs when faced with uncertainty.

Use “auto pilot” approaches to estimate future years

A tougher task at Twitter

64

	2011		2012		2013	
	%	\$	%	\$	%	\$
Google	32.09%	\$27.74	31.46%	\$32.73	33.24%	\$38.83
Facebook	3.65%	\$3.15	4.11%	\$4.28	5.04%	\$5.89
Yahoo!	3.95%	\$3.41	3.37%	\$3.51	3.10%	\$3.62
Microsoft	1.27%	\$1.10	1.63%	\$1.70	1.78%	\$2.08
IAC	1.15%	\$0.99	1.39%	\$1.45	1.47%	\$1.72
AOL	1.17%	\$1.01	1.02%	\$1.06	0.95%	\$1.11
Amazon	0.48%	\$0.41	0.59%	\$0.61	0.71%	\$0.83
Pandora	0.28%	\$0.24	0.36%	\$0.37	0.50%	\$0.58
Twitter	0.16%	\$0.14	0.28%	\$0.29	0.50%	\$0.58
Linkedin	0.18%	\$0.16	0.25%	\$0.26	0.32%	\$0.37
Millennial Media	0.05%	\$0.04	0.07%	\$0.07	0.10%	\$0.12
Other	55.59%	\$48.05	55.47%	\$57.71	52.29%	\$61.09
Total Market	100%	\$86.43	100.00%	\$104.04	100.00%	\$116.82

Company	Operating Margin
Google Inc. (NasdaqGS:GOOG)	22.82%
Facebook, Inc. (NasdaqGS:FB)	29.99%
Yahoo! Inc. (NasdaqGS:YHOO)	13.79%
Netfix	3.16%
Groupon	2.53%
LinkedIn Corporation (NYSE:LNKD)	5.18%
Pandora Media, Inc. (NYSE:P)	-9.13%
Yelp, Inc. (NYSE:YELP)	-6.19%
OpenTable, Inc. (NasdaqGS:OPEN)	24.90%
RetailMeNot	45.40%
Travelzoo Inc. (NasdaqGS:TZOO)	15.66%
Zillow, Inc. (NasdaqGS:Z)	-66.60%
Trulia, Inc. (NYSE:TRLA)	-6.79%
Aggregate	20.40%

		Annual growth rate in Global Advertising Spending				
		2.00%	2.50%	3.00%	3.50%	4.00%
Online advertising share of market	20%	\$124.78	\$131.03	\$137.56	\$144.39	\$151.52
	25%	\$155.97	\$163.79	\$171.95	\$180.49	\$189.40
	30%	\$187.16	\$196.54	\$206.34	\$216.58	\$227.28
	35%	\$218.36	\$229.30	\$240.74	\$252.68	\$265.16
	40%	\$249.55	\$262.06	\$275.13	\$288.78	\$303.04

My estimate for 2023: Overall market will be close to \$200 billion and Twitter will about 5.7% (\$11.5 billion)

Aswath Damodaran

*My estimate for Twitter:
Operating margin of 25% in year 10*

Lesson 3: Build in “internal” checks for reasonableness...

65

Year	Revenues	Δ Revenue	Sales/Cap	Δ Investment	Invested Capital	EBIT (1-t)	Imputed ROC
Tr 12 mths	\$1,117				\$ 487	-\$410	
1	\$2,793	\$1,676	3.00	\$559	\$ 1,045	-\$373	-76.62%
2	\$5,585	\$2,793	3.00	\$931	\$ 1,976	-\$94	-8.96%
3	\$9,774	\$4,189	3.00	\$1,396	\$ 3,372	\$407	20.59%
4	\$14,661	\$4,887	3.00	\$1,629	\$ 5,001	\$871	25.82%
5	\$19,059	\$4,398	3.00	\$1,466	\$ 6,467	\$1,058	21.16%
6	\$23,862	\$4,803	3.00	\$1,601	\$ 8,068	\$1,438	22.23%
7	\$28,729	\$4,868	3.00	\$1,623	\$ 9,691	\$1,799	22.30%
8	\$33,211	\$4,482	3.00	\$1,494	\$ 11,185	\$2,119	21.87%
9	\$36,798	\$3,587	3.00	\$1,196	\$ 12,380	\$2,370	21.19%
10	\$39,006	\$2,208	3.00	\$736	\$ 13,116	\$2,524	20.39%
TY	\$41,346	\$2,340	NA		Assumed to be =		20.00%

*Check total revenues, relative to the market that it serves...
Your market share obviously cannot exceed 100% but there may be tighter constraints.*

Are the margins and imputed returns on capital ‘reasonable’ in the outer years?

Lesson 4: Scaling up is hard to do...

Typically, the revenue growth rate of a newly public company outpaces its industry average for only about five years.

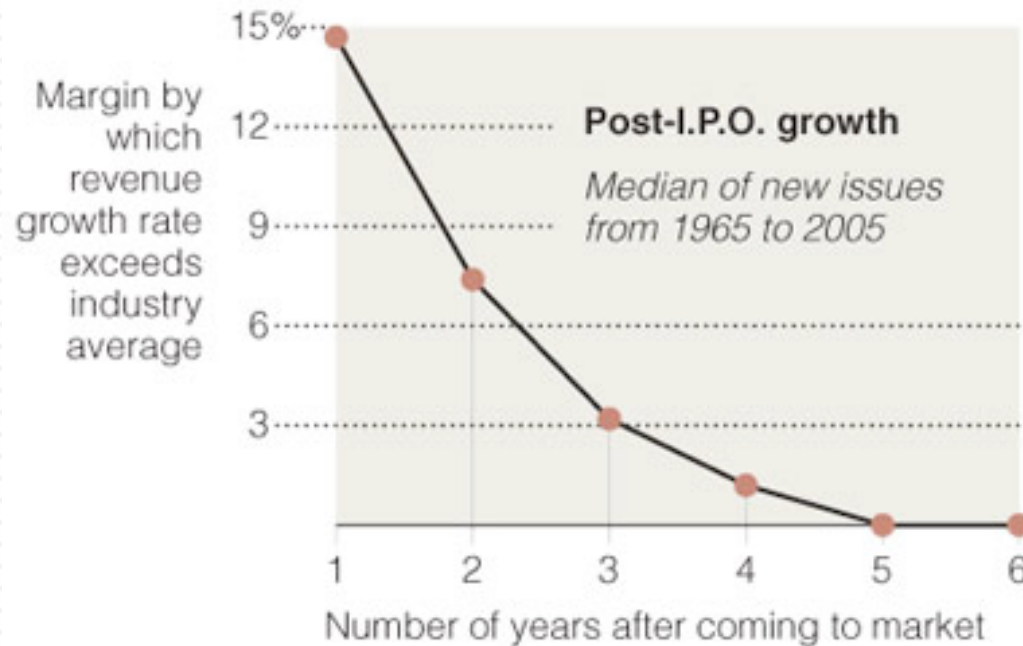

Source: Andrew Metrick

The New York Times

Lesson 5: Don't forget to pay for growth...

Year	Revenues	Δ Revenue	Sales/Cap	Δ Investment	Invested Capital	EBIT (1-t)	Imputed ROC
Tr 12 mths	\$1,117				\$ 487	-\$410	
1	\$2,793	\$1,676	3.00	\$559	\$ 1,045	-\$373	-76.62%
2	\$5,585	\$2,793	3.00	\$931	\$ 1,976	-\$94	-8.96%
3	\$9,774	\$4,189	3.00	\$1,396	\$ 3,372	\$407	20.59%
4	\$14,661	\$4,887	3.00	\$1,629	\$ 5,001	\$871	25.82%
5	\$19,059	\$4,398	3.00	\$1,466	\$ 6,467	\$1,058	21.16%
6	\$23,862	\$4,803	3.00	\$1,601	\$ 8,068	\$1,438	22.23%
7	\$28,729	\$4,868	3.00	\$1,623	\$ 9,691	\$1,799	22.30%
8	\$33,211	\$4,482	3.00	\$1,494	\$ 11,185	\$2,119	21.87%
9	\$36,798	\$3,587	3.00	\$1,196	\$ 12,380	\$2,370	21.19%
10	\$39,006	\$2,208	3.00	\$736	\$ 13,116	\$2,524	20.39%
TY	\$41,346	\$2,340	NA		Assumed to be =		20.00%

Lesson 6: There are always scenarios where the market price can be justified...

		Target pre-tax Operating Margin				
		6%	8%	10%	12%	14%
Compounded annual Revenue Growth rate	30%	\$ (1.94)	\$ 2.95	\$ 7.84	\$ 12.71	\$ 17.57
	35%	\$ 1.41	\$ 8.37	\$ 15.33	\$ 22.27	\$ 29.21
	40%	\$ 6.10	\$ 15.93	\$ 25.74	\$ 35.54	\$ 45.34
	45%	\$ 12.59	\$ 26.34	\$ 40.05	\$ 53.77	\$ 67.48
	50%	\$ 21.47	\$ 40.50	\$ 59.52	\$ 78.53	\$ 97.54
	55%	\$ 33.47	\$ 59.60	\$ 85.72	\$ 111.84	\$ 137.95
	60%	\$ 49.53	\$ 85.10	\$ 120.66	\$ 156.22	\$ 191.77

Lesson 7: Don't forget to mop up...

- Watch out for “other” equity claims: If you buy equity in a young, growth company, watch out for other (often hidden) claims on the equity that don't take the form of common shares. In particular, watch for options granted to managers, employees, venture capitalists and others (you will be surprised...).
 - ▣ Value these options as options (not at exercise value)
 - ▣ Take into consideration expectations of future option grants when computing expected future earnings/cash flows.
- Not all shares are equal: If there are differences in cash flow claims (dividends or liquidation) or voting rights across shares, value these differences.
 - ▣ Voting rights matter even at well run companies

Lesson 8: You will be wrong 100% of the time... and it really is not (always) your fault...

- No matter how careful you are in getting your inputs and how well structured your model is, your estimate of value will change both as new information comes out about the company, the business and the economy.
- As information comes out, you will have to adjust and adapt your model to reflect the information. Rather than be defensive about the resulting changes in value, recognize that this is the essence of risk.
- A test: If your valuations are unbiased, you should find yourself increasing estimated values as often as you are decreasing values. In other words, there should be equal doses of good and bad news affecting valuations (at least over time).

And the market is often “more wrong”....

Amazon: Value and Price

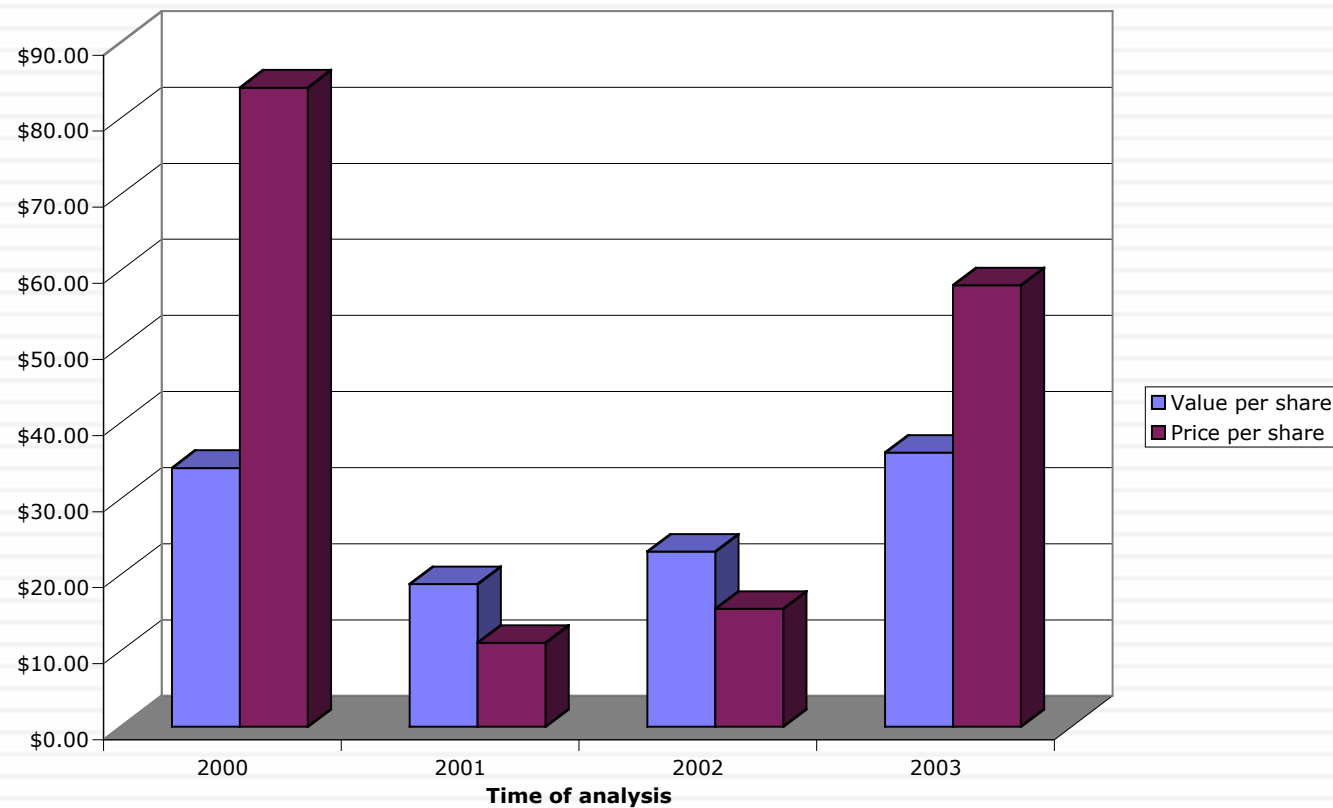

II. Dealing with decline and distress...

Historical data often reflects flat or declining revenues and falling margins. Investments often earn less than the cost of capital.

Growth can be negative, as firm sheds assets and shrinks. As less profitable assets are shed, the firm's remaining assets may improve in quality.

What is the value added by growth assets?

What are the cashflows from existing assets?

Underfunded pension obligations and litigation claims can lower value of equity. Liquidation preferences can affect value of equity

What is the value of equity in the firm?

How risky are the cash flows from both existing assets and growth assets?

Depending upon the risk of the assets being divested and the use of the proceeds from the divestiture (to pay dividends or retire debt), the risk in both the firm and its equity can change.

When will the firm become a mature firm, and what are the potential roadblocks?

There is a real chance, especially with high financial leverage, that the firm will not make it. If it is expected to survive as a going concern, it will be as a much smaller entity.

Current Revenue
\$ 4,390

Current Margin:
4.76%

EBIT
\$ 209m

Reinvestment:
Capital expenditures include cost of new casinos and working capital

Extended reinvestment break, due to investment in past

Industry average

Expected Margin:
-> 17%

Stable Growth

Stable Revenue Growth: 3%	Stable Operating Margin: 17%	Stable ROC=10% Reinvest 30% of EBIT(1-t)
---------------------------	------------------------------	---

Terminal Value = $758 \cdot (.0743 \cdot .03)$
= \$ 17,129

Value of Op Assets \$ 9,793
+ Cash & Non-op \$ 3,040
= Value of Firm \$ 12,833
- Value of Debt \$ 7,565
= Value of Equity \$ 5,268

Value per share \$ 8.12

Revenues	\$4,434	\$4,523	\$5,427	\$6,513	\$7,815	\$8,206	\$8,616	\$9,047	\$9,499	\$9,974
Oper margin	5.81%	6.86%	7.90%	8.95%	10%	11.40%	12.80%	14.20%	15.60%	17%
EBIT	\$258	\$310	\$429	\$583	\$782	\$935	\$1,103	\$1,285	\$1,482	\$1,696
Tax rate	26.0%	26.0%	26.0%	26.0%	26.0%	28.4%	30.8%	33.2%	35.6%	38.00%
EBIT * (1 - t)	\$191	\$229	\$317	\$431	\$578	\$670	\$763	\$858	\$954	\$1,051
- Reinvestment	-\$19	-\$11	\$0	\$22	\$58	\$67	\$153	\$215	\$286	\$350
FCFF	\$210	\$241	\$317	\$410	\$520	\$603	\$611	\$644	\$668	\$701
Beta	3.14	3.14	3.14	3.14	3.14	2.75	2.36	1.97	1.59	1.20
Cost of equity	21.82%	21.82%	21.82%	21.82%	21.82%	19.50%	17.17%	14.85%	12.52%	10.20%
Cost of debt	9%	9%	9%	9%	9%	8.70%	8.40%	8.10%	7.80%	7.50%
Debt/ratio	73.50%	73.50%	73.50%	73.50%	73.50%	68.80%	64.10%	59.40%	54.70%	50.00%
Cost of capital	9.88%	9.88%	9.88%	9.88%	9.88%	9.79%	9.50%	9.01%	8.32%	7.43%

Term. Year
\$10,273
17%
\$ 1,746
38%
\$1,083
\$ 325
\$758

Forever

Cost of Equity
21.82%

Cost of Debt
3%+6%= 9%
9% (1-.38)=5.58%

Weights
Debt= 73.5% ->50%

Riskfree Rate:
T. Bond rate = 3%

+ **Beta**
3.14-> 1.20

X **Risk Premium**
6%

Aswath Damodaran

Casino
1.15

Current
D/E: 277%

Base Equity
Premium

Country Risk
Premium

Las Vegas Sands
February 2009
Trading @ \$4.25

Adjusting the value of LVS for distress..

- In February 2009, LVS was rated B+ by S&P. Historically, 28.25% of B+ rated bonds default within 10 years. LVS has a 6.375% bond, maturing in February 2015 (7 years), trading at \$529. If we discount the expected cash flows on the bond at the riskfree rate, we can back out the probability of distress from the bond price:

$$529 = \sum_{t=1}^{t=7} \frac{63.75(1 - \Pi_{\text{Distress}})^t}{(1.03)^t} + \frac{1000(1 - \Pi_{\text{Distress}})^7}{(1.03)^7}$$

- Solving for the probability of bankruptcy, we get:
- π_{Distress} = Annual probability of default = 13.54%
 - ▣ Cumulative probability of surviving 10 years = $(1 - .1354)^{10} = 23.34\%$
 - ▣ Cumulative probability of distress over 10 years = $1 - .2334 = .7666$ or 76.66%
- If LVS is becomes distressed:
 - ▣ Expected distress sale proceeds = \$2,769 million < Face value of debt
 - ▣ Expected equity value/share = \$0.00
- Expected value per share = $\$8.12 (1 - .7666) + \$0.00 (.7666) = \$1.92$

III. Valuing cyclical and commodity companies

Company growth often comes from movements in the economic cycle, for cyclical firms, or commodity prices, for commodity companies.

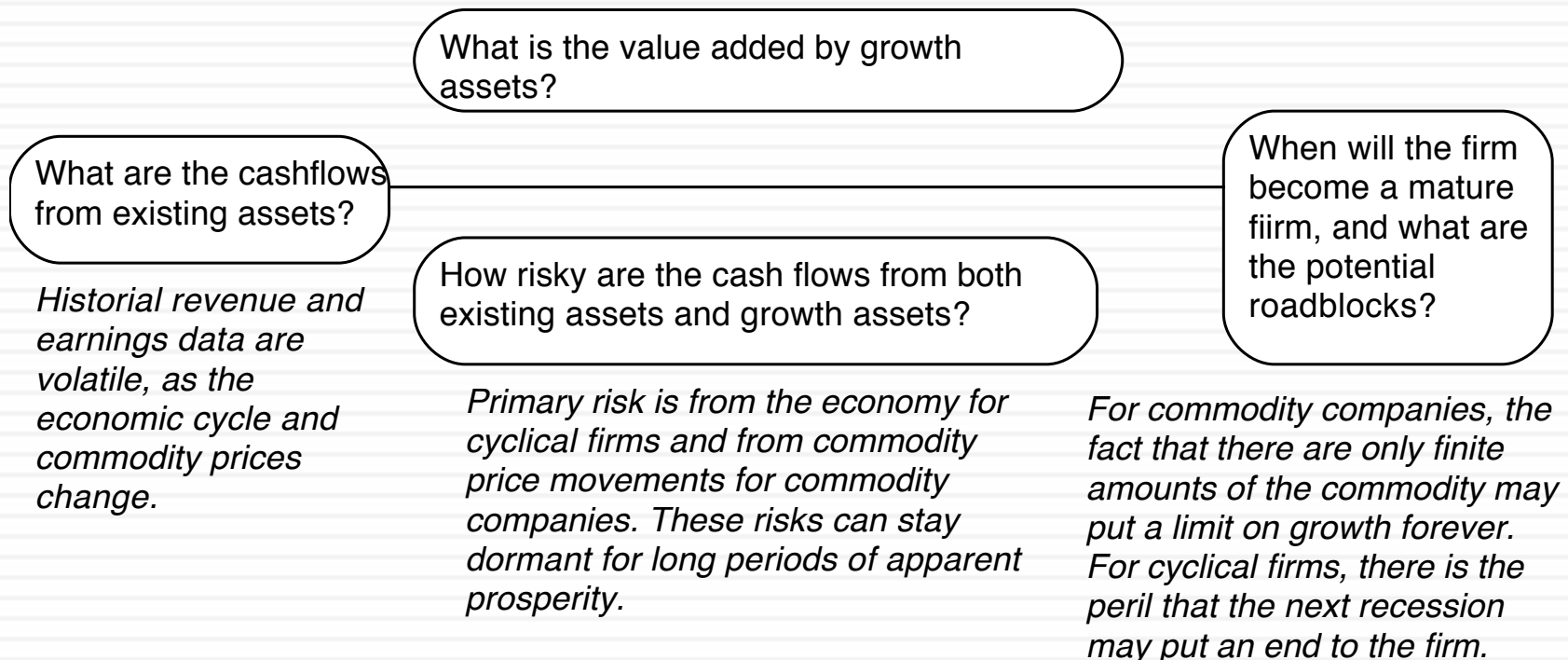

Valuing a Cyclical Company - Toyota in Early 2009

Year	Revenues	Operating Inco	EBITDA	Operating Marg
FY1 1992	¥10,163,380	¥218,511	¥218,511	2.15%
FY1 1993	¥10,210,750	¥181,897	¥181,897	1.78%
FY1 1994	¥9,362,732	¥136,226	¥136,226	1.45%
FY1 1995	¥8,120,975	¥255,719	¥255,719	3.15%
FY1 1996	¥10,718,740	¥348,069	¥348,069	3.25%
FY1 1997	¥12,243,830	¥665,110	¥665,110	5.43%
FY1 1998	¥11,678,400	¥779,800	¥1,382,950	6.68%
FY1 1999	¥12,749,010	¥774,947	¥1,415,997	6.08%
FY1 2000	¥12,879,560	¥775,982	¥1,430,982	6.02%
FY1 2001	¥13,424,420	¥870,131	¥1,542,631	6.48%
FY1 2002	¥15,106,300	¥1,123,475	¥1,822,975	7.44%
FY1 2003	¥16,054,290	¥1,363,680	¥2,101,780	8.49%
FY1 2004	¥17,294,760	¥1,666,894	¥2,454,994	9.64%
FY1 2005	¥18,551,530	¥1,672,187	¥2,447,987	9.01%
FY1 2006	¥21,036,910	¥1,878,342	¥2,769,742	8.93%
FY1 2007	¥23,948,090	¥2,238,683	¥3,185,683	9.35%
FY1 2008	¥26,289,240	¥2,270,375	¥3,312,775	8.64%
FY 2009 (Estin	¥22,661,325	¥267,904	¥1,310,304	1.18%
		¥1,306,867		7.33%

Normalized Earnings ①

As a cyclical company, Toyota's earnings have been volatile and 2009 earnings reflect the troubled global economy. We will assume that when economic growth returns, the operating margin for Toyota will revert back to the historical average.

Normalized Operating Income = Revenues in 2009 * Average Operating Margin (98--09)
 = 22661 * .0733 = 1660.7 billion yen

In early 2009, Toyota Motors had the highest market share in the sector. However, the global economic recession in 2008-09 had pulled earnings down.

Normalized Return on capital and Reinvestment ②

Once earnings bounce back to normal, we assume that Toyota will be able to earn a return on capital equal to its cost of capital (5.09%). This is a sector, where earning excess returns has proved to be difficult even for the best of firms.

To sustain a 1.5% growth rate, the reinvestment rate has to be:
 Reinvestment rate = 1.5%/5.09%
 = 29.46%

Operating Assets	19,640
+ Cash	2,288
+ Non-operating assets	6,845
- Debt	11,862
- Minority Interests	583
Value of Equity	
/ No of shares	/3,448
Value per share	¥4735

$$\text{Value of operating assets} = \frac{1660.7 (1.015) (1 - .407) (1 - .2946)}{(.0509 - .015)} = 19,640 \text{ billion}$$

Normalized Cost of capital ③

The cost of capital is computed using the average beta of automobile companies (1.10), and Toyota's cost of debt (3.25%) and debt ratio (52.9% debt ratio). We use the Japanese marginal tax rate of 40.7% for computing both the after-tax cost of debt and the after-tax operating income

$$\text{Cost of capital} = (1.10 * 0.0509 * (1 - 0.407)) + 3.25\% * (1 - 0.407) * (0.529) = 5.09\%$$

Stable Growth ④

Once earnings are normalized, we assume that Toyota, as the largest market-share company, will be able to maintain only stable growth (1.5% in Yen terms)

Valuing a commodity company - Exxon in Early 2009

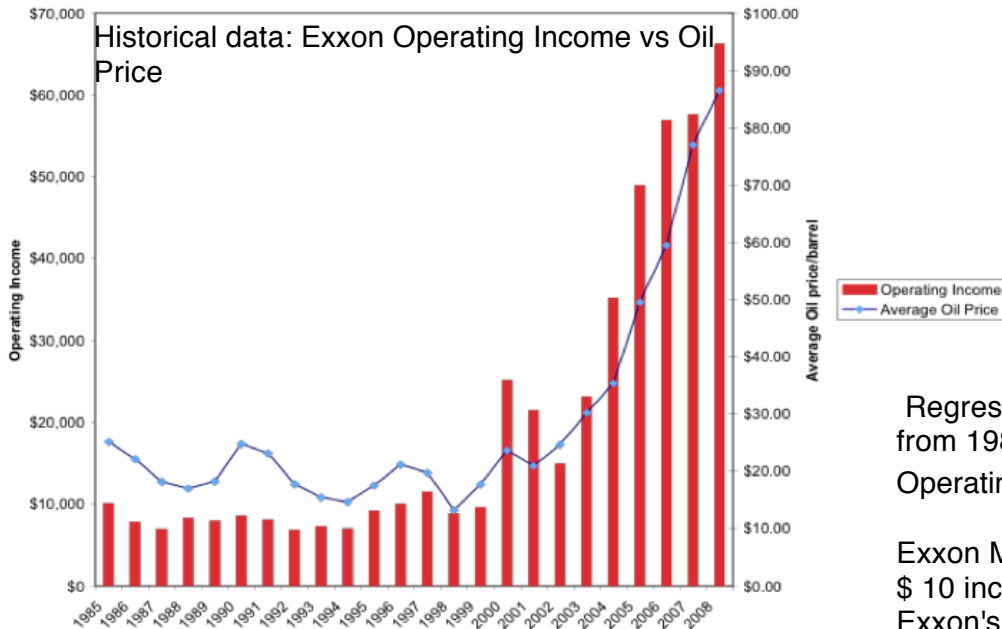

Regressing Exxon's operating income against the oil price per barrel from 1985-2008:

$$\text{Operating Income} = -6,395 + 911.32 (\text{Average Oil Price}) \quad R^2 = 90.2\%$$

(2.95) (14.59)

Exxon Mobil's operating income increases about \$9.11 billion for every \$ 10 increase in the price per barrel of oil and 90% of the variation in Exxon's earnings over time comes from movements in oil prices.

Estimate normalized income based on current oil price ①

At the time of the valuation, the oil price was \$ 45 a barrel. Exxon's operating income based on this price is
 Normalized Operating Income = $-6,395 + 911.32 (\$45) = \$34,614$

Estimate return on capital and reinvestment rate based on normalized income ②

This operating income translates into a return on capital of approximately 21% and a reinvestment rate of 9.52%, based upon a 2% growth rate.
 Reinvestment Rate = $g / \text{ROC} = 2 / 21\% = 9.52\%$

$$\text{Value of operating assets} = \frac{34,614(1 - .38)(1 - .0952)}{(.0818 - .02)} = \$320,472 \text{ million}$$

Exxon's cost of capital ④

Exxon has been a predominantly equity funded company, and is expected to remain so, with a debt ratio of only 2.85%. Its cost of equity is 8.35% (based on a beta of 0.90) and its pre-tax cost of debt is 3.75% (given AAA rating). The marginal tax rate is 38%.
 Cost of capital = $8.35\% (0.9715) + 3.75\% (1 - .38) (.0285) = 8.18\%$

Expected growth in operating income ③

Since Exxon Mobile is the largest oil company in the world, we will assume an expected growth of only 2% in perpetuity.

Exxon Mobil Valuation: Simulation

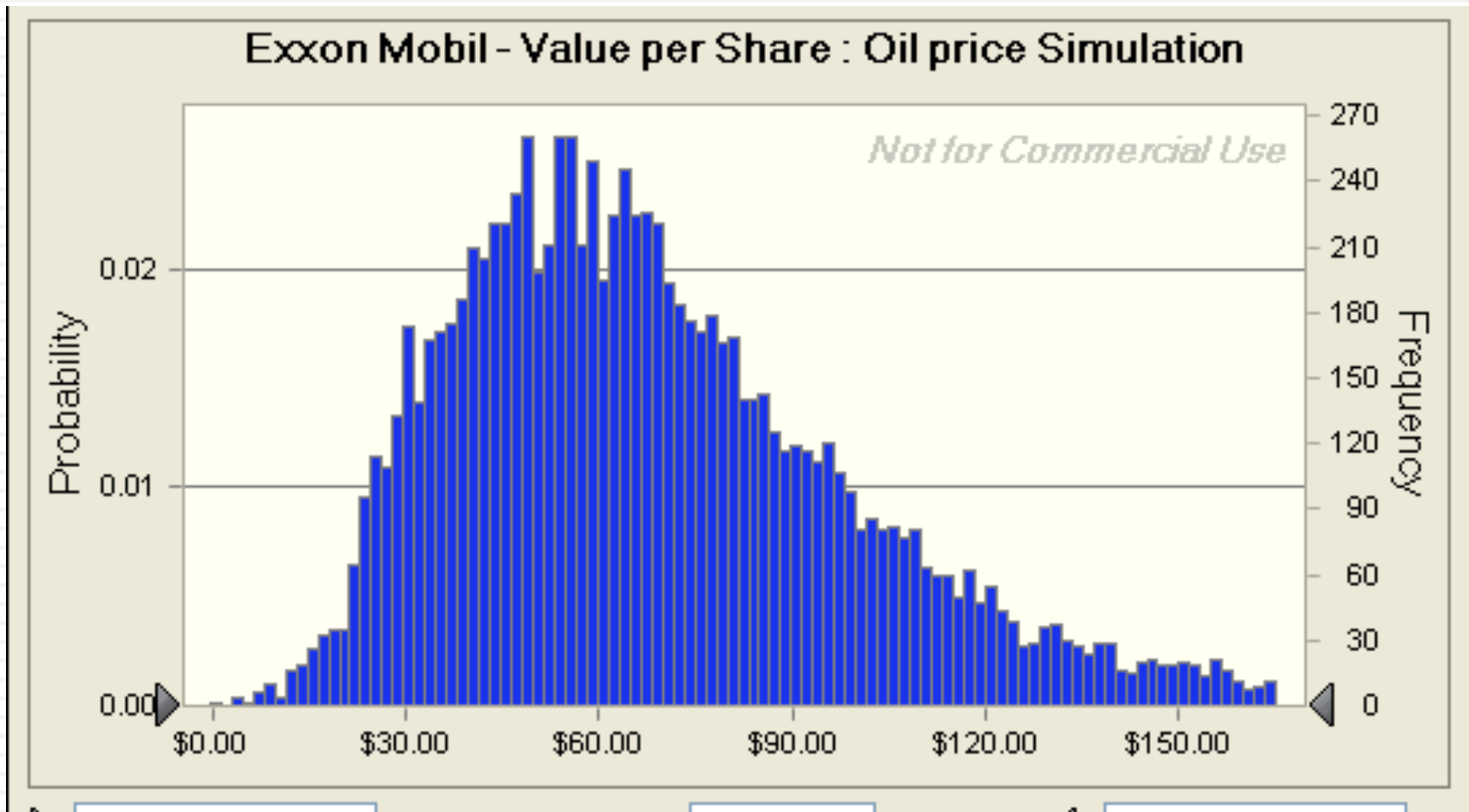

IV. Valuing Companies across the ownership cycle

Reported income and balance sheet are heavily affected by tax considerations rather than information disclosure requirements. The line between the personal and business expenses is a fine one.

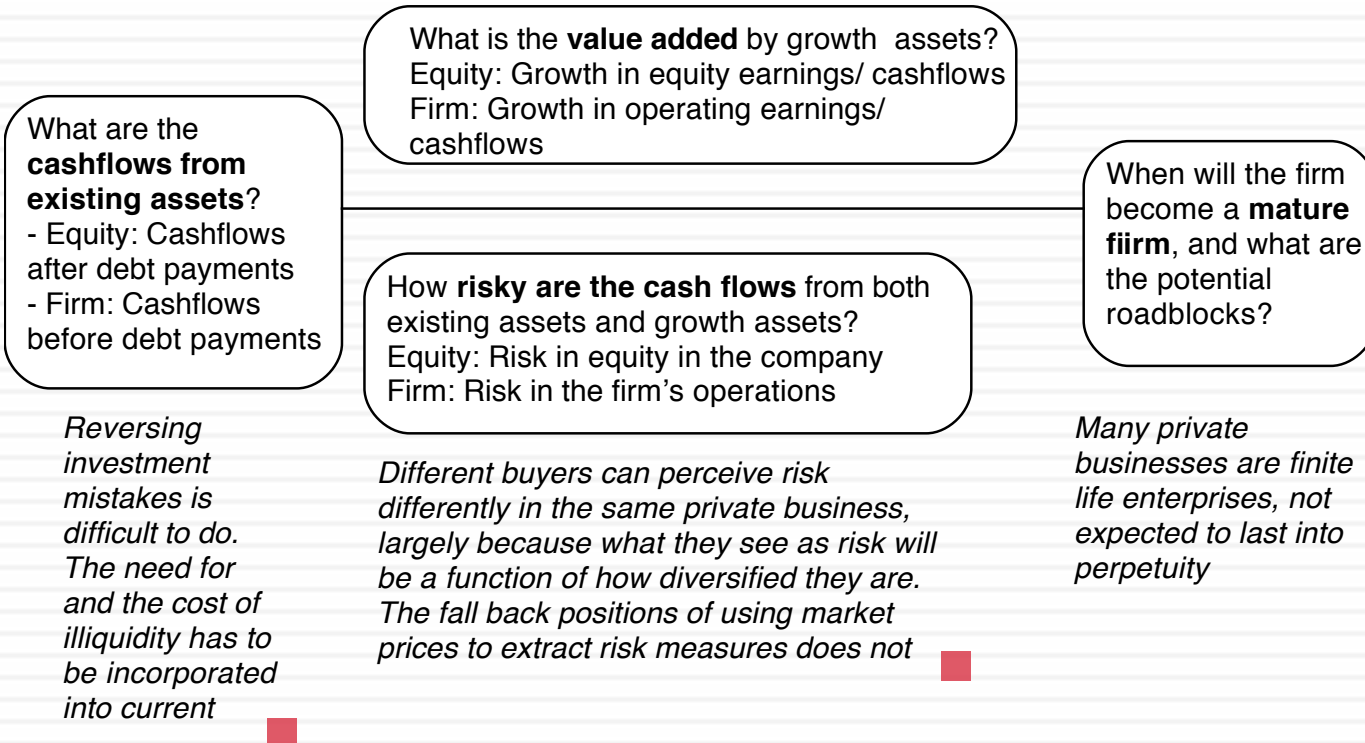

Kristin's Kandy: Valuation in March 2006

Current Cashflow to Firm
 EBIT(1-t) : 300
 - Nt CpX 100
 - Chg WC 40
 = FCFF 160
 Reinvestment Rate = 46.67%

Reinvestment Rate
 46.67%

Expected Growth in EBIT (1-t)
 $.4667 * .1364 = .0636$
6.36%

Return on Capital
 13.64%

Stable Growth
 $g = 4\%$; $\text{Beta} = 3.00$;
 $\text{ROC} = 12.54\%$
 Reinvestment Rate = 31.90%

Terminal Value $_5 = 289 / (.1254 - .04) = 3,403$

Firm Value: 2,571
 + Cash 125
 - Debt: 900
 = Equity 1,796
 - Illiq Discount 12.5%
 Adj Value 1,571

Year	1	2	3	4	5	Term Yr
EBIT (1-t)	\$319	\$339	\$361	\$384	\$408	425
- Reinvestment	\$149	\$158	\$168	\$179	\$191	136
=FCFF	\$170	\$181	\$193	\$205	\$218	289

Discount at Cost of Capital (WACC) = 16.26% (.70) + 3.30% (.30) = 12.37%

Cost of Equity
 16.26%

Cost of Debt
 $(4.5\% + 1.00)(1 - .40) = 3.30\%$
 Synthetic rating = A-

Weights
 E = 70% D = 30%

Riskfree Rate:
 Riskfree rate = 4.50%
 (10-year T.Bond rate)

Total Beta
 2.94

X

Risk Premium
 4.00%

+
 1/3 of risk is market risk

Adjusted for ownrer non-diversification

Market Beta: 0.98

Mature risk premium 4%

Country Risk Premium 0%

Aswath Damodaran

Unlevered Beta for Sectors: 0.78

Firm's D/E Ratio: 30/70

Total Risk versus Market Risk

- Adjust the beta to reflect total risk rather than market risk. This adjustment is a relatively simple one, since the R squared of the regression measures the proportion of the risk that is market risk.
 - Total Beta = Market Beta / Correlation of the sector with the market
- To estimate the beta for Kristin Kandy, we begin with the bottom-up unlevered beta of food processing companies:
 - Unlevered beta for publicly traded food processing companies = 0.78
 - Average correlation of food processing companies with market = 0.333
 - Unlevered total beta for Kristin Kandy = $0.78/0.333 = 2.34$
 - Debt to equity ratio for Kristin Kandy = $0.3/0.7$ (assumed industry average)
 - Total Beta = $2.34 (1 - (1-.40)(30/70)) = 2.94$
 - Total Cost of Equity = $4.50\% + 2.94 (4\%) = 16.26\%$

Aswath Damodaran



RELATIVE VALUATION

Aswath Damodaran

Relative valuation is pervasive...

- Most asset valuations are relative.
- Most equity valuations on Wall Street are relative valuations.
 - Almost 85% of equity research reports are based upon a multiple and comparables.
 - More than 50% of all acquisition valuations are based upon multiples
 - Rules of thumb based on multiples are not only common but are often the basis for final valuation judgments.
- While there are more discounted cashflow valuations in consulting and corporate finance, they are often relative valuations masquerading as discounted cash flow valuations.
 - The objective in many discounted cashflow valuations is to back into a number that has been obtained by using a multiple.
 - The terminal value in a significant number of discounted cashflow valuations is estimated using a multiple.

The Reasons for the allure...

- “If you think I’ m crazy, you should see the guy who lives across the hall”

Jerry Seinfeld talking about Kramer in a Seinfeld episode

- “ A little inaccuracy sometimes saves tons of explanation”

H.H. Munro

- “ If you are going to screw up, make sure that you have lots of company”

Ex-portfolio manager

The Four Steps to Deconstructing Multiples

- Define the multiple
 - In use, the same multiple can be defined in different ways by different users. When comparing and using multiples, estimated by someone else, it is critical that we understand how the multiples have been estimated
- Describe the multiple
 - Too many people who use a multiple have no idea what its cross sectional distribution is. If you do not know what the cross sectional distribution of a multiple is, it is difficult to look at a number and pass judgment on whether it is too high or low.
- Analyze the multiple
 - It is critical that we understand the fundamentals that drive each multiple, and the nature of the relationship between the multiple and each variable.
- Apply the multiple
 - Defining the comparable universe and controlling for differences is far more difficult in practice than it is in theory.

Definitional Tests

- Is the multiple consistently defined?
 - Proposition 1: Both the value (the numerator) and the standardizing variable (the denominator) should be to the same claimholders in the firm. In other words, the value of equity should be divided by equity earnings or equity book value, and firm value should be divided by firm earnings or book value.
- Is the multiple uniformly estimated?
 - The variables used in defining the multiple should be estimated uniformly across assets in the “comparable firm” list.
 - If earnings-based multiples are used, the accounting rules to measure earnings should be applied consistently across assets. The same rule applies with book-value based multiples.

Example 1: Price Earnings Ratio: Definition

PE = Market Price per Share / Earnings per Share

- There are a number of variants on the basic PE ratio in use. They are based upon how the price and the earnings are defined.

Price: is usually the current price

is sometimes the average price for the year

EPS: EPS in most recent financial year

EPS in trailing 12 months (Trailing PE)

Forecasted EPS next year (Forward PE)

Forecasted EPS in future year

Example 2: Enterprise Value /EBITDA Multiple

- The enterprise value to EBITDA multiple is obtained by netting cash out against debt to arrive at enterprise value and dividing by EBITDA.

$$\frac{\text{Enterprise Value}}{\text{EBITDA}} = \frac{\text{Market Value of Equity} + \text{Market Value of Debt} - \text{Cash}}{\text{Earnings before Interest, Taxes and Depreciation}}$$

- Why do we net out cash from firm value?
- What happens if a firm has cross holdings which are categorized as:
 - ▣ Minority interests?
 - ▣ Majority active interests?

Descriptive Tests

- What is the average and standard deviation for this multiple, across the universe (market)?
- What is the median for this multiple?
 - The median for this multiple is often a more reliable comparison point.
- How large are the outliers to the distribution, and how do we deal with the outliers?
 - Throwing out the outliers may seem like an obvious solution, but if the outliers all lie on one side of the distribution (they usually are large positive numbers), this can lead to a biased estimate.
- Are there cases where the multiple cannot be estimated? Will ignoring these cases lead to a biased estimate of the multiple?
- How has this multiple changed over time?

1. Multiples have skewed distributions...

PE Ratios for US stocks: January 2015

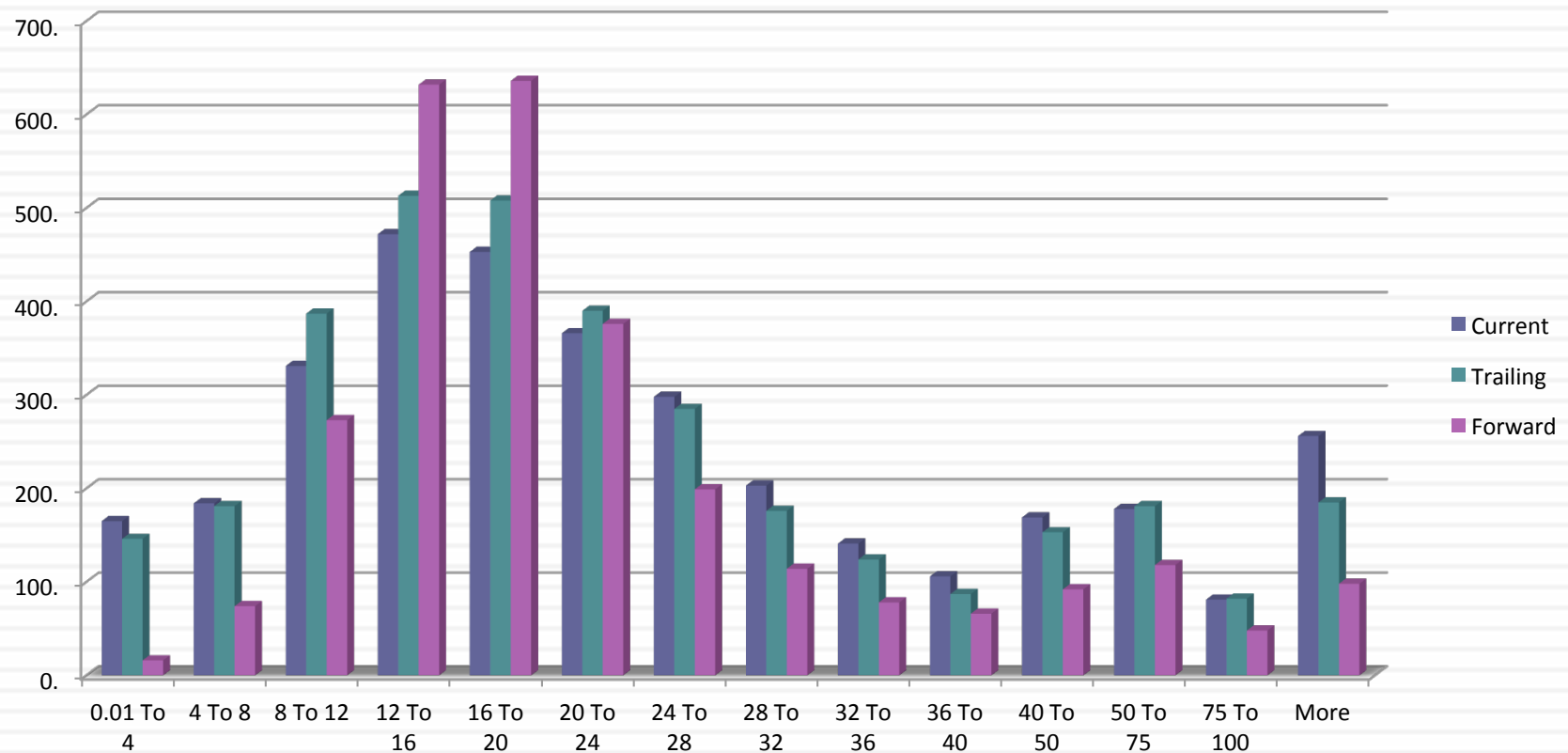

2. Making statistics “dicey”

	<i>Current PE</i>	<i>Trailing PE</i>	<i>Forward PE</i>
Number of firms	7887	7887	7887
Number with PE	3403	3398	2820
Average	72.13	60.49	35.25
Median	20.88	19.74	18.32
Minimum	0.25	0.4	1.15
Maximum	23,100.	23,100.	5,230.91
Standard deviation	509.6	510.41	139.75
Standard error	8.74	8.76	2.63
Skewness	31.	32.77	25.04
25th percentile	13.578	13.2	14.32
75th percentile	33.86	31.16	25.66

3. Markets have a lot in common : Comparing Global PEs

PE Ratio Distribution: Global Comparison in January 2015

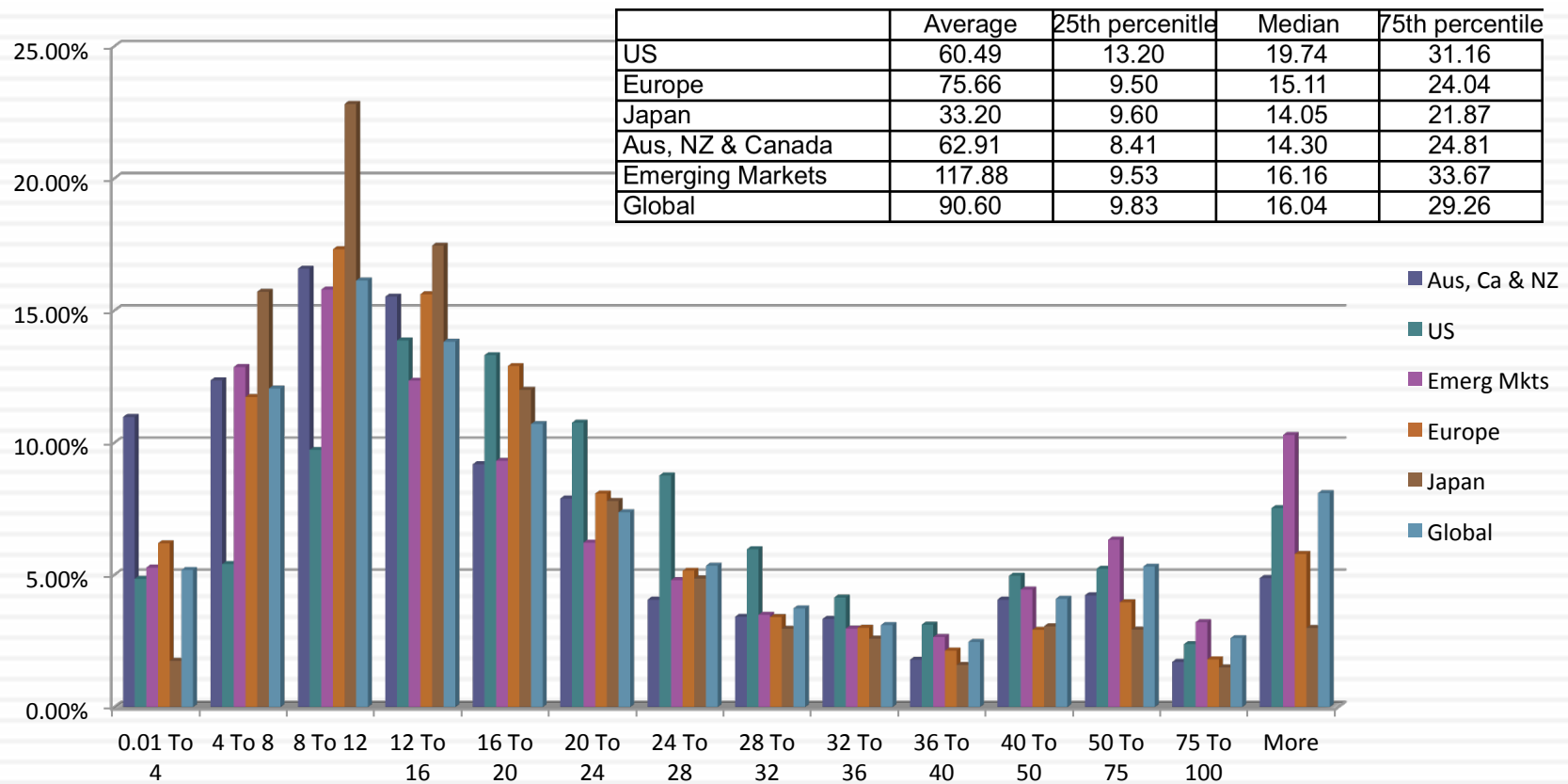

4. Simplistic rules almost always break down...6 times EBITDA may not be cheap...

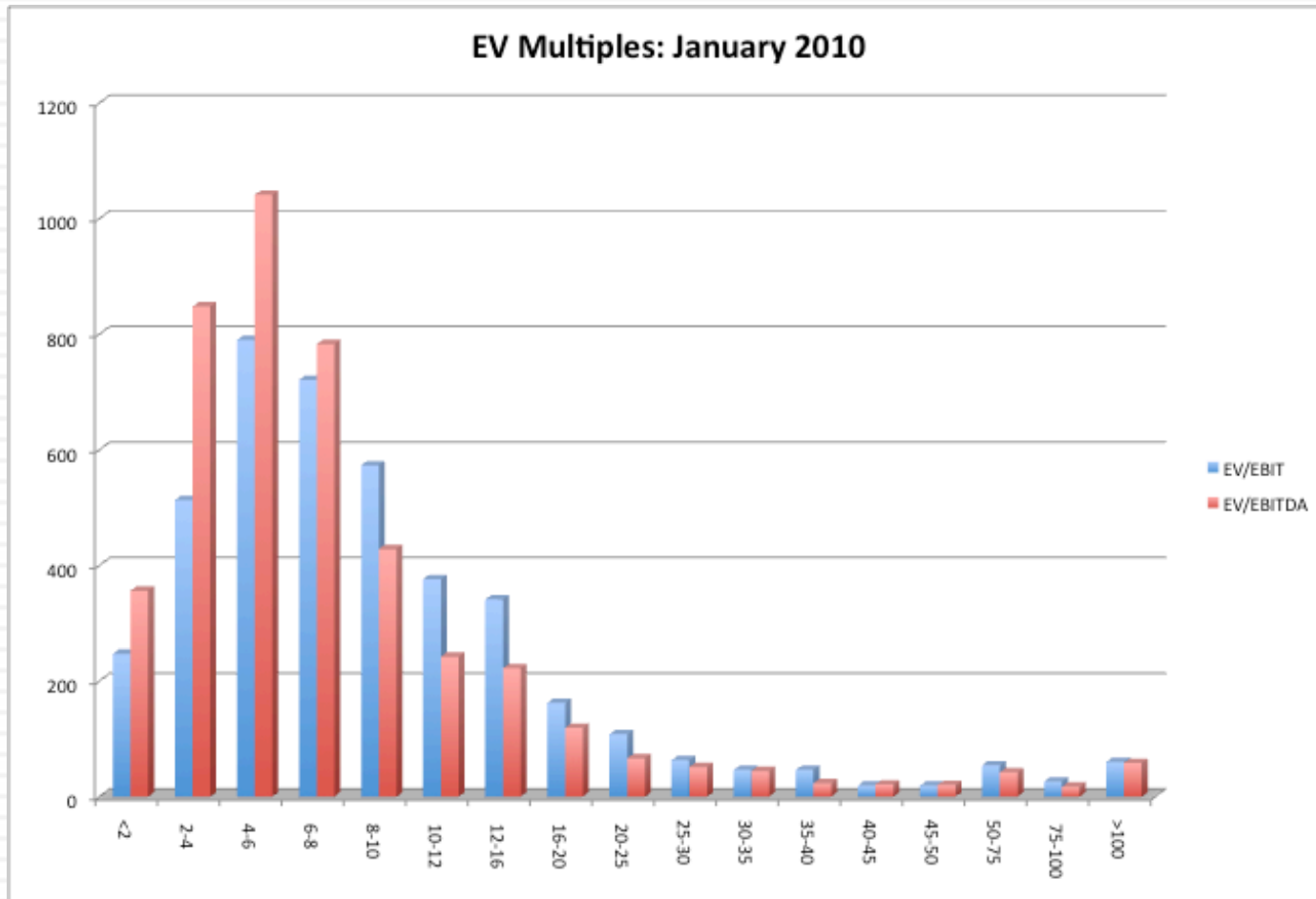

But it may be in 2015, unless you are in Japan, Australia or Canada

EV/EBITDA: A Global Comparison - January 2015

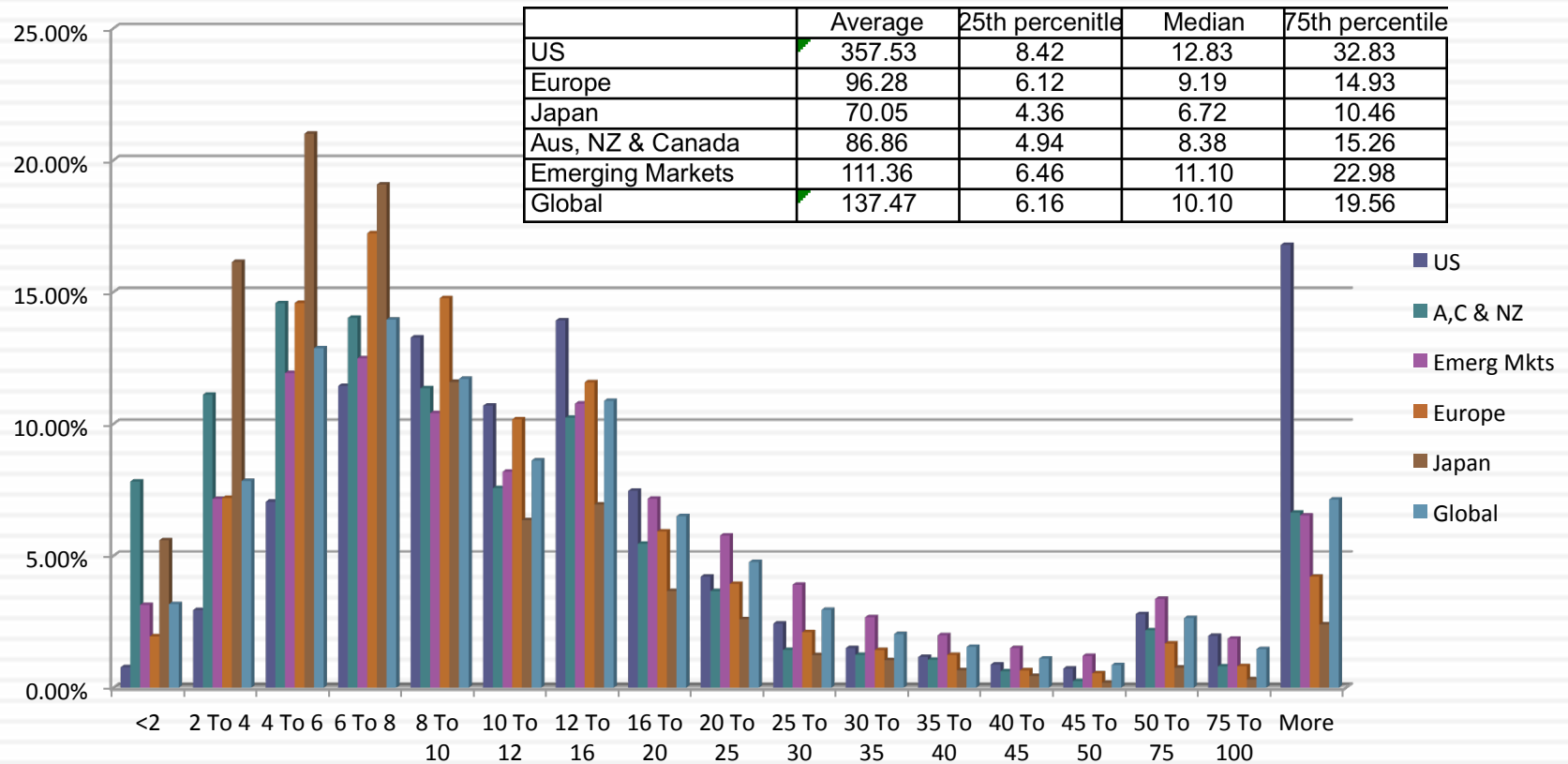

Analytical Tests

- What are the fundamentals that determine and drive these multiples?
 - Proposition 2: Embedded in every multiple are all of the variables that drive every discounted cash flow valuation - growth, risk and cash flow patterns.
 - In fact, using a simple discounted cash flow model and basic algebra should yield the fundamentals that drive a multiple
- How do changes in these fundamentals change the multiple?
 - The relationship between a fundamental (like growth) and a multiple (such as PE) is seldom linear. For example, if firm A has twice the growth rate of firm B, it will generally not trade at twice its PE ratio
 - Proposition 3: It is impossible to properly compare firms on a multiple, if we do not know the nature of the relationship between fundamentals and the multiple.

PE Ratio: Understanding the Fundamentals

- To understand the fundamentals, start with a basic equity discounted cash flow model.
- With the dividend discount model,

$$P_0 = \frac{DPS_1}{r - g_n}$$

- Dividing both sides by the current earnings per share,

$$\frac{P_0}{EPS_0} = PE = \frac{\text{Payout Ratio} * (1 + g_n)}{r - g_n}$$

- If this had been a FCFE Model,

$$P_0 = \frac{FCFE_1}{r - g_n}$$

$$\frac{P_0}{EPS_0} = PE = \frac{(\text{FCFE/Earnings}) * (1 + g_n)}{r - g_n}$$

The Determinants of Multiples...

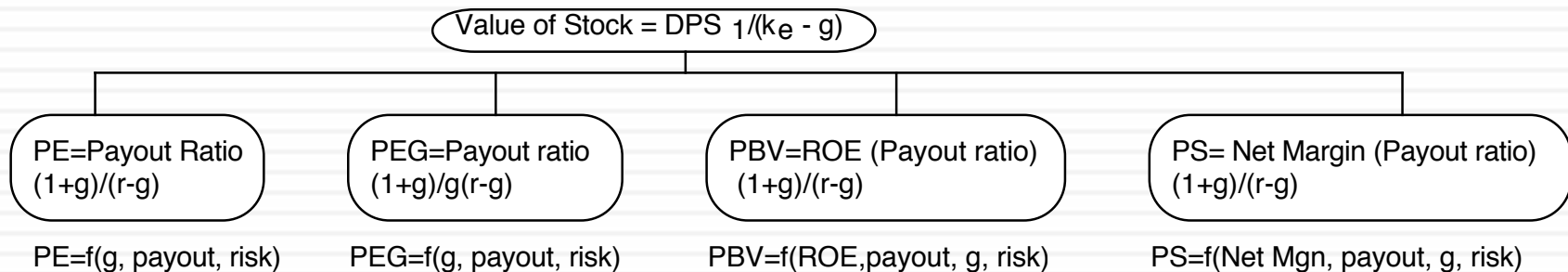

Equity Multiples

Firm Multiples

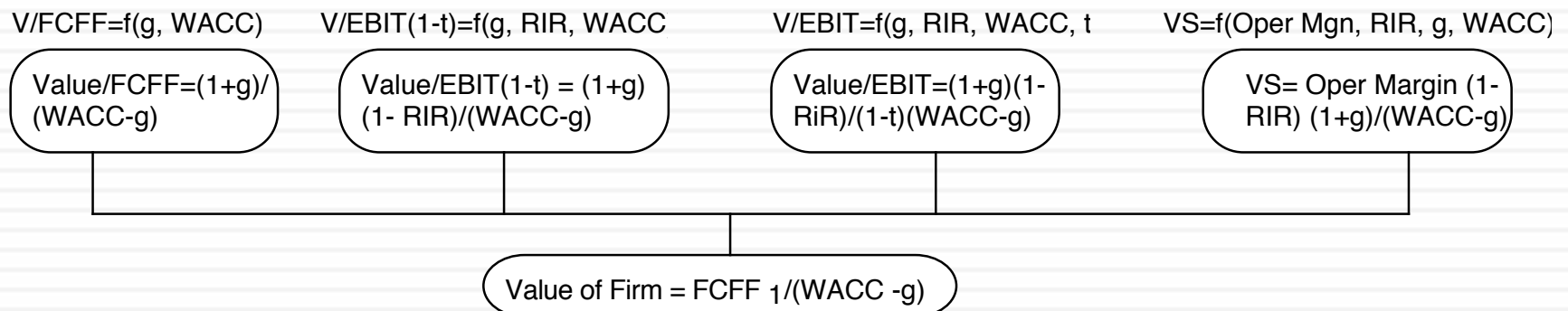

Application Tests

- Given the firm that we are valuing, what is a “comparable” firm?
 - While traditional analysis is built on the premise that firms in the same sector are comparable firms, valuation theory would suggest that a comparable firm is one which is similar to the one being analyzed in terms of fundamentals.
 - Proposition 4: There is no reason why a firm cannot be compared with another firm in a very different business, if the two firms have the same risk, growth and cash flow characteristics.
- Given the comparable firms, how do we adjust for differences across firms on the fundamentals?
 - Proposition 5: It is impossible to find an exactly identical firm to the one you are valuing.

An Example: Comparing PE Ratios across a Sector: PE

<i>Company Name</i>	<i>PE</i>	<i>Growth</i>
<i>PT Indosat ADR</i>	<i>7.8</i>	<i>0.06</i>
<i>Telebras ADR</i>	<i>8.9</i>	<i>0.075</i>
<i>Telecom Corporation of New Zealand ADR</i>	<i>11.2</i>	<i>0.11</i>
<i>Telecom Argentina Stet - France Telecom SA ADR B</i>	<i>12.5</i>	<i>0.08</i>
<i>Hellenic Telecommunication Organization SA ADR</i>	<i>12.8</i>	<i>0.12</i>
<i>Telecomunicaciones de Chile ADR</i>	<i>16.6</i>	<i>0.08</i>
<i>Swisscom AG ADR</i>	<i>18.3</i>	<i>0.11</i>
<i>Asia Satellite Telecom Holdings ADR</i>	<i>19.6</i>	<i>0.16</i>
<i>Portugal Telecom SA ADR</i>	<i>20.8</i>	<i>0.13</i>
<i>Telefonos de Mexico ADR L</i>	<i>21.1</i>	<i>0.14</i>
<i>Matav RT ADR</i>	<i>21.5</i>	<i>0.22</i>
<i>Telstra ADR</i>	<i>21.7</i>	<i>0.12</i>
<i>Gilat Communications</i>	<i>22.7</i>	<i>0.31</i>
<i>Deutsche Telekom AG ADR</i>	<i>24.6</i>	<i>0.11</i>
<i>British Telecommunications PLC ADR</i>	<i>25.7</i>	<i>0.07</i>
<i>Tele Danmark AS ADR</i>	<i>27</i>	<i>0.09</i>
<i>Telekomunikasi Indonesia ADR</i>	<i>28.4</i>	<i>0.32</i>
<i>Cable & Wireless PLC ADR</i>	<i>29.8</i>	<i>0.14</i>
<i>APT Satellite Holdings ADR</i>	<i>31</i>	<i>0.33</i>
<i>Telefonica SA ADR</i>	<i>32.5</i>	<i>0.18</i>
<i>Royal KPN NV ADR</i>	<i>35.7</i>	<i>0.13</i>
<i>Telecom Italia SPA ADR</i>	<i>42.2</i>	<i>0.14</i>
<i>Nippon Telegraph & Telephone ADR</i>	<i>44.3</i>	<i>0.2</i>
<i>France Telecom SA ADR</i>	<i>45.2</i>	<i>0.19</i>
<i>Korea Telecom ADR</i>	<i>71.3</i>	<i>0.44</i>

PE, Growth and Risk

- Dependent variable is: PE
- R squared = 66.2% R squared (adjusted) = 63.1%

Variable	Coefficient	SE	t-ratio	Probability
Constant	13.1151	3.471	3.78	0.0010
Growth rate	121.223	19.27	6.29	≤ 0.0001
Emerging Market	-13.853	13.606	-3.84	0.0009
Emerging Market is a dummy:			1 if emerging market 0 if not	

Applying to Telebras,

$$\text{Predicted PE} = 13.15 + 121.22 (.075) - 13.85 = 8.39$$

After controlling for lower growth & higher risk, the stock is overvalued.

PE Ratio: Standard Regression for US stocks - January 2015

101

Model Summary^a

Model	R	R Square	Adjusted R Square	Std. Error of the Estimate
1	.597 ^b	.356	.355	1002.538

a. Broad Group = United States

b. Predictors: (Constant), Expected growth rate in EPS- Next 5 years, Beta, Payout ratio

The regression is run with growth and payout entered as decimals, i.e., 25% is entered as 0.25)

Coefficients^{a,b,c}

Model		Unstandardized Coefficients		Standardized Coefficients	t	Sig.
		B	Std. Error	Beta		
1	(Constant)	6.479	1.204		5.380	.000
	Beta	-3.248	.840	-.108	-3.866	.000
	Payout ratio	16.772	1.290	.365	12.998	.000
	Expected growth rate in EPS- Next 5 years	98.579	4.428	.588	22.260	.000

a. Broad Group = United States

b. Dependent Variable: Trailing PE

c. Weighted Least Squares Regression - Weighted by Market Cap (in US \$)

PE ratio regressions across markets

102

Region	Regression – January 2015	R ²
US	PE = 6.48 + 98.58 g_{EPS} + 16.77 Payout - 3.25 Beta	35.5%
Europe	PE = 19.32 + 43.89 g_{EPS} + 5.14 Payout - 4.45 Beta	17.4%
Japan	PE = 7.85 + 32.48 g_{EPS} + 31.32 Payout - 1.165 Beta	25.2%
Emerging Markets	PE = 10.90 + 57.47 g_{EPS} + 7.62 Payout - 2.36 Beta	27.0%
Global	PE = 12.49 + 56.89 g_{EPS} + 10.40 Payout - 3.10 Beta	23.3%

g_{EPS} = Expected Growth: Expected growth in EPS or Net Income: Next 5 years

Beta: Regression or Bottom up Beta

Payout ratio: Dividends/ Net income from most recent year. Set to zero, if net income < 0

Conventional usage...

Sector	Multiple Used	Rationale
Cyclical Manufacturing	PE, Relative PE	Often with normalized earnings
Growth firms	PEG ratio	Big differences in growth rates
Young growth firms w/ losses	Revenue Multiples	What choice do you have?
Infrastructure	EV/EBITDA	Early losses, big DA
REIT	P/CFE (where CFE = Net income + Depreciation)	Big depreciation charges on real estate
Financial Services	Price/ Book equity	Marked to market?
Retailing	Revenue multiples	Margins equalize sooner or later

A closing thought...

