



PRICE AND VALUE: DISCERNING THE DIFFERENCE

May 2014

Aswath Damodaran

Poll Question 1

2

- If your job is attaching a number to an asset/
business, what do you view as your primary mission?
 - a. To value a business
 - b. To price a business
 - c. To do both
 - d. Don't know what the difference between the two is

Test 1: Are you pricing or valuing?

3

 **5369 La Jolla Mesa Dr**
La Jolla, CA 92037
Status: Active

\$995,000
Price

3
Beds

2.5
Baths

1,440 Sq. Ft.
\$691 / Sq. Ft.

Built: 1955 **Lot Size:** 3,000 Sq. Ft. **On Redfin:** 12 days

[Favorite](#) [X-Out](#) [Share...](#) [Tour Home](#)

[Overview](#) [Property Details](#) [Tour Insights](#) [Property History](#) [Public Records](#) [Activity](#) [Schools](#) [Neighborhood & Offer Insights](#) [Similar Homes](#)



1 of 25 [Play Video](#)

Lisa Padilla
REDFIN Real Estate Agent

★★★★★
47 client reviews

\$8,726 commission refund

[Go Tour This Home](#)

[Ask Lisa a Question](#) or [Start an Offer](#)

1 of 4 Redfin Agents in this area

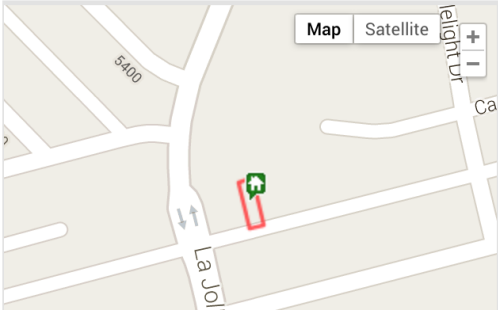

Test 2: Are you pricing or valuing?

4

The image shows a Ticketmaster interface for a stadium event. On the left is a seating chart with colored dots indicating deal quality. On the right is a search results table for 4 tickets.

Search Parameters:
 # Tickets: 4
 E-tickets only:
 Price per ticket (including seller's fees and shipping): \$717 - \$7349

Deal Score	Section	Market	Price per ticket
Great Deals (?)			
82	117	7 tix PRINESPORT	\$2,413
82	117	6 tix PRINESPORT	\$2,413
82	117	8 tix PRINESPORT	\$2,413
82	139	4 tix TN Direct	\$3,486
81	224 A	14 tix PRINESPORT	\$1,760
81	126	12 tix TN Direct	\$1,849

Legend: Awful Deals (red to green dots) Best Deals (green dot)

Sponsored: State Farm It pays to Double-Check!

Test 3: Are you pricing or valuing?

5

Europe
Switzerland

Biotechnology
Biotechnology

Reuters BION.S Bloomberg BION SW Exchange SWX Ticker BION

Price at 12 Aug 2013 (CHF)	124.00
Price Target (CHF)	164.50
52-week range (CHF)	128.40 - 84.90

Strong sector and stock-picking continue

Impressive performance

Over the past two years, BB Biotech shares have roughly tripled, which could tempt investors to take profits. However, this performance has been well backed by a deserved revival of the biotech industry, encouraging fundamental news, M&A, and increased money flow into health care stocks. In addition, BBB returned to index outperformance by modifying its stock-picking approach. Hence, despite excellent performance, the shares still trade at a 23% discount to the net asset value of the portfolio. Hence, the shares are an attractive value vehicle to capture growth opportunities in an attractive sector.

Biotech industry remains attractive

With the re-rating of the pharma sector, investors have also showed increased interest in biotech stocks. Established biotech stocks have delivered encouraging financial results and approvals, while there has also been substantial industry consolidation, which is not surprising in times of "cheap" money and high liquidity. BB Biotech remains an attractive vehicle to capture the future potential of the biotech sector. In addition, investors benefit from a 23% discount to NAV and attractive cash distribution policy of 5% yield p.a. Hence, we reiterate our Buy on BB Biotech shares.

Key changes

Target Price 106.50 to 164.50 ↑ 54.5%

Source: Deutsche Bank

Price/price relative

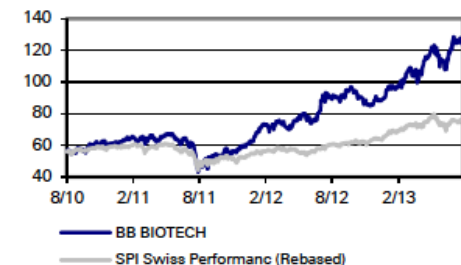

Performance (%)	1m	3m	12m
Absolute	-1.4	5.4	37.4

Test 4: Are you pricing or valuing?

6

A Venture Capital “Valuation”

Today

Young software company
Revenues = \$2 m
Earnings (Loss) = -\$1 m

Exit Year (Year 3)

Estimated revenues = \$50 m
Estimated earnings = \$10 million
Exit Earnings Multiple = 20
Estimated Exit Value = \$10 * 20 = \$200 m

Value today
= $200/1.5^3$
= \$59.26 m

Discount back at target rate of return on 50%

Test 5: Are you pricing or valuing?

7

	1	2	3	4	5
EBITDA	\$100.00	\$120.00	\$144.00	\$172.80	\$207.36
- Depreciation	\$20.00	\$24.00	\$28.80	\$34.56	\$41.47
EBIT	\$80.00	\$96.00	\$115.20	\$138.24	\$165.89
- Taxes	\$24.00	\$28.80	\$34.56	\$41.47	\$49.77
EBIT (1-t)	\$56.00	\$67.20	\$80.64	\$96.77	\$116.12
+ Depreciation	\$20.00	\$24.00	\$28.80	\$34.56	\$41.47
- Cap Ex	\$50.00	\$60.00	\$72.00	\$86.40	\$103.68
- Chg in WC	\$10.00	\$12.00	\$14.40	\$17.28	\$20.74
FCFF	\$16.00	\$19.20	\$23.04	\$27.65	\$33.18
Terminal Value					\$1,658.88
Cost of capital	8.25%	8.25%	8.25%	8.25%	8.25%
Present Value	\$14.78	\$16.38	\$18.16	\$20.14	\$1,138.35
Value of operating assets today	\$1,207.81				
+ Cash	\$125.00				
- Debt	\$200.00				
Value of equity	\$1,132.81				

Test 6: Are you pricing or valuing?

8

- In FAS 157, here is what it says: “The exchange price is the price in an orderly transaction between market participants to sell the asset or transfer ... The transaction to sell the asset or transfer the liability is a hypothetical transaction at the measurement date, considered from the perspective of a market participant that holds the asset or owes the liability. Therefore, the definition focuses on the price that would be received to sell the asset or paid to transfer the liability (an exit price), not the price that would be paid to acquire the asset or received to assume the liability (an entry price).”
- If you are an accountant, given the task of putting FAS 157 into practice, are you being asked to
 - a. Value the assets/liabilities on a balance sheet
 - b. Price the assets/liabilities on a balance sheet

Price versus Value: The Set up

9

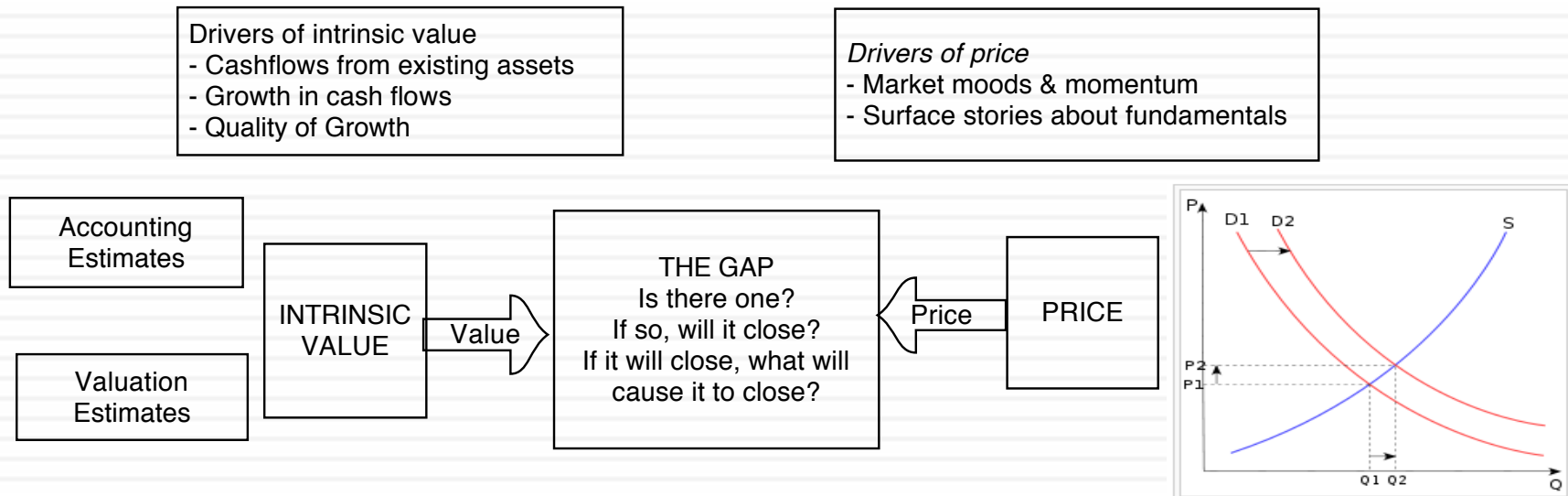

Poll Question 2: Price versus Value: Let's test your priors on the gap

10

- Let's start with the proposition that the value of an asset is based on its fundamentals, and that intrinsic value is the tool that you use to estimate that value and that the price of the asset is based on demand/supply and that multiples/comparables are what you use to estimate price. Assume that you do both well. Would you expect the price = value?
 - a. Yes, at least, on average
 - b. No

Poll Question 3: Price versus Value: Your priors on the direction

11

- If you believe that there is a gap between price and value, which of the following do you think is the most likely direction?
 - a. Price will be greater than value, because intrinsic valuation is inherently conservative
 - b. Value will be greater than price, because markets don't capture the intangibles
 - c. Either can happen, depending on..

The traditional accounting balance sheet...

Valued based upon motive for investment – some marked to market, some recorded at cost and some at quasi-cost

Assets are recorded at original cost, adjusted for depreciation.

The Balance Sheet

Assets		Liabilities	
Long Lived Real Assets	Fixed Assets	Current Liabilities	Short-term liabilities of the firm
Short-lived Assets	Current Assets	Debt	Debt obligations of firm
Investments in securities & assets of other firms	Financial Investments	Other Liabilities	Other long-term obligations
Assets which are not physical, like patents & trademarks	Intangible Assets	Equity	Equity investment in firm

True intangible assets like brand name, patents and customer did not show up. The only intangible asset of any magnitude (goodwill) is a plug variable that is of consequence only if you do an acquisition.

Equity reflects original capital invested and historical retained earnings.

The intrinsic value balance sheet

Recorded at intrinsic value (based upon cash flows and risk), not at original cost



Value will depend upon magnitude of growth investments and excess returns on these investments

Intrinsic value of equity, reflecting intrinsic value of assets, net of true value of debt outstanding.

The “Market Price” balance sheet

A Market Value Balance Sheet

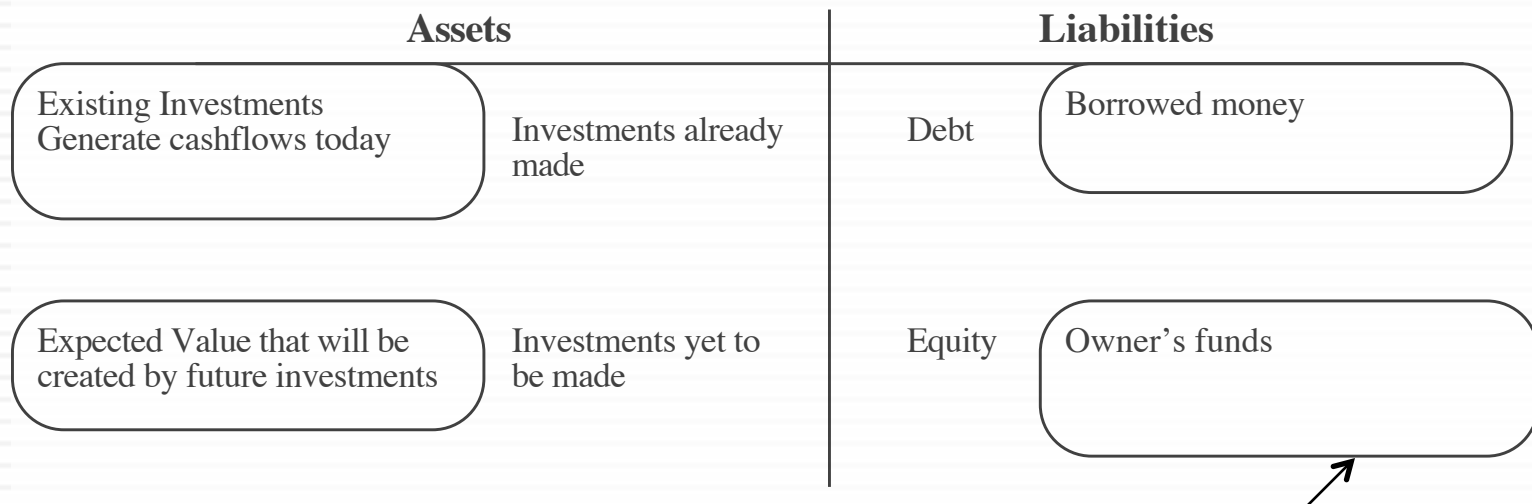

Should equate to market value of equity, if publicly traded.

Assets recorded at market value, i.e, what investors will be willing to pay for the assets today (rather than original cost or intrinsic value)

Twitter: The Contrast in November 2013

15

Accounting Balance Sheet

Cash	\$550	Debt (leases)	\$21
PP&E	\$ 62	Preferred stock	\$835
Intangible assets	\$6	Equity	\$202
Goodwill	\$ 47		

Intrinsic Value Balance Sheet (post-IPO)

Cash	\$ 1,616	Debt	\$ 214
Assets in place	\$ 73	Equity	\$11,106
Growth assets	\$ 9,631		

Market Price Balance Sheet (post-IPO)

Cash	\$ 1,816	Debt	\$ 214
Assets in place	\$ 73	Equity	\$28,119
Growth assets	\$ 26,444		



INTRINSIC VALUATION
CASH FLOWS, GROWTH & RISK

Intrinsic value is simple: We choose to make it complex

17

For cash flow generating assets, the intrinsic value will be a function of the magnitude of the expected cash flows on the asset over its lifetime and the uncertainty about receiving those cash flows.

1. *The IT Proposition:* If “it” does not affect the cash flows or alter risk (thus changing discount rates), “it” cannot affect value.
2. *The DUH Proposition:* For an asset to have value, the expected cash flows have to be positive some time over the life of the asset.
3. *The DON'T FREAK OUT Proposition:* Assets that generate cash flows early in their life will be worth more than assets that generate cash flows later; the latter may however have greater growth and higher cash flows to compensate.
4. *The VALUE IS NOT PRICE Proposition:* The value of an asset may be very different from its price.

The determinants of value

18

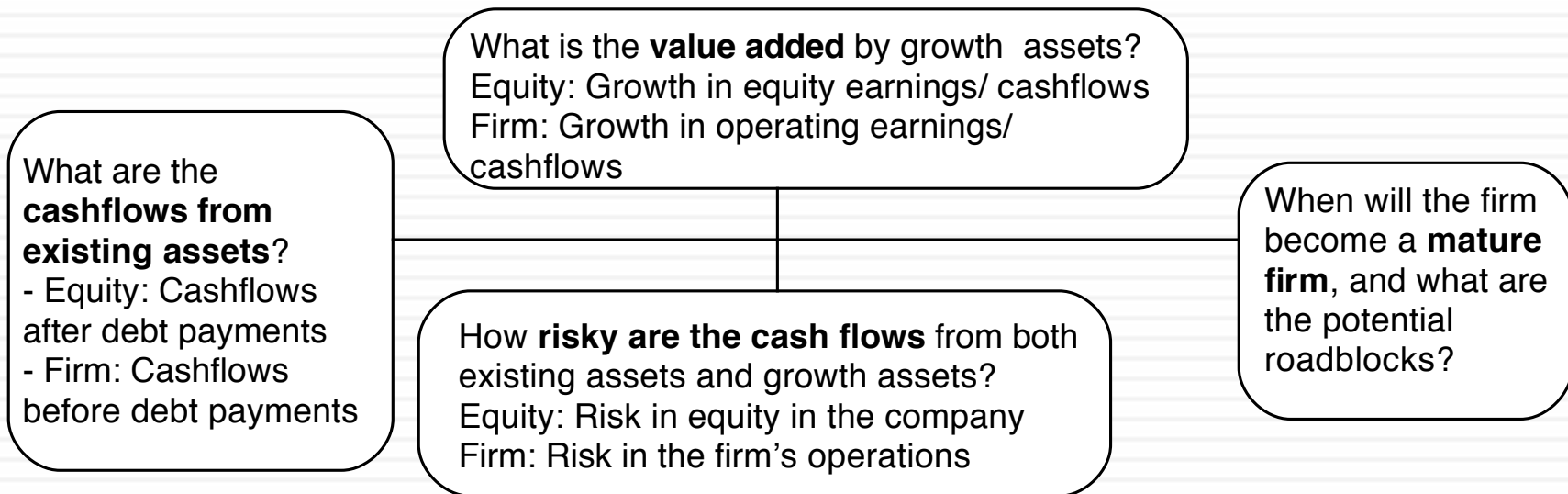

DCF as a tool for intrinsic valuation

19

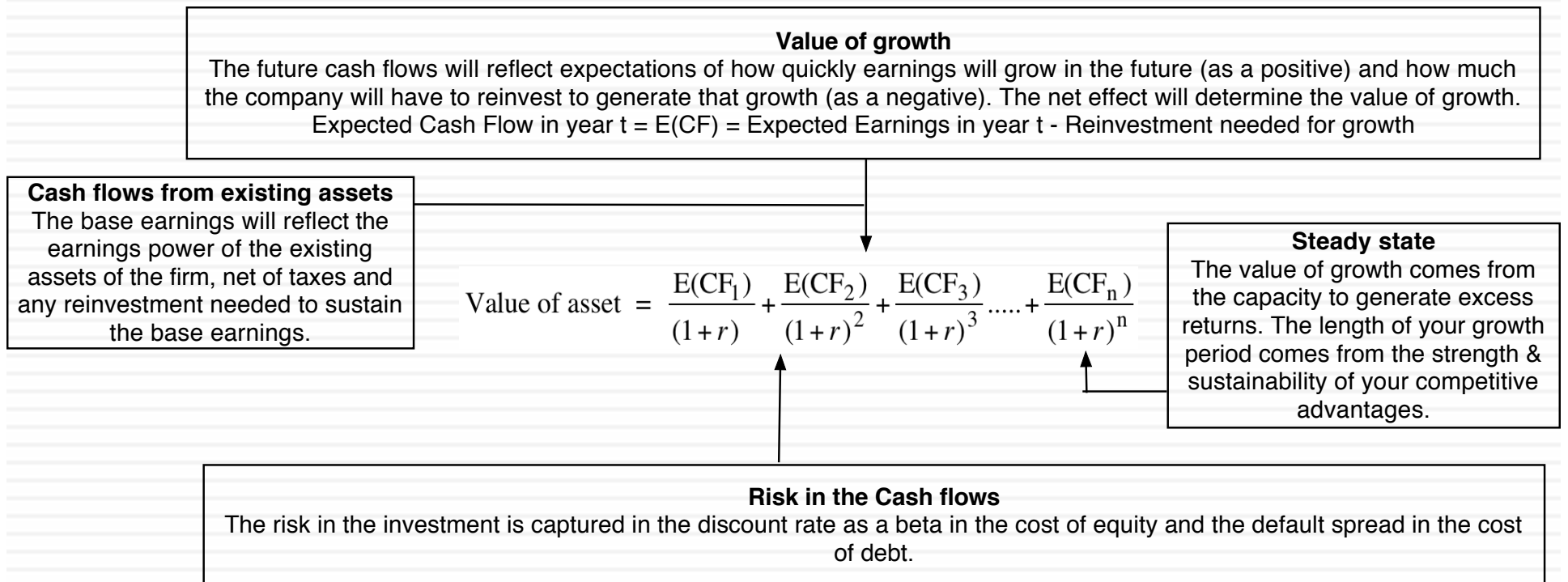

Poll Question 4: Input Importance

20

- If you do DCF valuations, what do you spend the bulk of your time doing?
 - a. Developing the story line for valuation (narrative)
 - b. Estimating cash flows
 - c. Estimating discount rates
 - d. Adjusting the DCF value for loose ends (illiquidity, control)
 - e. Presentation of the valuation

1. Cash Flows

21

To get to cash flow	Here is why
Operating Earnings	This is the earnings before interest & taxes you generate from your existing assets. Operating Earnings = Revenues * Operating Margin Measures the operating efficiency of your assets & can be grown either by growing revenues and/or improving margins.
(minus) Taxes	These are the taxes you would pay on your operating income and are a function of the tax code under which you operate & your fidelity to that code.
(minus) Reinvestment	Reinvestment is designed to generate future growth and can be in long term and short term assets. Higher growth usually requires more reinvestment, and the efficiency of growth is a function of how much growth you can get for your reinvestment.
Free Cash Flow to the Firm	This is a pre-debt cash flow that will be shared by lenders (as interest & principal payments) and by equity investors (as dividends & buybacks).

As

2. Discount rates

22

Expected Return on a Risky Investment = Cost of Equity

Risk free Rate

Rate of return on a long term, default free bond.

Will vary across currencies and across time.

+

Beta

Relative measure of risk added to a diversified portfolio.

Determined by the business or businesses that you operate in, with more exposure to macro economic risk translating into a higher beta.

=

X

Equity Risk Premium

Premium investors demand over and above the risk free rate for investing in equities as a class.

Function of the countries that you do business in and how much value you derive from each country.

3. Expected Growth

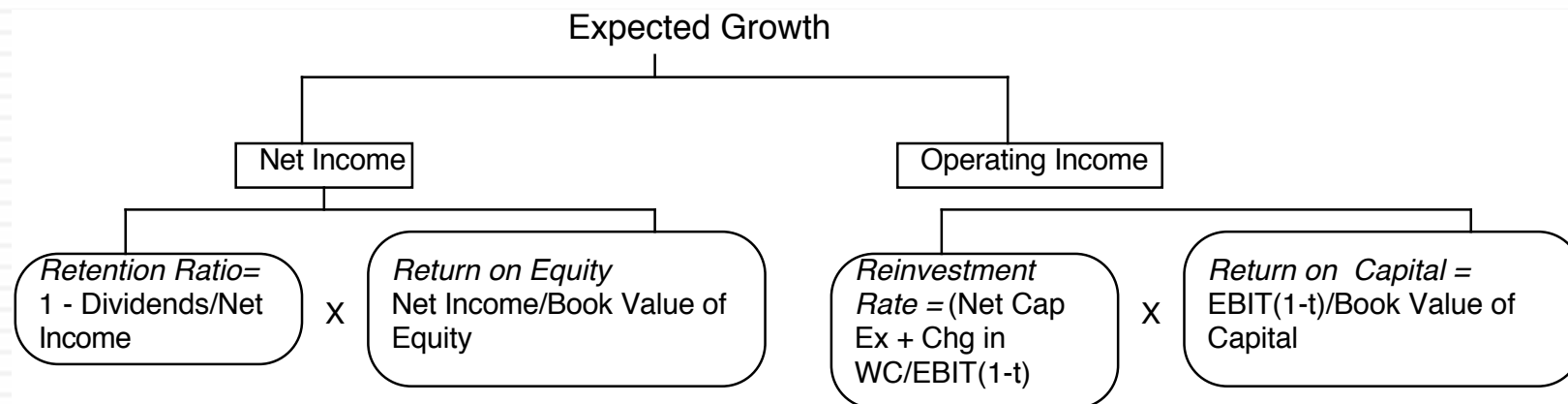

- Quality growth is rare and requires that a firm be able to reinvest a lot and reinvest well (earnings more than your cost of capital) at the same time.
- The larger you get, the more difficult it becomes to maintain quality growth.
- You can grow while destroying value at the same time.

And its value...

ROIC versus Cost of Capital: A Global Assessment for 2013

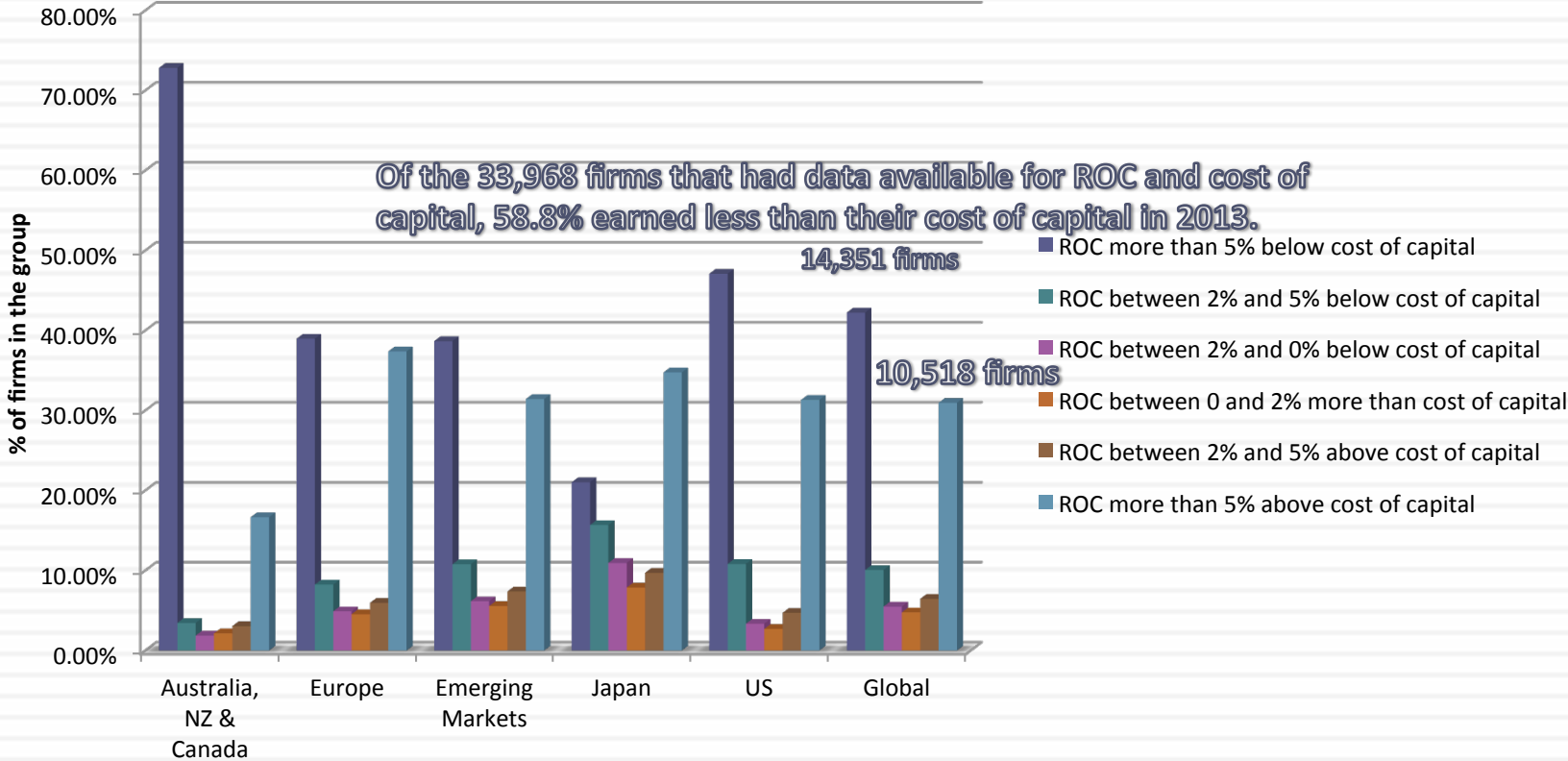

4. The Terminal Value

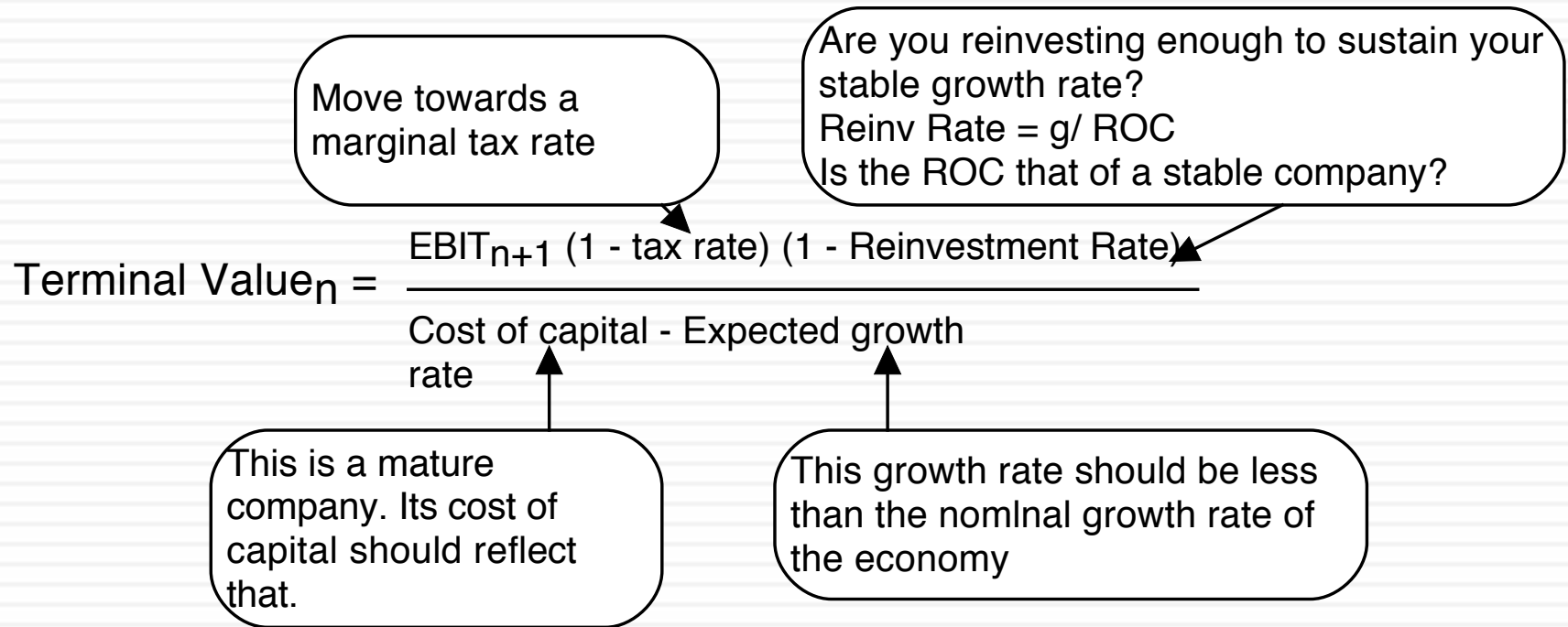

If your job is assessing value, here are your challenges...

26

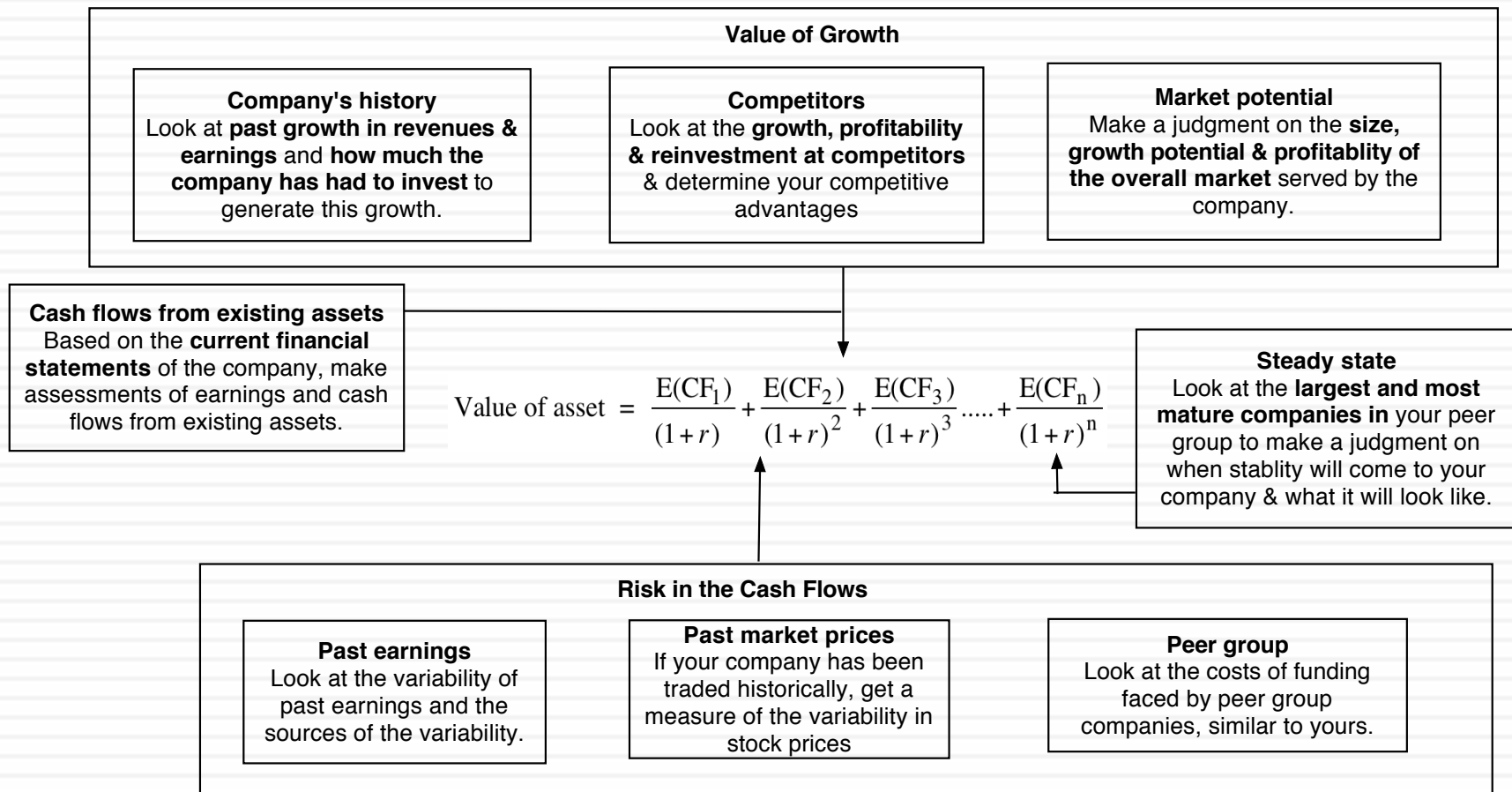

Disney - November 2013

Current Cashflow to Firm
 EBIT(1-t) = 10,032(1-.31) = 6,920
 - (Cap Ex - Deprecn) 3,629
 - Chg Working capital 103
 = FCFF 3,188
 Reinvestment Rate = 3,732/6920 = 53.93%
 Return on capital = 12.61%

Reinvestment Rate
53.93%

Return on Capital
12.61%

Expected Growth
 $.5393 * .1261 = .068$ or 6.8%

Stable Growth
 g = 2.5%; Beta = 1.00;
 Debt % = 20%; k(debt) = 3.75
 Cost of capital = 7.29%
 Tax rate = 36.1%; ROC = 10%;
 Reinvestment Rate = 2.5/10 = 25%

Terminal Value₁₀ = 9,086 / (.0729 - .025) = 189,738

First 5 years

Growth declines gradually to 2.75%

	1	2	3	4	5	6	7	8	9	10
EBIT * (1 - tax rate)	\$7,391	\$7,893	\$8,430	\$9,003	\$9,615	\$10,187	\$10,704	\$11,156	\$11,531	\$11,819
- Reinvestment	\$3,985	\$4,256	\$4,546	\$4,855	\$5,185	\$4,904	\$4,534	\$4,080	\$3,550	\$2,955
FCFF	\$3,405	\$3,637	\$3,884	\$4,148	\$4,430	\$5,283	\$6,170	\$7,076	\$7,981	\$8,864

Term Yr
12,114
3,029
9,086

Op. Assets 125,484
 + Cash: 3,931
 + Non op inv 2,849
 - Debt 15,961
 - Minority Int 2,721
 = Equity 113,582
 - Options 869
Value/Share \$ 62.26

Cost of Capital (WACC) = 8.52% (0.885) + 2.40% (0.115) = 7.81%

Cost of capital declines gradually to 7.29%

Cost of Equity
8.52%

Cost of Debt
 (2.75% + 1.00%)(1 - .361)
 = 2.40%
 Based on actual A rating

Weights
 E = 88.5% D = 11.5%

In November 2013,
 Disney was trading at
 \$67.71/share

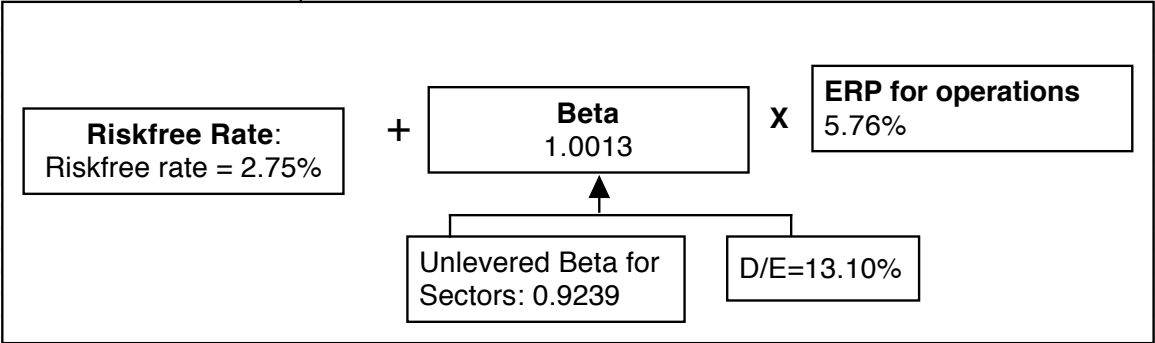

Poll Question 5: Dealing with uncertainty

28

- In which of the following companies is valuation easiest to do?
 - a. Mature companies in stable sectors
 - b. Young companies in stable sectors
 - c. Mature companies in evolving/changing sectors
 - d. Young companies in evolving/changing sectors
- In which of the companies is valuation most useful?

So, how about a young start-up company?

Figure 3: Estimation Issues - Young and Start-up Companies

Making judgments on revenues/ profits difficult because you cannot draw on history. If you have no product/service, it is difficult to gauge market potential or profitability. The company's entire value lies in future growth but you have little to base your estimate on.

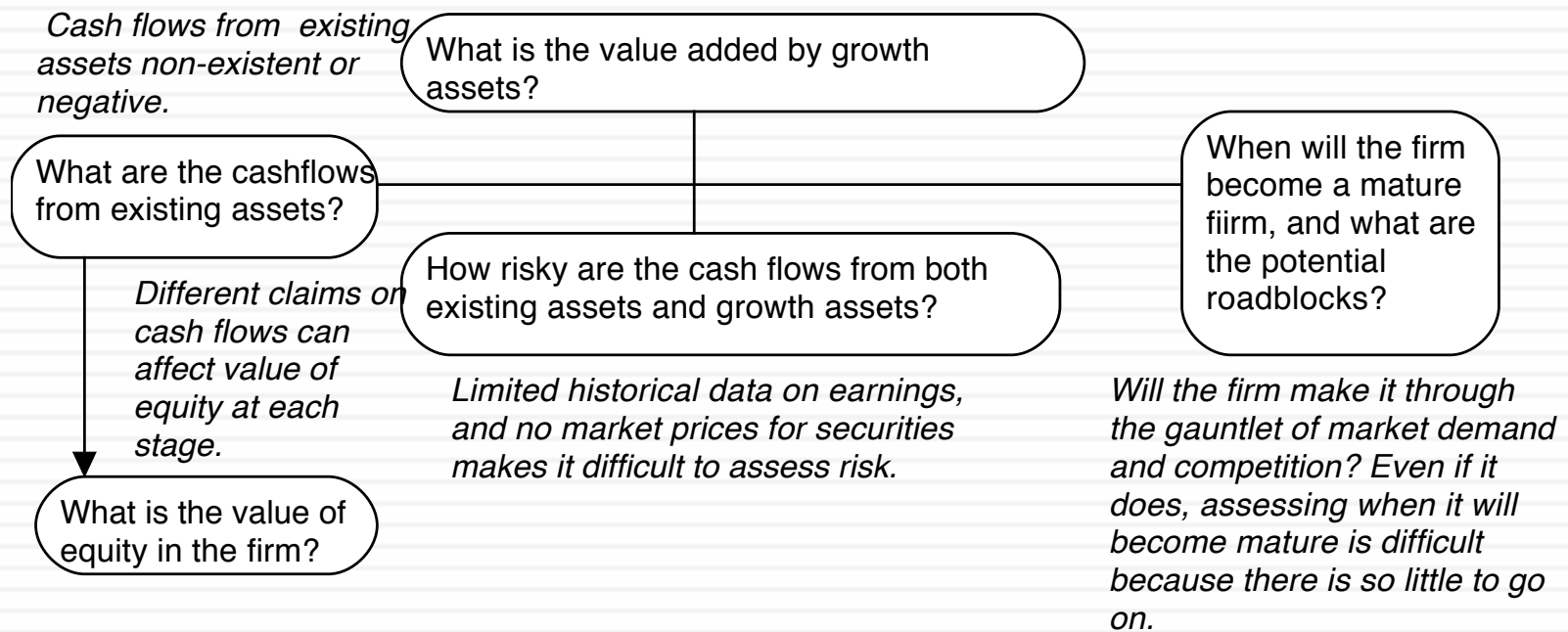

Twitter: Setting the table in October 2013

	Last 10K	Trailing 12 month
Revenues	\$316.93	\$534.46
Operating Income	(\$77.06)	(\$134.91)
Adjusted Operating Income		\$7.66
Invested Capital		\$955.00
Adjusted Operating Margin		1.44%
Sales/ Invested Capital		\$0.56

Twitter: Priming the Pump for Valuation

1. Make small revenues into big revenues

	2011		2012		2013	
	%	\$	%	\$	%	\$
Google	32.09%	\$27.74	31.46%	\$32.73	33.24%	\$38.83
Facebook	3.65%	\$3.15	4.11%	\$4.28	5.04%	\$5.89
Yahoo!	3.95%	\$3.41	3.37%	\$3.51	3.10%	\$3.62
Microsoft	1.27%	\$1.10	1.63%	\$1.70	1.78%	\$2.08
IAC	1.15%	\$0.99	1.39%	\$1.45	1.47%	\$1.72
AOL	1.17%	\$1.01	1.02%	\$1.06	0.95%	\$1.11
Amazon	0.48%	\$0.41	0.59%	\$0.61	0.71%	\$0.83
Pandora	0.28%	\$0.24	0.36%	\$0.37	0.50%	\$0.58
Twitter	0.16%	\$0.14	0.28%	\$0.29	0.50%	\$0.58
Linkedin	0.18%	\$0.16	0.25%	\$0.26	0.32%	\$0.37
Millennial Media	0.05%	\$0.04	0.07%	\$0.07	0.10%	\$0.12
Other	55.59%	\$48.05	55.47%	\$57.71	52.29%	\$61.09
Total Market	100%	\$86.43	100.00%	\$104.04	100.00%	\$116.82

2. Make losses into profits

Company	Operating Margin
Google Inc. (NasdaqGS:GOOG)	22.82%
Facebook, Inc. (NasdaqGS:FB)	29.99%
Yahoo! Inc. (NasdaqGS:YHOO)	13.79%
Netfix	3.16%
Groupon	2.53%
LinkedIn Corporation (NYSE:LNKD)	5.18%
Pandora Media, Inc. (NYSE:P)	-9.13%
Yelp, Inc. (NYSE:YELP)	-6.19%
OpenTable, Inc. (NasdaqGS:OPEN)	24.90%
RetailMeNot	45.40%
Travelzoo Inc. (NasdaqGS:TZOO)	15.66%
Zillow, Inc. (NasdaqGS:Z)	-66.60%
Trulia, Inc. (NYSE:TRLA)	-6.79%
Aggregate	20.40%

		Annual growth rate in Global Advertising Spending				
		2.00%	2.50%	3.00%	3.50%	4.00%
Online advertising share of market	20%	\$124.78	\$131.03	\$137.56	\$144.39	\$151.52
	25%	\$155.97	\$163.79	\$171.95	\$180.49	\$189.40
	30%	\$187.16	\$196.54	\$206.34	\$216.58	\$227.28
	35%	\$218.36	\$229.30	\$240.74	\$252.68	\$265.16
	40%	\$249.55	\$262.06	\$275.13	\$288.78	\$303.04

My estimate for Twitter: Operating margin of 25% in year 10

3. Reinvest for growth

	Sales/ Invested Capital
Twitter (2013)	1.10
Advertising Companies	1.40
Social Media Companies	1.05

My estimate for 2023: Overall online advertising market will be close to \$200 billion and Twitter will have about 5.7% (\$11.5 billion)

My estimate for Twitter: Sales/Capital will be 1.50 for next 10 years

Sweating the small stuff: Risk and Required Return

Risk in the discount rate

My estimate for Twitter

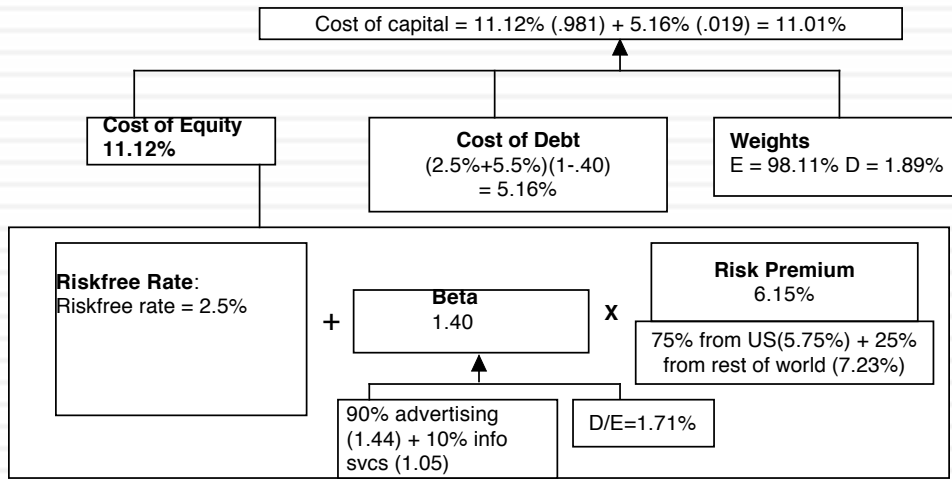

Cost of Capital: US - Nov '13

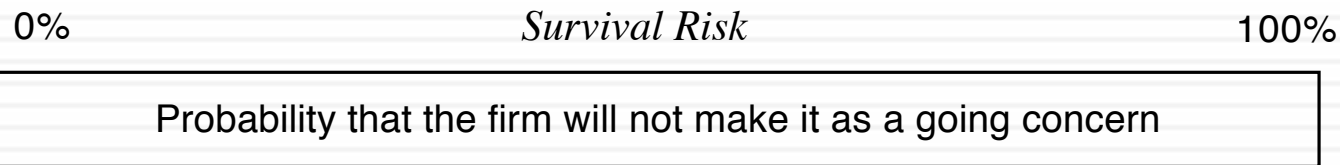
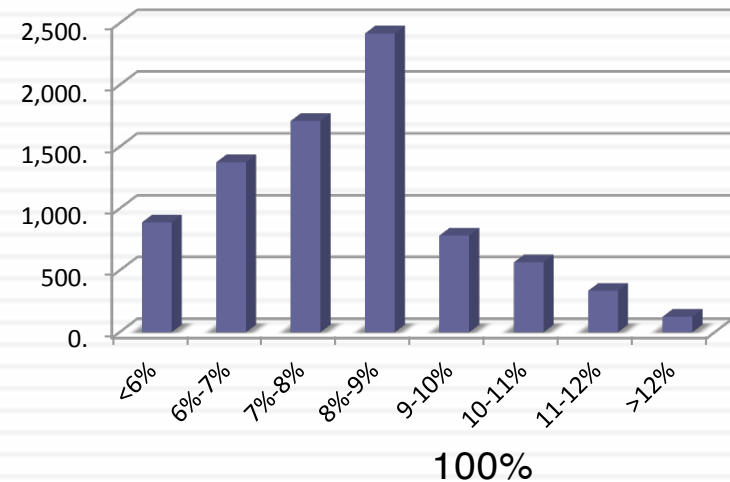

Certain to make it as going concern

Certain to fail

My assumption for Twitter

Starting numbers

	Last 10K	Trailing 12 month
Revenues	\$316.93	\$534.46
Operating income	-\$77.06	-\$134.91
Adjusted Operating Income		\$7.67
Invested Capital		\$955.00
Adjusted Operatng Margin		1.44%
Sales/ Invested Capital		0.56
Interest expenses	\$2.49	\$5.30

Twitter Pre-IPO Valuation: October 27, 2013

Revenue growth of 51.5% a year for 5 years, tapering down to 2.5% in year 10

Pre-tax operating margin increases to 25% over the next 10 years

Sales to capital ratio of 1.50 for incremental sales

Stable Growth
 g = 2.5%; Beta = 1.00;
 Cost of capital = 8%
 ROC = 12%;
 Reinvestment Rate = 2.5%/12% = 20.83%

Terminal Value₁₀ = 1466 / (.08 - .025) = \$26,657

	1	2	3	4	5	6	7	8	9	10
Revenues	\$ 810	\$1,227	\$1,858	\$2,816	\$4,266	\$6,044	\$7,973	\$9,734	\$10,932	\$11,205
Operating Income	\$ 31	\$ 75	\$ 158	\$ 306	\$ 564	\$ 941	\$1,430	\$1,975	\$ 2,475	\$ 2,801
Operating Income after tax	\$ 31	\$ 75	\$ 158	\$ 294	\$ 395	\$ 649	\$ 969	\$1,317	\$ 1,624	\$ 1,807
- Reinvestment	\$ 183	\$ 278	\$ 421	\$ 638	\$ 967	\$1,186	\$1,285	\$1,175	\$ 798	\$ 182
FCFF	\$(153)	\$(203)	\$(263)	\$(344)	\$(572)	\$(537)	\$(316)	\$ 143	\$ 826	\$ 1,625

Terminal year (11)
 EBIT (1-t) \$ 1,852
 - Reinvestment \$ 386
 FCFF \$ 1,466

Operating assets	\$9,705
+ Cash	321
+ IPO Proceeds	1295
- Debt	214
Value of equity	11,106
- Options	713
Value in stock	10,394
/ # of shares	582.46
Value/share	\$17.84

Cost of capital = 11.12% (.981) + 5.16% (.019) = 11.01%

Cost of capital decreases to 8% from years 6-10

Cost of Equity
11.12%

Cost of Debt
(2.5% + 5.5%)(1 - .40)
= 5.16%

Weights
E = 98.1% D = 1.9%

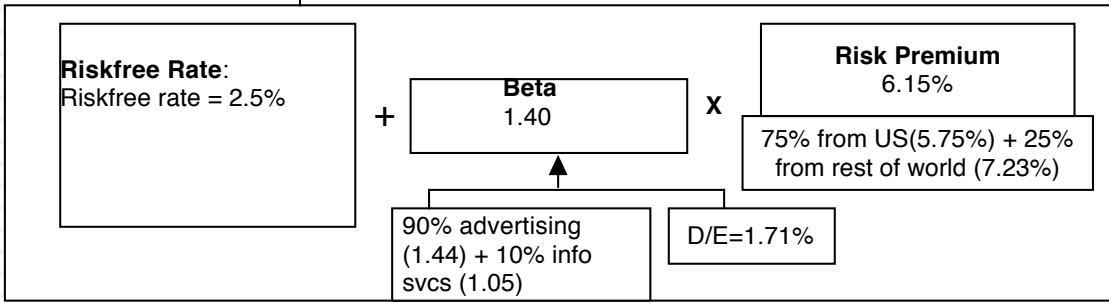

Starting numbers

Twitter Valuation after first earnings report: February 8, 2014

	2013	2012
Revenues	\$664.9	\$316.9
Operating Income	-\$635.8	-\$77.1
Adjusted Operating Income	-\$147.0	-\$7.7
Invested Capital	\$1,816.0	
Adjusted Operating Margin	-\$0.2	
Sales/Invested Capital	\$0.8	

Revenue growth of 50% a year for 5 years, tapering down to 2.75% in year 10

Pre-tax operating margin increases to 25% over the next 10 years

Sales to capital ratio of 1.50 for incremental sales

Stable Growth
 $g = 2.75\%$;
 Cost of capital = 8%
 $ROC = 12\%$;
 Reinvestment Rate = $2.75\%/12\% = 22.92\%$

Terminal Value₁₀ = $1666 / (.08 - .025) = \$31,741$

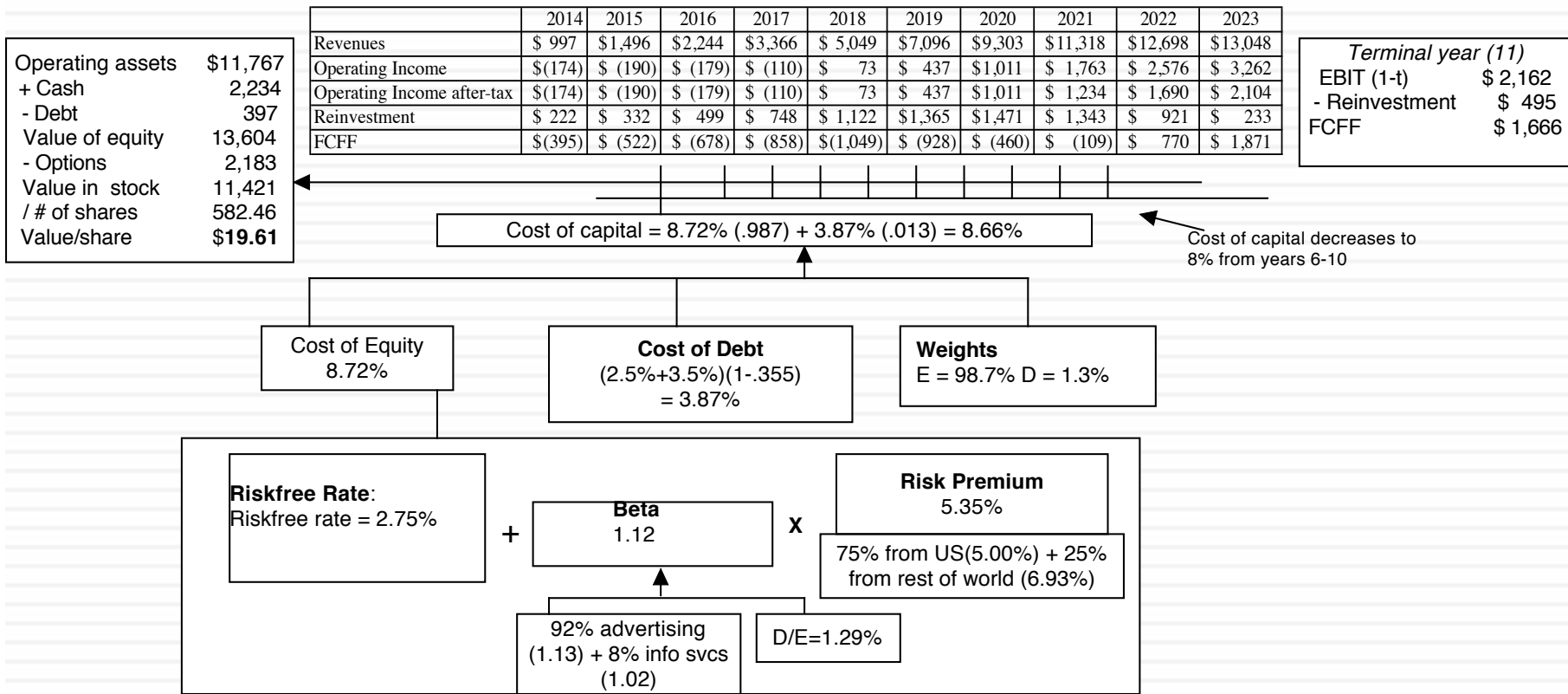

Poll Question 6: The “terminal value”

35

- In the valuation of Twitter, more than a 100% of the value today comes from the terminal value. Which of the following best characterizes your reaction to this finding?
 - a. The DCF is obviously wrong. You cannot get more than 100% of value from the terminal value.
 - b. Since your value is coming entirely from your terminal value, it does not matter what you assume during your high growth phase.
 - c. There is nothing wrong with the DCF. It reflects how you will earn your returns on an investment in a young company.

If your job is enhancing value, it's got to come from changing the fundamentals

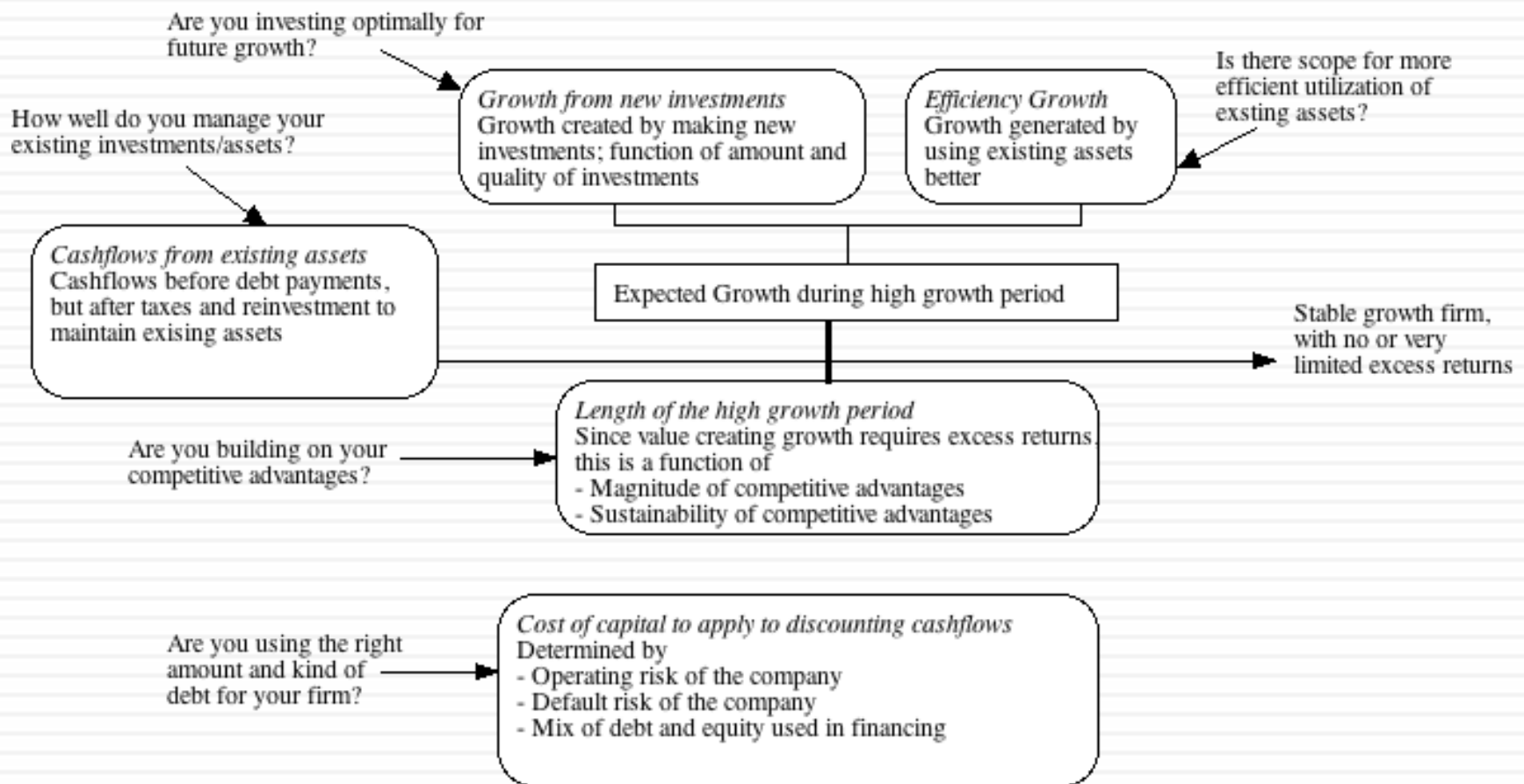

Increase Cash Flows

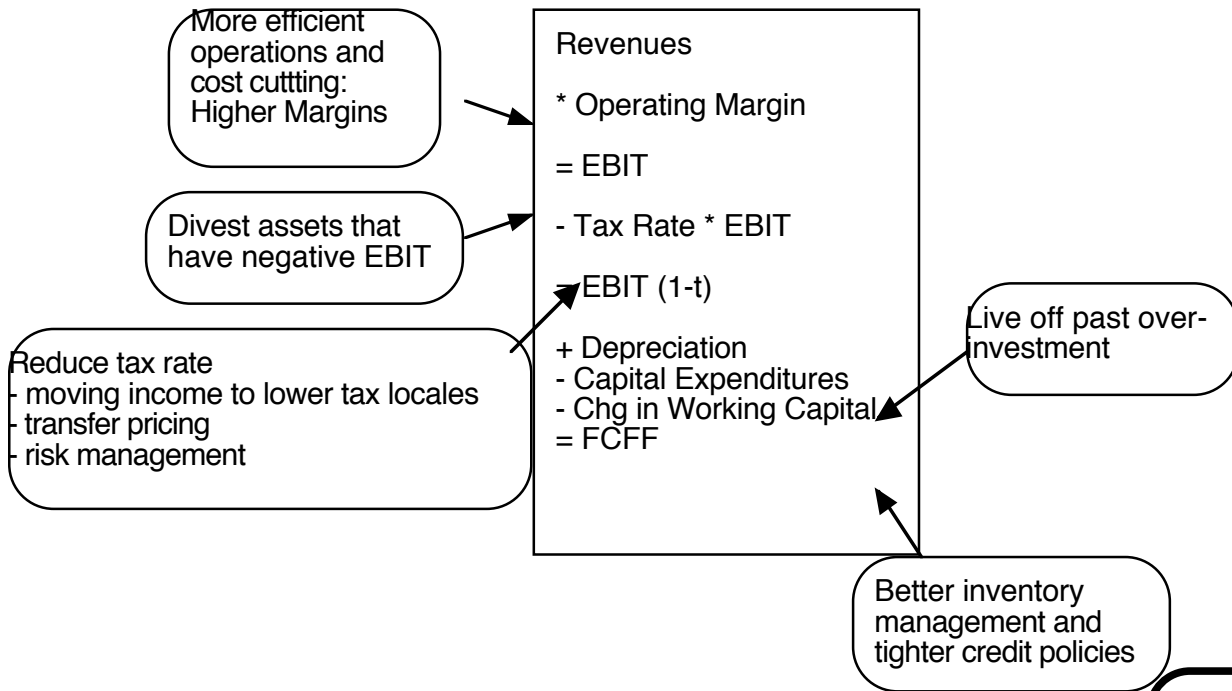

Reduce the cost of capital

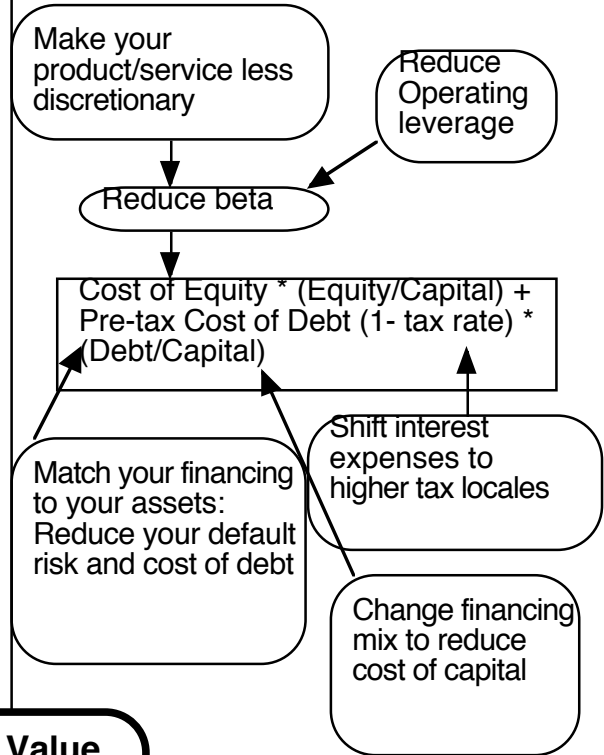

Firm Value

Increase Expected Growth

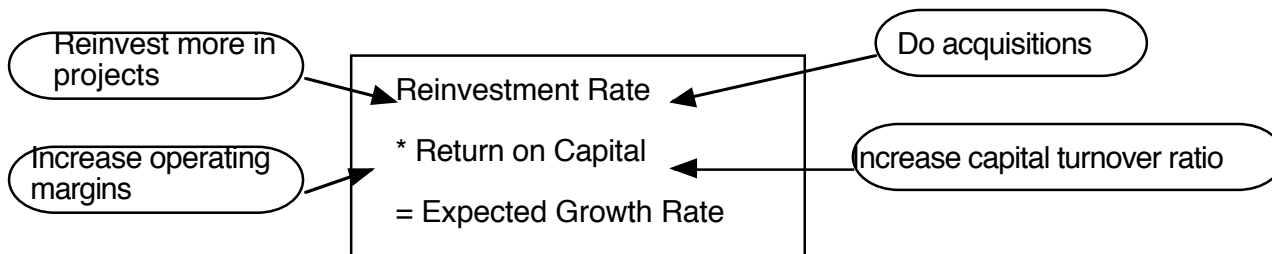

Increase length of growth period

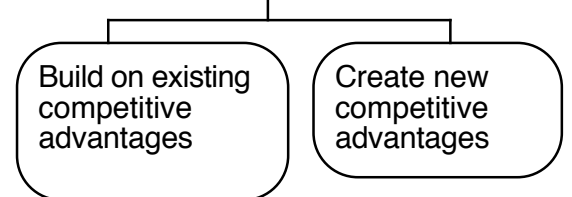

Disney (Restructured)- November 2013

Current Cashflow to Firm
 EBIT(1-t)= 10,032(1-.31)= 6,920
 - (Cap Ex - Deprecn) 3,629
 - Chg Working capital 103
 = FCFF 3,188
 Reinvestment Rate = 3,732/6920
 =53.93%
 Return on capital = 12.61%

Reinvestment Rate
50.00%

More selective acquisitions & payoff from gaming

Return on Capital
14.00%

Expected Growth
.50* .14 = .07 or 7%

Stable Growth
 g = 2.75%; Beta = 1.20;
 Debt %= 40%; k(debt)=3.75%
 Cost of capital =6.76%
 Tax rate=36.1%; ROC= 10%;
 Reinvestment Rate=2.5/10=25%

Op. Assets 147,704
 + Cash: 3,931
 + Non op inv 2,849
 - Debt 15,961
 - Minority Int 2,721
 =Equity 135,802
 -Options 869
Value/Share \$ 74.96

	First 5 years					Growth declines gradually to 2.75%				
	1	2	3	4	5	6	7	8	9	10
EBIT * (1 - tax rate)	\$7,404	\$7,923	\$8,477	\$9,071	\$9,706	\$10,298	\$10,833	\$11,299	\$11,683	\$11,975
- Reinvestment	\$3,702	\$3,961	\$4,239	\$4,535	\$4,853	\$4,634	\$4,333	\$3,955	\$3,505	\$2,994
Free Cashflow to Firm	\$3,702	\$3,961	\$4,239	\$4,535	\$4,853	\$5,664	\$6,500	\$7,344	\$8,178	\$8,981

Terminal Value₁₀ = 9,206 / (.0676 - .025) = 216,262

Term Yr
 12,275
 3,069
 9,206

Cost of Capital (WACC) = 8.52% (0.60) + 2.40%(0.40) = 7.16%

Cost of capital declines gradually to 6.76%

Cost of Equity
10.34%

Cost of Debt
 (2.75%+1.00%)(1-.361)
 = 2.40%
 Based on synthetic A rating

Weights
 E = 60% D = 40%

In November 2013, Disney was trading at \$67.71/share

Move to optimal debt ratio, with higher beta.

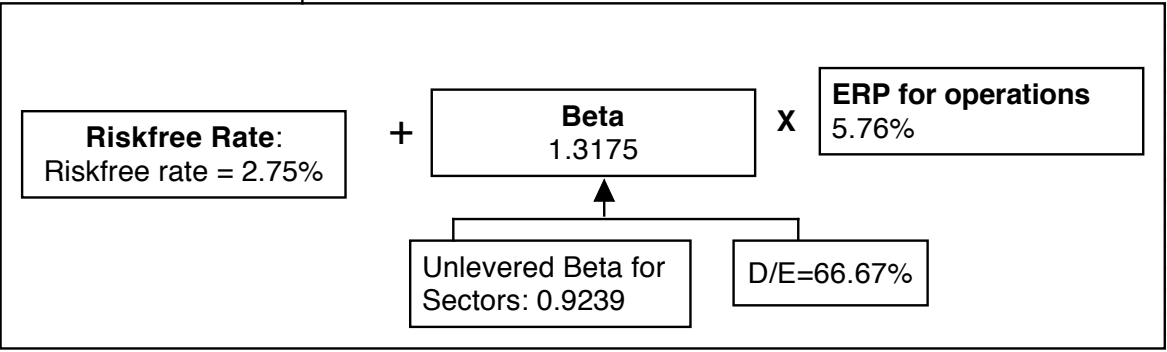

And intrinsic value can change a lot, especially for young companies & in market crisis

Company-specific	<p>1. <u>Company</u>: The most obvious source of information is the company itself, with earnings reports being the most frequently used vehicle for delivery of that information.</p> <p>2. <u>Outsiders</u>: Some company-specific information is unearthed by investors and analysts in the course of doing research on the company, without accessing either company insiders or proprietary corporate data.</p>
Sector-wide	<p>1. <u>Other companies in the sector</u>: Earnings and investment announcements by other companies in the sector can be used to reassess investor expectations of market potential and profitability.</p> <p>2. <u>Sector research</u>: There are sector experts and consultants whose job it is to collect information about the overall sector and analyze it, with the intent of assessing sector trends and prospects.</p>
Macro economic	<p>1. <u>Government</u>: The biggest source of macroeconomic data (interest rates, inflation, economic growth) is the government through its many institutions.</p> <p>2. <u>Private entities</u>: There are private entities that also generate macroeconomic data that markets react to. In the US, for instance ADP (a publicly traded company) produces a monthly national employment report and the Conference Board reports a composite index of leading economic indicators.</p>

My first try: Tesla Valuation: September/October 2013

Starting numbers

	Last 12 months	Prior year
Revenues	1329	413
Operating Income	-217	394
Adj. Operating Income	\$ (22.00)	
Invested Capital	1006	
Adj. Operating Margin	-1.66%	
Sales/Capital Ratio	1.32	

Revenue growth of 70% a year for 5 years, tapering down to 2.75% in year 10

Pre-tax operating margin increases to 12.5 % over the next 10 years

Sales to capital ratio of 1.41 for incremental sales

Stable Growth
 $g = 2.75\%$; $\text{Beta} = 1.00$;
 Cost of capital = 8%
 $\text{ROC} = 8\%$;
 $\text{Reinvestment Rate} = 2.75\%/8\% = 34.38\%$

Terminal Value₁₀ = $3,584 / (.08 - .0275) = \$68,271$

PV adjusted for 10% chance of failure and proceeds = 50% of estimated value, if that happens.

Operating assets	\$12,174
+ Cash	202
- Debt	579
Value of equity	11,797
- Options	3,645
Value in stock	8,152
/ # of shares	121.45
Value/share	\$67.12

	1	2	3	4	5	6	7	8	9	10
Revenues	\$2,259	\$3,840	\$6,528	\$11,097	\$18,866	\$29,534	\$42,263	\$54,794	\$63,671	\$65,422
EBIT (1-t)	-\$5	\$45	\$170	\$445	\$1,024	\$1,879	\$3,001	\$4,186	\$5,082	\$5,316
- Reinvestment	\$660	\$1,121	\$1,906	\$3,241	\$5,509	\$7,566	\$9,028	\$8,887	\$6,296	\$1,242
= FCFF	-\$665	-\$1,076	-\$1,737	-\$2,795	-\$4,485	-\$5,687	-\$6,027	-\$4,701	-\$1,214	\$4,074

Terminal year (11)	
EBIT (1-t)	\$ 5,462
- Reinvestment	\$1,877
FCFF	\$ 3,584

Cost of capital = $10.18\% (.974) + 4.55\% (.026) = 10.03\%$

Cost of capital decreases to 8% from years 6-10

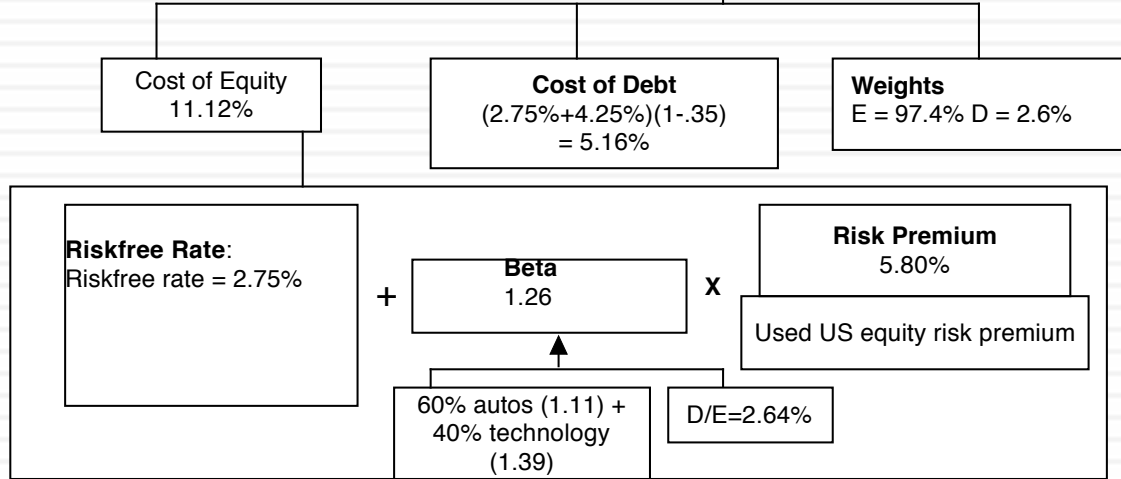

An update: Tesla Valuation: March 2014

Starting numbers

End revenues \$14 billion higher & margins slightly lower due to entering battery market

	2013	2012
Revenues	\$ 2,013.50	\$ 413.30
Operating income or EBIT	\$ (61.28)	\$ (395.46)
Adjusted Operating income	-16.83	
Invested Capital	\$1,015	
Adjusted Operating margin	-0.84%	

Revenue growth of 65% a year for 5 years, tapering down to 2.75% in year 10

Pre-tax operating margin increases to 12% over the next 10 years

Sales to capital ratio of 1.55 for incremental sales

Stable Growth
 $g = 2.75\%$; $\text{Beta} = 1.00$;
 Cost of capital = 8%
 $\text{ROC} = 8\%$;
 $\text{Reinvestment Rate} = 2.75\%/8\% = 34.38\%$

Terminal Value₁₀ = $4,182 / (.08 - .0275) = \$79,664$

Assumed no chance of failure, because of improved access to capital

Operating assets	\$16,636
+ Cash	846
- Debt	739
Value of equity	16,742
- Options	4,381
Value in stock	12,362
/ # of shares	123.19
Value/share	\$100.35

Year	1	2	3	4	5	6	7	8	9	10
Revenues	\$3,322	\$ 5,482	\$ 9,045	\$14,924	\$24,625	\$37,565	\$52,629	\$67,180	\$77,392	\$79,520
EBIT (1-t)	\$ 7	\$ 84	\$ 254	\$ 403	\$ 874	\$ 1,652	\$ 2,762	\$ 4,097	\$ 5,378	\$ 6,203
- Reinvestment	\$ 844	\$ 1,393	\$ 2,299	\$ 3,793	\$ 6,258	\$ 8,349	\$ 9,718	\$ 9,388	\$ 6,588	\$ 1,373
FCFF	\$ (837)	\$(1,309)	\$(2,044)	\$(3,390)	\$(5,385)	\$(6,696)	\$(6,956)	\$(5,291)	\$(1,210)	\$ 4,829
Invested Capital	\$1,889	\$ 3,282	\$ 5,581	\$ 9,374	\$15,632	\$23,981	\$33,699	\$43,088	\$49,676	\$51,049
ROIC	0.40%	2.56%	4.56%	4.29%	5.59%	6.89%	8.20%	9.51%	10.83%	12.15%

Terminal year (11)

EBIT (1-t)	\$ 6,373
- Reinvestment	\$2,191
FCFF	\$4,182

Cost of capital = 8.87% (.9734) + 3.90% (.0266) = 8.74%

Cost of capital decreases to 8% from years 6-10

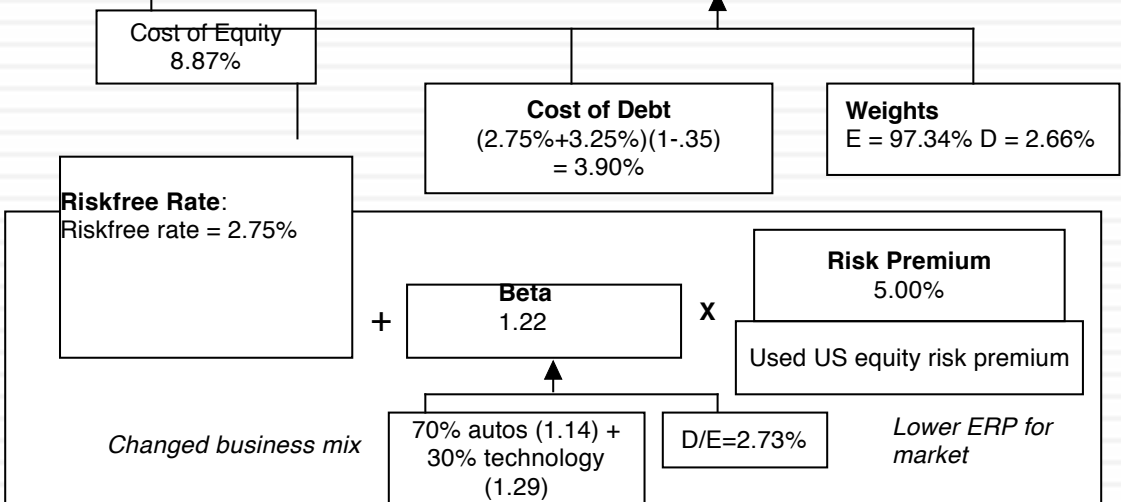

Stock was trading at \$170/ share at the time of the valuation.

Three simple suggestions to make you better at estimating intrinsic value!

42

1. Be honest about your biases/preconceptions: The biggest bogeyman in most valuations is that your preconceptions and biases will lead your choices. While you can never be unbiased, being aware of your biases can help.
2. Keep it simple: Less is more in valuation. While it is easy to build bigger models and you have more access to data, parsimonious valuations often do a better job than complex ones.
3. Face up to uncertainty: Uncertainty is a feature, not a bug. Make the best estimates you can, with the information you have, recognize that everyone else faces the same uncertainty and understand that you don't have to be right, just less wrong than everyone else.



PRICING
IT'S DEMAND AND SUPPLY



The determinants of price

44

Mood and Momentum

Price is determined in large part by mood and momentum, which, in turn, are driven by behavioral factors (panic, fear, greed).

Liquidity & Trading Ease

While the value of an asset may not change much from period to period, liquidity and ease of trading can, and as it does, so will the price.

The Market Price

Incremental information

Since you make money on price changes, not price levels, the focus is on incremental information (news stories, rumors, gossip) and how it measures up, relative to expectations

Group Think

To the extent that pricing is about gauging what other investors will do, the price can be determined by the "herd".

1a. The Momentum Game

45

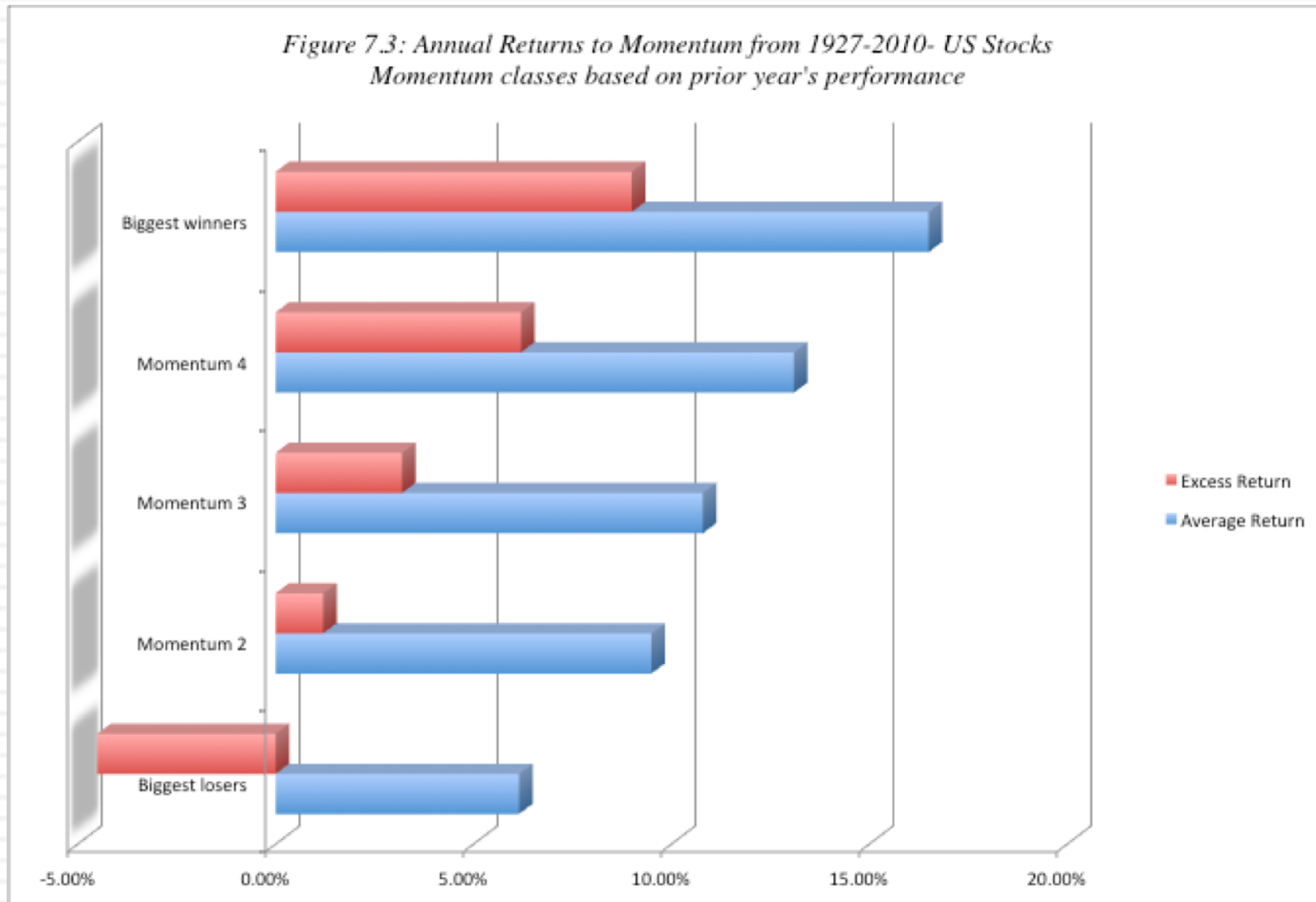

With inflection points

Figure 7: Differential Returns - Winner versus Loser Portfolios

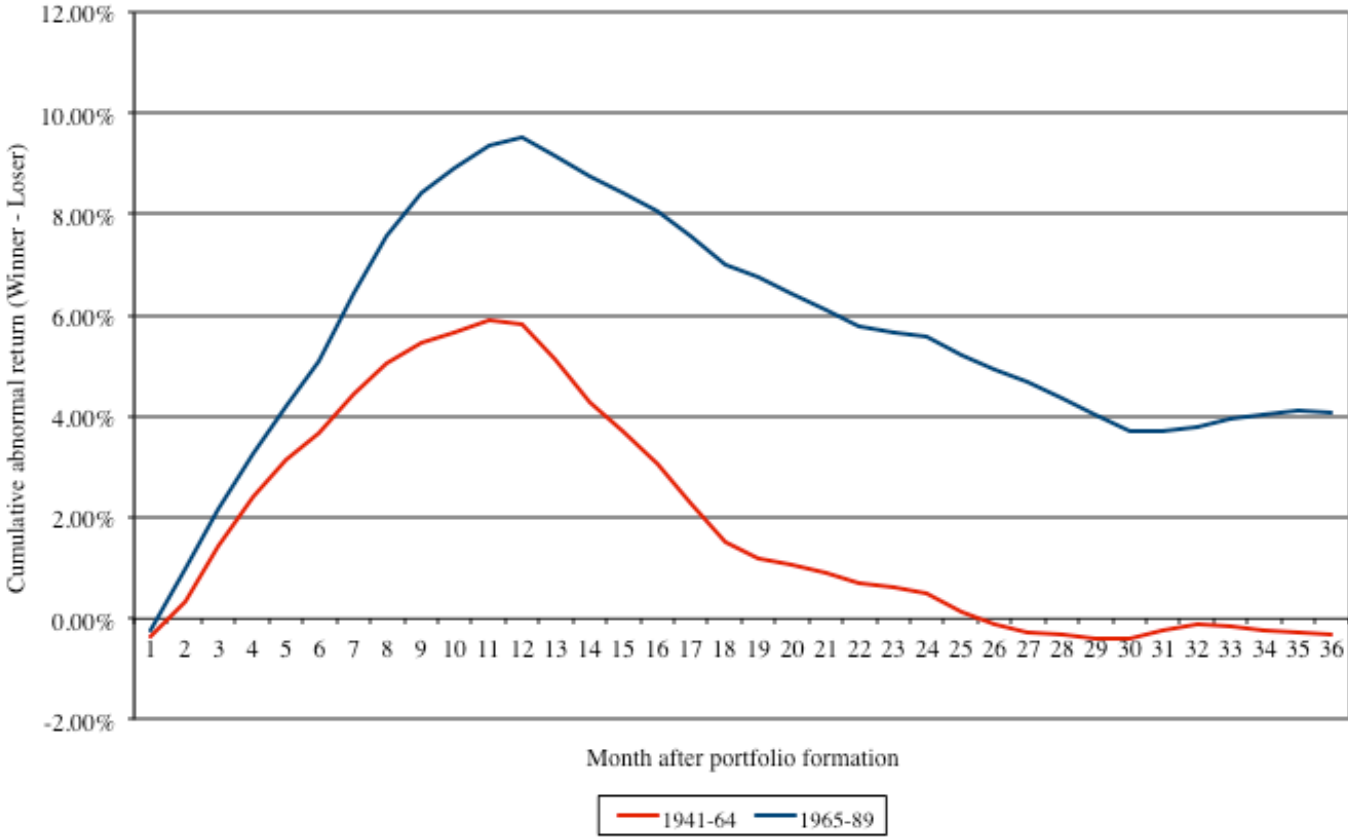

The momentum game works, until it does not...

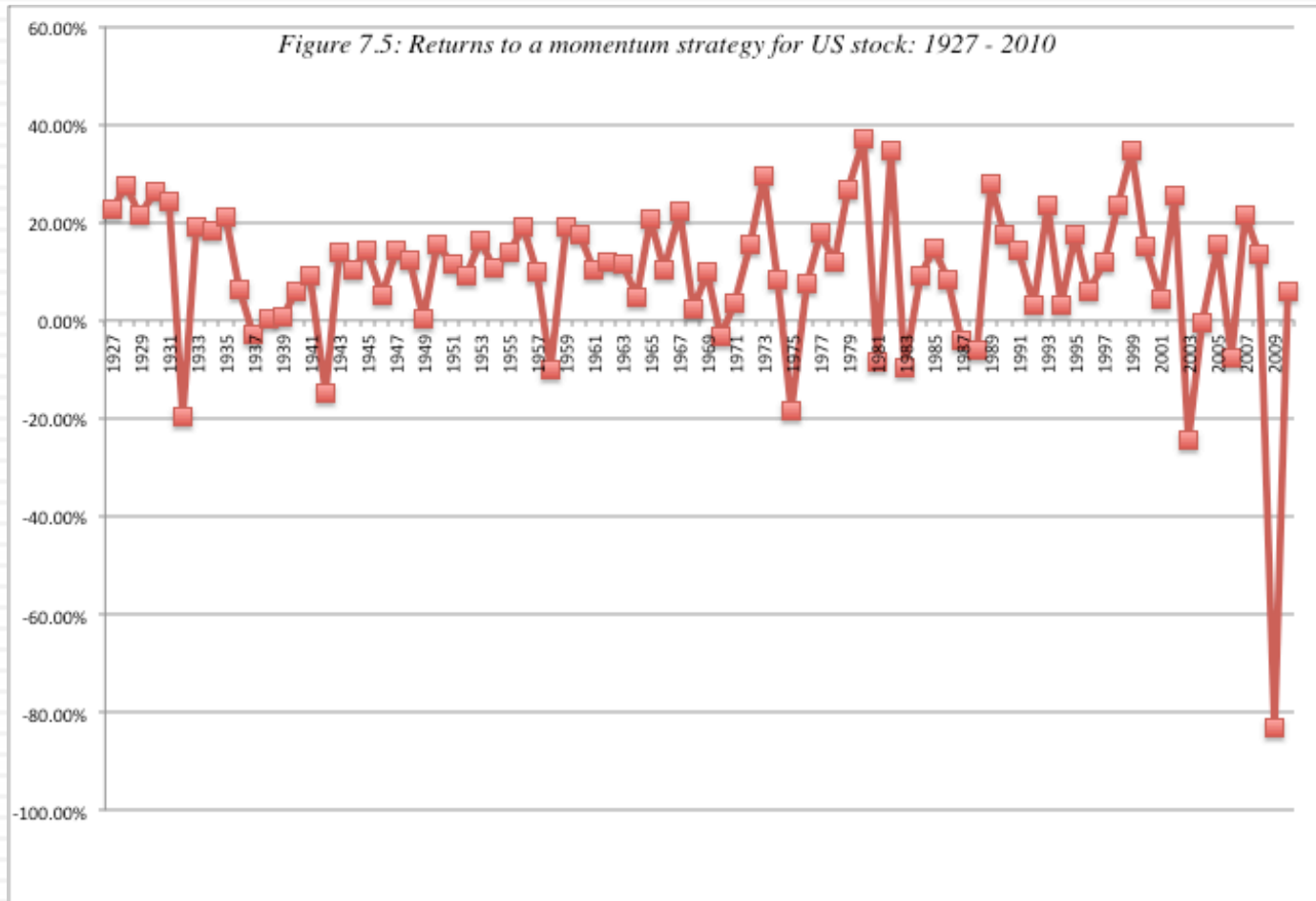

1b. Mood matters

48

Used a computer algorithm & 9.7 million tweets to see if you can predict movements in the Dow 30. Find 87% correlation

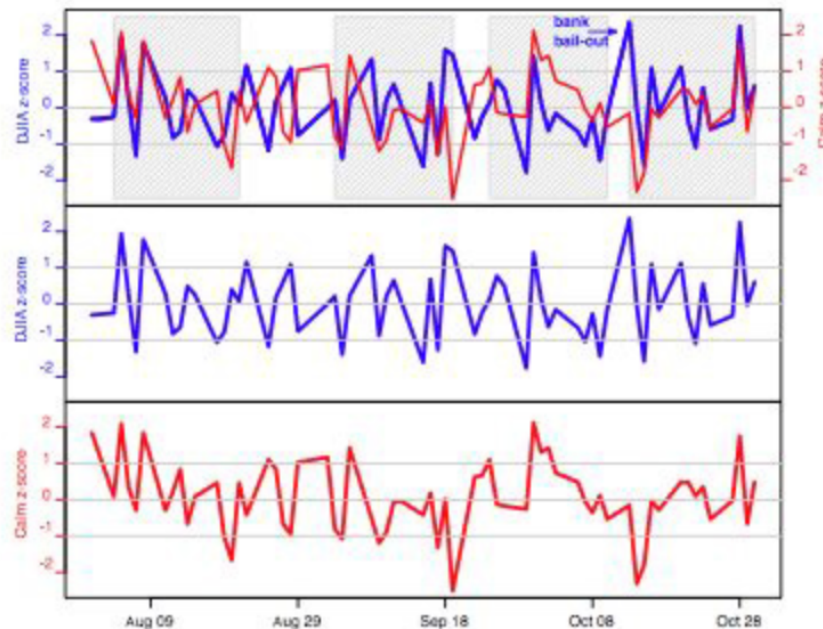
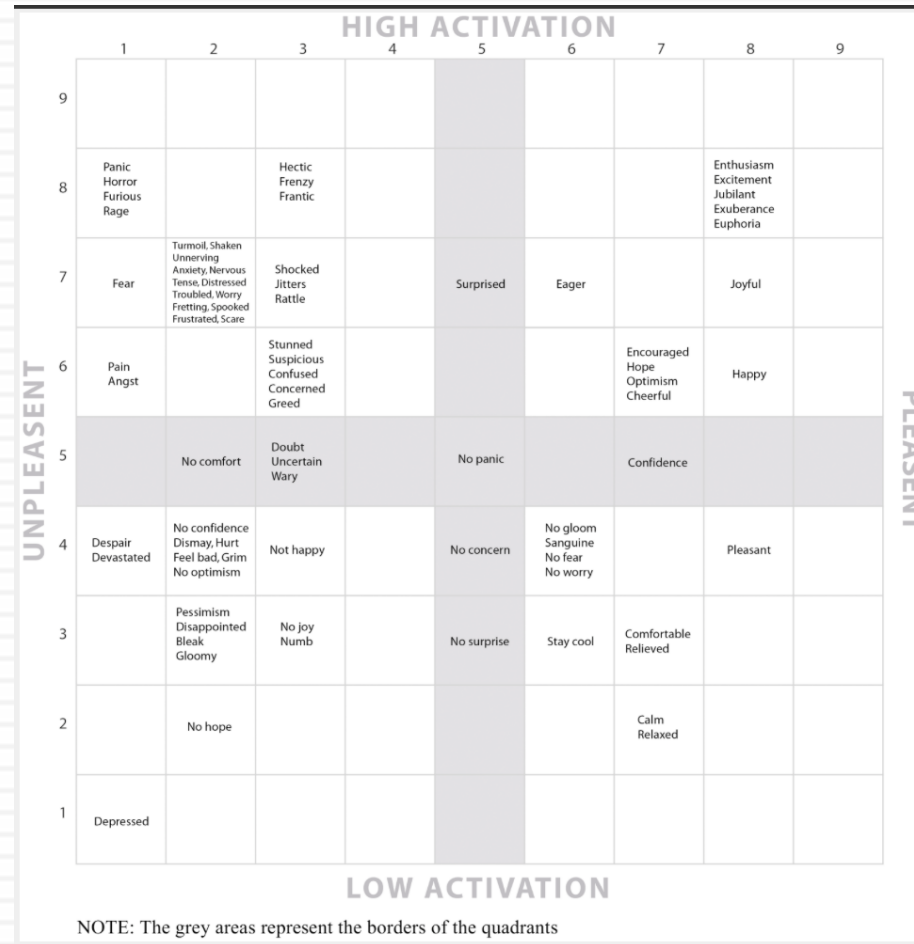

Fig. 3. A panel of three graphs. The top graph shows the overlap of the day-to-day difference of DJIA values (blue: Z_{D_t}) with the GPOMS' Calm time series (red: Z_{X_t}) that has been lagged by 3 days. Where the two graphs overlap the Calm time series predict changes in the DJIA closing values that occur 3 days later. Areas of significant congruence are marked by gray areas. The middle and bottom graphs show the separate DJIA and GPOMS' Calm time series.

Mood inducing words

49



And pricing consequences...

	Prior Day Closing Price Control		Pleasant Mood Univariate		Unpleasant Mood Univariate		Full Multivariate Model	
	B	T-value	B	T-value	B	T-value	B	T-value
<i>Market</i>								
Prior day closing price	-.001	-.61	-.002	-2.14*	.0008	4.47**	-.0003	-.20
<i>Mood</i>								
Pleasant mood			196.46	3.72**			345.49	6.45**
Unpleasant mood					-194.77	-6.25**	-235.72	-6.65**
Variance of dependent variable			13378		13378		13378	
Residual variance			12730		12634		11018	
% of Variance Modeled			4.84%		5.56%		17.64%	

Notes. N = 251 days of NASDAQ price data.

*p < .05.

**p < .01.

All analyses include ARIMA(3,0,3) terms.

doi:10.1371/journal.pone.0072031.t003

Word Search and Value Consequences

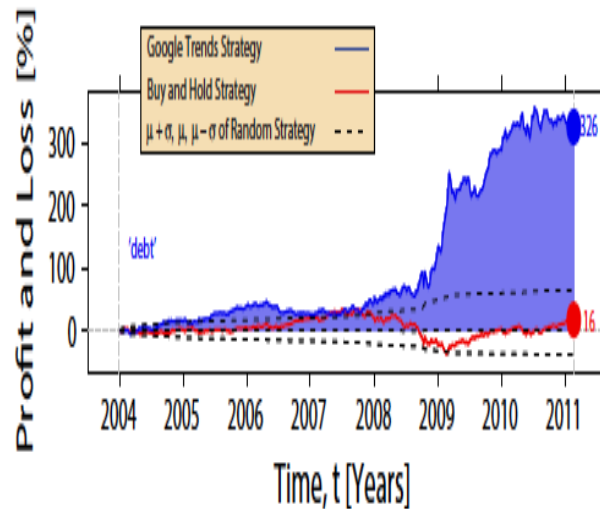
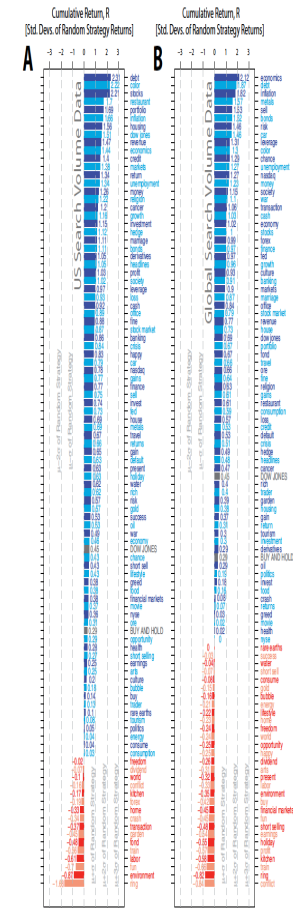

Figure 2 | Cumulative performance of an investment strategy based on Google Trends data. Profit and loss for an investment strategy based on the volume of the search term *debt*, the best performing keyword in our analysis, with $\Delta t = 3$ weeks, plotted as a function of time (blue line). This is compared to the “buy and hold” strategy (red line) and the standard deviation of 10,000 simulations using a purely random investment strategy (dashed lines). The Google Trends strategy using the search volume of the term *debt* would have yielded a profit of 326%.



Another mood experiment: The market and sporting outcomes

52

Abnormal Stock Returns and Soccer Game Outcomes: Top Seven Soccer Nations

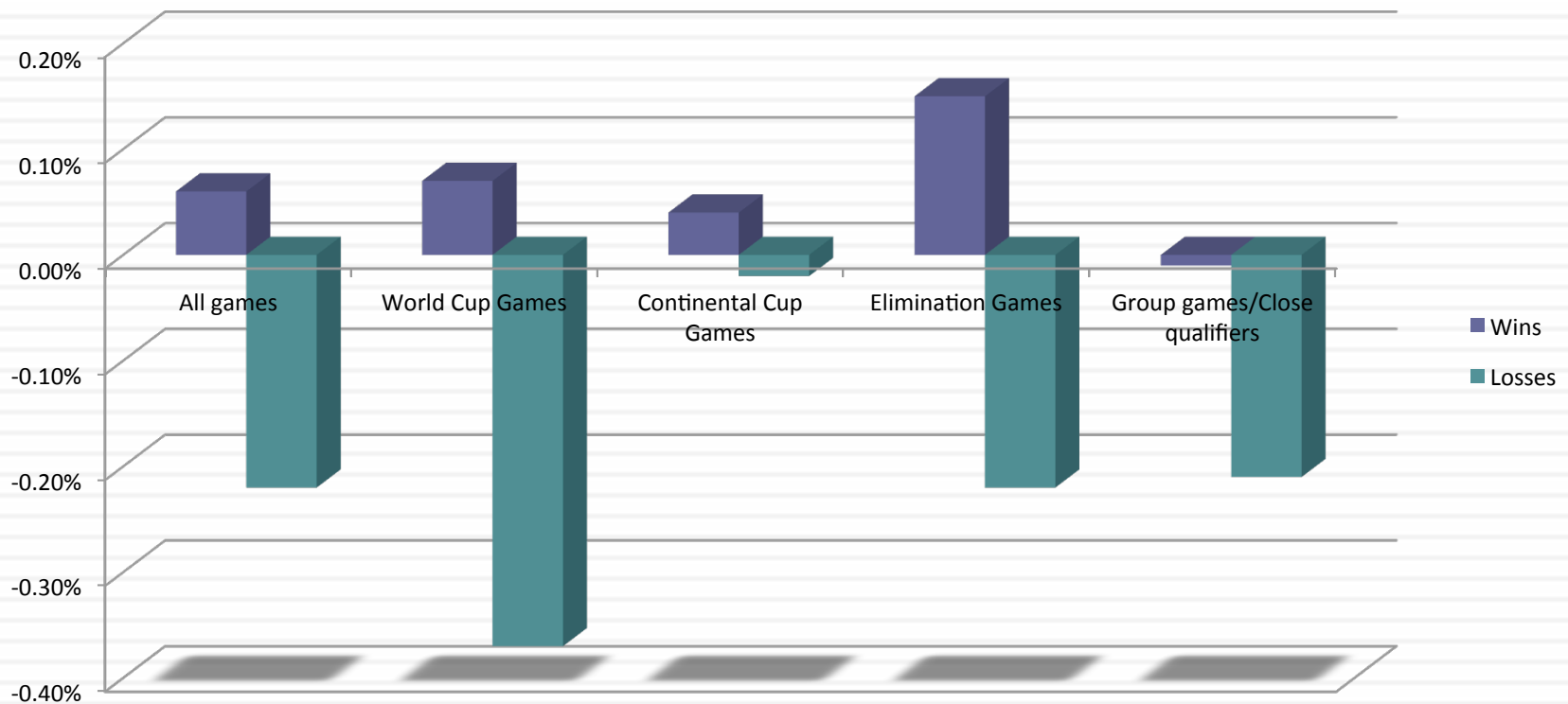

2. Liquidity & Volume

53

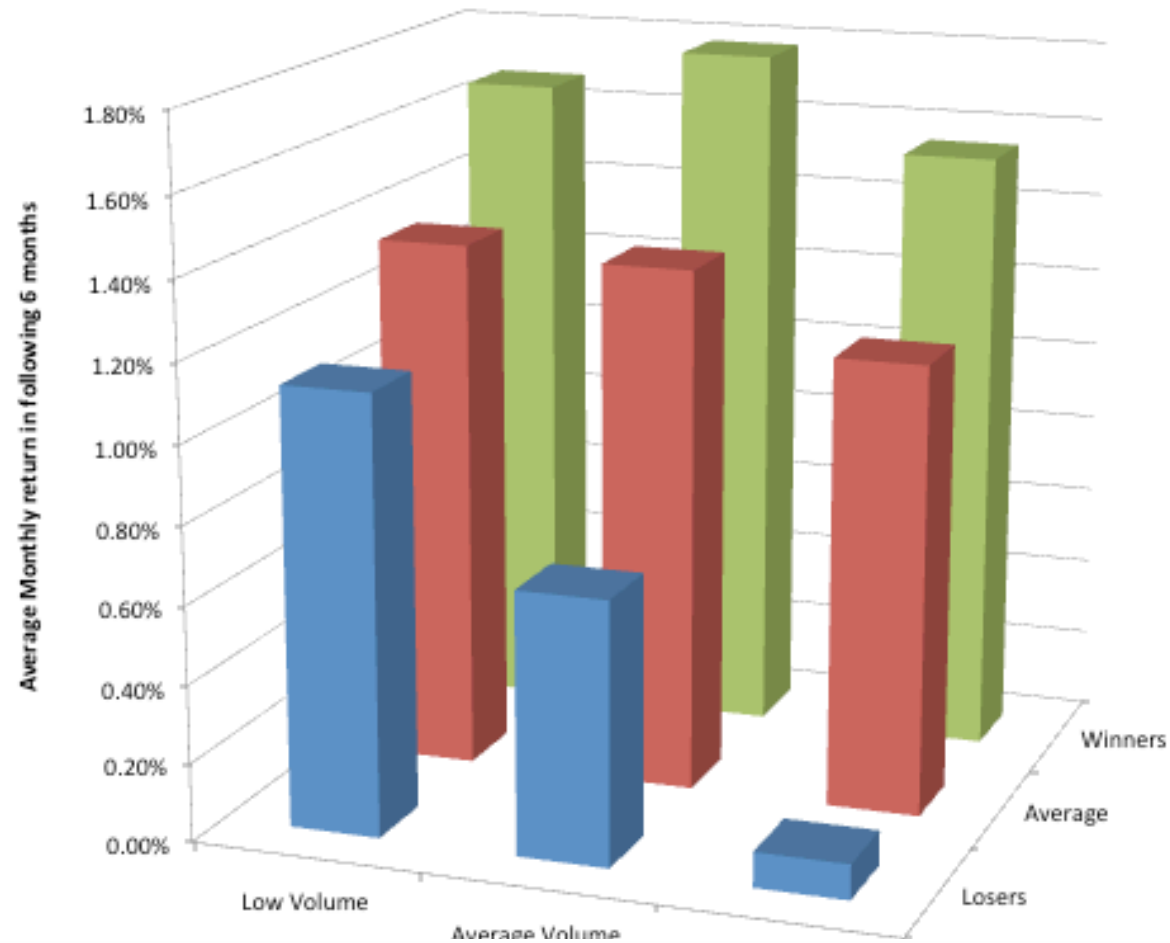

If you are pricing, illiquidity has to be explicitly factored in..

54

- If you are pricing an illiquid asset, relative to another similar liquid asset, you should attach a lower price to it. The extent of the discount has to be based on what the market is charging for illiquidity.
- When the price of liquidity rises in a market (as it does during market crises), and your job is pricing, you should adjust your pricing to reflect that illiquidity.
- The question of whether the illiquidity discount is fair or unfair, rational or irrational is none of your concern.

Poll Question 7: The Illiquidity Discount – Value or Pricing Effect?

55

- In many valuations (?) of private businesses, the estimated values are discounted to reflect the illiquidity in the market for these businesses? How would you characterize this illiquidity discount?
 - a. A discount on value
 - b. A discount on price
- What are the implications?

3. Incremental Information

56

- Prices react to information announcements, and usually in response to how the reports measure up to expectations.
- In some cases, the information contained in the report may have little or even no relevance for value but prices can react disproportionately (relative to how much or how little the value has changed).

Looking at earnings reports

57

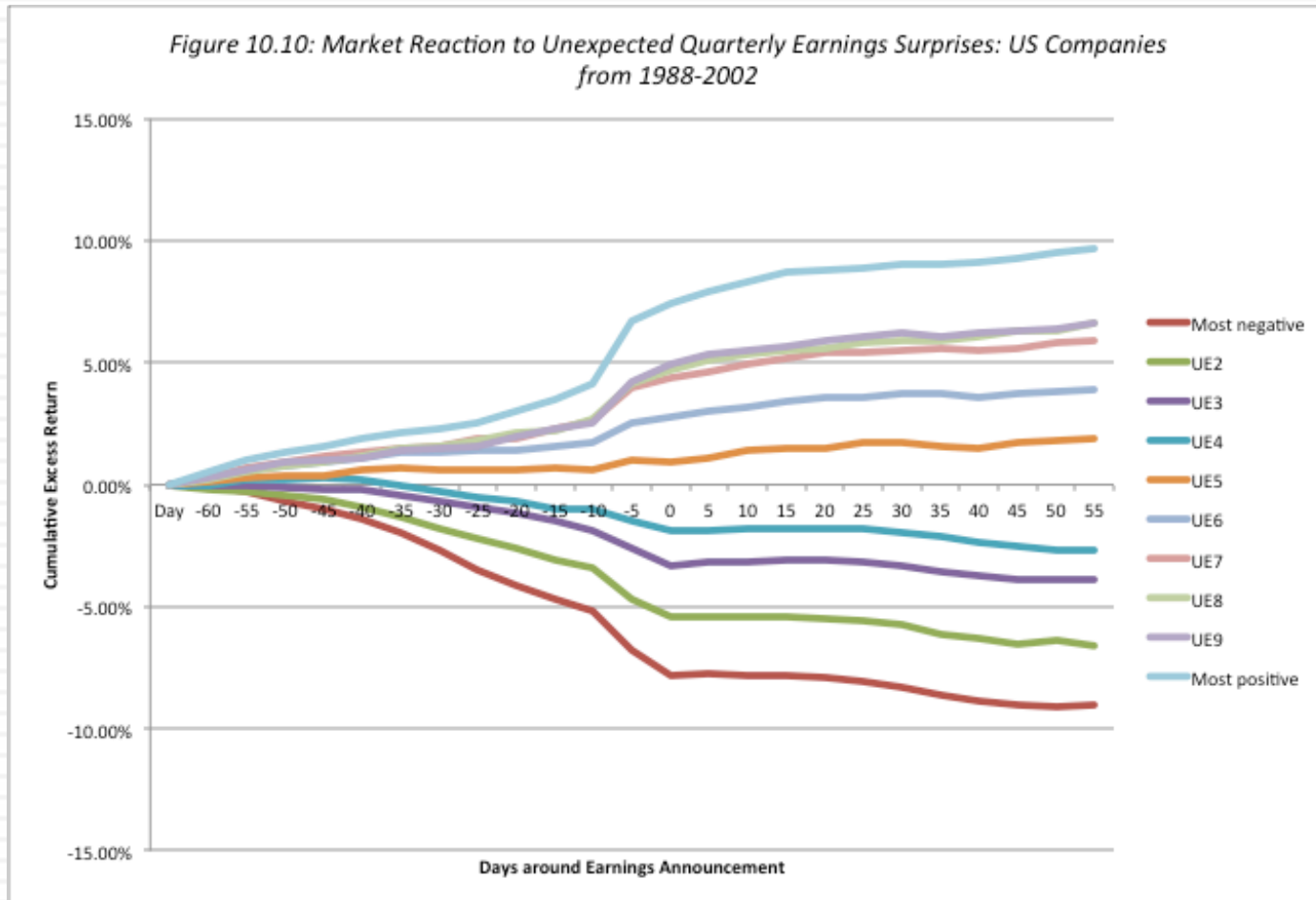

And the post-announcement drift

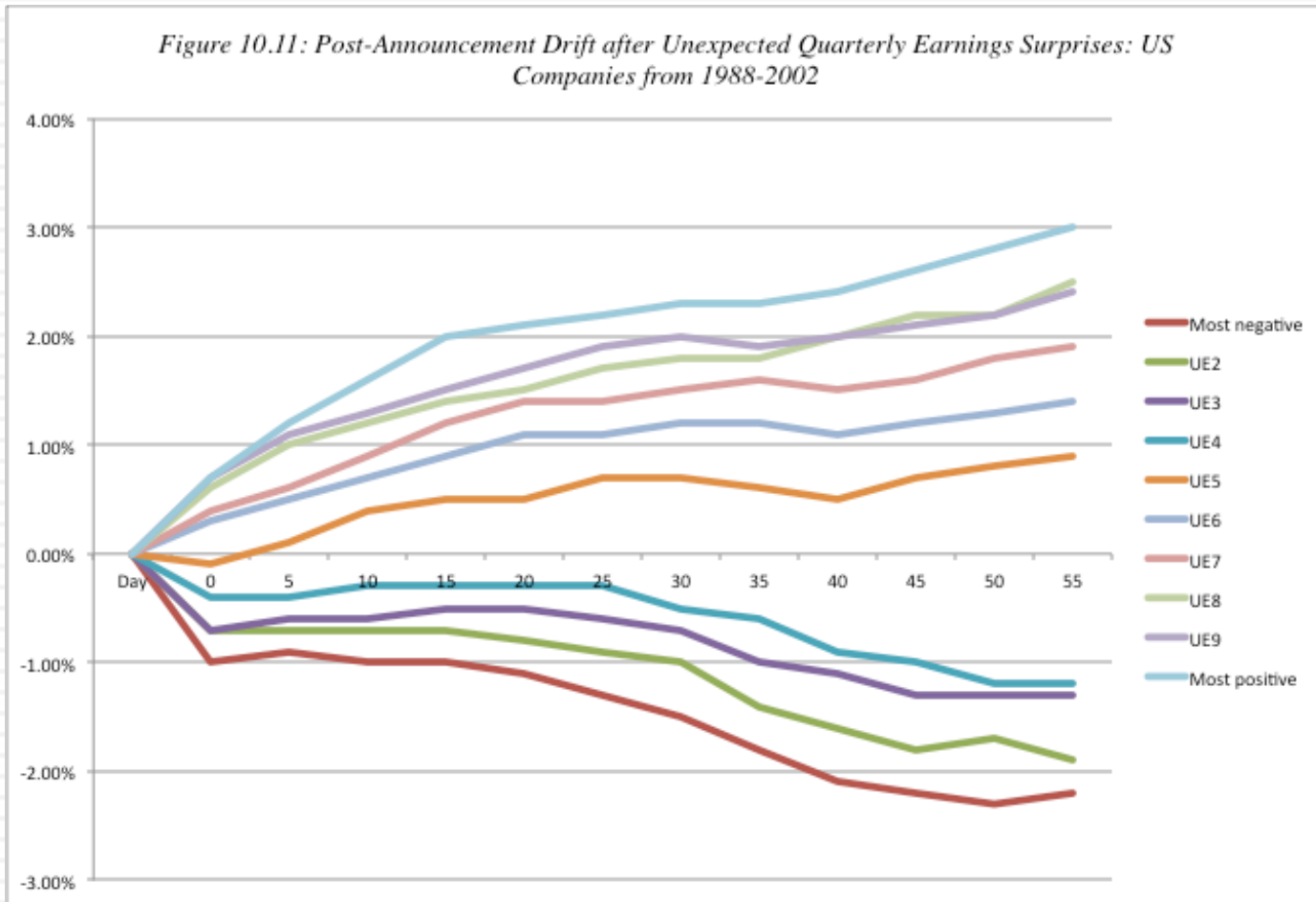

4. The Herd Mentality

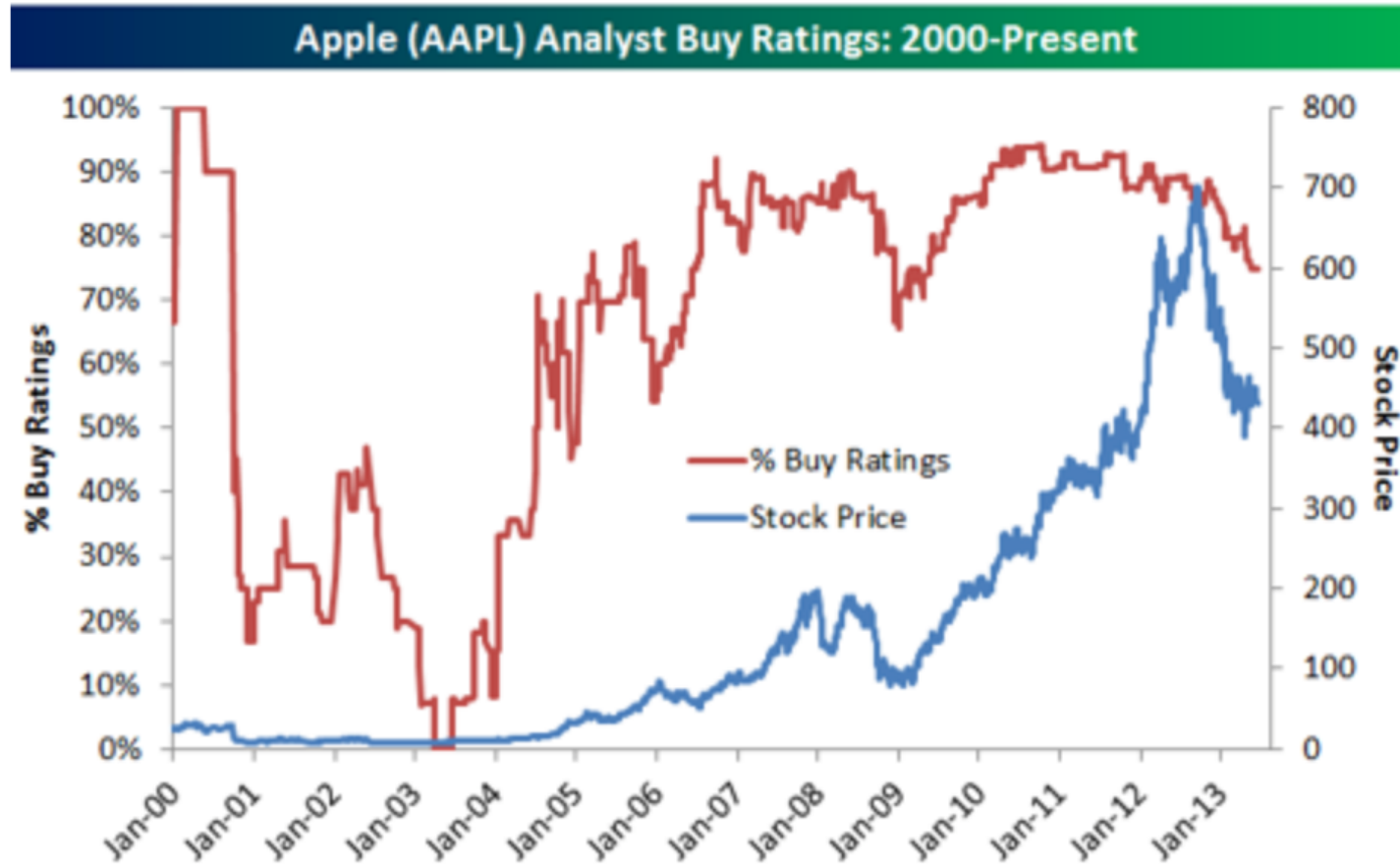

The Pricing Tool Box

60

- If your job is pricing or you are a trader, your success or failure will rest in large part on gauging mood/momentum, adjusting for illiquidity and looking at incremental information.
- The tools you bring in to make these assessments are therefore different from the ones you bring into the valuation game. They can include:
 - ▣ Charts and technical indicators
 - ▣ Preferential access (legal or illegal) to incremental information
 - ▣ Liquidity games (short squeezes)
 - ▣ Pricing metrics (multiples/comparables)

1. Technical Analysis & Charting: It's not (always) mumbo jumbo

61



2. Access to incremental information

62

Time = Money | Superfast traders can act on market-moving news before other investors

High-speed traders pay to get news releases directly from companies, like Business Wire, that distribute them on behalf of public companies and government entities.

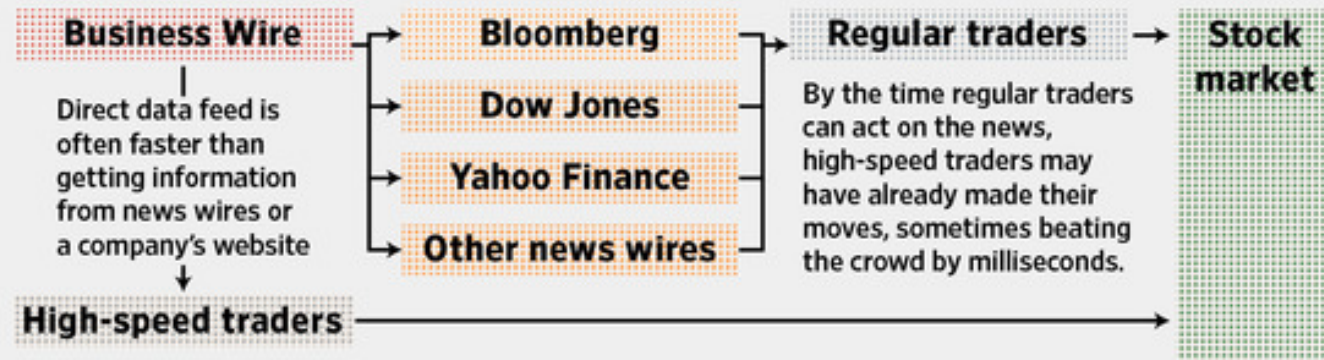

Last December, high-speed traders acted within 50 milliseconds to sell the stock of a company with disappointing earnings news.

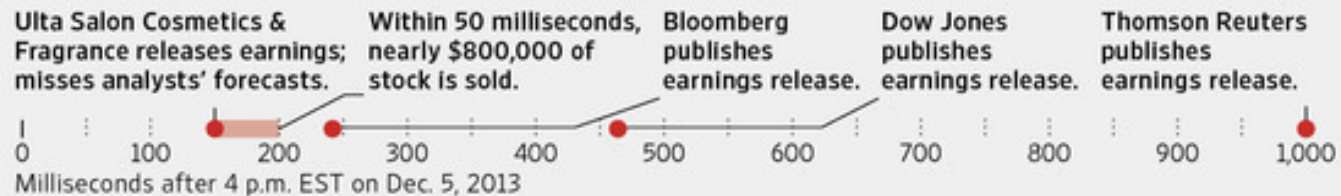

Sources: Bloomberg, Dow Jones and Thomson Reuters (publication times)

The Wall Street Journal

3. The Liquidity Game: Playing volume games

How gaming happens: 1) **The Information Leak (Fishing)**- By selling a few small lots, a gamer determines that a passive buyer has placed a standing order in a stock 2) **The Exploratory Maneuver** - The gamer buys the stock rapidly in the displayed market and succeeds in moving the stock up. 3) **The Hit** - After moving the stock, the gamer sends a large sell order to the dark pool and sells at substantially higher prices than the price he started buying at in the displayed market. 4) **The Reversion** - In less than two minutes it is all over. Prices revert as the gamer stops supporting the market.

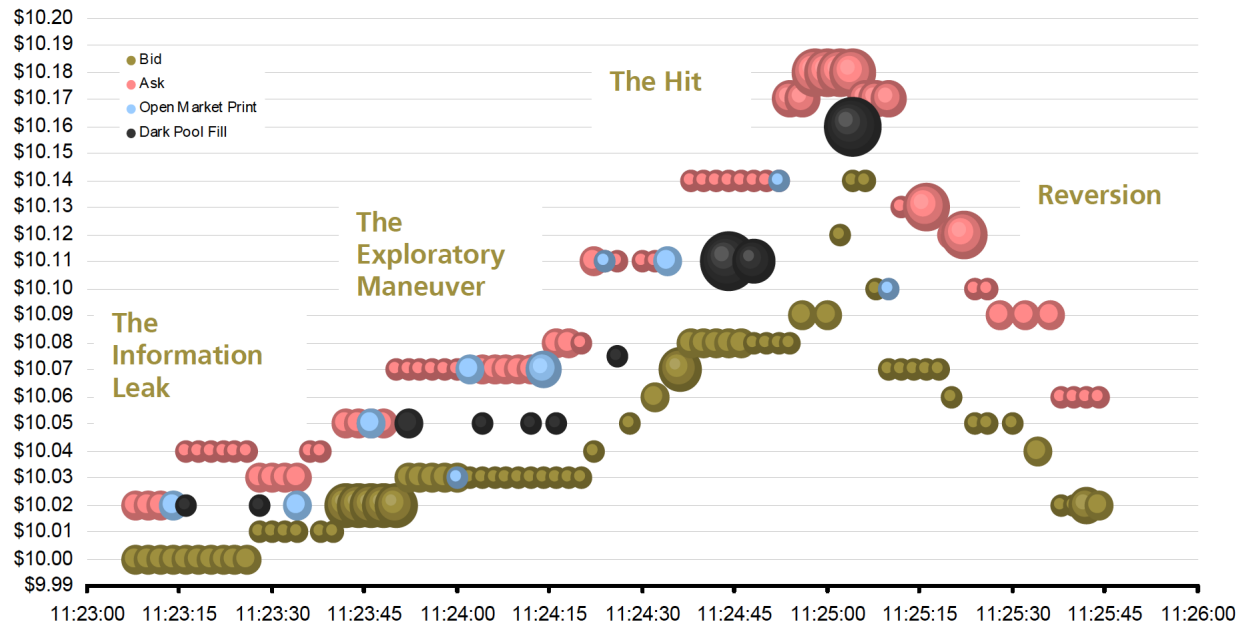

4. Multiples and Comparable Transactions

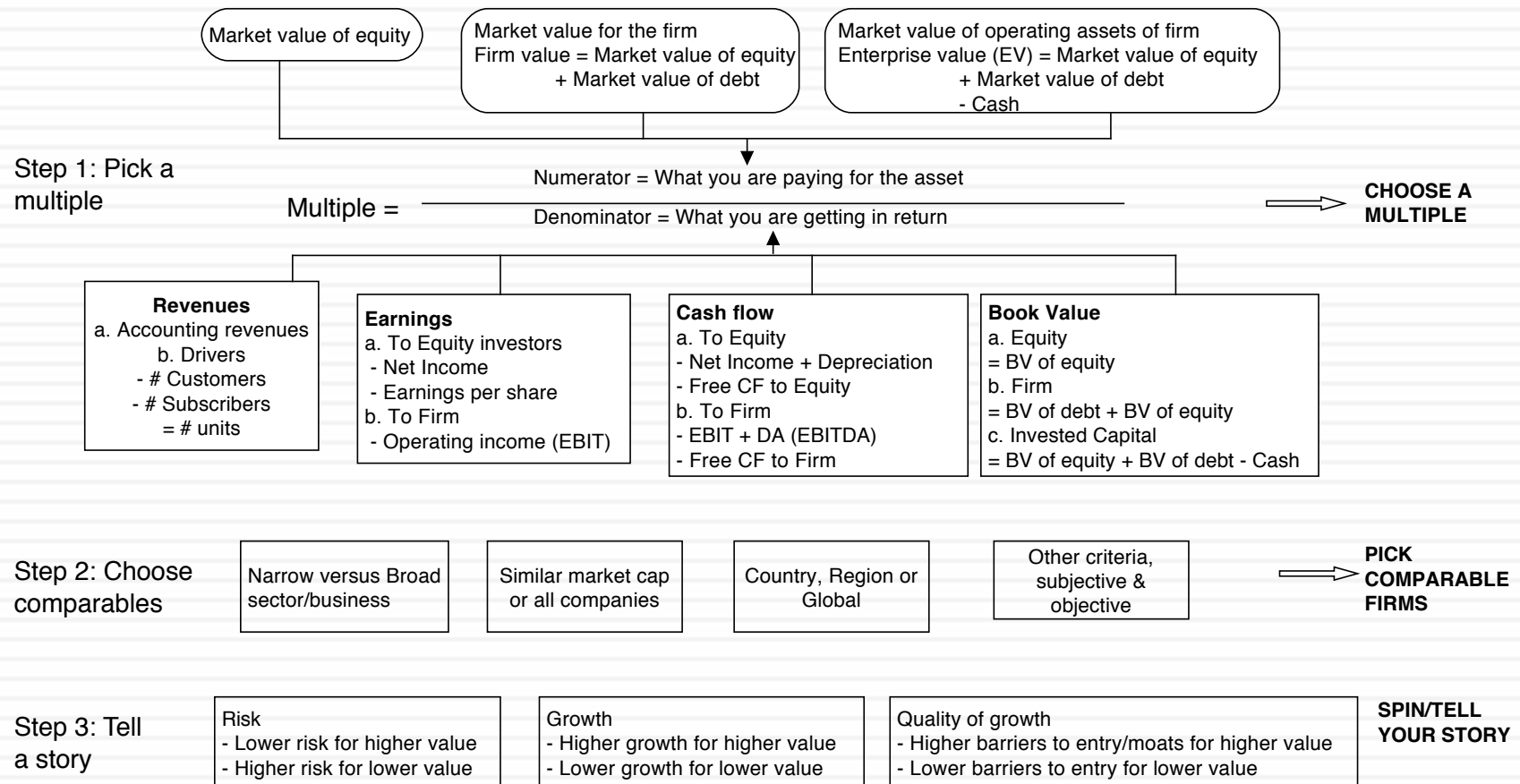

Pricing Twitter: Start with the “comparables”

65

Company	Market Cap	Enterprise value	Revenues	EBITDA	Net Income	Number of users (millions)	EV/User	EV/Revenue	EV/EBITDA	PE
Facebook	\$173,540.00	\$160,090.00	\$7,870.00	\$3,930.00	\$1,490.00	1230.00	\$130.15	20.34	40.74	116.47
Linkedin	\$23,530.00	\$19,980.00	\$1,530.00	\$182.00	\$27.00	277.00	\$72.13	13.06	109.78	871.48
Pandora	\$7,320.00	\$7,150.00	\$655.00	-\$18.00	-\$29.00	73.40	\$97.41	10.92	NA	NA
Groupon	\$6,690.00	\$5,880.00	\$2,440.00	\$125.00	-\$95.00	43.00	\$136.74	2.41	47.04	NA
Netflix	\$25,900.00	\$25,380.00	\$4,370.00	\$277.00	\$112.00	44.00	\$576.82	5.81	91.62	231.25
Yelp	\$6,200.00	\$5,790.00	\$233.00	\$2.40	-\$10.00	120.00	\$48.25	24.85	2412.50	NA
Open Table	\$1,720.00	\$1,500.00	\$190.00	\$63.00	\$33.00	14.00	\$107.14	7.89	23.81	52.12
Zynga	\$4,200.00	\$2,930.00	\$873.00	\$74.00	-\$37.00	27.00	\$108.52	3.36	39.59	NA
Zillow	\$3,070.00	\$2,860.00	\$197.00	-\$13.00	-\$12.45	34.50	\$82.90	14.52	NA	NA
Trulia	\$1,140.00	\$1,120.00	\$144.00	-\$6.00	-\$18.00	54.40	\$20.59	7.78	NA	NA
Tripadvisor	\$13,510.00	\$12,860.00	\$945.00	\$311.00	\$205.00	260.00	\$49.46	13.61	41.35	65.90
						Average	\$130.01	11.32	350.80	267.44
						Median	\$97.41	10.92	44.20	116.47

Read the tea leaves: See what the market cares about

	<i>Market Cap</i>	<i>Enterprise value</i>	<i>Revenues</i>	<i>EBITDA</i>	<i>Net Income</i>	<i>Number of users (millions)</i>
<i>Market Cap</i>	1.					
<i>Enterprise value</i>	0.9998	1.				
<i>Revenues</i>	0.8933	0.8966	1.			
<i>EBITDA</i>	0.9709	0.9701	0.8869	1.		
<i>Net Income</i>	0.8978	0.8971	0.8466	0.9716	1.	
<i>Number of users (millions)</i>	0.9812	0.9789	0.8053	0.9354	0.8453	1.

Use the “market metric” and “market price”

67

- The most important variable, in late 2013, in determining market value and price in this sector (social media, ill defined as that is) is the number of users that a company has.
- Looking at comparable firms, it looks like the market is paying about \$100/user in valuing social media companies, with a premium for “predictable” revenues (subscriptions) and user intensity.
- Twitter has about 240 million users and can be valued based on the \$100/user:
- Enterprise value = $240 * 100 = \$24$ billion

Poll Question 8: The “best” multiple

68

- Assume that you are pricing a business by looking at comparable businesses and are trying to find the right multiple to use in your pricing. Which of the following multiples is the best one to use?
 - a. A multiple of revenues, since it is positive for all businesses and least affected by accounting choices.
 - b. A multiple of income, since the value of a business ultimately rests on its capacity to generate income.
 - c. A multiple of cash flows, since the value of a business ultimately rests on its capacity to generate cash flows.
 - d. A multiple of whatever metric investors in the sector are focused on at the moment, in pricing businesses.

To be a better pricer, here are four suggestions

- Check your multiple or consistency/uniformity
 - In use, the same multiple can be defined in different ways by different users. When comparing and using multiples, estimated by someone else, it is critical that we understand how the multiples have been estimated
- Look at all the data, not just the key statistics
 - Too many people who use a multiple have no idea what its cross sectional distribution is. If you do not know what the cross sectional distribution of a multiple is, it is difficult to look at a number and pass judgment on whether it is too high or low.
- Don't forget the fundamentals ultimately matter
 - It is critical that we understand the fundamentals that drive each multiple, and the nature of the relationship between the multiple and each variable.
- Don't define comparables based only on sector
 - Defining the comparable universe and controlling for differences is far more difficult in practice than it is in theory.

1. Check the Multiple

- Is the multiple consistently defined?
 - The consistency principle: Both the value (the numerator) and the standardizing variable (the denominator) should be to the same claimholders in the firm. In other words, the value of equity should be divided by equity earnings or equity book value, and firm value should be divided by firm earnings or book value.
 - The cost of mismatching: Assets that are not cheap(expensive) will look cheap (expensive), because your mismatch will skew the numbers.
- Is the multiple uniformly estimated?
 - The uniformity rule: The variables used in defining the multiple should be estimated uniformly across assets in the “comparable firm” list.
 - The cost of ignoring this rule: You will be comparing non-comparable numbers and drawing all the wrong conclusions.

Let's try these definitional rules: PE ratio

$$\text{PE} = \text{Market Price per Share} / \text{Earnings per Share}$$

- There are a number of variants on the basic PE ratio in use. They are based upon how the price and the earnings are defined.

Price: is usually the current price

is sometimes the average price for the year

EPS: EPS in most recent financial year

EPS in trailing 12 months (Trailing PE)

Forecasted EPS in next year (Forward PE)

Forecasted EPS in future year

- Even though PE ratios are consistent at their most general level, there are sub-level consistency tests that you have to meet including:
 - ▣ Should you use primary, diluted or partially diluted earnings per share?
 - ▣ What do you do about cash balances at companies and the effects they have on market capitalization and earnings?

2. Play Moneyball: Let the numbers talk (not the analysts)

- What is the average and standard deviation for this multiple, across the universe (market)?
- What is the median for this multiple?
 - The median for this multiple is often a more reliable comparison point.
- How large are the outliers to the distribution, and how do we deal with the outliers?
 - Throwing out the outliers may seem like an obvious solution, but if the outliers all lie on one side of the distribution (they usually are large positive numbers), this can lead to a biased estimate.
- Are there cases where the multiple cannot be estimated? Will ignoring these cases lead to a biased estimate of the multiple?
- How has this multiple changed over time?

Multiples have skewed distributions...

PE Ratios for US stocks: January 2014

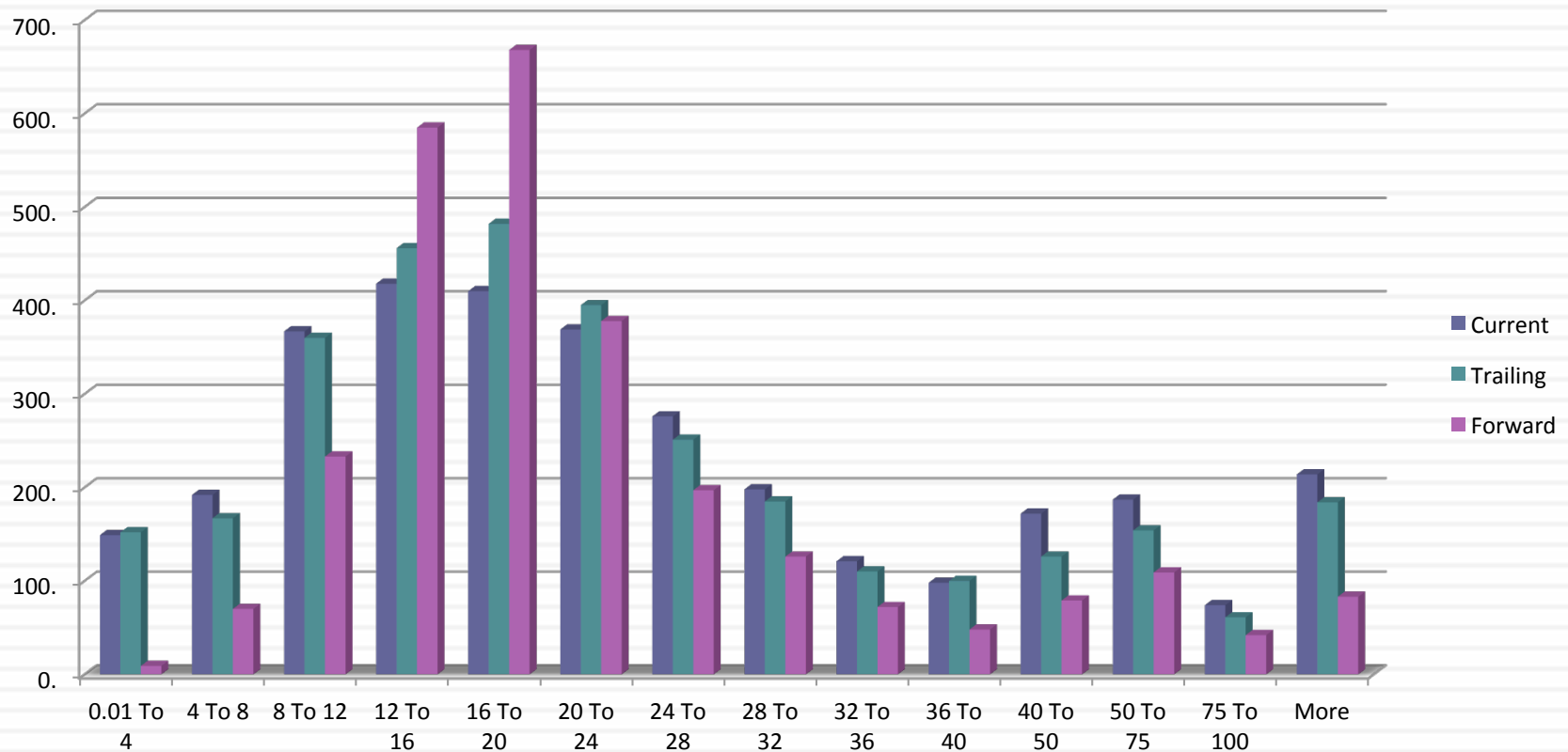

Making statistics “dicey”

74

	<i>Current PE</i>	<i>Trailing PE</i>	<i>Forward PE</i>
Number of firms	7766	7766	7766
Number with PE	3248	3186	2699
Average	52.13	50.14	38.62
Median	20.78	19.75	18.54
Minimum	0.25	0.4	0.52
Maximum	7,117.43	7,117.43	16,820.
Standard deviation	242.03	249.64	349.38
Standard error	4.25	4.42	6.72
Skewness	18.29	17.62	42.99
25th percentile	13.004	12.97	14.7
75th percentile	33.66	30.47	25.13

3. Understand your “implicit” assumptions

- What are the fundamentals that determine and drive these multiples?
 - Proposition 1: Embedded in every multiple are all of the variables that drive every discounted cash flow valuation - growth, risk and cash flow patterns.
 - In fact, using a simple discounted cash flow model and basic algebra should yield the fundamentals that drive a multiple
- How do changes in these fundamentals change the multiple?
 - The relationship between a fundamental (like growth) and a multiple (such as PE) is seldom linear. For example, if firm A has twice the growth rate of firm B, it will generally not trade at twice its PE ratio
 - Proposition 2: It is impossible to properly compare firms on a multiple, if we do not know the nature of the relationship between fundamentals and the multiple.

PE Ratio: Understanding the Fundamentals

Equity Multiple or Firm Multiple

Equity Multiple

1. Start with an equity DCF model (a dividend or FCFE model)

$$P_0 = \frac{DPS_1}{r - g_n} \qquad P_0 = \frac{FCFE_1}{\text{Cost of equity} - g_n}$$

2. Isolate the denominator of the multiple in the model
3. Do the algebra to arrive at the equation for the multiple

Firm Multiple

1. Start with a firm DCF model (a FCFF model)

$$EV_0 = \frac{FCFF_1}{\text{Cost of capital} - g_n}$$

2. Isolate the denominator of the multiple in the model
3. Do the algebra to arrive at the equation for the multiple

The Determinants of Multiples...

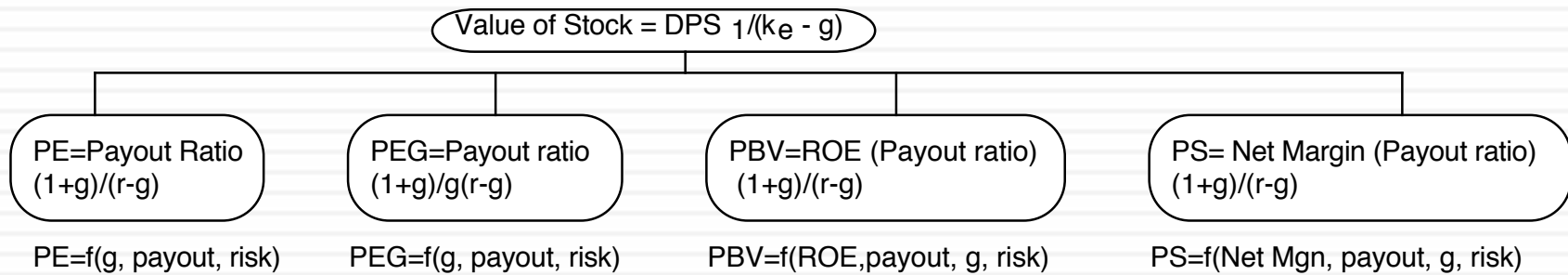

Equity Multiples

Firm Multiples

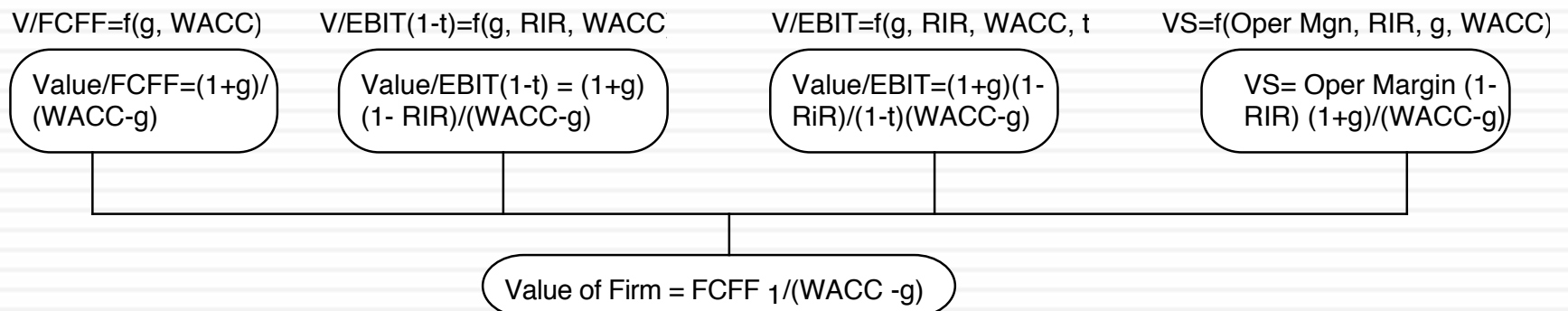

4. Define “comparable” broadly & control for differences

- Given the firm that we are valuing, what is a “comparable” firm?
 - While traditional analysis is built on the premise that firms in the same sector are comparable firms, valuation theory would suggest that a comparable firm is one which is similar to the one being analyzed in terms of fundamentals.
 - Proposition 4: There is no reason why a firm cannot be compared with another firm in a very different business, if the two firms have the same risk, growth and cash flow characteristics.
- Given the comparable firms, how do we adjust for differences across firms on the fundamentals?
 - Proposition 5: It is impossible to find an exactly identical firm to the one you are valuing.

If your job is price enhancement....

The market gives...

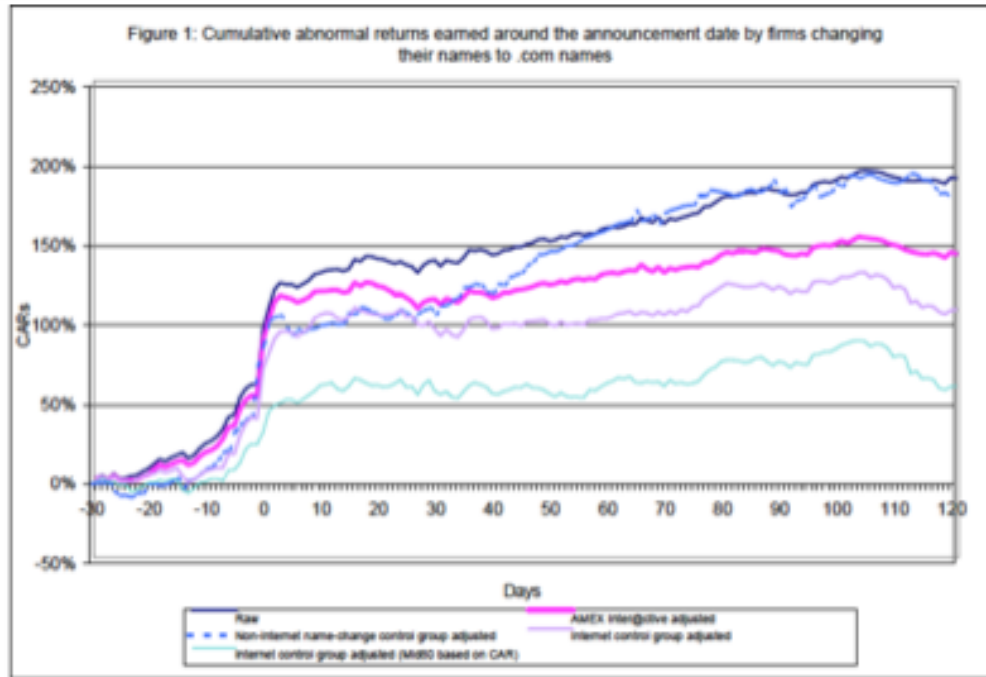

And takes away....





PRICE OR VALUE
WHAT SHOULD YOU DO?

What's your game?

81

- The transactors
 - ▣ Traders: Oscar Wilde's definition of a cynic: "knows the price of everything, the value of nothing".
 - ▣ Salespeople: Caveat emptor!
 - ▣ Deal intermediaries: Get the deal done (even if it is not a good deal)!
- The muddled middle
 - ▣ Academic value: The cognitive dissonance of the "efficient market"
 - ▣ Accounting value: Rule maker, rule maker, make up your mind!
 - ▣ Legal value: The bane of the expert witness!
- The investors
 - ▣ Owners of businesses: Except if you want to run it for the long term.
 - ▣ Investors in companies: With faith and patience, you can take advantage of Mr. Market.
 - ▣ Long term consultants: You have to live with the consequences of the advice that you mete out to your clients.

Sometimes, you don't have a choice..

82

At \$142.4 Million, Triptych Is the Most Expensive Artwork Ever Sold at an Auction



2013 Estate of Francis Bacon/Artists Rights Society (ARS), New York/DACS, London

A fair price for gold? How about value?

83

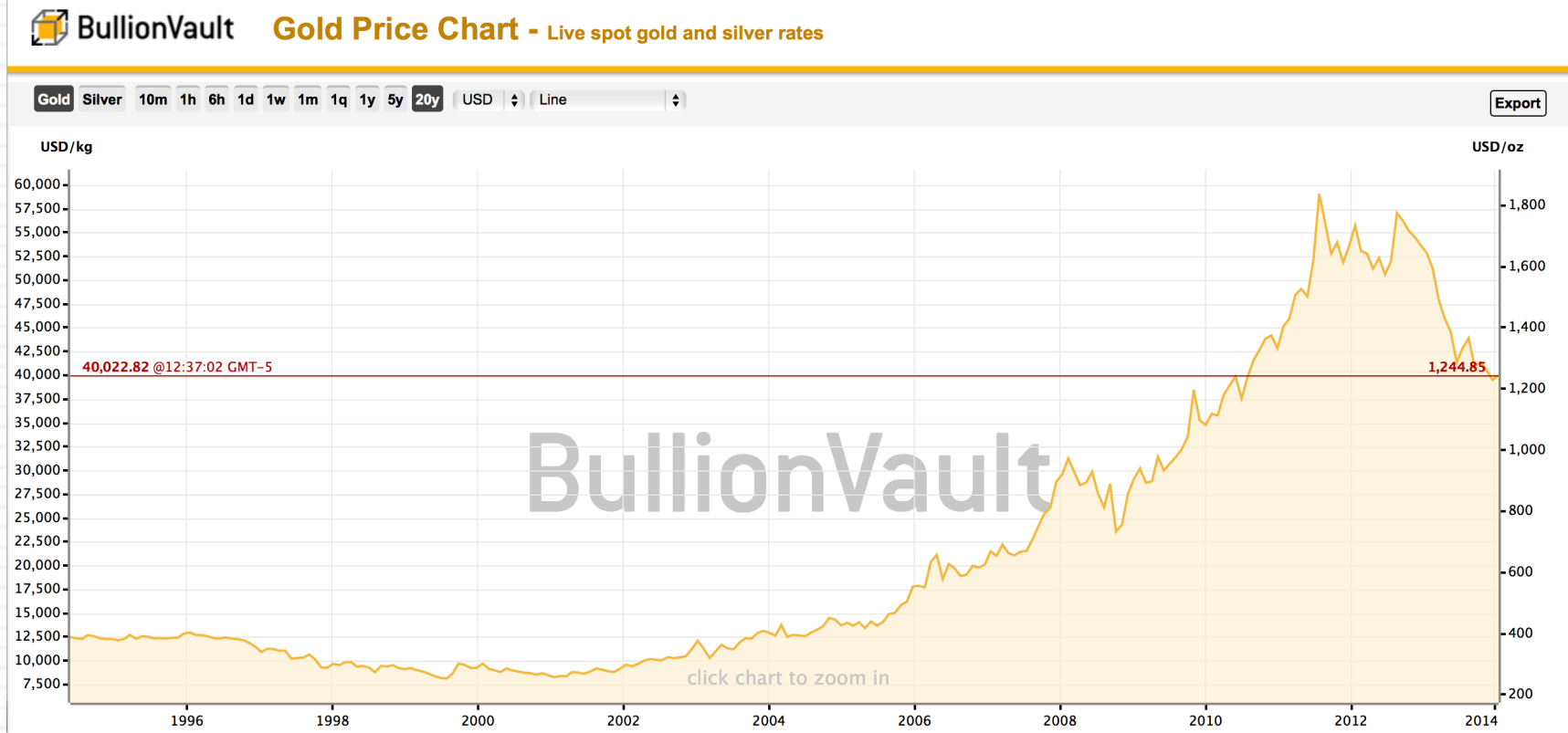

And for Bitcoins?

Bitcoin Price Index Chart

Closing Price ▼

Zoom 1h 12h 1d 1w 1m 3m 1y All From Jul 18, 2010 To Jan 30, 2014



In the muddled middle, what you get is neither price nor value, but mush..

85

- The “fair value accounting” oxymoron: Fair value accounting requires accountants to value assets based upon what “market participants” will pay for those assets in arms length transactions today.
- Legal Valuation: In courts, experts witnesses are generally asked to opine on the values of assets, often in the abstract. It is unclear whether they are being asked to price assets or value assets, and that allows them to stake extreme positions (depending on which side is paying them).
- Academic valuation: Much of what passes for asset pricing in finance is exactly that: pricing.

The Gap

- Tools for intrinsic analysis*
- Discounted Cashflow Valuation (DCF)
 - Intrinsic multiples
 - Book value based approaches
 - Excess Return Models

- Tools for "the gap"*
- Behavioral finance
 - Price catalysts

- Tools for pricing*
- Multiples and comparables
 - Charting and technical indicators
 - Pseudo DCF

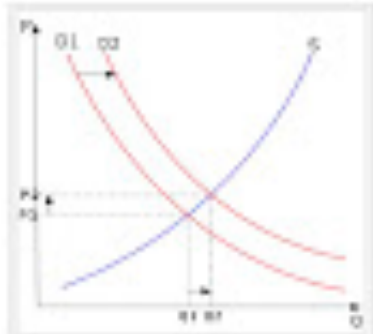
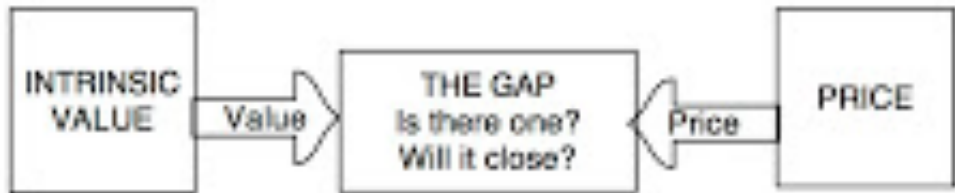

- Drivers of intrinsic value*
- Cashflows from existing assets
 - Growth in cash flows
 - Quality of Growth

- Drivers of "the gap"*
- Information
 - Liquidity
 - Corporate governance

- Drivers of price*
- Market moods & momentum
 - Surface stories about fundamentals

In the investing world, there are three views of “the gap”

87

	View of the gap	Investment Strategies
The Efficient Marketer	The gaps between price and value, if they do occur, are random.	Index funds
The “value” extremist	You view pricers as dilettantes who will move on to fad and fad. Eventually, the price will converge on value.	Buy and hold stocks where value > price and hope that the gap closes.
The pricing extremist	Value is only in the heads of the “eggheads”. Even if it exists (and it is questionable), price may never converge on value.	(1) Look for mispriced securities. (2) Get ahead of shifts in demand/momentum.

If you believe in efficient markets, there is no contradiction

88

- If you believe that markets are efficient, you are not arguing that there will never be gaps between price and value, but that if there are gaps, they are random and cannot be exploited by investors.
- If you buy into this notion, it is indeed appropriate to use price and value as interchangeable, since the market price is your best estimate of the value.

If you are a pure pricer (trader)

89

- Philosophy: The price is the only real number that you can act on. No one knows what the value of an asset is and estimating it is of little use.
- To play the game: You try to guess which direction the price will move in the next period(s) and trade ahead of the movement. To win the game, you have to be right more often than wrong about direction and to exit before the winds shift.
- Key skill: Be able to gauge market mood/momentum shifts earlier than the rest of the market.
- Time Horizon: Can be very short term (minutes) to mildly short term (weeks, months).
- Key personality traits: (a) Market amnesia, (b) Quick acting (c) Gambling instincts.
- Added Bonus: Capacity to move prices (with lots of money and lots of followers)

And here are your dilemmas..

90

- No anchor: If you do not believe in intrinsic value and make no attempt to estimate it, you have no moorings when you invest. You will therefore be pushed back and forth as the price moves from high to low. In other words, everything becomes relative and you can lose perspective.
- Reactive: Without a core measure of value, your investment strategy will often be reactive rather than proactive.
- Crowds are fickle and tough to get a read on: The key to being successful as a pricer is to be able to read the crowd mood and to detect shifts in that mood early in the process. By their nature, crowds are tough to read and almost impossible to model systematically.

To be a pure valuer

91

- Philosophy: Every asset has a fair or true value. You can estimate that value, albeit with error, and price has to converge on value (eventually).
- To play the game: You try to estimate the value of an asset, and if it is under(over) value, you buy (sell) the asset. To win the game, you have to be right about value (for the most part) and the market price has to move to that value.
- Key skill(s): Be able to “value” assets, given uncertainty.
- Time Horizon: As long as it takes for market to correct their mistakes.
- Key personality traits: (a) Faith in “value” (b) Patience (c) immunity from peer pressure.
- Added Bonus: Can provide the catalyst that can move price to value.

And your dilemma...

92

- Uncertainty about the magnitude of the gap:
 - Margin of safety: Many value investors swear by the notion of the “margin of safety” as protection against risk/uncertainty.
 - Collect more information: Collecting more information about the company is viewed as one way to make your investment less risky.
 - Ask what if questions: Doing scenario analysis or what if analysis gives you a sense of whether you should invest.
 - Confront uncertainty: Face up to the uncertainty, bring it into the analysis and deal with the consequences.
- Uncertainty about gap closing: This is tougher and you can reduce your exposure to it by
 - Lengthening your time horizon
 - Providing or looking for a catalyst that will cause the gap to close.

Poll Question 9: Value or Price?

93

- Given what you believe about markets and your assessments of your own personality/strengths, how would you characterize your investment focus?
 - ▣ I am an investor and am driven by value judgments
 - ▣ I am a trader and play the pricing game
 - ▣ I am an investor sometimes and a trader at other times
 - ▣ I am not sure

A case study: Apple in early 2013

94

- Starting in September 2012, when the stock peaked at \$700, the pricing mood turned sour at the company with the stock dropping to \$450 by the end of January 2013.
- In January 2013, I valued the company at about \$600/share, and suggested that it was significantly under valued.
- I also argued that investors were pricing the stock to deliver no growth and have rapidly declining margins and were then punishing the stock for delivering some growth and slowly declining margins.

	<i>Last year</i>	<i>Q2 2013</i>	<i>My estimate</i>	<i>Breakeven</i>
Revenue Growth Rate	44.58%	11.28%	5.00%	-5.00%
Operating Margin	35.30%	28.80%	25.00%	12.00%
Cost of capital	12.49%	11.29%	11.29%	21.00%

Apple: Visualizing uncertainty

A simulation of value in January 2013

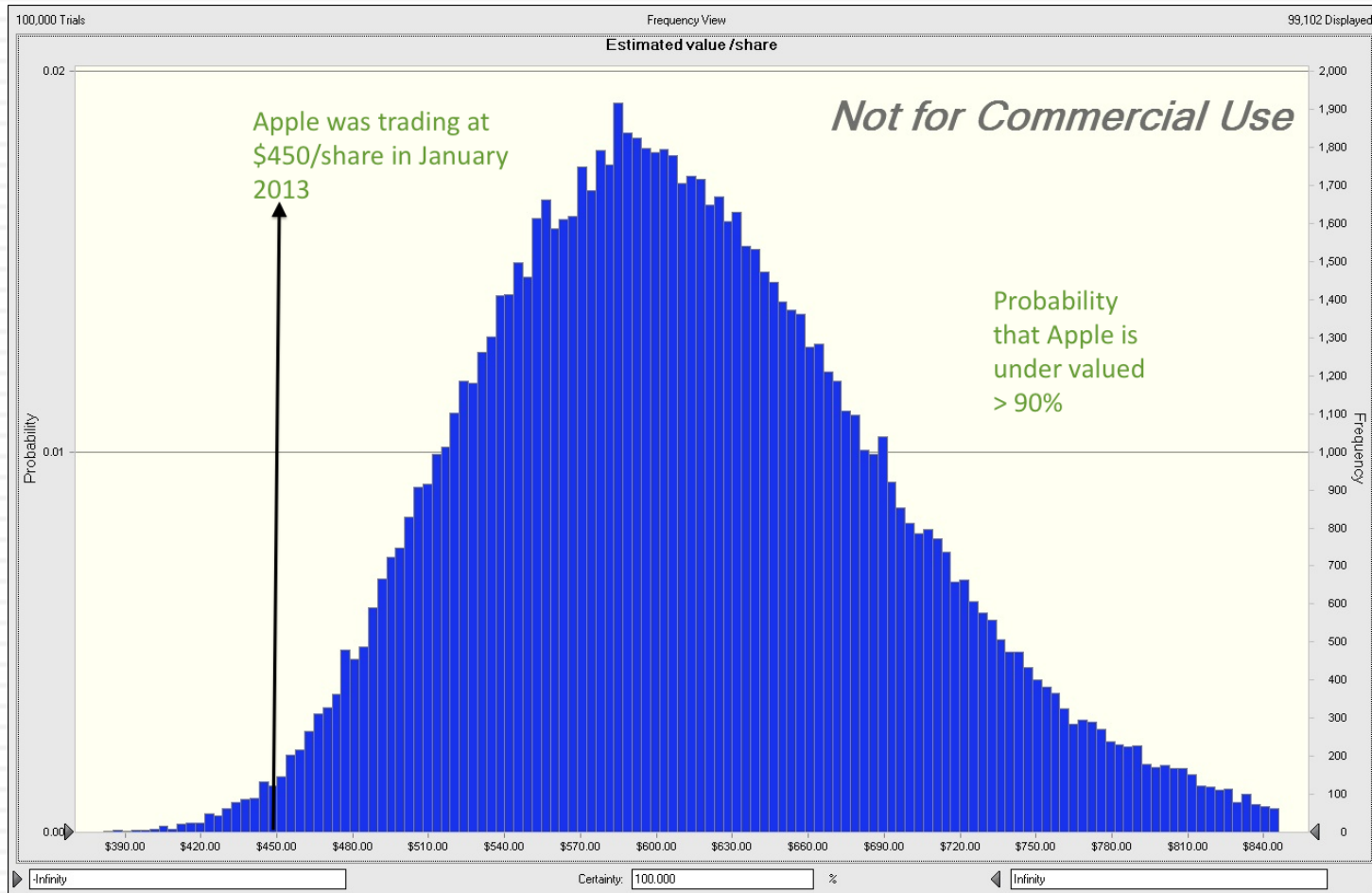

Gap and Time Horizon: My estimates for Apple in January 2013

Apple: Pricing Gap versus Time Horizon in January 2013

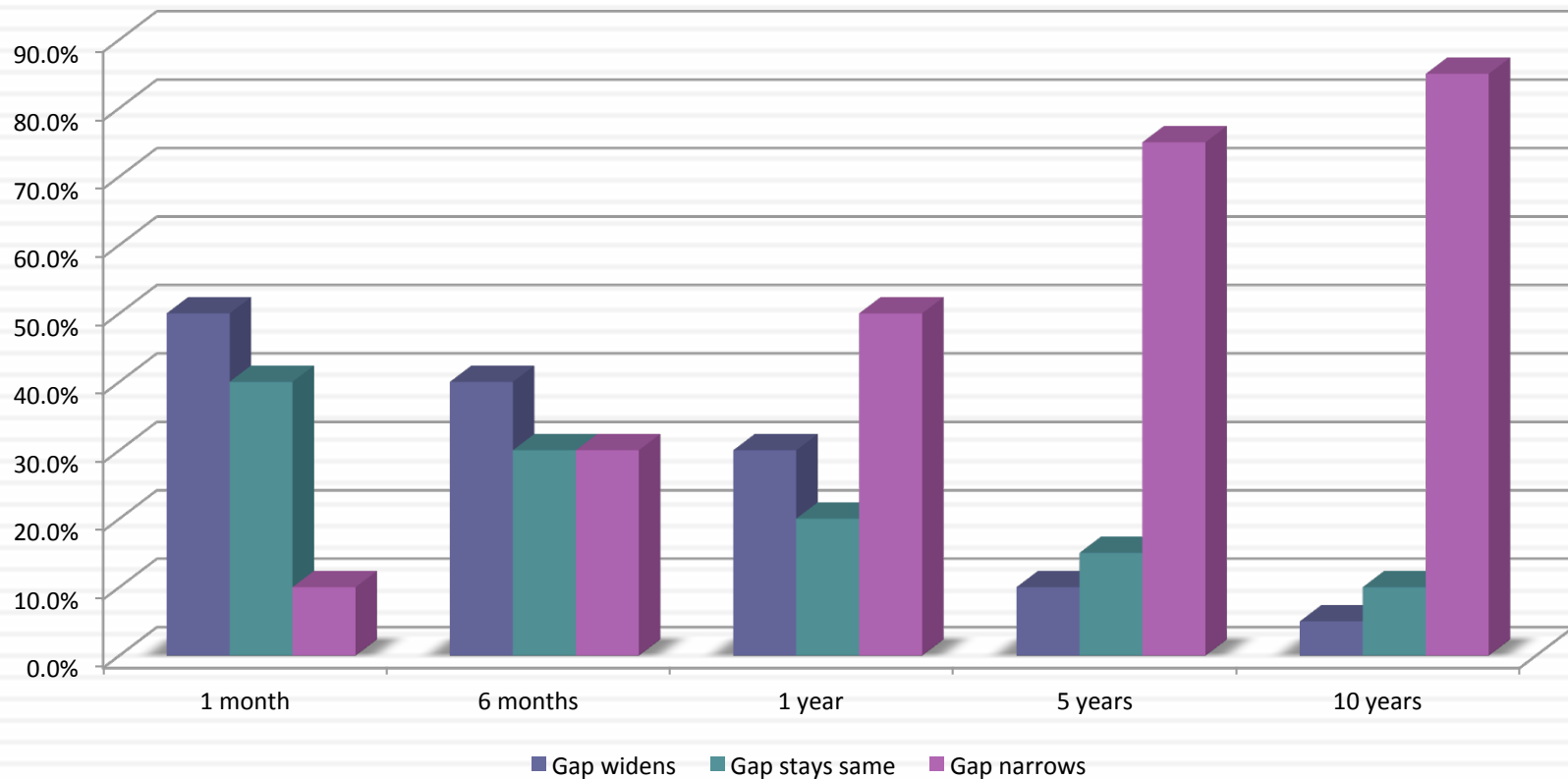

Watch the Gap! Apple updated through September 2014

Apple: Price and Value - 2010 to 2014

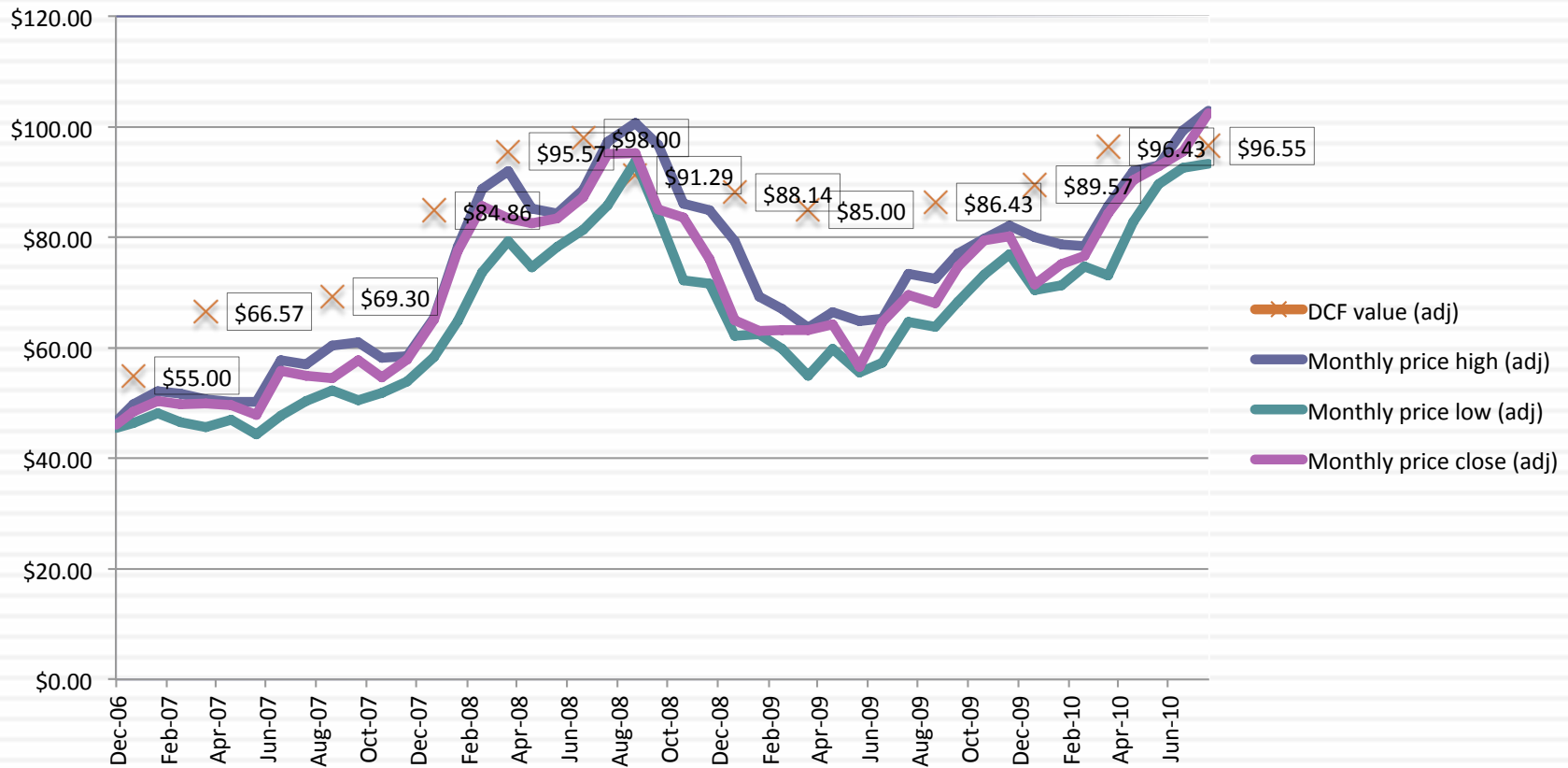

And the uncertainty is greater in some assets (stocks) than others

98

- In which of these two cities would you find it easier to forecast the weather?

Weather changeability for Honolulu, Hawaii

Temperature	Last Month	Last Year
Average change in high temperature day-to-day	1.7°	1.2°
Average change in low temperature day-to-day	1.5°	2.0°

Precipitation	Last Month	Last Year
Chance of dry day after a precip day	67%	81%
Chance of precip day after a dry day	7%	13%

Weather changeability for Epping, North Dakota

Temperature	Last Month	Last Year
Average change in high temperature day-to-day	8.5°	7.7°
Average change in low temperature day-to-day	7.1°	8.6°

Precipitation	Last Month	Last Year
Chance of dry day after a precip day	50%	65%
Chance of precip day after a dry day	38%	20%

But the payoff is greatest where there is the most uncertainty...

Weather changeability for Honolulu, Hawaii

Temperature	Last Month	Last Year	Precipitation	Last Month	Last Year
Average change in high temperature day-to-day	1.7°	1.2°	Chance of dry day after a precip day	67%	81%
Average change in low temperature day-to-day	1.5°	2.0°	Chance of precip day after a dry day	7%	13%

[Further changeability analysis >](#)

Weather forecast accuracy for Honolulu, Hawaii

Last Month		Last Year	
MeteoGroup	88.44%	MeteoGroup	88.50%
Persistence	81.80%	CustomWeather	85.87%
CustomWeather	78.23%	AccuWeather	81.82%
The Weather Channel	73.12%	The Weather Channel	81.56%
AccuWeather	69.89%	Persistence	80.44%
Weather Underground	62.10%	Weather Underground	67.07%
National Weather Service	48.39%	National Weather Service	59.90%
Foreca	44.35%	Foreca	57.52%
WeatherBug	32.26%	WeatherBug	37.09%

Weather changeability for Epping, North Dakota

Temperature	Last Month	Last Year	Precipitation	Last Month	Last Year
Average change in high temperature day-to-day	8.5°	7.7°	Chance of dry day after a precip day	50%	65%
Average change in low temperature day-to-day	7.1°	8.6°	Chance of precip day after a dry day	38%	20%

[Further changeability analysis >](#)

Weather forecast accuracy for Epping, North Dakota

Last Month		Last Year	
MeteoGroup	62.50%	MeteoGroup	66.97%
Foreca	61.61%	The Weather Channel	66.73%
The Weather Channel	61.31%	AccuWeather	64.86%
AccuWeather	60.42%	WeatherBug	64.80%
Weather Underground	56.85%	Foreca	62.75%
WeatherBug	56.17%	CustomWeather	62.70%
National Weather Service	54.76%	National Weather Service	62.64%
CustomWeather	54.46%	Weather Underground	61.38%
Persistence	38.01%	Persistence	44.09%

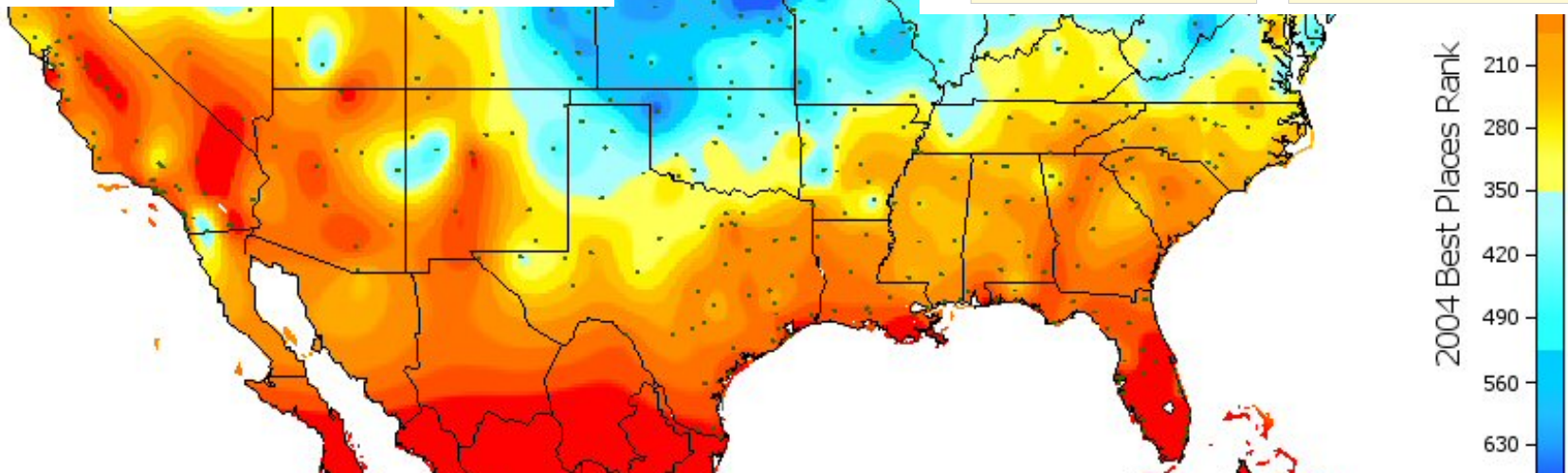

Three rules for the road

100

1. Do your job: There is no right or wrong way to put a number on an asset. If your job is to price it, that is exactly what you should do. If it is to value it, go for an intrinsic value approach.
2. Don't be delusional: If you are pricing an asset, don't get distracted too much by fundamentals and intrinsic value concerns. If you are valuing an asset, don't let the pricing process (mood & momentum) feed back into your valuation.
3. Play to your strengths: To be a successful investor, you have to know what makes you tick and pick the approach that best fits you.